

IRPLDIM4E

Miniature Dimmable 26W Ballast Using IRS2530D *DIM8*TM Control IC

Table of Contents

	Page
1. Overview	2
2. Features	2
3. Electrical Characteristics	3
4. Fault Protection Characteristics	3
5. IRS2530D <i>DIM8</i> TM Ballast Control IC	4
6. Circuit Description	4
7. Circuit Schematics	5
8. Bill of Materials	6
9. Functional Description	7
10. Fault Conditions	10
11. PCB Layout and Component Placement	14
12. Inductor Specifications	17

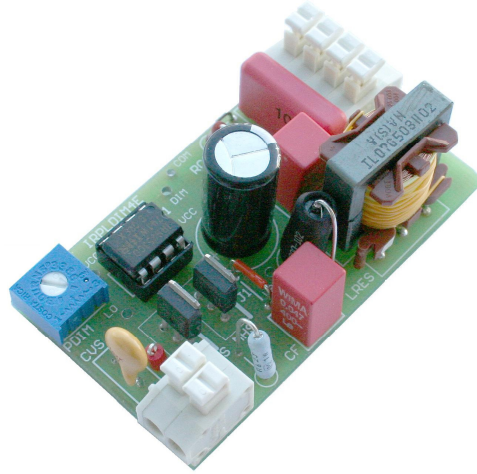

1. Overview

The IRPLDIM4E Reference Design is a miniature dimmable electronic ballast for driving 26W compact fluorescent lamps from a 220VAC line. The circuit provides all of the necessary functions for preheat, ignition, and dimming control of the lamp and also includes the EMI filter and AC rectification stage. The ballast size is 1.42in x 2.44in (36mm x 62mm).

The circuit is designed around the [IRS2530D\(S\)PbF DIM8™](#) Ballast Control IC. The IRS2530D includes adjustable preheat time, frequency sweeping for filament preheating and lamp ignition, a dimming reference and feedback input, a high soft-start frequency to avoid lamp flash, lamp and ballast fault protection for open filament condition, failure to strike, and no lamp fault conditions, automatic restart during lamp exchange, and, low AC line protection. The IRS2530D is simple to use, has only 8 pins, and drastically reduces component count for a complete dimming solution.

2. Features

- Closed-loop dimming control
- Programmable preheat time
- Frequency sweep for filament preheat and lamp ignition
- Open filaments and no-lamp protection
- Failure to strike and deactivated-lamp protection
- Low AC line protection
- Lamp exchange auto restart

3. Electrical Characteristics

Parameter	Units	Dimming Level	Value
Lamp Type			26W CFL
Input Power	[W]	100%	25
		10%	9
Input Current	[mArms]	100%	180
		10%	78
Lamp Running Voltage	[Vpp]	100%	320 [†]
		10%	480
Lamp Running Current	[mArms]	100%	271
		10%	26
Start Frequency	[kHz]		115
Run Frequency	[kHz]	100%	42
		10%	68
Preheat Time	[s]		1
Input AC Voltage Range	[VACrms]		200 - 250
Ballast turn-off voltage	[VACrms]		85

TABLE 3.1: Ballast Parameters.

† The lamp running voltage at 100% dimming level is not perfectly sinusoidal and has some distortion.

4. Fault Protection Characteristics

Fault	Protection	Ballast	Restart Operation
Brown-out	Non-ZVS	Increase frequency	Line voltage increase
Upper filament broken	Crest Factor Over Current	Deactivates	Lamp exchange
Lower filament broken	Crest Factor Over Current	Deactivates	Lamp exchange
Lamp removed	Crest Factor Over Current	Deactivates	Lamp inserted
Failure to ignite	VVCOFLT+	Deactivates	Lamp exchange
No lamp	VLOSD-	Does not start	Lamp inserted
End of life	Crest Factor Over Current	Deactivates	Lamp exchange

TABLE 4.1: Fault Protections Characteristics.

5. IRS2530D DIM8™ Ballast Control IC

The IRS2530D is an application specific solution for dimming CFL and TL lamps in CFL or matchbox (small size ballasts) applications. It integrates all of the necessary functions for preheat, ignition and dimming control of the lamp, plus lamp fault protection, low AC-line protection, lamp exchange auto-restart, and a 600V half-bridge driver into a standard SO8 or DIP8 package.

The IRS2530D includes adaptive zero-voltage switching, non-zero voltage switching (ZVS) protection, as well as an integrated 600V bootstrap MOSFET. The heart of this IC is a voltage-controlled oscillator (VCO) with a dimming reference/feedback input. One of the biggest advantages of the IRS2530D is that it uses the VS pin (the mid-point of the half-bridge) for over-current protection and to detect non-ZVS conditions. The IRS2530D uses the RDSon of the low-side half-bridge MOSFET for current sensing each cycle when the low-side MOSFET is on. An internal 600V MOSFET connects the VS pin to the VS-sensing circuitry and allows for the VS pin to be accurately measured during the time when pin LO is high, while withstanding the high DC bus voltage during the other portion of the switching cycle when the high-side MOSFET is turned on. This eliminates the need for an external, precision current sensing resistor that is typically used to detect over-current. Please refer to the IRS2530D datasheet for further information including electrical parameters, a state diagram and a complete functional description.

As a result of the IRS2530D features, the IRPLDIM4E Reference Design is a complete dimming ballast solution that includes lamp fault protection, low AC line protection, lamp exchange auto-restart, and reduces component count and ballast size.

6. Circuit Description

The schematic for IRPLDIM4E is shown in Figure 7.1. The bill of materials with the component values is shown in Table 8.1.

The ballast incorporates a fuse, input rectifier, EMI filter, bus capacitor, half-bridge, dimming control and output stage. The output stage is a series-L, parallel-RC resonant circuit consisting of an inductor (LRES), capacitor (CRES), and lamp. The AC line input voltage is rectified to provide a bus voltage of approximately 300VDC. The start-up resistors, RVCC1 and RVCC2, are sized such that they supply the micro-power current during under-voltage lockout (UVLO) mode and determine the AC line voltage where the ballast turns-on. When VCC exceeds the startup threshold (VCCUV+), the IRS2530D begins to oscillate and the charge pump circuit (CVS, DCP1 and DCP2) supplies the current to VCC while maintaining the internal VCC zener clamp at 15.6V.

The IRS2530D controls the frequency of the half-bridge for satisfying the lamp operating modes. These include lamp preheat, lamp ignition, dimming, low AC line protection and lamp/ballast fault protection.

7. Circuit Schematic

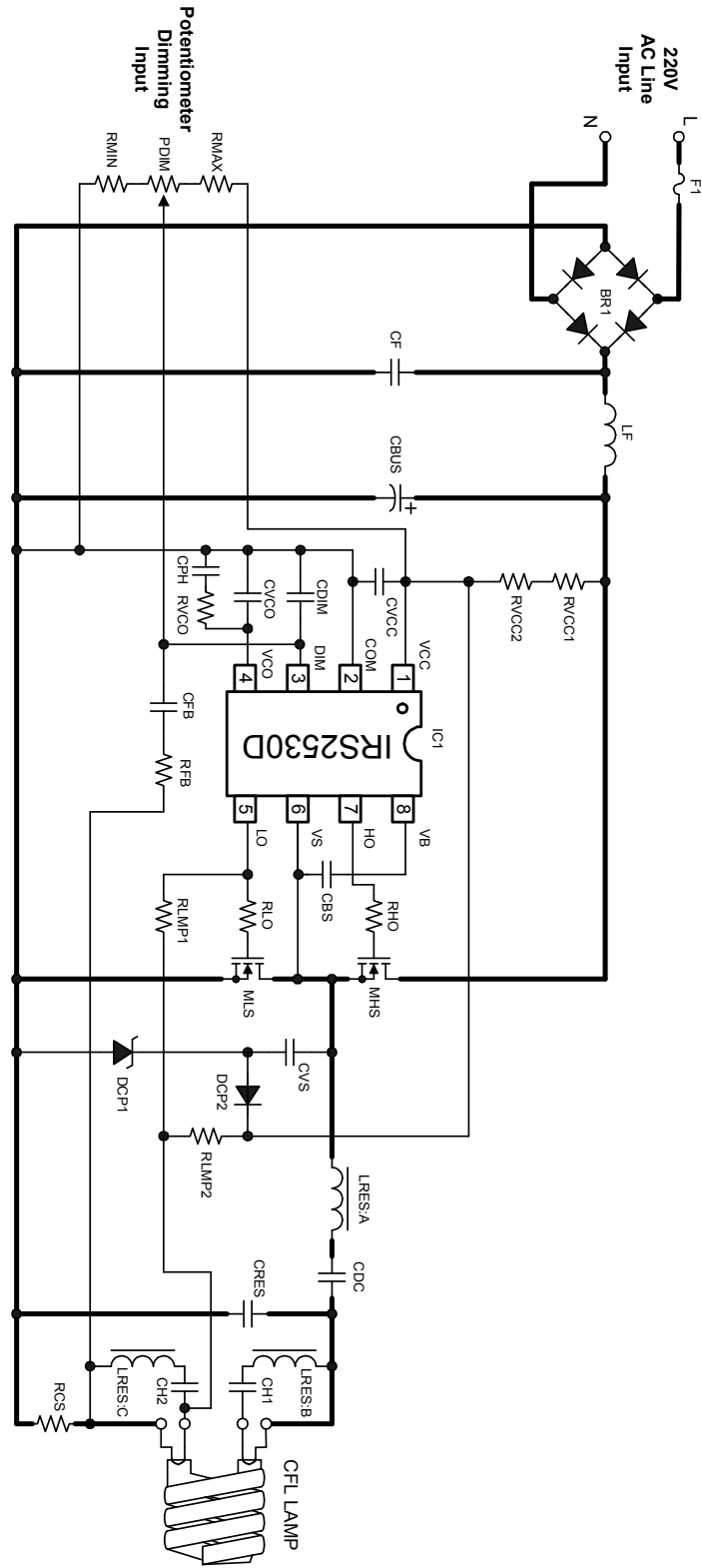

Figure 7.1: IRPLDIM4E Circuit Schematic

8. Bill of Materials

Item #	Qty	Manufacturer	Part Number	Description	Reference
1	1	Digikey Diodes, Inc.	RH06DICT-ND RHO6-T	Bridge Rectifier, 600V, 0.5A MiniDip	BR1
2	1	Digikey Vishay	PPC.47BCT-ND NFR25H0004707JR500	Resistor, 0.47R, 1/2W	F1
3	1	Digikey Epcos	M8301-ND 5800-102-RC	RF Chokes 1mH 200mA	LF
4	2	Wima	MKS2 Series	Capacitor, 47nF, 400V	CF, CDC
5	1	Digikey Panasonic	P5931-ND EEU-EB2V100	Capacitor, 10µF, 350VDC, 105C	CBUS
6	2	Digikey Panasonic	PCC104BCT-ND ECJ-3VB1H104K	Capacitor, 0.1µF, 50V, 1206	CBS, CFB
7	2	Digikey Panasonic	PCC1886CT-ND ECJ-3VB1E184K	Capacitor, 0.18µF, 25V, 1206	CH1, CH2
8	1	Digikey Yageo	311-1171-1-ND CC1206KRX7R9BB222	Capacitor, 2.2nF, 50V, 1206	CVCO
9	1	Digikey Panasonic	PCC1892CT-ND ECJ-3YBIE684K	Capacitor, 0.68µF, 25V, 1206	CPH
10	1	Digikey Panasonic	PCC1882CT-ND ECJ-3YB1C105K	Capacitor, 1µF, 16V, 1206	CVCC
11	1	Digikey Yageo	311-1174-1-ND CC1206KRX7R9BB103	Capacitor, 10nF, 50V, 1206	CDIM
12	1	Digikey Panasonic	P9542-ND ECK-A3A102KBP	Capacitor, 1nF, 1KV, Ceramic disk	CVS
13	1	Wima TAW	MKP-10 RM15MM MKP 472K1K6	Polypropylene Capacitor, 4.7nF/1.6KV, 10%, RM=15mm	CRES
14	1	IR	IRS2530D	Dimming Ballast Control IC	IC1
15	1	Vogt	IR IL 070 503 11 02	Ballast Resonant Inductor EF20, 2.3mH	LRES
16	2	Digikey/Vishay	IRFU320	Transistor, MOSFET, 400V	MHS, MLS
17	2	Digikey Panasonic	P360KECT-ND ERJ-8GEYJ364V	Resistor, 360K, 1206	RVCC1, RVCC2
18	1	Digikey Panasonic	PPC7.5W-1CT-ND 5073NW7R500J12AFX	Resistor, 7.5 Ohm, 5%, 1 W, Axial	RCS
19	1	Digikey Panasonic	P220KECT-ND ERJ-8GEYJ224V	Resistor, 220K, 1206	RLMP1
20	1	Digikey Panasonic	P470KECT-ND ERY-8GEYJ474V	Resistor, 470K, 1206	RLMP2
21	1	Digikey Panasonic	RHM430FCT-ND MCR18EZH4300	Resistor, 430 Ohm, 1%, 1206	RMIN
22	1	Digikey Panasonic	P200KFCT-ND ERJ-8ENF2003V	Resistor, 200K, 1%, 1206	RMAX
23	1	Digikey Panasonic	P1.0KALCT-ND ERJ-P08J102V	Resistor, 1K, 1206	RFB
24	1	Digikey Yageo	311-1.5KERCT-ND RC1206JR-071K5L	Resistor, 1.5K, 1206	RVCO
25	2	Digikey Panasonic	P10ECT-ND ERJ-8GEYJ100V	Resistor, 10 Ohm, 1206	RHO, RLO
26	1	Digikey Bourns	3386P-103LF-ND 3386P-1-103LF	Pot, 10K, Single turn	PDIM
27	1	Digikey Diodes, Inc.	LL4148DICT-ND	Diode, 1N4148 SMT DL35	DCP2
28	1	Digikey Diodes, Inc.	ZMM5248BDICT-ND ZMM2548B-7	Zener Diode, 18V, 500mV, SMT	DCP1
29	1			Wire Jumper	J1
30	1	WAGO	235-202	Connector, 2 terminal	X1
31	1	WAGO	235-204	Connector, 4 terminal	X2
32	1	IR	IRPLDIM4E	PCB, Single Layer	
Total	38				

TABLE 8.1: IRPLDIM4E Bill of Materials. Lamp type: Spiral CFL 26W, Line Input Voltage: 200 - 250 VAC. Note: Different lamp types may require components with different values, voltage ratings and/or current ratings.

9. Functional Description

When power is turned on, the IRS2530D first starts in Under Voltage Lockout (UVLO) mode. The UVLO mode is designed to maintain an ultra-low ($<250\mu\text{A}$) supply current, and to guarantee that the IC is fully functional before the high- and low-side output (HO and LO) gate drivers are activated. During UVLO, HO is 'low', and VCO is pulled down to COM for resetting the starting frequency to the maximum. LO is open circuit, and is used as a shutdown/reset input function for automatically restarting the IC when a lamp has been removed and re-inserted.

Once VCC reaches the startup threshold (V_{CCUV+}) and the LO pin is below V_{LOSD-} (lamp is inserted), the half-bridge FETs start to oscillate and the IC enters Preheat/Ignition Mode. At startup, VCO is 0V and the frequency starts at f_{MAX} . The frequency ramps down towards the resonant frequency of the high-Q ballast output stage, causing the lamp voltage to increase. During this time, the filaments of the lamp are pre-heated to their emission temperature to minimize the necessary ignition voltage and to increase lamp life. The voltage on pin VCO continues to increase and the frequency keeps decreasing until the lamp ignites. If the lamp ignites successfully, the IRS2530D enters the DIM mode. The resonant output stage transitions to a series-L, parallel RC circuit with the Q-value and operating point determined by the user dim level (Figure 9.1)

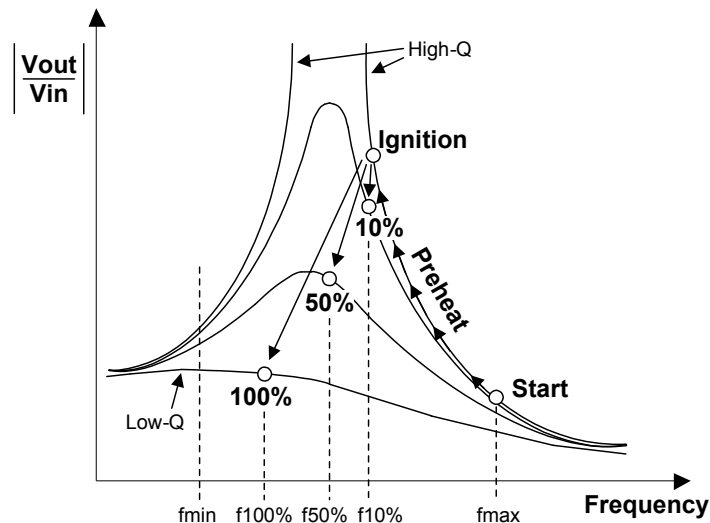

Figure 9.1: Resonant tank Bode plot with lamp dimming operating points

Figure 9.2 shows the VCO voltage, the voltage across the lamp, and the current through the lamp during Preheat, Ignition, and Dim mode for 100% dimming level. Figure 9.3 shows these waveforms for 10% dimming level.

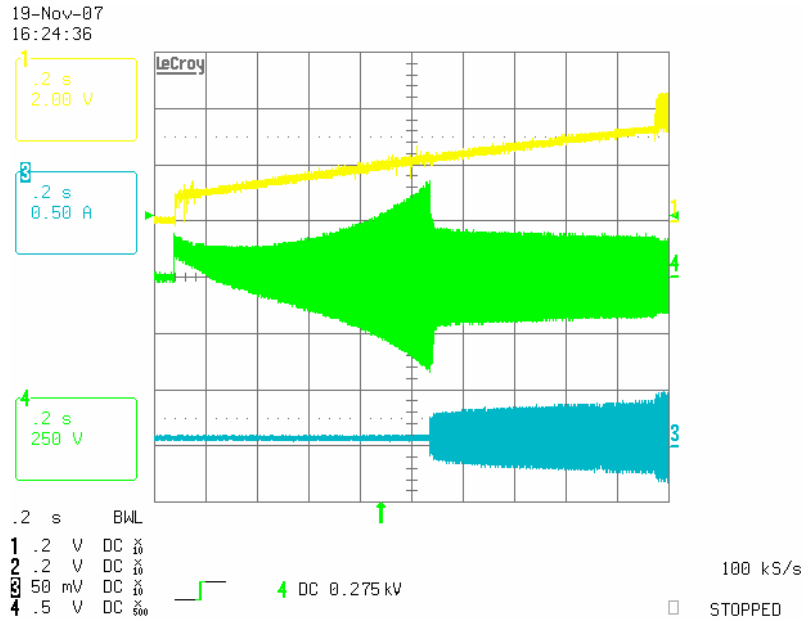

Figure 9.2: Preheat, Ignition, and Dim mode for 100% dimming level: CH1 is the VCO voltage, CH3 is the lamp current, and CH4 is the voltage across the lamp

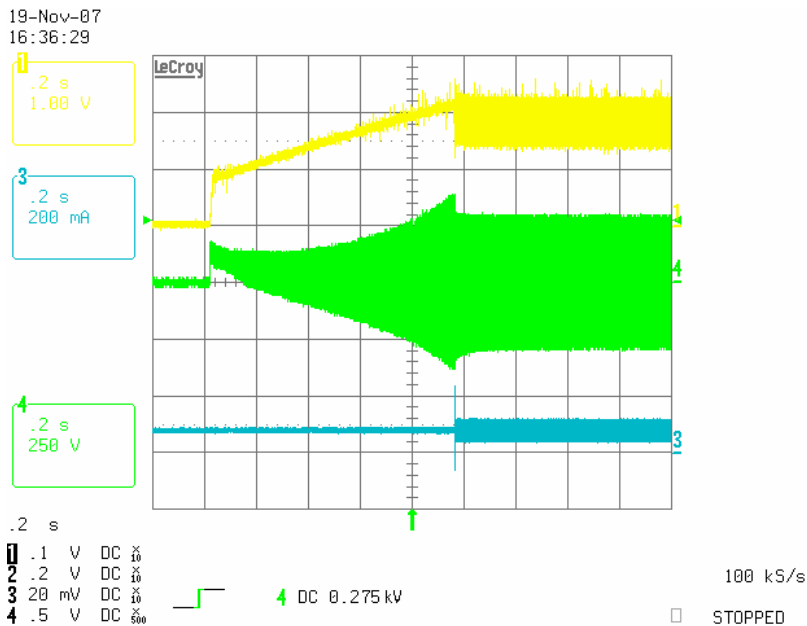

Figure 9.3: Preheat, Ignition, and Dim mode for 10% dimming level: CH1 is the VCO voltage, CH3 is the lamp current, and CH4 is the voltage across the lamp

Figure 9.4 shows the voltage at the DIM pin, the VS (half-bridge) voltage, and the voltage at the VCO pin during Dim Mode for 100% dimming level. Figure 9.5 shows these voltages for 10% dimming level.

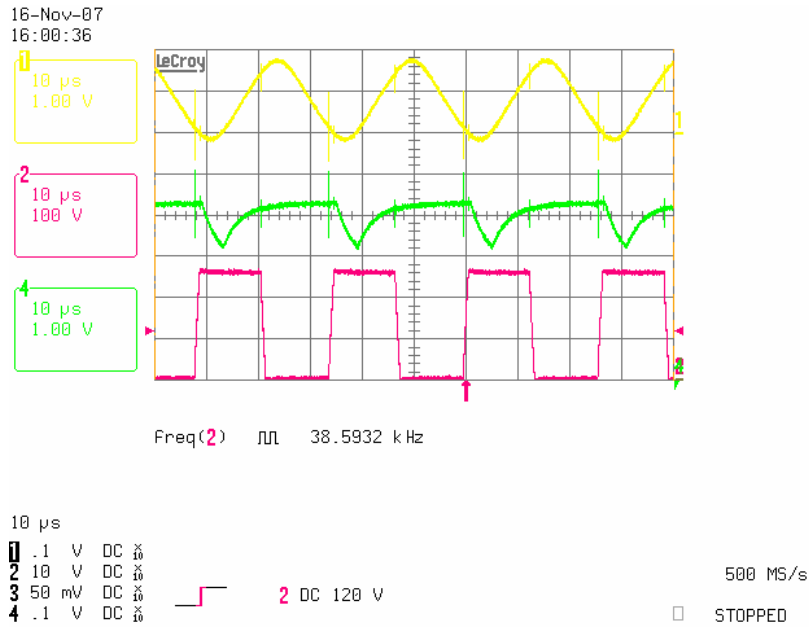

Figure 9.4: 100% dimming level waveforms: CH1 is the DIM voltage, CH2 is the voltage at VS pin, and CH4 is the VCO voltage

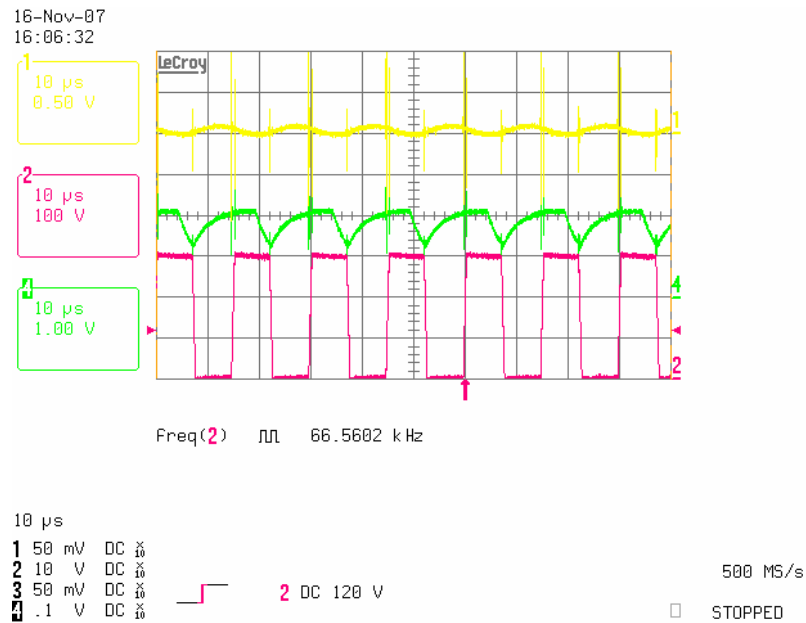

Figure 9.5: 10% dimming level waveforms: CH1 is the DIM voltage, CH2 is the voltage at VS pin, and CH4 is the VCO voltage

10. Fault Conditions

In case of fault conditions such as open filaments, failure to strike, or lamp removal, the IRS2530D will go into Fault Mode. In this mode, the internal fault latch is set, HO is off, LO is open circuit, and the IRS2530D consumes an ultra-low micro-power current. The IRS2530D can be reset with a lamp exchange (as detected by the LO pin) or a recycling of VCC below and back above the UVLO thresholds.

Failure to Strike

At initial turn-on of the ballast, the frequency will ramp down from f_{MAX} toward the resonance frequency. When the lamp fails to strike, the VCO voltage continues to increase and the frequency continues to decrease until the VCO voltage exceeds VVCOFLT+ (4.0V, typical), and the IRS2530D enters Fault Mode and shuts down (Figure 10.1). It should be noted that in case of failure to strike, the system will operate in capacitive side of resonance, but only for short period of time.

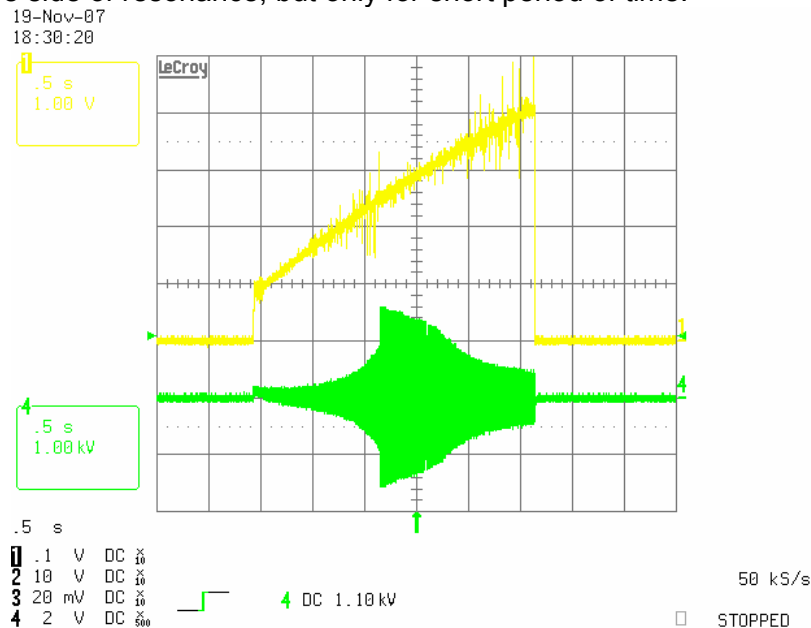

Figure 10.1: Lamp non-strike: CH1 is the VCO voltage, CH4 is the voltage across lamp

AC Mains Interrupt / Brown-Out Conditions

This protection relies on the non-ZVS circuit of IRS2530D, enabled in the Dim Mode. During an AC mains interrupt or brown-out condition, the DC bus can decrease and cause the system to operate too close to, or, on the capacitive side of resonance. The result is non-ZVS switching that causes high peak currents to flow in the half-bridge MOSFETs that can damage or destroy them.

To protect against this, the IRS2530D will detect non-ZVS by measuring the VS voltage at each rising edge of LO. If the voltage is greater than VZVSTH (4.5V, typical), the IC will reduce the voltage at VCO pin, and thus increase the frequency until ZVS is reached again (Figure 10.2).

In case the DC bus decreases too far and the lamp extinguishes, the VCC voltage will go below VCCUV- (10.5V, typical) and the ignition/preheat ramp will be reset to re-ignite the lamp reliably.

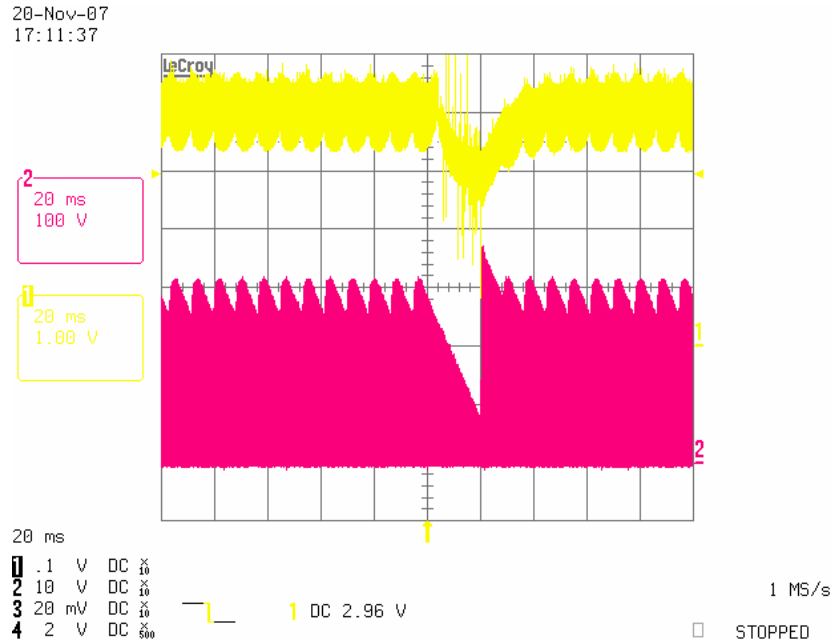

Figure 10.2: Brown-out conditions: CH1 is the VCO voltage, CH2 is the VS voltage

Lamp Removal

When the lamp is removed, the IRS2530D uses the Crest Factor Over-current Protection to enter the Fault mode and shut down. During lamp removal, the output stage will transition to a series-LC configuration, and the frequency will move towards resonance until the inductor saturates. The IRS2530D uses the VS-sensing circuitry and the R_{DSon} of the low-side half-bridge MOSFET to measure the MOSFET current for detecting an over-current fault. Should the peak current exceed the average current by a factor of 5.5 ($CF > 5.5$) during the on-time of LO, the IRS2530D will enter Fault Mode, where the half-bridge is off. Performing crest factor measurement provides a relative current measurement that cancels temperature and/or tolerance variations of the R_{DSon} of the low-side half-bridge MOSFET.

Figure 10.3 shows the voltage across the lamp and the VS voltage when the lower filament of the lamp is removed. Figure 10.4 shows these voltages when the upper filament of the lamp is removed. In both cases, the IRS2530D will enter the Fault Mode and shut down after detecting that the crest factor exceeds 5 during the on-time of LO. Figure 10.5 shows the VS pin, inductor current, and voltage across lamp when the inductor saturates and the ballast shuts down.

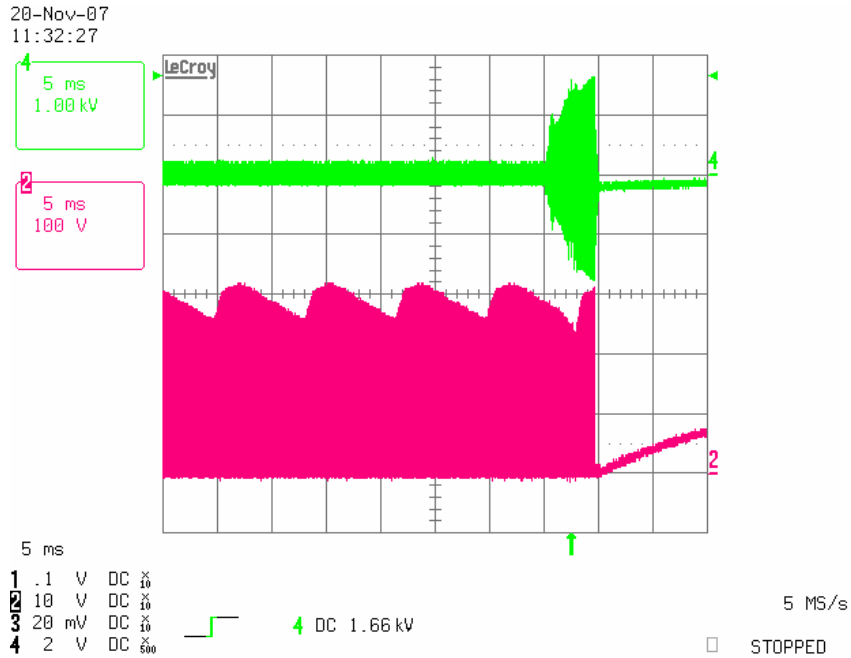

Figure 10.3: Lower filament removed: CH2 is the VS voltage, CH4 is the voltage across the lamp

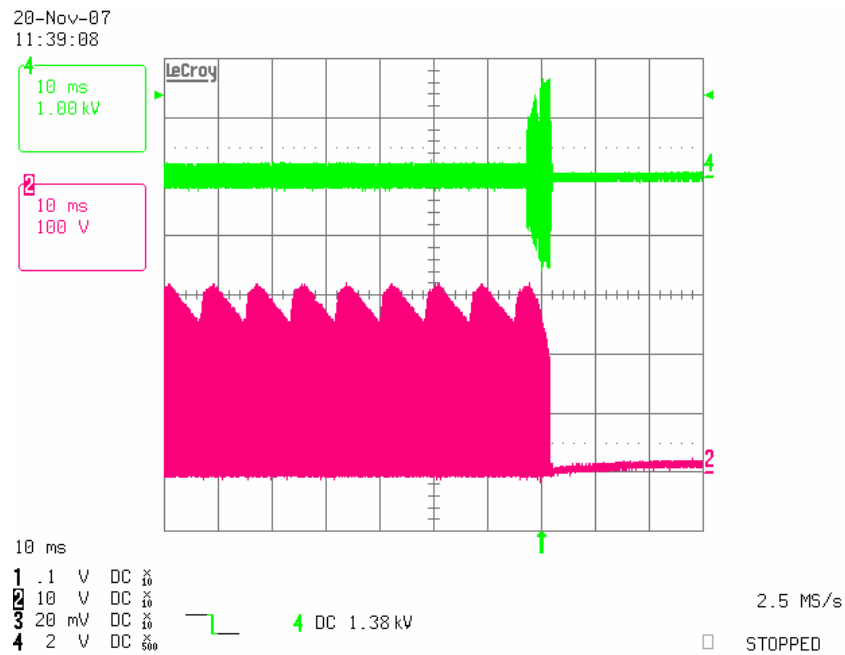

Figure 10.4: Upper filament removed: CH2 is the VS voltage, CH4 is the voltage across the lamp

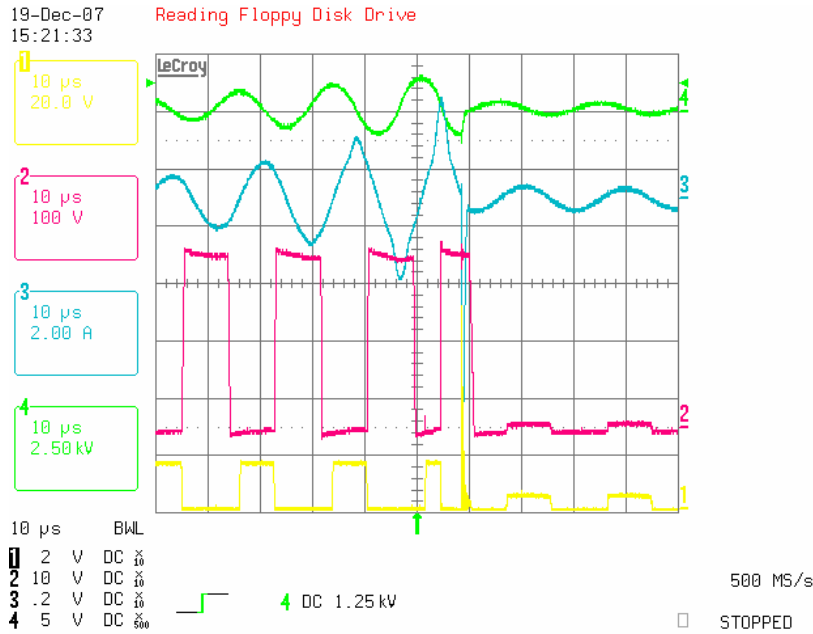

Figure 10.5: Inductor saturation: CH1 is the LO voltage, CH2 is the VS voltage, CH3 is the current through the resonant inductor, and CH4 is the voltage across the lamp

Figure 10.6 shows the VS voltage and the voltage across the lamp when the IC undergoes reset with a lamp exchange. When the lamp is removed, crest factor protection is triggered, and the IC enters the Fault mode and shuts down. Since the lamp is removed, LO pins is pulled above VLOSD+, and the IC goes to UVLO mode. When the lamp is re-inserted, the IC goes back to the Preheat / Ignition mode, and the half-bridge starts to oscillate again.

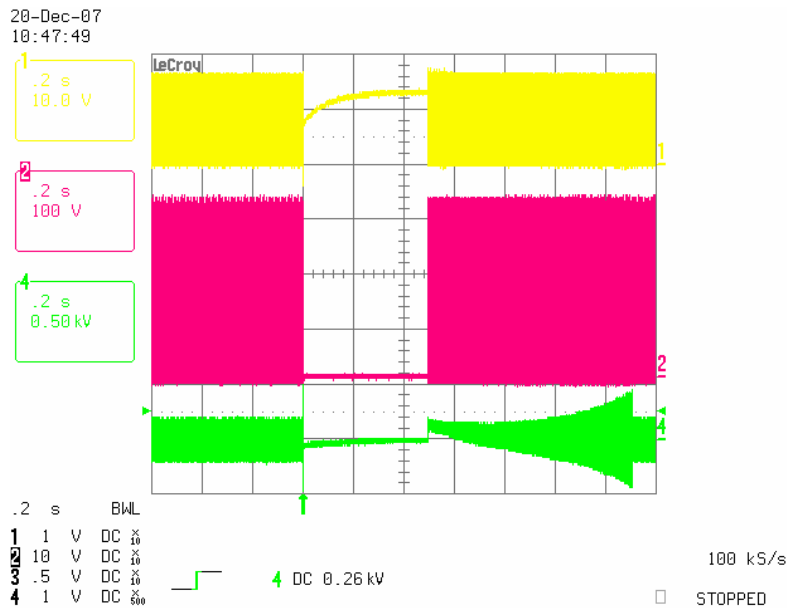
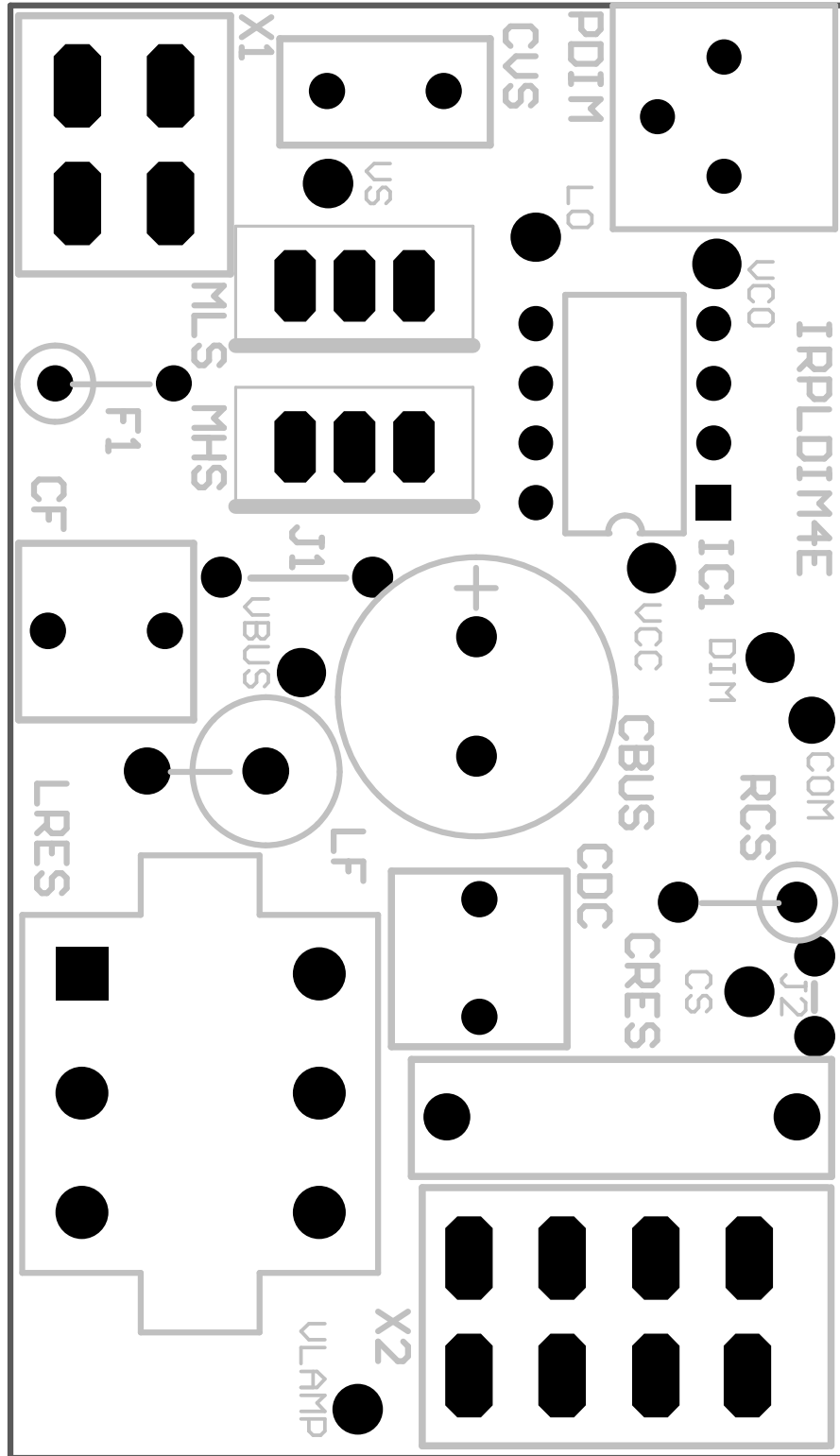
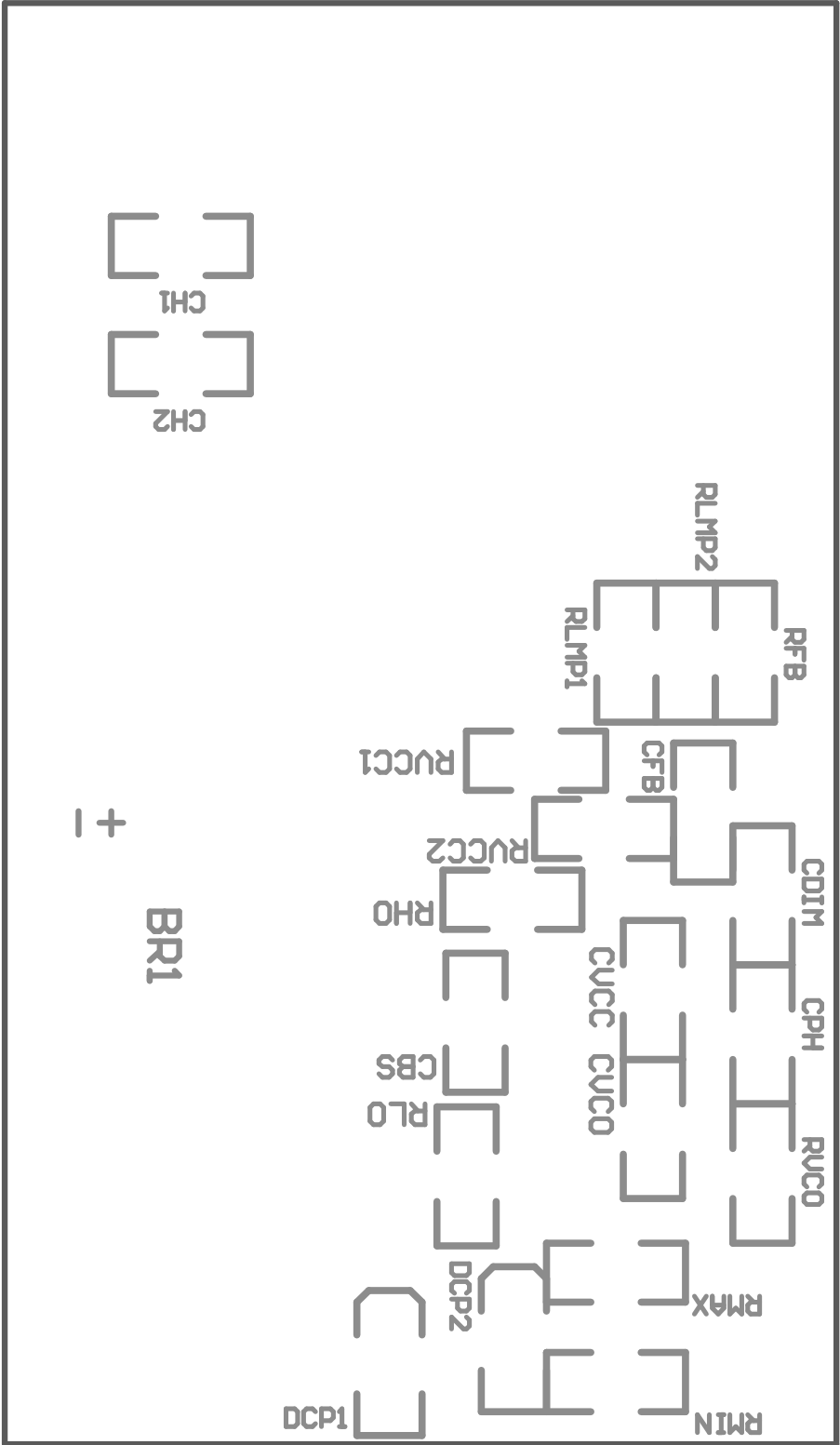

Figure 10.6: Lamp exchange: CH1 is the LO voltage, CH2 is the VS voltage, and CH4 is the voltage across the lamp

11. PCB Layout and Component Placement

Top Silk Screen Layer





Bottom Silk Screen Layer

Bottom Copper Layer

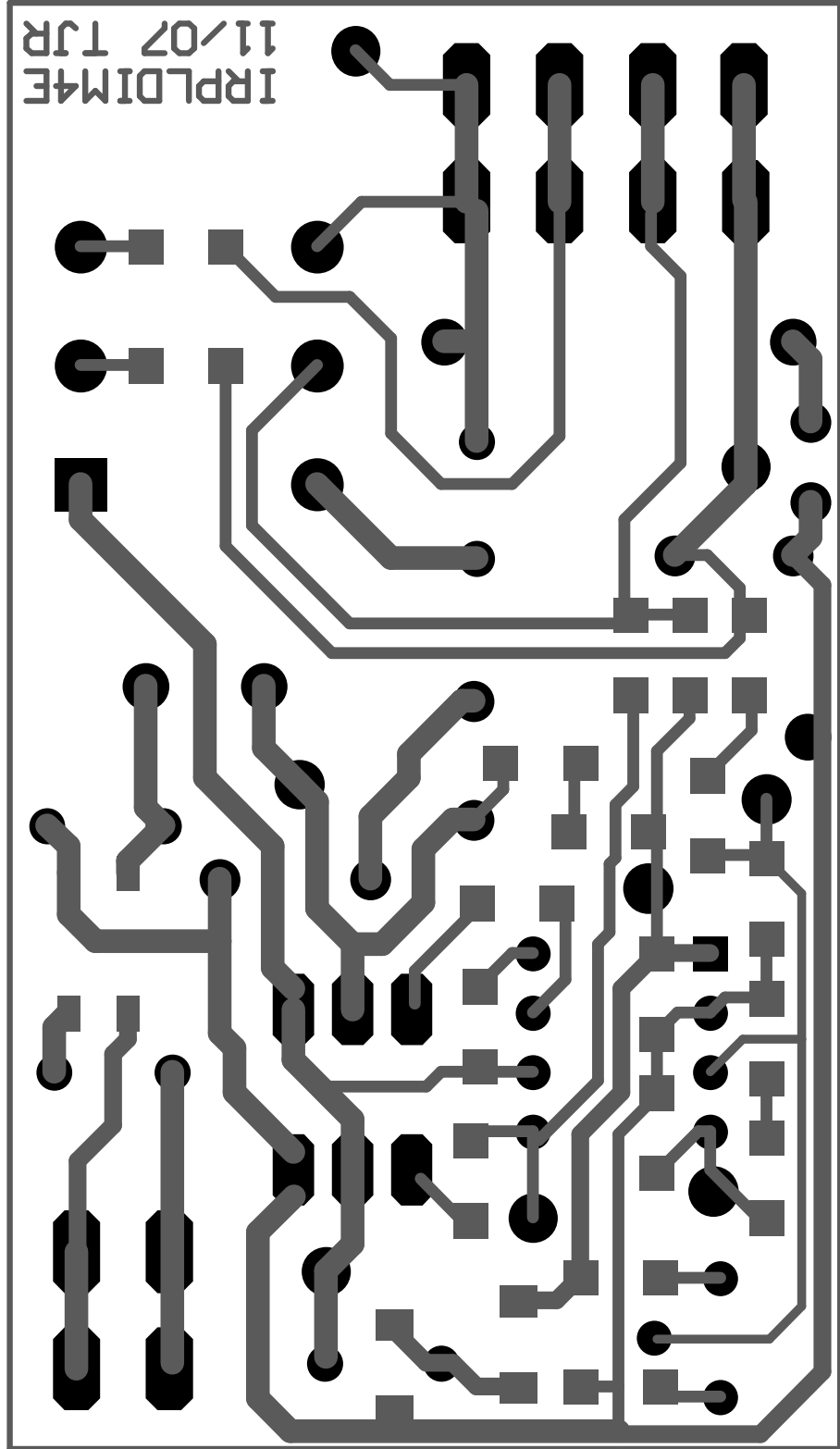

12. Inductor Specifications

Vogt # IL 070 503 11 02
BI Technologies # HM00-07544



INDUCTOR SPECIFICATION

CORE SIZE

GAP LENGTH mm

CORE MATERIAL

NOMINAL INDUCTANCE mH

TEST TEMPERATURE C

WINDING	START PIN	FINISH PIN	TURNS	WIRE DIAMETER (mm)
MAIN	1	6	240*	10/ 38 Multistranded
CATHODE	2	5	5.5	26 awg insulated
CATHODE	3	4	5.5	26 awg insulated

PHYSICAL LAYOUT
(Vertical6- Pin Bobbin)

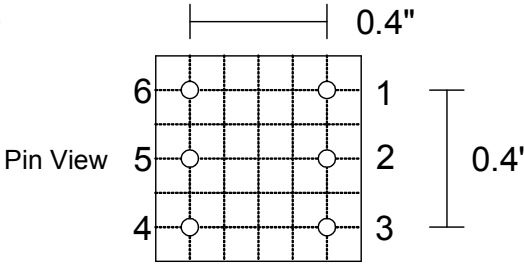

TEST TEST TEMPERATURE C

MAIN WINDING INDUCTANCE mH

* Adjust turns for specified Inductance mH

Mouser Electronics

Authorized Distributor

Click to View Pricing, Inventory, Delivery & Lifecycle Information:

[Infineon:](#)

[IRPLDIM4E](#)

Компания «Океан Электроники» предлагает заключение долгосрочных отношений при поставках импортных электронных компонентов на взаимовыгодных условиях!

Наши преимущества:

- Поставка оригинальных импортных электронных компонентов напрямую с производств Америки, Европы и Азии, а так же с крупнейших складов мира;
- Широкая линейка поставок активных и пассивных импортных электронных компонентов (более 30 млн. наименований);
- Поставка сложных, дефицитных, либо снятых с производства позиций;
- Оперативные сроки поставки под заказ (от 5 рабочих дней);
- Экспресс доставка в любую точку России;
- Помощь Конструкторского Отдела и консультации квалифицированных инженеров;
- Техническая поддержка проекта, помощь в подборе аналогов, поставка прототипов;
- Поставка электронных компонентов под контролем ВП;
- Система менеджмента качества сертифицирована по Международному стандарту ISO 9001;
- При необходимости вся продукция военного и аэрокосмического назначения проходит испытания и сертификацию в лаборатории (по согласованию с заказчиком);
- Поставка специализированных компонентов военного и аэрокосмического уровня качества (Xilinx, Altera, Analog Devices, Intersil, Interpoint, Microsemi, Actel, Aeroflex, Peregrine, VPT, Syfer, Eurofarad, Texas Instruments, MS Kennedy, Miteq, Cobham, E2V, MA-COM, Hittite, Mini-Circuits, General Dynamics и др.);

Компания «Океан Электроники» является официальным дистрибьютором и эксклюзивным представителем в России одного из крупнейших производителей разъемов военного и аэрокосмического назначения «JONHON», а так же официальным дистрибьютором и эксклюзивным представителем в России производителя высокотехнологичных и надежных решений для передачи СВЧ сигналов «FORSTAR».



JONHON

«JONHON» (основан в 1970 г.)

Разъемы специального, военного и аэрокосмического назначения:

(Применяются в военной, авиационной, аэрокосмической, морской, железнодорожной, горно- и нефтедобывающей отраслях промышленности)

«FORSTAR» (основан в 1998 г.)

ВЧ соединители, коаксиальные кабели, кабельные сборки и микроволновые компоненты:

(Применяются в телекоммуникациях гражданского и специального назначения, в средствах связи, РЛС, а так же военной, авиационной и аэрокосмической отраслях промышленности).



Телефон: 8 (812) 309-75-97 (многоканальный)

Факс: 8 (812) 320-03-32

Электронная почта: ocean@oceanchips.ru

Web: <http://oceanchips.ru/>

Адрес: 198099, г. Санкт-Петербург, ул. Калинина, д. 2, корп. 4, лит. А