

# CONTROL KNOBS, MACHINED ALUMINUM

## FEATURES

- Anodized natural or black gloss finish.
- Anti-static plastic insert. (on many models)
- Positive retention #6-32 set screws.
- Fits 1/8" dia. & 1/4" dia. shafts.
- Functionally rugged.
- Special designs available.

## MATERIALS

Knob:  
Threaded Insert:  
Setscrew:

Machined aluminium (with plastic insert, where indicated).  
Brass.  
Heat treated high alloy steel with cup point and hex head,  
or slotted head. Note: 1 or 2 supplied, depending on model.

Notes: Dims. in inches & (millimeters). Shaft size is last 3 digits of Model No.

### 41005 SERIES Smooth finish with knurled black plastic insert and black indicator line on top



Note: Knob color is natural only for this Series.

MODEL (Color natural)	A	B	C
410051A1/8	.630 (16.0)	.512 (13.0)	.590 (15.0)
410051A1/4	.630 (16.0)	.512 (13.0)	.590 (15.0)
410053A1/8	.874 (22.2)	.472 (12.0)	.531 (13.5)
410053A1/4	.874 (22.2)	.646 (16.4)	.690 (17.5)
410055A1/4	1.260 (32.0)	.472 (12.0)	.551 (14.0)

### 42001 SERIES Fluted with plastic insert and line indicator on side



MODEL (Color-natural)	MODEL (Color-black)	A	B	C	D	E	F	G
420011A1/8*	420011B1/8*	.500 (12.7)	.430 (10.9)	.380 (9.7)	.430 (10.9)	.630 (16.0)	.512 (13.0)	.430 (10.9)
420011A1/4*	420011B1/4*	.500 (12.7)	.430 (10.9)	.380 (9.7)	.430 (10.9)	.630 (16.0)	.512 (13.0)	.430 (10.9)
420013A1/4	420013B1/4	.748 (19.0)	.638 (16.2)	.591 (15.0)	.661 (16.8)	.630 (16.0)	.512 (13.0)	.429 (10.9)
420015A1/4	420015B1/4	.941 (23.9)	.819 (20.8)	.709 (18.0)	.819 (20.8)	.630 (16.0)	.512 (13.0)	.429 (10.9)

\* indicates solid aluminum knob

### 42003 SERIES Diamond knurl plastic insert and line indicator on side



Note: 420031A1/8 & 420031A1/4 have only one set screw.

MODEL (Color-natural)	MODEL (Color-black)	A	B	C	D	E	F	G
420031A1/8*	420031B1/8*	.500 (12.7)	.402 (10.2)	.380 (9.7)	.402 (10.2)	.634 (16.1)	.516 (13.1)	.469 (11.9)
420031A1/4*	420031B1/4*	.500 (12.7)	.402 (10.2)	.380 (9.7)	.402 (10.2)	.634 (16.1)	.516 (13.1)	.469 (11.9)
420033A1/4*	420033B1/4*	.748 (19.0)	.681 (17.3)	.591 (15.0)	.681 (17.3)	.634 (16.1)	.516 (13.1)	.469 (11.9)
420035A1/4*	420035B1/4*	.940 (23.9)	.870 (22.1)	.709 (18.0)	.870 (22.1)	.634 (16.1)	.516 (13.1)	.469 (11.9)
420037A1/4*	420037B1/4*	1.252 (31.8)	1.170 (29.6)	.980 (24.9)	1.170 (29.6)	.748 (19.0)	.630 (16.0)	.591 (15.0)

\* indicates solid aluminum knob

SPECIFICATIONS SUBJECT TO CHANGE WITHOUT NOTICE.

Notes: Dims. in inches & (millimeters). Shaft size is last 3 digits of Model No.

**42004 SERIES** Straight knurl with plastic insert and line indicator on top

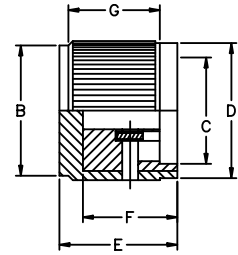
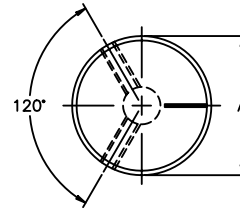

Note: 420041A1/8 & 420041A1/4 have only one set screw.

MODEL (Color-natural)	MODEL (Color-black)	A	B	C	D	E	F	G
420041A1/8*	420041B1/8*	.500 (12.7)	.480 (12.2)	.378 (9.6)	.480 (12.2)	.788 (20)	.520 (13.2)	.453 (11.5)
420041A1/4*	420041B1/4*	.500 (12.7)	.480 (12.2)	.378 (9.6)	.480 (12.2)	.788 (20)	.520 (13.2)	.453 (11.5)
420043A1/4	420043B1/4	.748 (19.0)	.728 (18.5)	.524 (13.3)	.728 (18.5)	.788 (20)	.520 (13.2)	.453 (11.5)
420045A1/4	420045B1/4	.929 (23.6)	.870 (22.1)	.720 (18.3)	.870 (22.1)	.788 (20)	.520 (13.2)	.453 (11.5)

\* indicates solid aluminum knob

**42005 SERIES** Solid aluminum with straight knurl and arrowhead indicator on top

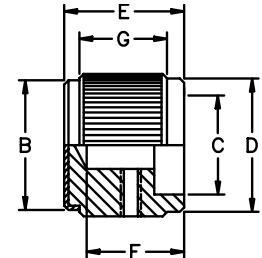
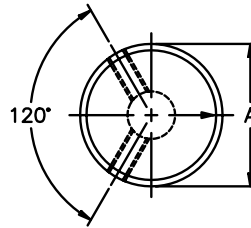

Note: 420051A1/8 & 420051A1/4 have only one set screw.

MODEL (Color-natural)	MODEL (Color-black)	A	B	C	D	E	F	G
420051A1/8*	420051B1/8*	.500 (12.7)	.480 (12.2)	.378 (9.6)	.480 (12.2)	.638 (16.2)	.520 (13.2)	.453 (11.5)
420051A1/4*	420051B1/4*	.500 (12.7)	.480 (12.2)	.378 (9.6)	.480 (12.2)	.638 (16.2)	.520 (13.2)	.453 (11.5)
420053A1/4	420053B1/4	.748 (19.0)	.728 (18.5)	.524 (13.3)	.728 (18.5)	.638 (16.2)	.520 (13.2)	.453 (11.5)
420055A1/4	420055B1/4	.929 (23.6)	.870 (23.2)	.720 (18.3)	.870 (23.2)	.638 (16.2)	.520 (13.2)	.453 (11.5)

\* indicates solid aluminum knob

**42006 SERIES** Straight knurl with plastic insert and line indicator on top and side

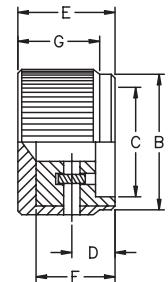

Note: 420061A1/8 & 420061A1/4 have only one set screw.

MODEL (Color-natural)	MODEL (Color-black)	A	B	C	D	E	F	G
420061A1/8*	420061B1/8*	.500 (12.7)	.480 (12.2)	.378 (9.6)	.280 (7.1)	.638 (16.2)	.520 (13.2)	.524 (13.3)
420061A1/4*	420061B1/4*	.500 (12.7)	.480 (12.2)	.378 (9.6)	.280 (7.1)	.638 (16.2)	.520 (13.2)	.524 (13.3)
420063A1/4	420063B1/4	.748 (19.0)	.728 (18.5)	.524 (13.3)	.280 (7.1)	.638 (16.2)	.520 (13.2)	.524 (13.3)
420065A1/4	420065B1/4	.940 (23.9)	.870 (23.2)	.720 (18.3)	.280 (7.1)	.638 (16.2)	.520 (13.2)	.524 (13.3)
420067A1/4	420067B1/4	1.248 (31.7)	1.220 (31.0)	1.030 (26.2)	.280 (7.1)	.638 (16.2)	.512 (13.0)	.531 (13.5)

\* indicates solid aluminum knob

**42007 SERIES** Serrated diamond trim with plastic insert and dot indicator on top

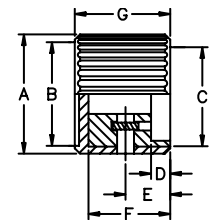
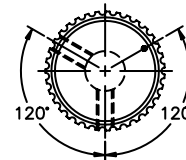

Note: 420071A1/8 & 420072A1/8 have only one set screw.

\* indicates solid aluminum knob

MODEL (Color-natural)	MODEL (Color-black)	A	B	C	D	E	F	G
420071A1/8*	420071B1/8*	.370 (9.4)	.268 (6.8)	.276 (7.0)	.091 (2.3)	.200 (5.1)	.240 (6.1)	.300 (7.6)
420072A1/8*	420072B1/8*	.370 (9.4)	.268 (6.8)	.276 (7.0)	.091 (2.3)	.200 (5.1)	.358 (9.1)	.449 (11.4)
420072A1/4*	420072B1/4*	.370 (9.4)	.268 (6.8)	.276 (7.0)	.091 (2.3)	.200 (5.1)	.358 (9.1)	.449 (11.4)
420073A1/8*	420073B1/8*	.492 (12.5)	.386 (9.8)	.380 (9.7)	.120 (3.1)	.280 (7.1)	.512 (13.0)	.598 (15.2)
420073A1/4*	420073B1/4*	.492 (12.5)	.386 (9.8)	.380 (9.7)	.120 (3.1)	.280 (7.1)	.512 (13.0)	.598 (15.2)
420074A1/4	420074B1/4	.748 (19.0)	.650 (16.5)	.587 (14.9)	.120 (3.1)	.280 (7.1)	.512 (13.0)	.598 (15.2)

\* indicates solid aluminum knob

SPECIFICATIONS SUBJECT TO CHANGE WITHOUT NOTICE.

Notes: Dims. in inches & (millimeters). Shaft size is last 3 digits of Model No.

**42008 SERIES** Square serrations with plastic insert and line indicator on side



Note: 420081A1/8 & 420081A1/4 have only one set screw.

MODEL (Color-natural)	MODEL (Color-black)	A	B	C	D	E	F	G
420081A1/8*	420081B1/8*	.500 (12.7)	.402 (10.2)	.380 (9.7)	.402 (10.2)	.280 (7.1)	.512 (13.0)	.630 (16.0)
420081A1/4*	420081B1/4*	.500 (12.7)	.402 (10.2)	.380 (9.7)	.402 (10.2)	.280 (7.1)	.512 (13.0)	.630 (16.0)
420083A1/4	420083B1/4	.748 (19.0)	.681 (17.3)	.587 (14.9)	.681 (17.3)	.280 (7.1)	.512 (13.0)	.630 (16.0)
420085A1/4	420085B1/4	.940 (23.9)	.870 (22.1)	.709 (18.0)	.870 (22.1)	.280 (7.1)	.512 (13.0)	.630 (16.0)
420087A1/4	420087B1/4	1.248 (31.7)	1.165 (29.6)	.985 (25)	1.165 (29.6)	.280 (7.1)	.630 (16.0)	.630 (16.0)

\* indicates solid aluminum knob

**42009 SERIES** Straight knurl with plastic insert and line indicator on top and chamfer around top



Note: Knob color is black only for this Series.

MODEL (Color black)	A	B	C
420091B1/8	.732 (18.6)	.374 (9.5)	.472 (12.0)
420091B1/4	.732 (18.6)	.374 (9.5)	.472 (12.0)
420092B1/4	.898 (22.8)	.433 (11.0)	.512 (13.0)
420093B1/4	1.280 (32.5)	.492 (12.5)	.551 (14.0)
420094B1/4	1.512 (38.4)	.531 (13.5)	.630 (16.0)

\* indicates solid aluminum knob

**42011 SERIES** Smooth finish with plastic insert and line indicator on top



MODEL (Color-natural)	MODEL (Color-black)	A	B	C
420111A1/8	420111B1/8	.709 (18.0)	.374 (9.5)	.472 (12.0)
420111A1/4	420111B1/4	.709 (18.0)	.374 (9.5)	.472 (12.0)
420112A1/4	420112B1/4	.874 (22.2)	.433 (11.0)	.512 (13.0)
420113A1/4	420113B1/4	1.255 (31.9)	.492 (12.5)	.551 (14.0)
420114A1/4	420114B1/4	1.488 (37.8)	.531 (13.5)	.630 (16.0)

\* indicates solid aluminum knob

**42012 SERIES** Straight knurl with plastic insert and line indicator on top



MODEL (Color-natural)	A	B	C
420121A1/8	.732 (18.6)	.374 (9.5)	.472 (12.0)
420121A1/4	.732 (18.6)	.374 (9.5)	.472 (12.0)
420122A1/4	.898 (22.8)	.433 (11.0)	.512 (13.0)
420123A1/4	1.280 (32.5)	.492 (12.5)	.551 (14.0)
420124A1/4	1.512 (38.4)	.531 (13.5)	.630 (16.0)

\* indicates solid aluminum knob

SPECIFICATIONS SUBJECT TO CHANGE WITHOUT NOTICE.



Notes: Dims. in inches & (millimeters). Shaft size is last 3 digits of Model No.

**KB SERIES** Solid aluminum with straight knurl and line indicator on top



MODEL	COLOR	A	B	C	D	E	F	G
KB500A1/8AL	Natural	.500 (12.7)	.430 (10.9)	.390 (9.90)	.470 (11.9)	.790 (20.0)	.630 (16.0)	.610 (15.5)
KB500A1/4AL	Natural	.500 (12.7)	.430 (10.9)	.390 (9.90)	.470 (11.9)	.790 (20.0)	.630 (16.0)	.610 (15.5)
KB500B1/8AL	Black	.500 (12.7)	.430 (10.9)	.390 (9.90)	.470 (11.9)	.790 (20.0)	.630 (16.0)	.610 (15.5)
KB500B1/4AL	Black	.500 (12.7)	.430 (10.9)	.390 (9.90)	.470 (11.9)	.790 (20.0)	.630 (16.0)	.610 (15.5)
KB700A1/4AL	Natural	.750 (19.0)	.680 (17.3)	.590 (15.0)	.710 (18.0)	.790 (20.0)	.630 (16.0)	.610 (15.5)
KB700B1/4AL	Black	.750 (19.0)	.680 (17.3)	.590 (15.0)	.710 (18.0)	.790 (20.0)	.630 (16.0)	.610 (15.5)
KB900A1/4AL	Natural	.930 (23.6)	.870 (22.1)	.710 (18.0)	.900 (22.9)	.790 (20.0)	.630 (16.0)	.610 (15.5)
KB900B1/4AL	Black	.930 (23.6)	.870 (22.1)	.710 (18.0)	.900 (22.9)	.790 (20.0)	.630 (16.0)	.610 (15.5)
<b>TWO-TONED BODY-TOP</b>								
KB500AB1/8AL	NTL. & BLK.	.500 (12.7)	.430 (10.9)	.390 (9.90)	.470 (11.9)	.790 (20.0)	.630 (16.0)	.610 (15.5)
KB500AB1/4AL	NTL. & BLK.	.500 (12.7)	.430 (10.9)	.390 (9.90)	.470 (11.9)	.790 (20.0)	.630 (16.0)	.610 (15.5)
KB500BA1/8AL	BLK. & NTL.	.500 (12.7)	.430 (10.9)	.390 (9.90)	.470 (11.9)	.790 (20.0)	.630 (16.0)	.610 (15.5)
KB500BA1/4AL	BLK. & NTL.	.500 (12.7)	.430 (10.9)	.390 (9.90)	.470 (11.9)	.790 (20.0)	.630 (16.0)	.610 (15.5)
KB700AB1/4AL	NTL. & BLK.	.750 (19.0)	.680 (17.3)	.590 (15.0)	.710 (18.0)	.790 (20.0)	.630 (16.0)	.610 (15.5)
KB700BA1/4AL	BLK. & NTL.	.750 (19.0)	.680 (17.3)	.590 (15.0)	.710 (18.0)	.790 (20.0)	.630 (16.0)	.610 (15.5)
KB900AB1/4AL	NTL. & BLK.	.930 (23.6)	.870 (22.1)	.710 (18.0)	.900 (22.9)	.790 (20.0)	.630 (16.0)	.610 (15.5)
KB900BA1/4AL	BLK. & NTL.	.930 (23.6)	.870 (22.1)	.710 (18.0)	.900 (22.9)	.790 (20.0)	.630 (16.0)	.610 (15.5)

**KHF SERIES** Solid aluminum with smooth finish and sawcut indicator on top and side

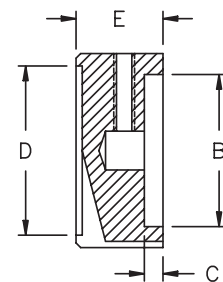
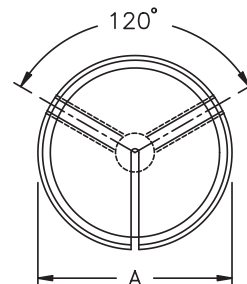

MODEL (Color-natural)	A	B	C	D	E
KHF500A1/4	.500 (12.7)	.380 (9.65)	.120 (3.05)	.340 (8.64)	.560 (14.2)
KHF700A1/4	.750 (19.0)	.590 (14.90)	.120 (3.05)	.580 (14.7)	.560 (14.2)
KHF900A1/4	.940 (23.9)	.710 (18.0)	.120 (3.05)	.780 (19.8)	.560 (14.2)
KHF1250A1/4	1.25 (31.8)	.980 (24.9)	.120 (3.05)	1.09 (27.7)	.560 (14.2)

**KN SERIES** Solid aluminum with straight knurl and arrowhead indicator on top

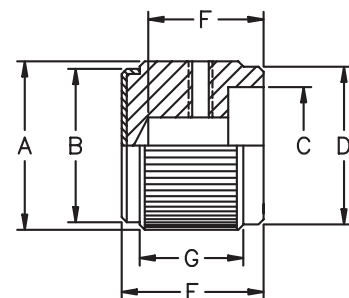

MODEL (Two-toned)	COLOR (Body-top)	A	B	C	D	E	F	G
KN501BA1/8	Blk. & Natural	.500 (12.7)	.450 (11.4)	.380 (9.65)	.450 (11.4)	.630 (16.0)	.510 (13.0)	.460 (11.7)
KN501BA1/4	Blk. & Natural	.500 (12.7)	.450 (11.4)	.380 (9.65)	.450 (11.4)	.630 (16.0)	.510 (13.0)	.460 (11.7)
KN701BA1/8	Blk. & Natural	.750 (19.0)	.680 (17.3)	.590 (15.0)	.700 (17.8)	.630 (16.0)	.510 (13.0)	.460 (11.7)
KN701BA1/4	Blk. & Natural	.750 (19.0)	.680 (17.3)	.590 (15.0)	.700 (17.8)	.630 (16.0)	.510 (13.0)	.460 (11.7)

SPECIFICATIONS SUBJECT TO CHANGE WITHOUT NOTICE.

Notes: Dims. in inches & (millimeters). Shaft size is last 3 digits of Model No.

**KN SERIES** Solid aluminum with straight knurl and line indicator on side

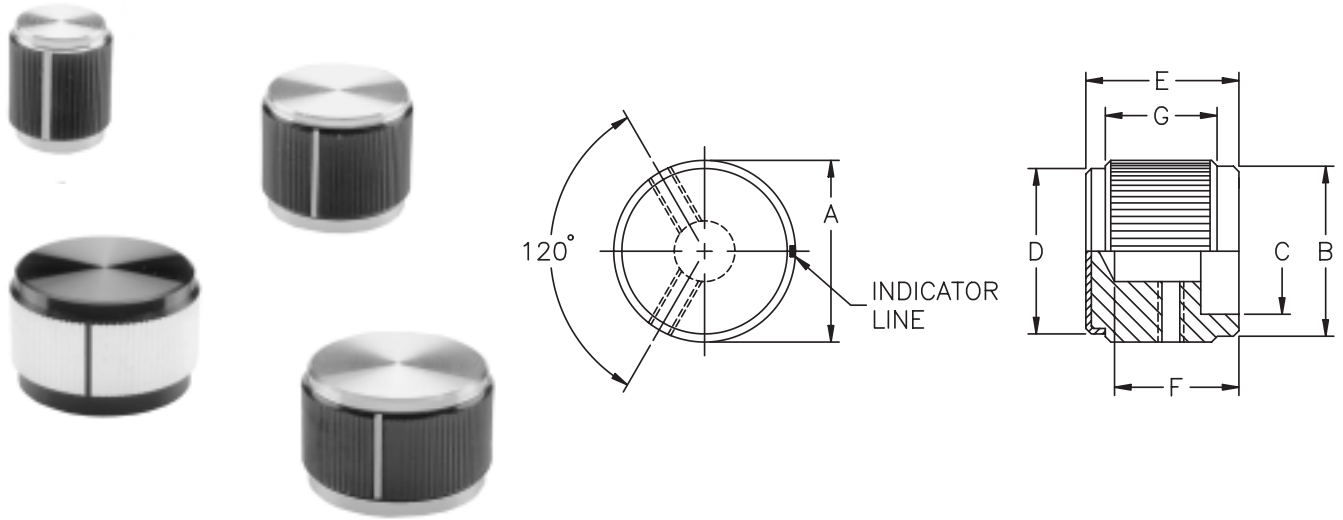

SPECIFICATIONS SUBJECT TO CHANGE WITHOUT NOTICE.

MODEL (Two-toned)	COLOR (Body-top)	A	B	C	D	E	F	G
KN500AB1/8	Natural & Blk.	.500 (12.7)	.450 (11.4)	.380 (9.65)	.450 (11.4)	.630 (16.0)	.510 (13.0)	.460 (11.7)
KN500AB1/4	Natural & Blk.	.500 (12.7)	.450 (11.4)	.380 (9.65)	.450 (11.4)	.630 (16.0)	.510 (13.0)	.460 (11.7)
KN500BA1/8	Blk. & Natural	.500 (12.7)	.450 (11.4)	.380 (9.65)	.450 (11.4)	.630 (16.0)	.510 (13.0)	.460 (11.7)
KN500BA1/4	Blk. & Natural	.500 (12.7)	.450 (11.4)	.380 (9.65)	.450 (11.4)	.630 (16.0)	.510 (13.0)	.460 (11.7)
KN700AB1/4	Natural & Blk.	.750 (19.0)	.700 (17.8)	.590 (14.9)	.700 (17.8)	.630 (16.0)	.510 (13.0)	.460 (11.7)
KN700BA1/4	Blk. & Natural	.750 (19.0)	.700 (17.8)	.590 (14.9)	.700 (17.8)	.630 (16.0)	.510 (13.0)	.460 (11.7)
KN900AB1/4	Natural & Blk.	.940 (23.9)	.880 (22.3)	.710 (18.0)	.800 (22.3)	.630 (16.0)	.510 (13.0)	.460 (11.7)
KN900BA1/4	Blk. & Natural	.940 (23.9)	.880 (22.3)	.710 (18.0)	.800 (22.3)	.630 (16.0)	.510 (13.0)	.460 (11.7)
KN1250AB1/4	Natural & Blk.	1.25 (31.7)	1.20 (30.5)	.980 (24.9)	1.20 (30.5)	.630 (16.0)	.510 (13.0)	.460 (11.7)
KN1250BA1/4	Blk. & Natural	1.25 (31.7)	1.20 (30.5)	.980 (24.9)	1.20 (30.5)	.630 (16.0)	.510 (13.0)	.460 (11.7)

**KNS SERIES** Solid aluminum with straight knurl and arrowhead indicator on skirt



MODEL	COLOR	A	B	C	D	E	F	G
KNS501A1/8	Natural	.500 (12.7)	.450 (11.4)	.380 (9.65)	.750 (19.0)	.630 (16.0)	.510 (13.0)	.430 (10.9)
KNS501A1/4	Natural	.500 (12.7)	.450 (11.4)	.380 (9.65)	.750 (19.0)	.630 (16.0)	.510 (13.0)	.430 (10.9)
KNS501B1/8	Black	.500 (12.7)	.450 (11.4)	.380 (9.65)	.750 (19.0)	.630 (16.0)	.510 (13.0)	.430 (10.9)
KNS501B1/4	Black	.500 (12.7)	.450 (11.4)	.380 (9.65)	.750 (19.0)	.630 (16.0)	.510 (13.0)	.430 (10.9)
KNS701A1/4	Natural	.750 (19.0)	.700 (17.8)	.590 (14.9)	1.13 (28.3)	.630 (16.0)	.510 (13.0)	.430 (10.9)
KNS701B1/4	Black	.750 (19.0)	.700 (17.8)	.590 (14.9)	1.13 (28.3)	.630 (16.0)	.510 (13.0)	.430 (10.9)
<b>TWO-TONED</b>	<b>BODY-TOP-SKIRT</b>							
KNS501BA1/8	Blk. & Natural	.500 (12.7)	.450 (11.4)	.380 (9.65)	.750 (19.0)	.630 (16.0)	.510 (13.0)	.430 (10.9)
KNS501BA1/4	Blk. & Natural	.500 (12.7)	.450 (11.4)	.380 (9.65)	.750 (19.0)	.630 (16.0)	.510 (13.0)	.430 (10.9)
KNS701BA1/8	Blk. & Natural	.750 (19.0)	.700 (17.8)	.590 (14.9)	1.13 (28.3)	.630 (16.0)	.510 (13.0)	.430 (10.9)
KNS701BA1/4	Blk. & Natural	.750 (19.0)	.700 (17.8)	.590 (14.9)	1.13 (28.3)	.630 (16.0)	.510 (13.0)	.430 (10.9)



Notes: Dims. in inches & (millimeters). Shaft size is last 3 digits of Model No.

**KS SERIES** Solid aluminum with 3 flute design and line indicator on side and skirt



MODEL	COLOR	A	B	C	D	E	F	G
KS500A1/8	Natural	.500 (12.7)	.430 (10.9)	.380 (9.65)	.750 (19.0)	.630 (16.0)	.510 (12.9)	.430 (10.9)
KS500A1/4	Natural	.500 (12.7)	.430 (10.9)	.380 (9.65)	.750 (19.0)	.630 (16.0)	.510 (12.9)	.430 (10.9)
KS500B1/8	Black	.500 (12.7)	.430 (10.9)	.380 (9.65)	.750 (19.0)	.630 (16.0)	.510 (12.9)	.430 (10.9)
KS500B1/4	Black	.500 (12.7)	.430 (10.9)	.380 (9.65)	.750 (19.0)	.630 (16.0)	.510 (12.9)	.430 (10.9)
KS700A1/4	Natural	.750 (19.0)	.650 (16.5)	.590 (14.9)	1.12 (28.4)	.630 (16.0)	.510 (12.9)	.430 (10.9)
KS700B1/4	Black	.750 (19.0)	.650 (16.5)	.590 (14.9)	1.12 (28.4)	.630 (16.0)	.510 (12.9)	.430 (10.9)
KS900A1/4	Natural	.940 (23.9)	.820 (20.8)	.710 (18.0)	1.40 (35.6)	.630 (16.0)	.510 (12.9)	.430 (10.9)
KS900B1/4	Black	.940 (23.9)	.820 (20.8)	.710 (18.0)	1.40 (35.6)	.630 (16.0)	.510 (12.9)	.430 (10.9)

SPECIFICATIONS SUBJECT TO CHANGE WITHOUT NOTICE.



Компания «Океан Электроники» предлагает заключение долгосрочных отношений при поставках импортных электронных компонентов на взаимовыгодных условиях!

Наши преимущества:

- Поставка оригинальных импортных электронных компонентов напрямую с производств Америки, Европы и Азии, а так же с крупнейших складов мира;
- Широкая линейка поставок активных и пассивных импортных электронных компонентов (более 30 млн. наименований);
- Поставка сложных, дефицитных, либо снятых с производства позиций;
- Оперативные сроки поставки под заказ (от 5 рабочих дней);
- Экспресс доставка в любую точку России;
- Помощь Конструкторского Отдела и консультации квалифицированных инженеров;
- Техническая поддержка проекта, помощь в подборе аналогов, поставка прототипов;
- Поставка электронных компонентов под контролем ВП;
- Система менеджмента качества сертифицирована по Международному стандарту ISO 9001;
- При необходимости вся продукция военного и аэрокосмического назначения проходит испытания и сертификацию в лаборатории (по согласованию с заказчиком);
- Поставка специализированных компонентов военного и аэрокосмического уровня качества (Xilinx, Altera, Analog Devices, Intersil, Interpoint, Microsemi, Actel, Aeroflex, Peregrine, VPT, Syfer, Eurofarad, Texas Instruments, MS Kennedy, Miteq, Cobham, E2V, MA-COM, Hittite, Mini-Circuits, General Dynamics и др.);

Компания «Океан Электроники» является официальным дистрибьютором и эксклюзивным представителем в России одного из крупнейших производителей разъемов военного и аэрокосмического назначения «JONHON», а так же официальным дистрибьютором и эксклюзивным представителем в России производителя высокотехнологичных и надежных решений для передачи СВЧ сигналов «FORSTAR».



## JONHON

«JONHON» (основан в 1970 г.)

Разъемы специального, военного и аэрокосмического назначения:

(Применяются в военной, авиационной, аэрокосмической, морской, железнодорожной, горно- и нефтедобывающей отраслях промышленности)

«FORSTAR» (основан в 1998 г.)

ВЧ соединители, коаксиальные кабели, кабельные сборки и микроволновые компоненты:

(Применяются в телекоммуникациях гражданского и специального назначения, в средствах связи, РЛС, а так же военной, авиационной и аэрокосмической отраслях промышленности).



Телефон: 8 (812) 309-75-97 (многоканальный)

Факс: 8 (812) 320-03-32

Электронная почта: [ocean@oceanchips.ru](mailto:ocean@oceanchips.ru)

Web: <http://oceanchips.ru/>

Адрес: 198099, г. Санкт-Петербург, ул. Калинина, д. 2, корп. 4, лит. А