

Description

The AP3441 and AP3441L is a 3A step-down DC-DC converter. At heavy load, the constant-frequency PWM control performs excellent stability and transient response. No external compensation components are required.

The AP3441/L supports a range of input voltages from 2.7V to 5.5V allowing the use of a single Li+/Li-polymer cell, multiple Alkaline/NiMH cell, and other standard power sources. The output voltage is adjustable from 0.6V to the input voltage. The AP3441/L employs internal power switch and synchronous rectifier to minimize external part count and realize high efficiency. During shutdown, the input is disconnected from the output and the shutdown current is less than 1 μ A. Other key features include over-temperature and short circuit protection, and under-voltage lockout to prevent deep battery discharge.

The AP3441/L delivers 3A maximum output current while consuming only 55 μ A of no-load quiescent current. Ultra-low $R_{DS(ON)}$ integrated MOSFETs and 100% duty cycle operation make the AP3441/L an ideal choice for high output voltage, high current applications which require a low dropout threshold. Pulse skip mode to maintain high efficiency at light-load conditions.

The AP3441/L is available in W-DFN2020-8 (Type C) package.

Features

- Input Voltage: 2.7V to 5.5V
- Output Voltage: 0.6V to V_{IN}
- 0.6V Reference Voltage with $\pm 1.5\%$ Precision
- 55 μ A (Typ) No Load Quiescent Current
- Shutdown Current: <1 μ A
- 100% Duty Cycle Operation
- 1MHz Switching Frequency
- No External Compensation Required
- Short Circuit Protection
 - AP3441L: Latch Off Protection
 - AP3441: Hiccup Mode Protection
- Over Voltage Protection
 - AP3441L: Latch Off Protection
 - AP3441: Non Latch Off Protection
- Thermal Shutdown
- W-DFN2020-8 (Type C) Package
- **Totally Lead-Free & Fully RoHS Compliant (Notes 1 & 2)**
- **Halogen and Antimony Free. "Green" Device (Note 3)**

Notes:

1. No purposely added lead. Fully EU Directive 2002/95/EC (RoHS), 2011/65/EU (RoHS 2) & 2015/863/EU (RoHS 3) compliant.
2. See <https://www.diodes.com/quality/lead-free/> for more information about Diodes Incorporated's definitions of Halogen- and Antimony-free, "Green" and Lead-free.
3. Halogen- and Antimony-free "Green" products are defined as those which contain <900ppm bromine, <900ppm chlorine (<1500ppm total Br + Cl) and <1000ppm antimony compounds.

Pin Assignments

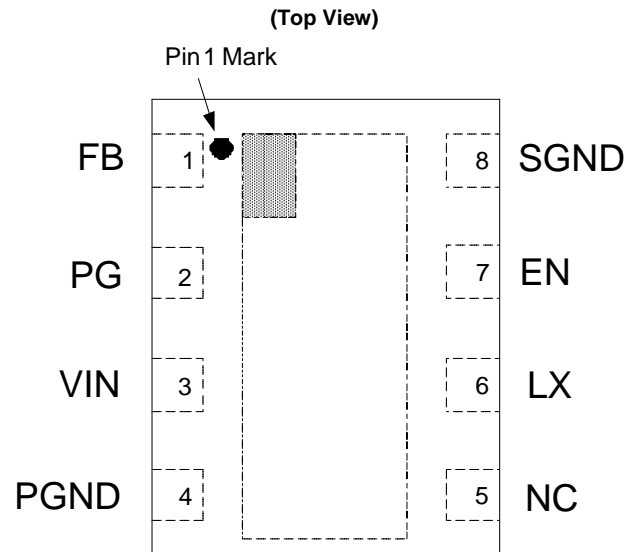

W-DFN2020-8 (Type C)

Applications

- Post DC-DC Voltage Regulation
- Set Top Boxes
- Notebook Computer
- PAD

Typical Applications Circuit

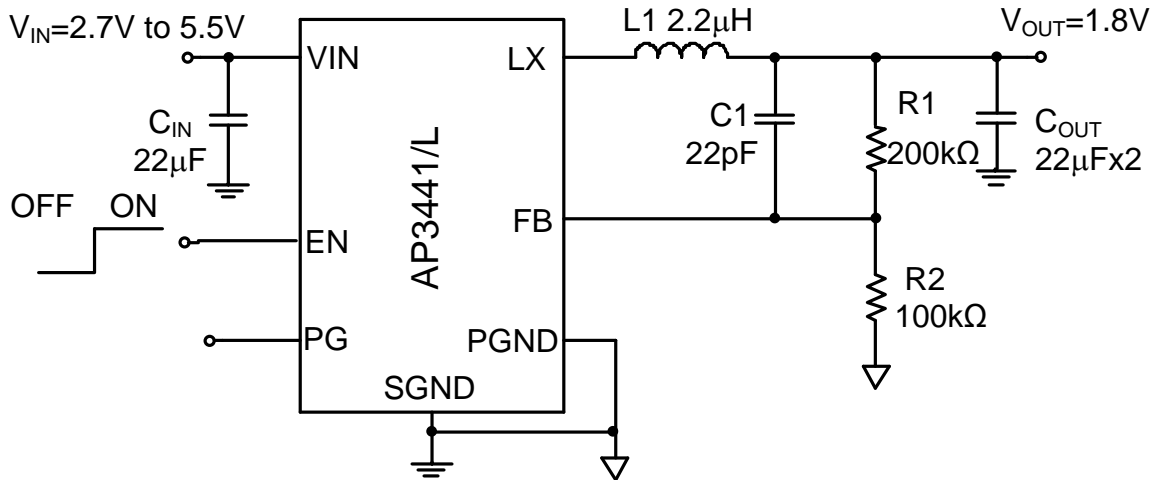

Pin Descriptions

Pin Number	Pin Name	Function
1	FB	Feedback voltage to internal error amplifier, the threshold voltage is 0.6V.
2	PG	Power good indicator, open drain output. PG is pulled up to VIN when the output voltage is within 20% of the regulation level, otherwise it is low.
3	VIN	Bias supply. Chip main power supply pin
4	PGND	Power ground pin
5	NC	No connection
6	LX	The drains of the internal main and synchronous power MOSFET.
7	EN	Enable control input. Force this pin voltage above 1.5V enables the chip, and below 0.4V shuts down the device.
8	SGND	Signal ground pin

NEW PRODUCT

Functional Block Diagram

NEW PRODUCT

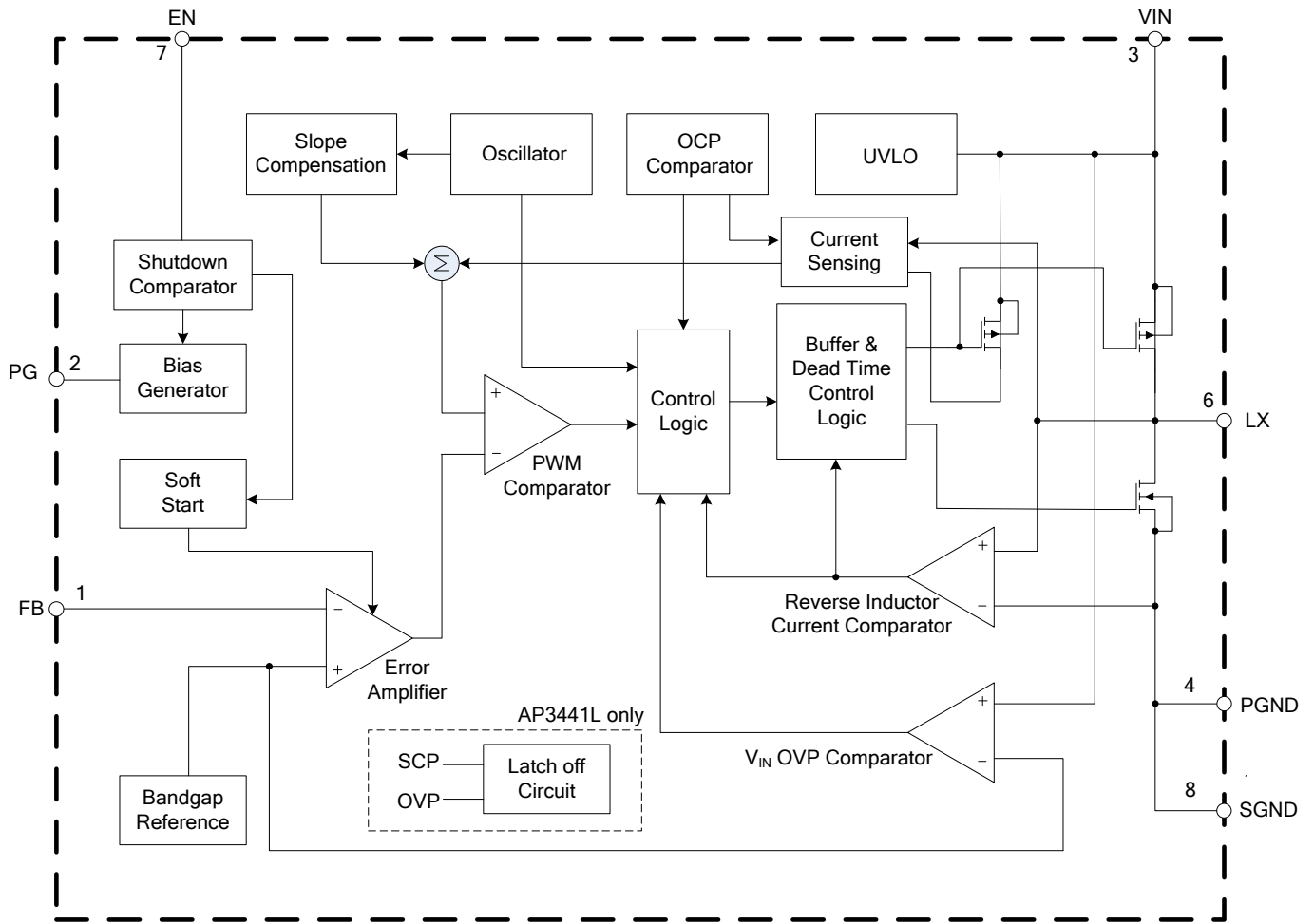

Functional Block Diagram of AP3441/L

Absolute Maximum Ratings (Note 4)

Symbol	Parameter	Rating	Unit
V_{IN}	Input Voltage	-0.3 to 6	V
V_{EN}	EN Pin Voltage	-0.3 to $V_{IN}+0.3$	V
V_{FB}	FB Pin Voltage	-0.3 to $V_{IN}+0.3$	V
V_{LX}	LX Pin Voltage	-0.3 to $V_{IN}+0.3$	V
V_{LX}	LX Pin Voltage	-3 to $V_{IN}+3$ for $<20nS$	V
V_{FB}	Feedback Pin Voltage	-0.3 to $V_{IN}+0.3$	V
P_D	Power Dissipation (On PCB, $T_A = +25^{\circ}C$)	1.4	W
θ_{JA}	Thermal Resistance (Junction to Ambient)	70	$^{\circ}C/W$
θ_{JC}	Thermal Resistance (Junction to Case, Simulation)	8.2	$^{\circ}C/W$
T_J	Operating Junction Temperature	+150	$^{\circ}C$
T_{STG}	Storage Temperature	-55 to +150	$^{\circ}C$
V_{HBM}	ESD (Human Body Model, JESD22-A114)	2000	V
V_{CDM}	ESD (Charge Device Mode, JESD22-C101)	1000	V

Note: 4. Stresses greater than those listed under "Absolute Maximum Ratings" may cause permanent damage to the device. These are stress ratings only and functional operation of the device at these or any other conditions beyond those indicated under "Recommended Operating Conditions" are not implied. Exposure to "Absolute Maximum Ratings" for extended periods may affect device reliability.

Recommended Operating Conditions

Symbol	Parameter	Min	Max	Unit
V_{IN}	Supply Voltage	2.7	5.5	V
T_J	Junction Temperature Range	-40	+125	$^{\circ}C$
T_A	Operating Ambient Temperature	-40	+85	$^{\circ}C$

Electrical Characteristics (@T_A = +25°C, V_{IN} = 5.0V, V_{OUT} = 2.5V, C_{OUT} = 22μF*2, L = 2.2μH, unless otherwise specified.)

Symbol	Parameters	Conditions	Min	Typ	Max	Unit
VIN						
V _{IN}	Input Voltage Range	–	2.7	–	5.5	V
V _{OUT}	Output Voltage Range	–	0.6	–	V _{IN}	V
I _Q	Quiescent Current	V _{FB} = 0.65V	–	55	–	μA
I _{SD}	Shutdown Current	V _{EN} = 0V	–	0.1	1	μA
V _{UVLO}	Input UVLO Threshold	V _{IN} Rises	–	2.4	2.5	V
V _{HYS}	Input UVLO Hysteresis	V _{IN} Falls	–	0.2	–	V
Feedback Input						
V _{FB}	Regulated Feedback Voltage	–	0.591	0.6	0.609	V
I _{FB}	FB Leakage Current	V _{FB} = 1V	–	–	0.2	μA
I _{LIM}	Peak Inductor Current	–	3.5	–	–	A
Oscillator						
f _{OSC}	Oscillator Frequency	–	0.8	1	1.2	MHz
D _{MAX}	Maximum Duty Cycle	–	100	–	–	%
MOSFET						
R _{DS(ON)}	Drain-Source On-State Resistance	I _{LX} = 100mA High Side	–	72	–	mΩ
		I _{LX} = 100mA Low Side	–	53	–	mΩ
R _{DISCH}	Output Discharge Switch On Resister	–	–	50	–	Ω
EN Pin						
V _{ENH}	EN Threshold High	–	1.5	–	–	V
V _{ENL}	EN Threshold Low	–	–	–	0.4	V
I _{EN}	EN Leakage Current	V _{IN} = V _{EN} = 5V	-1.0	–	1.0	μA
Protection						
V _{SCP}	Short Circuit Protection Latch Off Threshold	AP3441L only	–	0.42	–	V
t _{DELAY_SCP}	Short Circuit Protection Delay Time	–	–	30	–	μs
T _{OTP}	Over Temperature Protection	–	–	+150	–	°C
T _{DTH}	OTP Hysteresis	–	–	+20	–	°C
V _{OVp}	Vout Over Voltage Protection	AP3441L only	–	0.72	–	V
V _{IOVP}	V _{IN} Over Voltage Protection	V _{IN} Rises	–	6.3	–	V
V _{IHSY}	IOVP Hysteresis	V _{IN} Falls	–	0.35	–	V
Soft Start						
t _{SS}	Soft-start Time	–	0.7	1.0	1.3	ms

Typical Performance Characteristics (@ $T_A = +25^\circ\text{C}$, $V_{IN} = 5\text{V}$, $V_{OUT} = 1.8\text{V}$, unless otherwise specified.)

Efficiency vs. Load Current

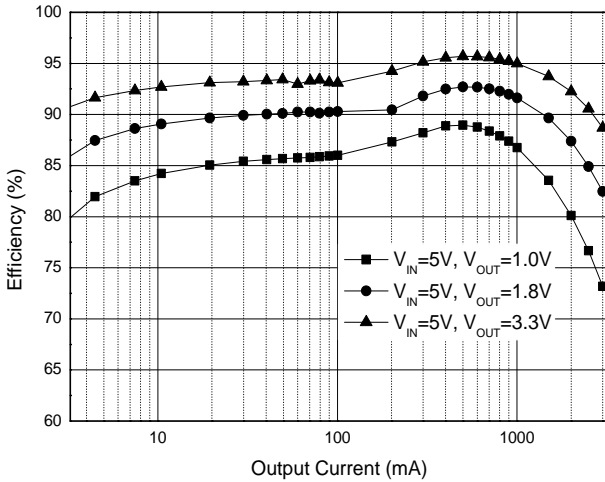

Output Voltage vs. Output Current

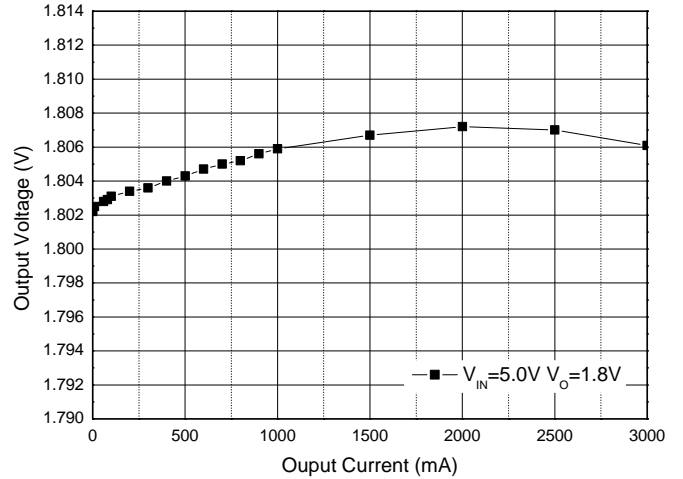

Output Voltage vs. Input Voltage

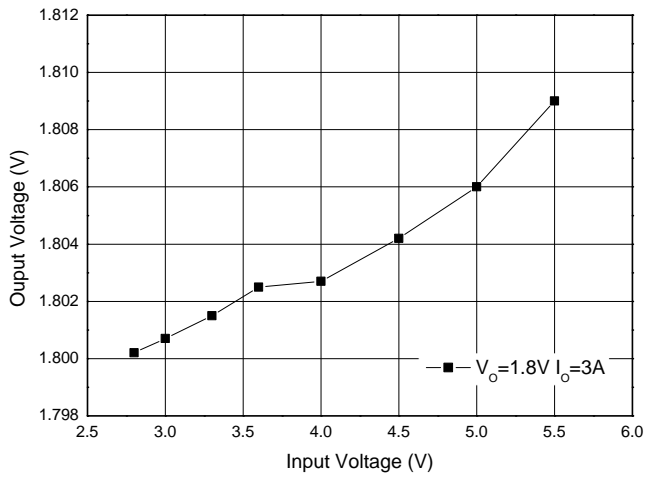

Feedback Reference Voltage vs. Temperature

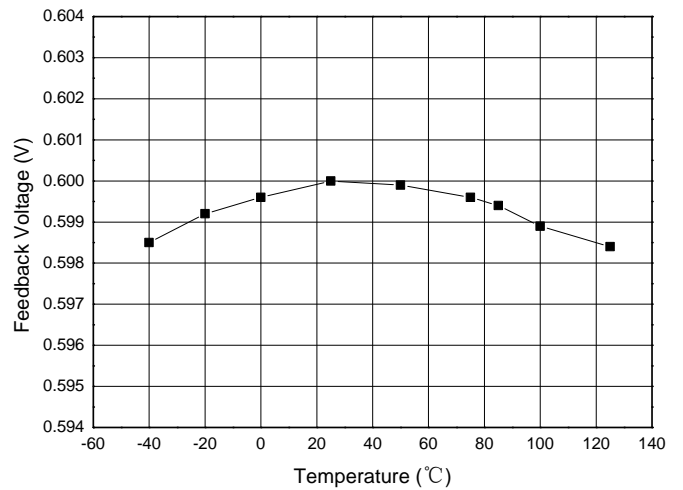

PFET Drain-Source On-State Resistance vs. Temperature

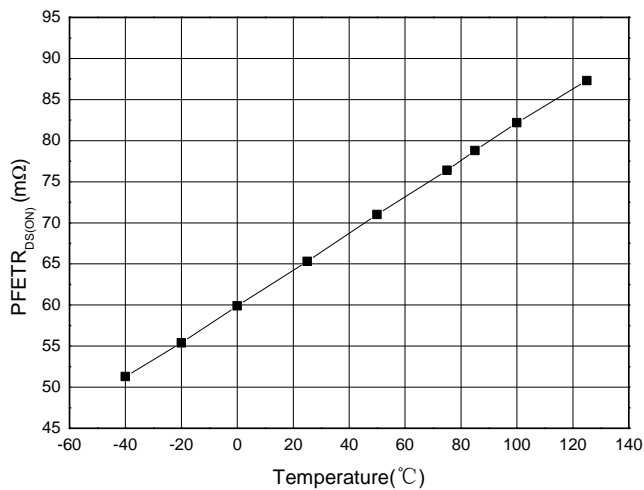

NFET Drain-Source On-State Resistance vs. Temperature

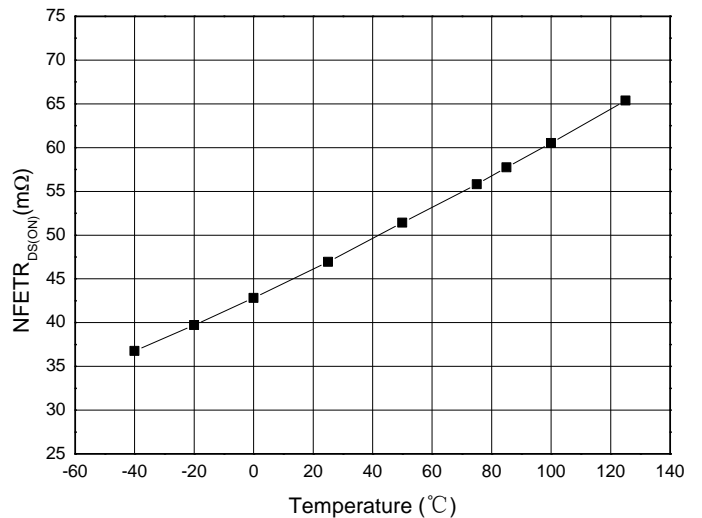

Typical Performance Characteristics (@ $T_A = +25^\circ\text{C}$, $V_{IN} = 5\text{V}$, $V_{OUT} = 1.8\text{V}$, unless otherwise specified.)

NEW PRODUCT

Inductor Current Limit vs. Temperature

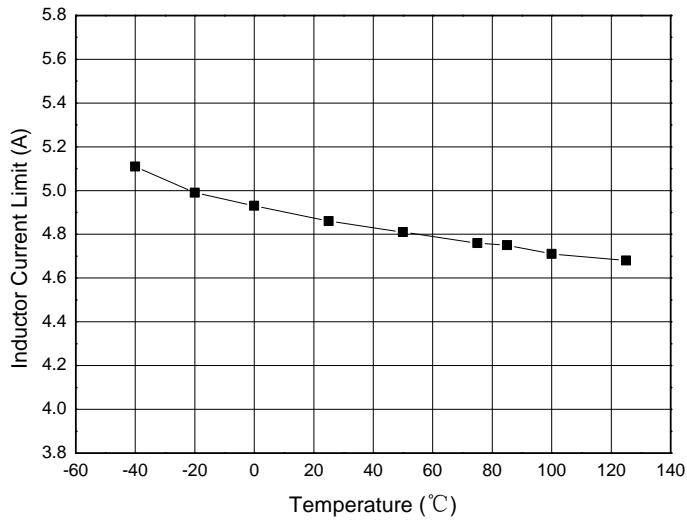

Oscillation Frequency vs. Temperature

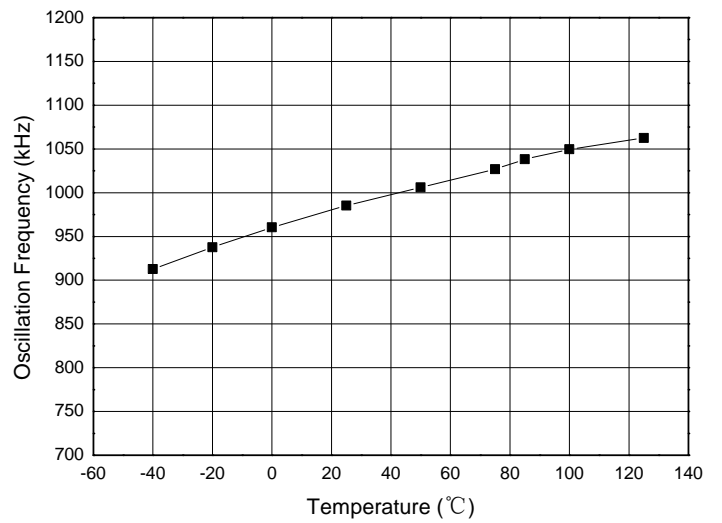

Typical Performance Characteristics (@T_A = +25°C, V_{IN} = 5V, V_{OUT} = 1.8V, unless otherwise specified.)

Enable Turn on Characteristic (I_{OUT}=3A)

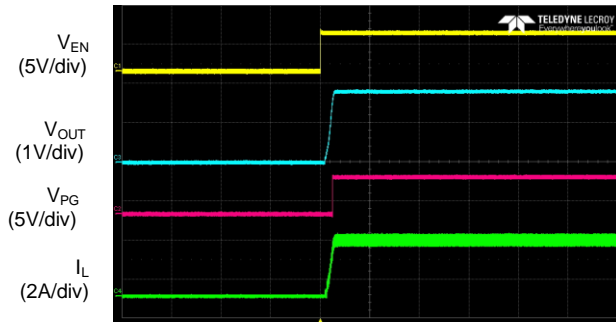

Enable Turn off Characteristic (I_{OUT}=3A)

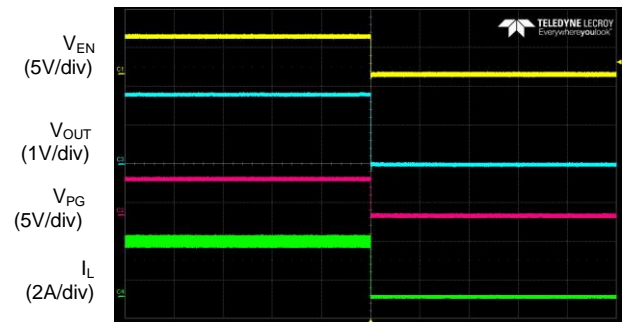

Output Ripple (I_{OUT}=0A)

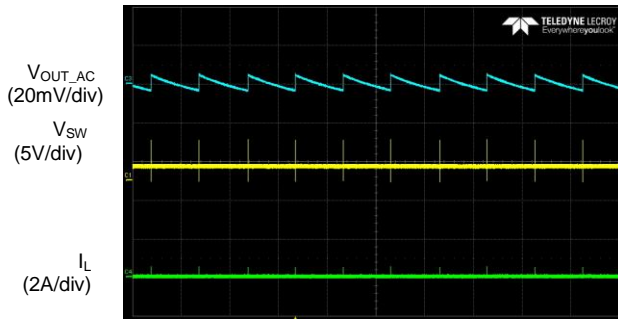

Output Ripple (I_{OUT}=3A)

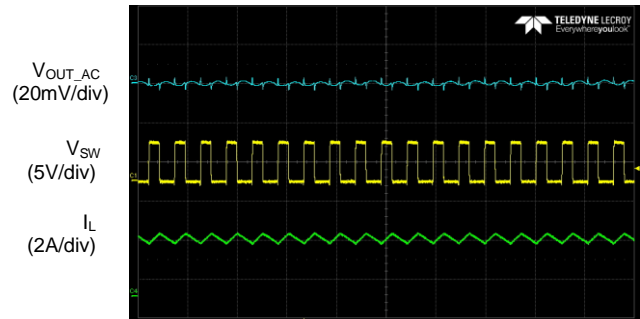

Load Transient (I_{OUT}=0.5A to 3A)

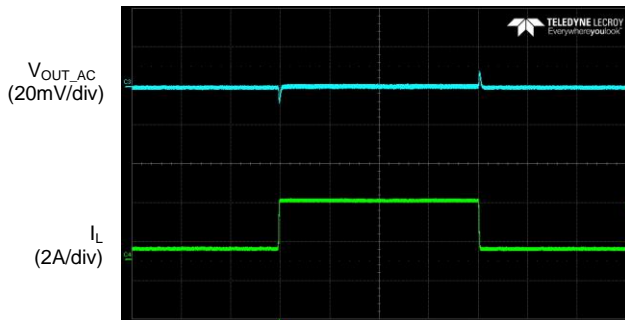

Load Transient (I_{OUT}=2A to 3A)

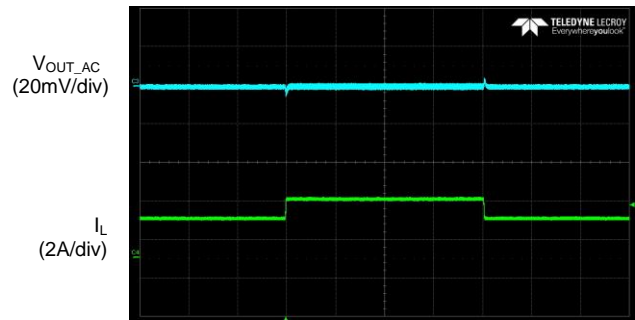

Short Current Protection (I_{OUT}=3A) for AP3441

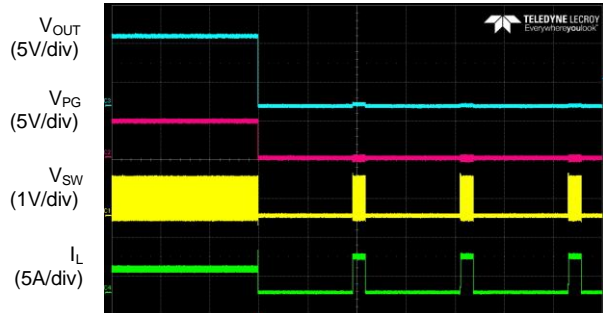

SCP Recovery (I_{OUT}=3A) for AP3441

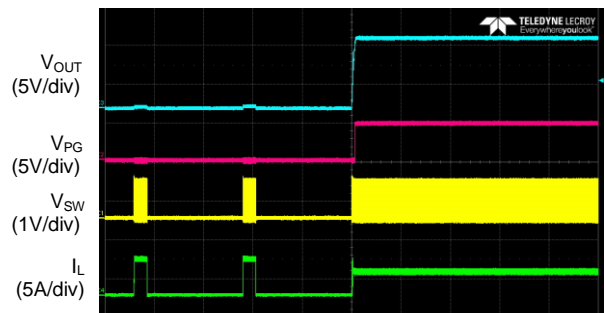

Application Information

The AP3441/L is a 3A current mode control, synchronous buck regulator with integrated power MOSFETs. Current mode control assures excellent line regulation, load regulation, and a wide loop bandwidth for fast response to load transients. See the typical application schematic and functional block diagram of AP3441/L for more details. The buck controller drives the internal high side P-FETs. The buck regulator can operate from an unregulated DC source, such as a battery, with a voltage ranging from 2.7V to 5.5V. The converter output can be regulated as low as 0.6V to as high as V_{IN} . The feedback loop is compensated internally.

Under Voltage Lockout (UVLO) Circuit

When the V_{IN} drops lower than the UVLO detector threshold, the UVLO circuit starts to operate, V_{REF} stops, and high-side switch and low-side switch built-in switch transistors turn “OFF”. As a result, V_{OUT} drops according to the C_{OUT} capacitance value and the load. When the V_{IN} is rising higher than UVLO released voltage, the IC will restart the operation.

Short Circuit Protection and Recovery

When the AP3441/L output node is shorted to GND that V_{FB} drops under 0.42V, AP3441 will enter hiccup mode to protect itself and AP3441L will enter latch-off mode. If short condition is removed, and V_{FB} rises over 0.42V, the AP3441 recovers to normal operation again. AP3441L will remain in this state until V_{IN} or EN voltage is recycled. If the AP3441/L reaches OCP threshold while short circuit, the AP3441 will enter cycle by cycle current limit mode until the current under OCP threshold.

Over Voltage Protection (AP3441L Only)

The AP3441L has internal output OVP circuits. When V_{OUT} is exceeds 120% of the regulation level for more than 40 μ s, the power switches will be turned off. AP3441L enters latch off mode and will restart until V_{IN} or Enable voltage recycled.

Over Temperature Protection

The internal thermal temperature protection circuitry is provided to protect the integrated circuit in the event that the maximum junction temperature is exceeded. When the junction temperature exceeds +150°C, it shuts down the internal control circuit and switching power MOSFET. The AP3441/L will restart automatically under the control of soft start circuit when the junction temperature decreases to +130°C.

Setting the Output Voltage

Choose R1 and R2 to program the proper output voltage. Resistor R1 is selected based on a design tradeoff between efficiency and output voltage accuracy. For high values of R1 there is less current consumption in the feedback network. However the tradeoff is output voltage accuracy due to the bias current in the error amplifier. Table 1 shows a list of resistors selection for common output voltages. An optional C1 of 10pF to 470pF used to boost the phase margin and improve stability. R2 in figure 6 can be determined by the following equation:

$$R_2 = \frac{R_1 \cdot 0.6}{V_{OUT} - 0.6}$$

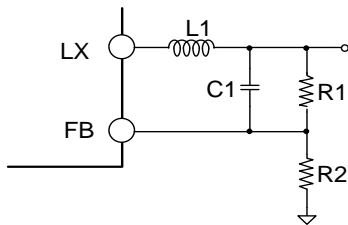

Figure 1. Feedback Divider Network

V _{OUT} (V)	R1 (k Ω)	R2 (k Ω)	C1 (pF)	L1 (μ H)
1.0V	68k Ω	100k Ω	22pF	1.0 μ H
1.2V	100k Ω	100k Ω	22pF	1.0 μ H
1.5V	150k Ω	100k Ω	22pF	1.5 – 2.2 μ H
1.8V	200k Ω	100k Ω	22pF	1.5 – 2.2 μ H
2.5V	317k Ω	100k Ω	22pF	2.2 μ H
2.8V	367k Ω	100k Ω	22pF	2.2 μ H

Table 1. Recommended Component Selection

Application Information

Input Capacitor

The input capacitor reduces the surge current drawn from the input supply and the switching noise from the device. The input capacitor has to sustain the ripple current produced during the on time on the upper MOSFET. It must hence have a low ESR to minimize the losses.

The RMS current rating of the input capacitor is a critical parameter that must be higher than the RMS input current. As a rule of thumb, select an input capacitor which has RMS rating that is greater than half of the maximum load current.

Due to large di/dt through the input capacitors, electrolytic or ceramics should be used. If a tantalum must be used, it must be surge protected. Otherwise, capacitor failure could occur. For most applications, a 22µF ceramic capacitor is sufficient.

Output Capacitor

The output capacitor keeps the output voltage ripple small, ensures feedback loop stability and reduces the overshoot of the output voltage. The output capacitor is a basic component for the fast response of the power supply. In fact, during load transient, for the first few microseconds it supplies the current to the load. The converter recognizes the load transient and sets the duty cycle to maximum, but the current slope is limited by the inductor value.

ESR of the output capacitor dominates the output voltage ripple. The amount of ripple can be calculated from the equation below:

$$V_{OUT_CAPACITOR} = \Delta I_{INDUCTOR} * ESR$$

An output capacitor with ample capacitance and low ESR is the best option. For most applications, 2x22µF ceramic capacitor will be sufficient.

$$C_O = \frac{L(I_{OUT} + \frac{\Delta I_{INDUCTOR}}{2})^2}{(\Delta V + V_{OUT})^2 - V_{OUT}^2}$$

Where ΔV is the maximum output voltage overshoot.

Inductor Selection

The inductor is used to supply smooth current to output when it is driven by a switching voltage. Its value is determined based on the operating frequency, load current, ripple current, and duty cycle. For most application, the value of the inductor will fall in the range of 1.0µH to 2.2µH. Choose an inductor that has small DC resistance, has enough current rating and is hard to cause magnetic saturation.

Vo	L(µH)
1.0V	1.0µH
1.2V	1.0µH
1.5V	1.5 – 2.2µH
1.8V	1.5 – 2.2µH
2.5V	2.2µH
2.8V	2.2µH
3.3V	2.2µH

Table 2: Recommended Inductor Selection Table

Ordering Information

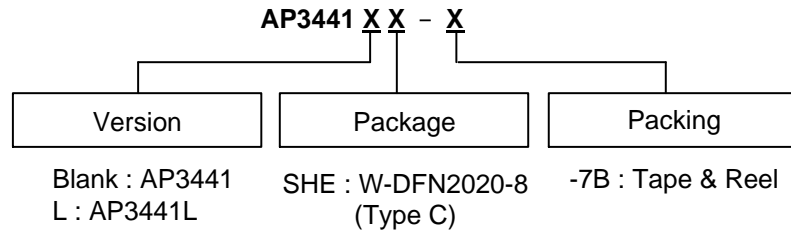

Package	Temperature Range	Part Number	Marking ID	Packing
W-DFN2020-8 (Type C)	-40 to +85°C	AP3441SHE-7B	9B	-7B
W-DFN2020-8 (Type C)	-40 to +85°C	AP3441LSHE-7B	9C	-7B

Marking Information

(1) W-DFN2020-8 (Type C)

(Top View)

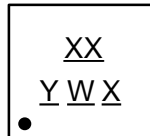

- XX : Identification Code
- Y : Year : 0~9
- W : Week : A~Z : 1~26 week;
a~z : 27~52 week; z represents
52 and 53 week
- X : Internal Code

Package Outline Dimensions

Please see <http://www.diodes.com/package-outlines.html> for the latest version.

(1) Package Type: W-DFN2020-8 (Type C)

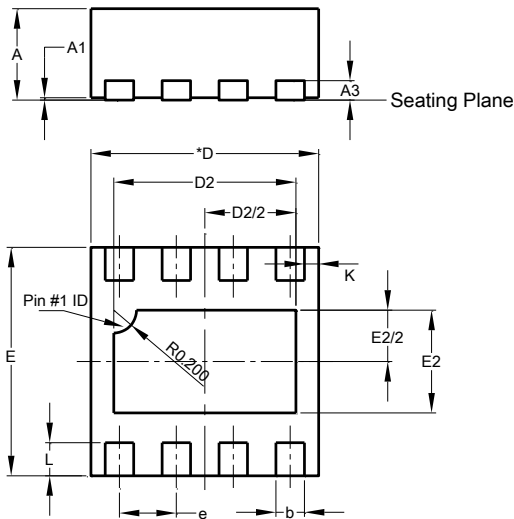

W-DFN2020-8 (Type C)			
Dim	Min	Max	Typ
A	0.770	0.830	0.800
A1	0	0.05	0.02
A3	-	-	0.152
b	0.20	0.30	0.25
D	1.950	2.075	2.000
D2	1.50	1.70	1.60
E	1.950	2.075	2.000
E2	0.80	1.00	0.90
e	-	-	0.50
K	-	-	0.1 5
L	0.240	0.340	0.290
All Dimensions in mm			

Suggested Pad Layout

Please see <http://www.diodes.com/package-outlines.html> for the latest version.

(1) Package Type: W-DFN2020-8 (Type C)

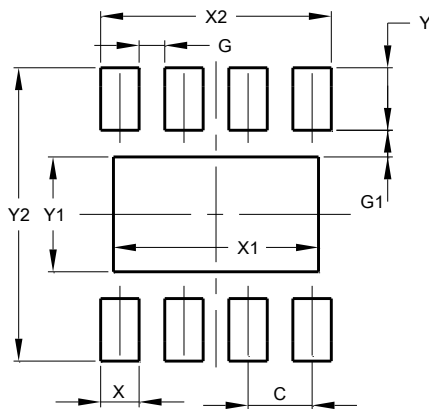

Dimensions	Value (in mm)
C	0.500
G	0.200
G1	0.210
X	0.300
X1	1.600
X2	1.750
Y	0.490
Y1	0.900
Y2	2.300

Taping & Reel Specification

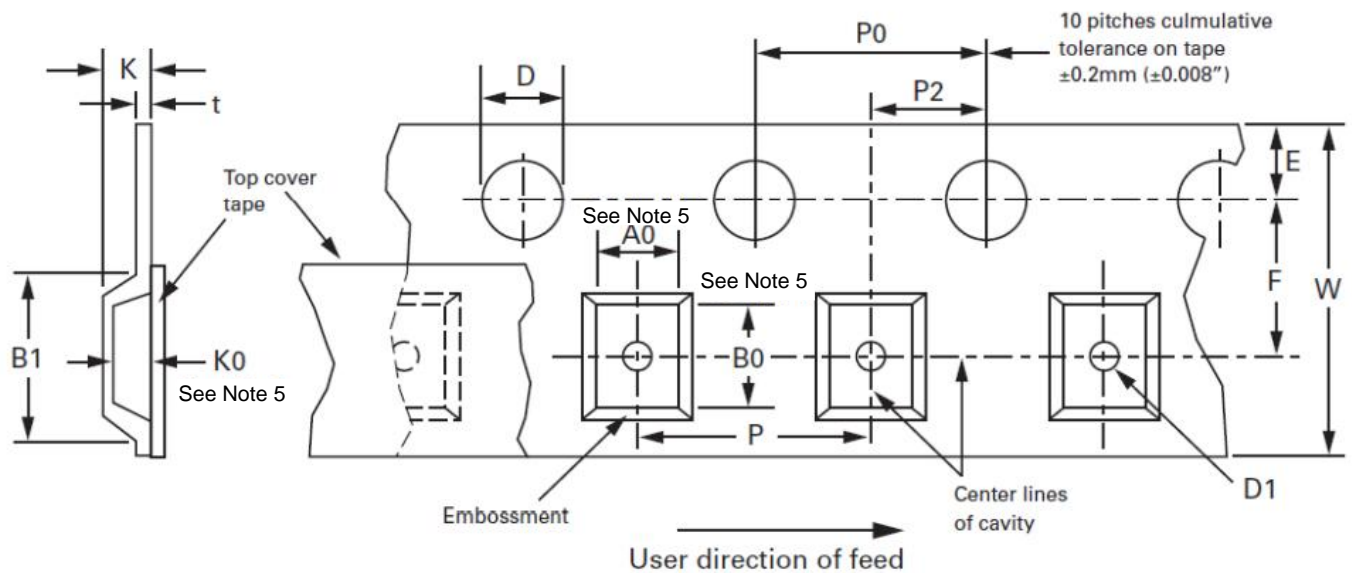
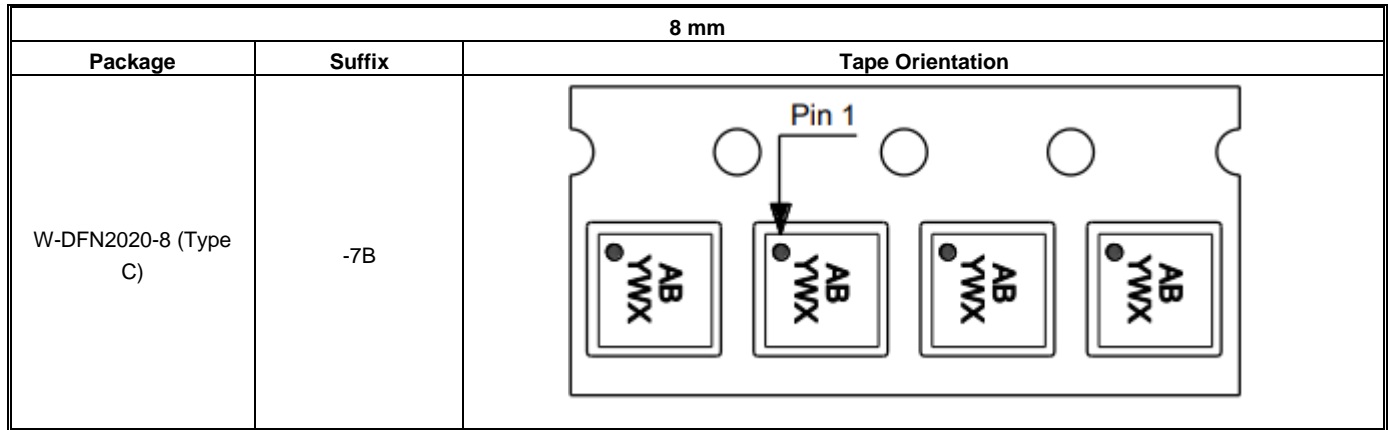

EMBOSSED TAPE DIMENSIONS in mm						
Tape Width	D	E	Po	t max	Ao Bo Ko	-
8mm	1.50 +0.10 -0.0	1.75 ±0.10	4.0± 0.10	0.400	Note 5	Constant Dimensions

EMBOSSED TAPE DIMENSIONS in mm							
Tape Width	B1 max	D1 min	F	K max	P2	R min	W
8mm	4.5	1.0	3.5± 0.05	2.4	2.0± 0.05	25	8.0± 0.30

Note: 5. Ao, Bo and Ko are determined by component size.

Taping & Reel Specification (Cont.)

Surface Mount Reel Specifications (All Dimensions in mm)

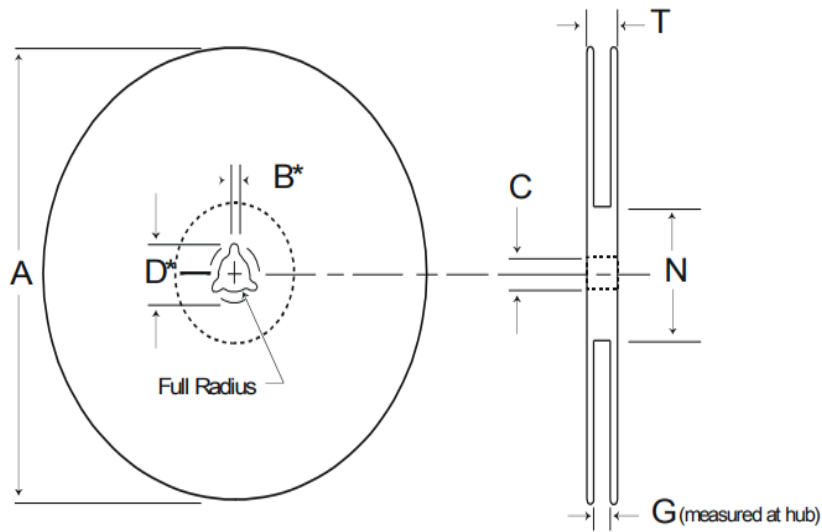

* Drive spokes optional. If used, dimensions with asterisks apply.

Tape Size	A Max	B* Max	C	D* Max	N Min	G	T Max
8mm	330±2	2.0 +0.5 -0	13 +0.5 -0.2	20.5±0.2	100±2	8.4 +1.5 -0	14.4
	178±2	2.0 +0.5 -0	13 +0.5 -0.2	20.5±0.2	55±5	8.4 +1.5 -0	14.4

NEW PRODUCT

IMPORTANT NOTICE

DIODES INCORPORATED MAKES NO WARRANTY OF ANY KIND, EXPRESS OR IMPLIED, WITH REGARDS TO THIS DOCUMENT, INCLUDING, BUT NOT LIMITED TO, THE IMPLIED WARRANTIES OF MERCHANTABILITY AND FITNESS FOR A PARTICULAR PURPOSE (AND THEIR EQUIVALENTS UNDER THE LAWS OF ANY JURISDICTION).

Diodes Incorporated and its subsidiaries reserve the right to make modifications, enhancements, improvements, corrections or other changes without further notice to this document and any product described herein. Diodes Incorporated does not assume any liability arising out of the application or use of this document or any product described herein; neither does Diodes Incorporated convey any license under its patent or trademark rights, nor the rights of others. Any Customer or user of this document or products described herein in such applications shall assume all risks of such use and will agree to hold Diodes Incorporated and all the companies whose products are represented on Diodes Incorporated website, harmless against all damages.

Diodes Incorporated does not warrant or accept any liability whatsoever in respect of any products purchased through unauthorized sales channel. Should Customers purchase or use Diodes Incorporated products for any unintended or unauthorized application, Customers shall indemnify and hold Diodes Incorporated and its representatives harmless against all claims, damages, expenses, and attorney fees arising out of, directly or indirectly, any claim of personal injury or death associated with such unintended or unauthorized application.

Products described herein may be covered by one or more United States, international or foreign patents pending. Product names and markings noted herein may also be covered by one or more United States, international or foreign trademarks.

This document is written in English but may be translated into multiple languages for reference. Only the English version of this document is the final and determinative format released by Diodes Incorporated.

LIFE SUPPORT

Diodes Incorporated products are specifically not authorized for use as critical components in life support devices or systems without the express written approval of the Chief Executive Officer of Diodes Incorporated. As used herein:

A. Life support devices or systems are devices or systems which:

1. are intended to implant into the body, or
2. support or sustain life and whose failure to perform when properly used in accordance with instructions for use provided in the labeling can be reasonably expected to result in significant injury to the user.

B. A critical component is any component in a life support device or system whose failure to perform can be reasonably expected to cause the failure of the life support device or to affect its safety or effectiveness.

Customers represent that they have all necessary expertise in the safety and regulatory ramifications of their life support devices or systems, and acknowledge and agree that they are solely responsible for all legal, regulatory and safety-related requirements concerning their products and any use of Diodes Incorporated products in such safety-critical, life support devices or systems, notwithstanding any devices- or systems-related information or support that may be provided by Diodes Incorporated. Further, Customers must fully indemnify Diodes Incorporated and its representatives against any damages arising out of the use of Diodes Incorporated products in such safety-critical, life support devices or systems.

Copyright © 2018, Diodes Incorporated

www.diodes.com

Компания «Океан Электроники» предлагает заключение долгосрочных отношений при поставках импортных электронных компонентов на взаимовыгодных условиях!

Наши преимущества:

- Поставка оригинальных импортных электронных компонентов напрямую с производств Америки, Европы и Азии, а так же с крупнейших складов мира;
- Широкая линейка поставок активных и пассивных импортных электронных компонентов (более 30 млн. наименований);
- Поставка сложных, дефицитных, либо снятых с производства позиций;
- Оперативные сроки поставки под заказ (от 5 рабочих дней);
- Экспресс доставка в любую точку России;
- Помощь Конструкторского Отдела и консультации квалифицированных инженеров;
- Техническая поддержка проекта, помощь в подборе аналогов, поставка прототипов;
- Поставка электронных компонентов под контролем ВП;
- Система менеджмента качества сертифицирована по Международному стандарту ISO 9001;
- При необходимости вся продукция военного и аэрокосмического назначения проходит испытания и сертификацию в лаборатории (по согласованию с заказчиком);
- Поставка специализированных компонентов военного и аэрокосмического уровня качества (Xilinx, Altera, Analog Devices, Intersil, Interpoint, Microsemi, Actel, Aeroflex, Peregrine, VPT, Syfer, Eurofarad, Texas Instruments, MS Kennedy, Miteq, Cobham, E2V, MA-COM, Hittite, Mini-Circuits, General Dynamics и др.);

Компания «Океан Электроники» является официальным дистрибьютором и эксклюзивным представителем в России одного из крупнейших производителей разъемов военного и аэрокосмического назначения «JONHON», а так же официальным дистрибьютором и эксклюзивным представителем в России производителя высокотехнологичных и надежных решений для передачи СВЧ сигналов «FORSTAR».



JONHON

«JONHON» (основан в 1970 г.)

Разъемы специального, военного и аэрокосмического назначения:

(Применяются в военной, авиационной, аэрокосмической, морской, железнодорожной, горно- и нефтедобывающей отраслях промышленности)

«FORSTAR» (основан в 1998 г.)

ВЧ соединители, коаксиальные кабели, кабельные сборки и микроволновые компоненты:

(Применяются в телекоммуникациях гражданского и специального назначения, в средствах связи, РЛС, а так же военной, авиационной и аэрокосмической отраслях промышленности).



Телефон: 8 (812) 309-75-97 (многоканальный)

Факс: 8 (812) 320-03-32

Электронная почта: ocean@oceanchips.ru

Web: <http://oceanchips.ru/>

Адрес: 198099, г. Санкт-Петербург, ул. Калинина, д. 2, корп. 4, лит. А