

MMIC VCO w/ HALF FREQUENCY OUTPUT & DIVIDE-BY-4, 11.1 - 12.4 GHz



Typical Applications

Low noise MMIC VCO w/Half Frequency, Divide-by-4 Outputs for:

- Point to Point/Multipoint Radio
- Test Equipment & Industrial Controls
- SATCOM
- Military End-Use

Features

Triple Output: Fo = 11.1 - 12.4 GHz
 Fo/2 = 5.55 - 6.2 GHz
 Fo/4 = 2.78 - 3.1 GHz

Pout: +9 dBm

Phase Noise: -110 dBc/Hz @100 kHz Typ.

No External Resonator Needed

32 Lead 5x5mm SMT Package: 25mm²

Functional Diagram

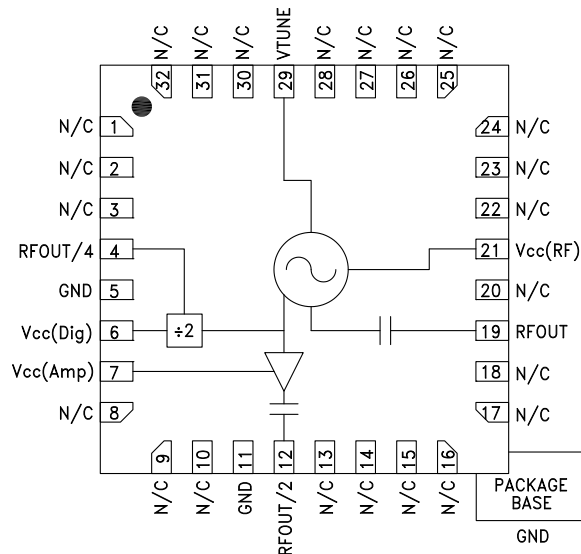

General Description

The HMC582LP5 & HMC582LP5E are GaAs InGaP Heterojunction Bipolar Transistor (HBT) MMIC VCOs. The HMC582LP5 & HMC582LP5E integrate resonators, negative resistance devices, varactor diodes and feature half frequency and divide-by-4 outputs. The VCO's phase noise performance is excellent over temperature, shock, and process due to the oscillator's monolithic structure. Power output is +9 dBm typical from a +5V supply voltage. The prescaler and RF/2 functions can be disabled to conserve current if not required. The voltage controlled oscillator is packaged in a leadless QFN 5x5 mm surface mount package, and requires no external matching components.

Electrical Specifications, T_A = +25° C, Vcc (Dig), Vcc (Amp), Vcc (RF) = +5V

Parameter	Min.	Typ.	Max.	Units	
Frequency Range	Fo	11.1 - 12.4		GHz	
	Fo/2	5.55 - 6.2		GHz	
Power Output	RFOUT	+5	+12	dBm	
	RFOUT/2	+8	+14	dBm	
	RFOUT/4	-9	-3	dBm	
SSB Phase Noise @ 100 kHz Offset, Vtune= +5V @ RFOUT		-110		dBc/Hz	
Tune Voltage	Vtune	2	12	V	
Supply Current	Icc(Dig) + Icc(Amp) + Icc(RF)	290	350	390	mA
Tune Port Leakage Current (Vtune= 13V)			10	µA	
Output Return Loss		2		dB	
Harmonics/Subharmonics	1/2	32		dBc	
	2nd	25		dBc	
	3rd	30		dBc	
Pulling (into a 2.0:1 VSWR)		5		MHz pp	
Pushing @ Vtune= 5V		30		MHz/V	
Frequency Drift Rate		1.2		MHz/°C	

Information furnished by Analog Devices is believed to be accurate and reliable. However, no responsibility is assumed by Analog Devices for its use, nor for any infringements of patents or other rights of third parties that may result from its use. Specifications subject to change without notice. No license is granted by implication or otherwise under any patent or patent rights of Analog Devices. Trademarks and registered trademarks are the property of their respective owners.

For price, delivery, and to place orders: Analog Devices, Inc., One Technology Way, P.O. Box 9106, Norwood, MA 02062-9106
 Phone: 781-329-4700 • Order online at www.analog.com
 Application Support: Phone: 1-800-ANALOG-D

MMIC VCO w/ HALF FREQUENCY OUTPUT & DIVIDE-BY-4, 11.1 - 12.4 GHz



Frequency vs. Tuning Voltage, Vcc = +5V

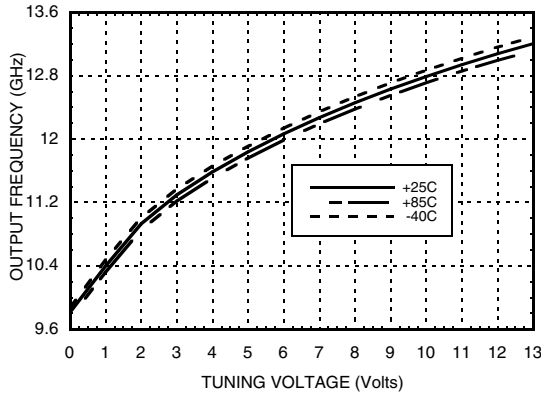

Frequency vs. Tuning Voltage, T = 25°C

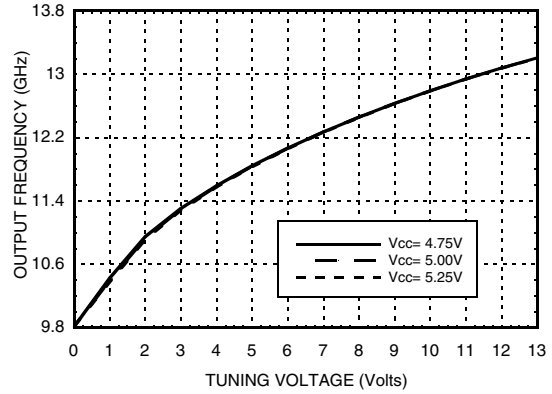

Sensitivity vs. Tuning Voltage, Vcc = +5V

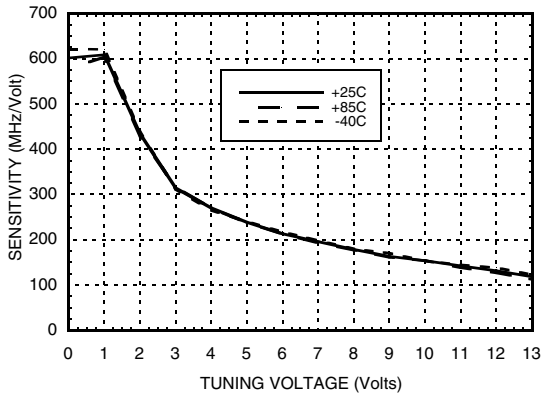

Output Power vs. Tuning Voltage, Vcc = +5V

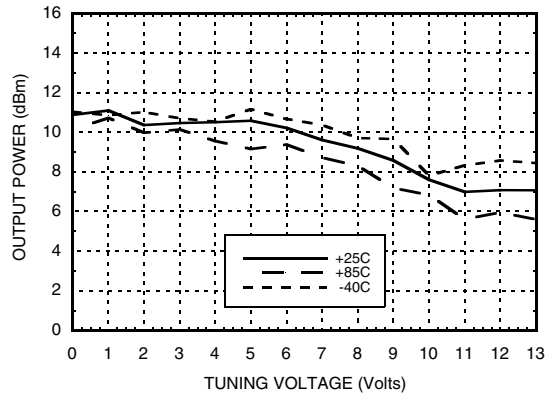

SSB Phase Noise vs. Tuning Voltage

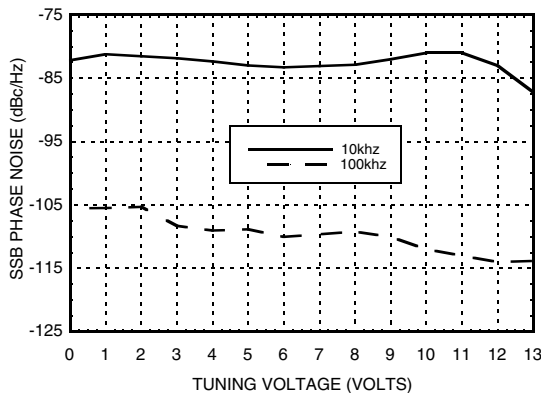

SSB Phase Noise @ Vtune = +5V

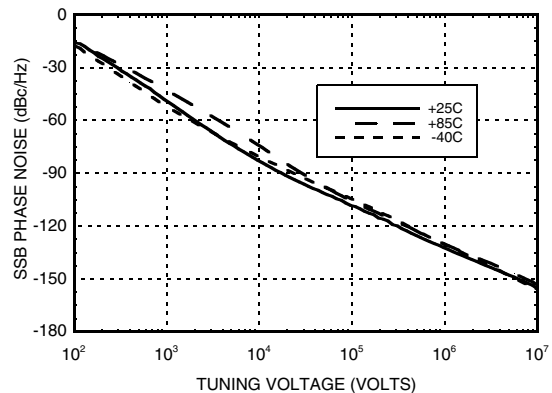

Information furnished by Analog Devices is believed to be accurate and reliable. However, no responsibility is assumed by Analog Devices for its use, nor for any infringements of patents or other rights of third parties that may result from its use. Specifications subject to change without notice. No license is granted by implication or otherwise under any patent or patent rights of Analog Devices. Trademarks and registered trademarks are the property of their respective owners.

For price, delivery, and to place orders: Analog Devices, Inc., One Technology Way, P.O. Box 9106, Norwood, MA 02062-9106 Phone: 781-329-4700 • Order online at www.analog.com Application Support: Phone: 1-800-ANALOG-D

MMIC VCO w/ HALF FREQUENCY OUTPUT & DIVIDE-BY-4, 11.1 - 12.4 GHz



RFOUT/2 Frequency vs. Tuning Voltage, Vcc = +5V

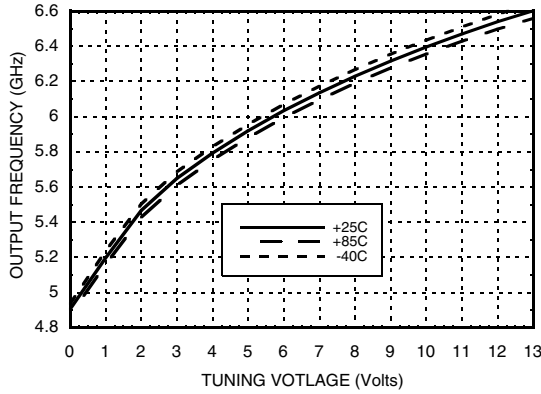

RFOUT/2 Output Power vs. Tuning Voltage, Vcc = +5V

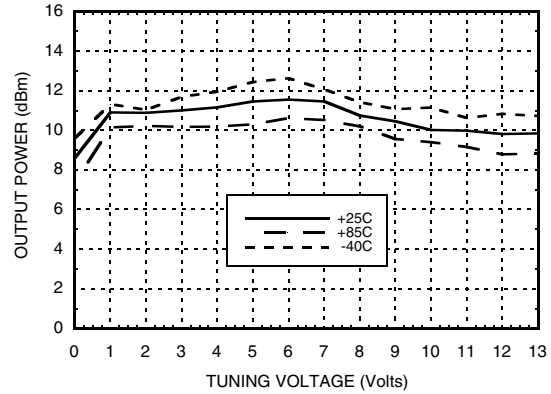

Divide-by-4 Frequency vs. Tuning Voltage, Vcc = +5V

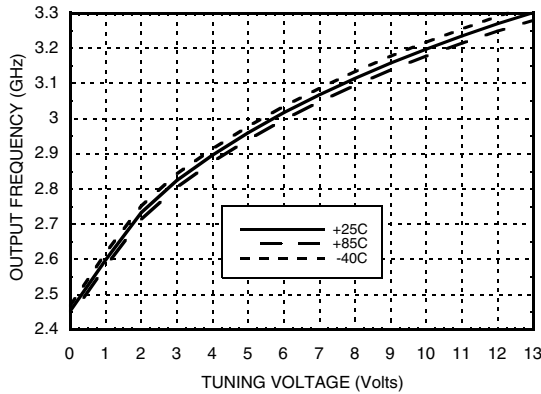

Divide-by-4 Output Power vs. Tuning Voltage, Vcc = +5V

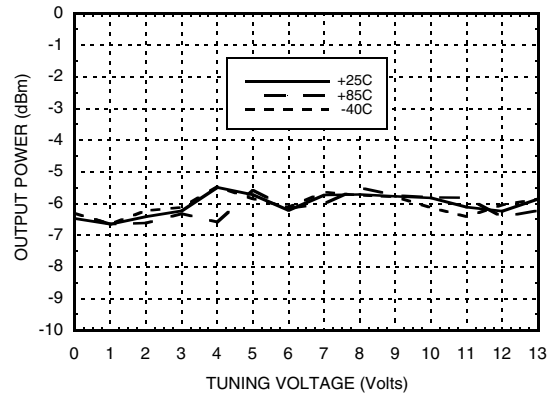

Absolute Maximum Ratings

Vcc(Dig), Vcc(Amp), Vcc(RF)	+5.5 Vdc
Vtune	0 to +15V
Junction Temperature	135 °C
Continuous P _{diss} (T=85 °C) (derate 43.5 mW/C above 85 °C)	2.17 W
Thermal Resistance (junction to ground paddle)	23 °C/W
Storage Temperature	-65 to +150 °C
Operating Temperature	-40 to +85 °C
ESD Sensitivity (HBM)	Class 1A

Typical Supply Current vs. Vcc

Vcc (V)	I _{cc} (mA)
4.75	320
5.00	350
5.25	380

Note: VCO will operate over full voltage range shown above.



**ELECTROSTATIC SENSITIVE DEVICE
OBSERVE HANDLING PRECAUTIONS**

MMIC VCO w/ HALF FREQUENCY OUTPUT & DIVIDE-BY-4, 11.1 - 12.4 GHz



Outline Drawing

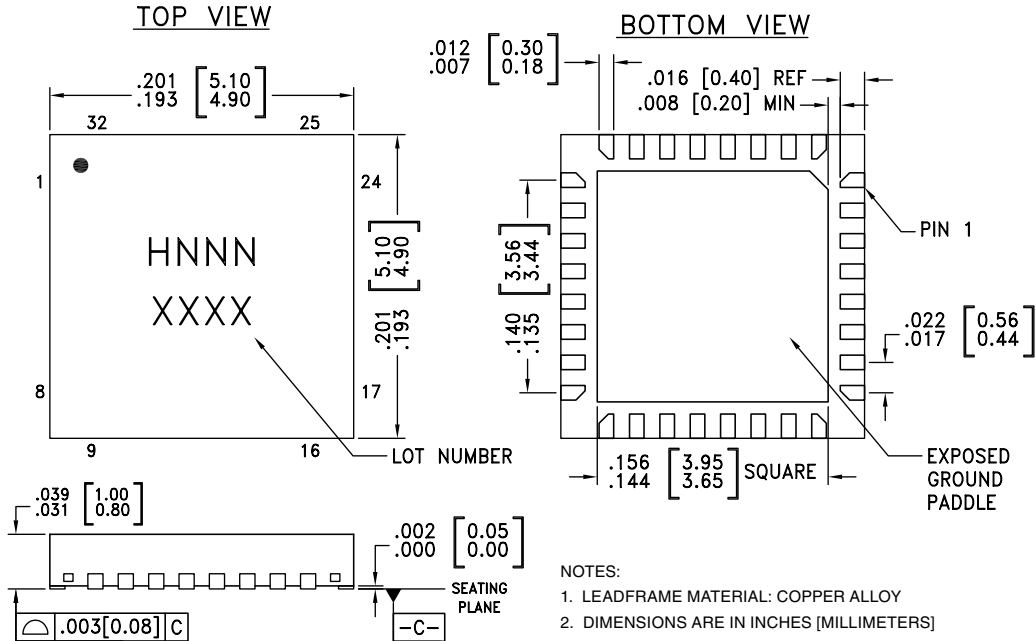

NOTES:

1. LEADFRAME MATERIAL: COPPER ALLOY
2. DIMENSIONS ARE IN INCHES [MILLIMETERS]
3. LEAD SPACING TOLERANCE IS NON-CUMULATIVE.
4. PAD BURR LENGTH SHALL BE 0.15mm MAXIMUM.
PAD BURR HEIGHT SHALL BE 0.05mm MAXIMUM.
5. PACKAGE WARP SHALL NOT EXCEED 0.05mm.
6. ALL GROUND LEADS AND GROUND PADDLE MUST BE SOLDERED TO PCB RF GROUND.
7. REFER TO HITTITE APPLICATION NOTE FOR SUGGESTED LAND PATTERN.

Package Information

Part Number	Package Body Material	Lead Finish	MSL Rating	Package Marking ^[3]
HMC582LP5	Low Stress Injection Molded Plastic	Sn/Pb Solder	MSL3 ^[1]	H582 XXXX
HMC582LP5E	RoHS-compliant Low Stress Injection Molded Plastic	100% matte Sn	MSL3 ^[2]	H582 XXXX

- [1] Max peak reflow temperature of 235 °C
 [2] Max peak reflow temperature of 260 °C
 [3] 4-Digit lot number XXXX

Pin Descriptions

Pin Number	Function	Description	Interface Schematic
1 - 3, 8 - 10, 13 - 18, 20, 22 - 28, 30 - 32	N/C	No Connection. These pins may be connected to RF/DC ground. Performance will not be affected.	
4	RFOUT/4	Divide-by-4 output. DC block required.	
6	Vcc (Dig)	Supply voltage for prescaler. If prescaler is not required, this pin may be left open to conserve approximately 65 mA of current.	

Information furnished by Analog Devices is believed to be accurate and reliable. However, no responsibility is assumed by Analog Devices for its use, nor for any infringements of patents or other rights of third parties that may result from its use. Specifications subject to change without notice. No license is granted by implication or otherwise under any patent or patent rights of Analog Devices. Trademarks and registered trademarks are the property of their respective owners.

For price, delivery, and to place orders: Analog Devices, Inc., One Technology Way, P.O. Box 9106, Norwood, MA 02062-9106
 Phone: 781-329-4700 • Order online at www.analog.com
 Application Support: Phone: 1-800-ANALOG-D

MMIC VCO w/ HALF FREQUENCY OUTPUT & DIVIDE-BY-4, 11.1 - 12.4 GHz



Pin Descriptions

Pin Number	Function	Description	Interface Schematic
7	Vcc (Amp)	Supply voltage for RFOUT/2 output. If RFOUT/2 is not required, this pin may be left open to conserve approximately 30 mA of current.	
12	RFOUT/2	Half frequency output (AC coupled).	
19	RF OUT	RF output (AC coupled).	
21	Vcc (RF)	Supply Voltage, +5V	
29	VTUNE	Control voltage and modulation input. Modulation bandwidth dependent on drive source impedance. See "Determining the FM Bandwidth of a Wideband Varactor Tuned VCO" application note.	
5, 11, Paddle	GND	Package bottom has an exposed metal paddle that must be connected to RF/DC ground.	

Typical Application Circuit

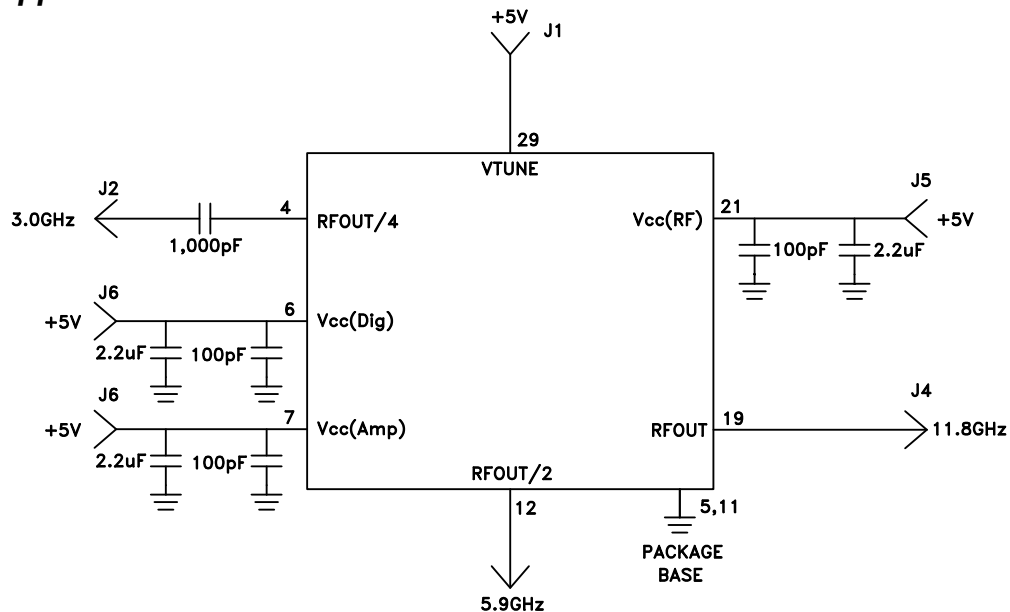

Information furnished by Analog Devices is believed to be accurate and reliable. However, no responsibility is assumed by Analog Devices for its use, nor for any infringements of patents or other rights of third parties that may result from its use. Specifications subject to change without notice. No license is granted by implication or otherwise under any patent or patent rights of Analog Devices. Trademarks and registered trademarks are the property of their respective owners.

For price, delivery, and to place orders: Analog Devices, Inc., One Technology Way, P.O. Box 9106, Norwood, MA 02062-9106
 Phone: 781-329-4700 • Order online at www.analog.com
 Application Support: Phone: 1-800-ANALOG-D

MMIC VCO w/ HALF FREQUENCY OUTPUT & DIVIDE-BY-4, 11.1 - 12.4 GHz



Evaluation PCB

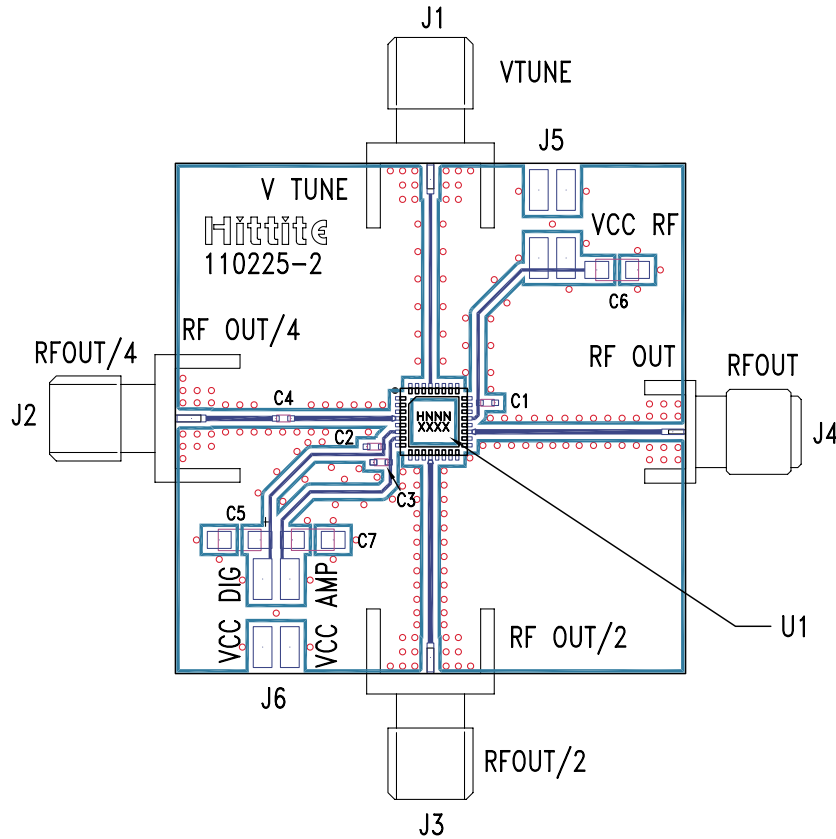

List of Materials for Evaluation PCB 110227 [1]

Item	Description
J1 - J4	PCB Mount SMA RF Connector
J5 - J6	2 mm DC Header
C1 - C3	100 pF Capacitor, 0402 Pkg.
C4	1,000 pF Capacitor, 0402 Pkg.
C5 - C7	2.2 μF Tantalum Capacitor
U1	HMC582LP5 / HMC582LP5E VCO
PCB [2]	110225 Eval Board

[1] Reference this number when ordering complete evaluation PCB

[2] Circuit Board Material: Rogers 4350

The circuit board used in the application should use RF circuit design techniques. Signal lines should have 50 Ohm impedance while the package ground leads and backside ground paddle should be connected directly to the ground plane similar to that shown. A sufficient number of via holes should be used to connect the top and bottom ground planes. The evaluation circuit board shown is available from Hittite upon request.

Компания «Океан Электроники» предлагает заключение долгосрочных отношений при поставках импортных электронных компонентов на взаимовыгодных условиях!

Наши преимущества:

- Поставка оригинальных импортных электронных компонентов напрямую с производств Америки, Европы и Азии, а так же с крупнейших складов мира;
- Широкая линейка поставок активных и пассивных импортных электронных компонентов (более 30 млн. наименований);
- Поставка сложных, дефицитных, либо снятых с производства позиций;
- Оперативные сроки поставки под заказ (от 5 рабочих дней);
- Экспресс доставка в любую точку России;
- Помощь Конструкторского Отдела и консультации квалифицированных инженеров;
- Техническая поддержка проекта, помощь в подборе аналогов, поставка прототипов;
- Поставка электронных компонентов под контролем ВП;
- Система менеджмента качества сертифицирована по Международному стандарту ISO 9001;
- При необходимости вся продукция военного и аэрокосмического назначения проходит испытания и сертификацию в лаборатории (по согласованию с заказчиком);
- Поставка специализированных компонентов военного и аэрокосмического уровня качества (Xilinx, Altera, Analog Devices, Intersil, Interpoint, Microsemi, Actel, Aeroflex, Peregrine, VPT, Syfer, Eurofarad, Texas Instruments, MS Kennedy, Miteq, Cobham, E2V, MA-COM, Hittite, Mini-Circuits, General Dynamics и др.);

Компания «Океан Электроники» является официальным дистрибьютором и эксклюзивным представителем в России одного из крупнейших производителей разъемов военного и аэрокосмического назначения «JONHON», а так же официальным дистрибьютором и эксклюзивным представителем в России производителя высокотехнологичных и надежных решений для передачи СВЧ сигналов «FORSTAR».



JONHON

«JONHON» (основан в 1970 г.)

Разъемы специального, военного и аэрокосмического назначения:

(Применяются в военной, авиационной, аэрокосмической, морской, железнодорожной, горно- и нефтедобывающей отраслях промышленности)

«FORSTAR» (основан в 1998 г.)

ВЧ соединители, коаксиальные кабели, кабельные сборки и микроволновые компоненты:

(Применяются в телекоммуникациях гражданского и специального назначения, в средствах связи, РЛС, а так же военной, авиационной и аэрокосмической отраслях промышленности).



Телефон: 8 (812) 309-75-97 (многоканальный)

Факс: 8 (812) 320-03-32

Электронная почта: ocean@oceanchips.ru

Web: <http://oceanchips.ru/>

Адрес: 198099, г. Санкт-Петербург, ул. Калинина, д. 2, корп. 4, лит. А