

## Description

The AH1902 is a high-sensitivity micropower Omnipolar Hall effect switch IC with internal pull up and pull down capability. Designed for portable and battery powered consumer equipment such as cellular phones and portable PCs to office equipment, home appliances and industrial applications, the average supply current is only 4.3µA at 1.8V. To support portable equipment the AH1902 can operate over the supply range of 1.6V to 3.6V and uses a hibernating clocking system to minimize the power consumption. To minimize PCB space, the AH1902 is available in small low profile X1-DFN1216-4, X2-DFN2015-6 and SOT553 packages.

The output is activated with either a north or south pole of sufficient magnetic field strength. When the magnetic flux density (B) perpendicular to the package is larger than operate point (Bop), the output will be turned on (pulled low) and held until B is lower than release point (Brp).

## Features

- Omnipolar Operation (North or South Pole)
- Supply Voltage of 1.6V to 3.6V
- High Sensitivity
- Micropower Operation
- Chopper Stabilized Design Provides:
  - Superior Temperature Stability
  - Minimal Switch Point Drift
  - Enhanced Immunity to Physical Stress
- No External Pull-up Resistors Required
- Good RF Noise Immunity
- -40°C to +85°C Operating Temperature
- High ESD capability of 8kV (Human Body Model)
- Small Low Profile X1-DFN1216-4, X2-DFN2015-6 and SOT553 Packages
- **Totally Lead-Free & Fully RoHS Compliant (Notes 1 & 2)**
- **Halogen and Antimony Free. "Green" Device (Note 3)**

- Notes:
1. EU Directive 2002/95/EC (RoHS) & 2011/65/EU (RoHS 2) compliant. All applicable RoHS exemptions applied.
  2. See [http://www.diodes.com/quality/lead\\_free.html](http://www.diodes.com/quality/lead_free.html) for more information about Diodes Incorporated's definitions of Halogen- and Antimony-free, "Green" and Lead-free.
  3. Halogen- and Antimony-free "Green" products are defined as those which contain <900ppm bromine, <900ppm chlorine (<1500ppm total Br + Cl) and <1000ppm antimony compounds.

## Pin Assignments

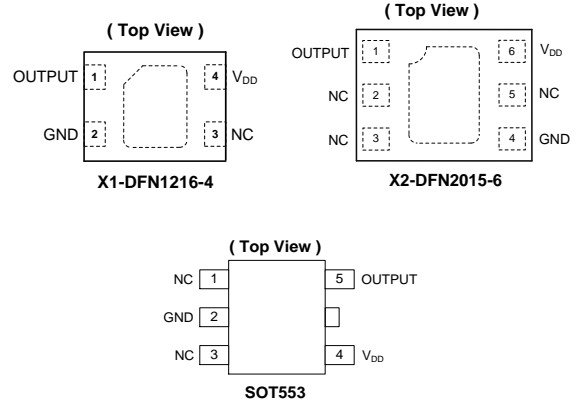

## Applications

- Open and Close Detect for Flip/Slide Cellular Phones
- Smart Cover or Dock Detect for Cellular Phones and Tablet PCs
- Cover or Display Switch in Portable PCs (eg: Ultrabook)
- Digital Still, Video Cameras and Handheld Gaming Consoles
- Door, Lids and Tray Position Switches
- Level, Proximity and Position Switches
- Contact-Less Switches in Home Appliances and Industrial Applications

## Typical Applications Circuit

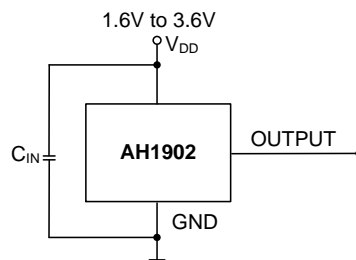

- Note: 4. C<sub>IN</sub> is for power stabilization and to strengthen the noise immunity, the recommended capacitance is 100nF typical and should be placed as close to the supply pin as possible.

## Pin Descriptions

### Package: X1-DFN1216-4

Pin Number	Pin Name	Function
1	OUTPUT	Output Pin
2	GND	Ground Pin
3	NC	No Connection (Note 5)
4	V <sub>DD</sub>	Power Supply Input
Pad	Pad	The center exposed pad – No connection internally. The exposed pad can be left open (unconnected to ) on the PCB layout.

### Package: X2-DFN2015-6

Pin Number	Pin Name	Function
1	OUTPUT	Output Pin
2	NC	No Connection (Note 5)
3	NC	No Connection (Note 5)
4	GND	Ground Pin
5	NC	No Connection (Note 5)
6	V <sub>DD</sub>	Power Supply Input
Pad	Pad	The center exposed pad – No connection internally. The exposed pad can be left open (unconnected to) on the PCB layout.

### Package: SOT553

Pin Number	Pin Name	Function
1	NC	No Connection (Note 5)
2	GND	Ground Pin
3	NC	No Connection (Note 5)
4	V <sub>DD</sub>	Power Supply Input
5	OUTPUT	Output Pin

Note: 5. NC is "No Connection" pin and is not connected internally. This pin can be left open or tied to ground.

## Functional Block Diagram

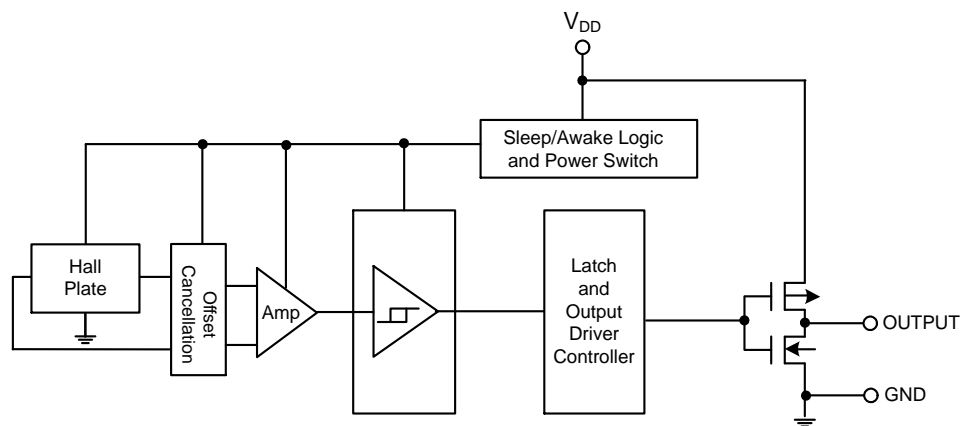

**Absolute Maximum Ratings** (Note 6) (@T<sub>A</sub> = +25°C, unless otherwise specified.)

Symbol	Parameter		Rating	Unit
V <sub>DD</sub>	Supply Voltage (Note 7)		6	V
V <sub>DD_REV</sub>	Reverse Supply Voltage		-0.3	V
I <sub>OUTPUT</sub>	Output Current (source and sink)		3	mA
B	Magnetic Flux Density		Unlimited	
P <sub>D</sub>	Package Power Dissipation	X1-DFN1216-4 and X2-DFN2015-6	230	mW
		SOT553	230	mW
T <sub>s</sub>	Storage Temperature Range		-65 to +150	°C
T <sub>J</sub>	Maximum Junction Temperature		+150	°C
ESD HBM	Human Body Model (HMB) ESD capability		8	kV

- Notes:
- Stresses greater than the 'Absolute Maximum Ratings' specified above may cause permanent damage to the device. These are stress ratings only; functional operation of the device at these or any other conditions exceeding those indicated in this specification is not implied. Device reliability may be affected by exposure to absolute maximum rating conditions for extended periods of time.
  - The absolute maximum V<sub>DD</sub> of 6V is a transient stress rating and is not meant as a functional operating condition. It is not recommended to operate the device at the absolute maximum rated conditions for any period of time.

**Recommended Operating Conditions** (@T<sub>A</sub> = +25°C, unless otherwise specified.)

Symbol	Parameter	Conditions	Rating	Unit
V <sub>DD</sub>	Supply Voltage	Operating	1.6V to 3.6V	V
T <sub>A</sub>	Operating Temperature Range	Operating	-40 to +85	°C

**Electrical Characteristics** (@T<sub>A</sub> = +25°C, V<sub>DD</sub> = 1.8V, unless otherwise specified.)

Symbol	Parameter	Conditions	Min	Typ	Max	Unit
V <sub>OL</sub>	Output Low Voltage (on)	I <sub>OUT</sub> = 1mA	—	0.1	0.2	V
V <sub>OH</sub>	Output High Voltage (off)	I <sub>OUT</sub> = -1mA	V <sub>DD</sub> -0.2	V <sub>DD</sub> -0.1	—	V
I <sub>off</sub>	Output Leakage Current	V <sub>OUT</sub> = 3.6V, Output off	—	< 0.1	1	µA
I <sub>DD(awake)</sub>	Supply Current	During 'awake' period, T <sub>A</sub> = +25°C, V <sub>DD</sub> = 3V	—	2.1	—	mA
I <sub>DD(sleep)</sub>		During 'sleep' period, T <sub>A</sub> = +25°C, V <sub>DD</sub> = 3V	—	2.5	—	µA
I <sub>DD(avg)</sub>	Average Supply Current	T <sub>A</sub> = +25°C, V <sub>DD</sub> = 1.8V	—	4.3	8	µA
		T <sub>A</sub> = +25°C, V <sub>DD</sub> = 3.6V	—	7.2	13	µA
T <sub>awake</sub>	Awake Time	(Note 8)	—	50	100	µs
T <sub>period</sub>	Period	(Note 8)	—	50	100	ms
D.C.	Duty Cycle	—	—	0.1	—	%

- Note:
- When power is initially turned on, the operating V<sub>DD</sub> (1.6V to 3.6V) must be applied to guaranteed the output sampling. The output state is valid after the second operating cycle (typical 100ms).

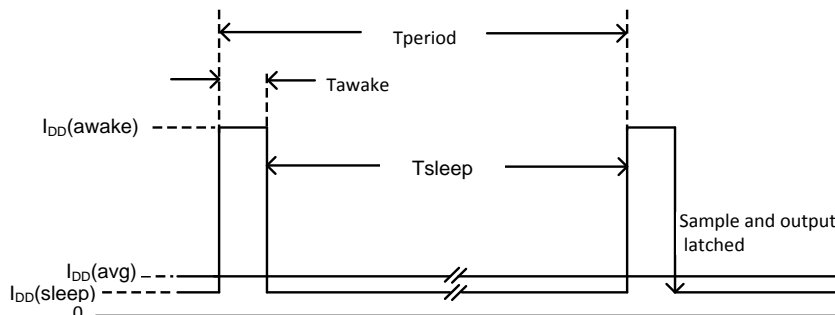

**Magnetic Characteristics** (Note 9 & 10) ( $T_A = +25^\circ\text{C}$ ,  $V_{DD} = 1.8\text{V}$ , unless otherwise specified)

(1mT=10 Gauss)

Symbol	Characteristics	Test Condition	Min	Typ	Max	Unit
Bops (south pole to part marking side)	Operation Point	—	23	33	47	Gauss
		$V_{DD} = 1.6\text{V to } 3.6\text{V}$ $T_A = -40^\circ\text{C to } +85^\circ\text{C}$	21	33	48	
Bopn (north pole to part marking side)		—	-47	-33	-24	
	Release Point	$V_{DD} = 1.6\text{V to } 3.6\text{V}$ $T_A = -40^\circ\text{C to } +85^\circ\text{C}$	-48	-33	-21	
Brps (south pole to part marking side)		—	12	23	35	
		$V_{DD} = 1.6\text{V to } 3.6\text{V}$ $T_A = -40^\circ\text{C to } +85^\circ\text{C}$	9	23	38	
Brpn (north pole to part marking side)	Hysteresis	—	-35	-23	-12	
Bhy ( $ B_{opx}  -  B_{rpx} $ )		$V_{DD} = 1.6\text{V to } 3.6\text{V}$ $T_A = -40^\circ\text{C to } +85^\circ\text{C}$	-38	-23	-9	
		—	—	10	—	

- Notes:
- Typical data is at  $T_A = +25^\circ\text{C}$ ,  $V_{DD} = 1.8\text{V}$ .
  - Maximum and minimum parameters values over operating temperature range are not tested in production, they are guaranteed by design, characterization and process control. The magnetic characteristics may vary with supply voltage, operating temperature and after soldering.

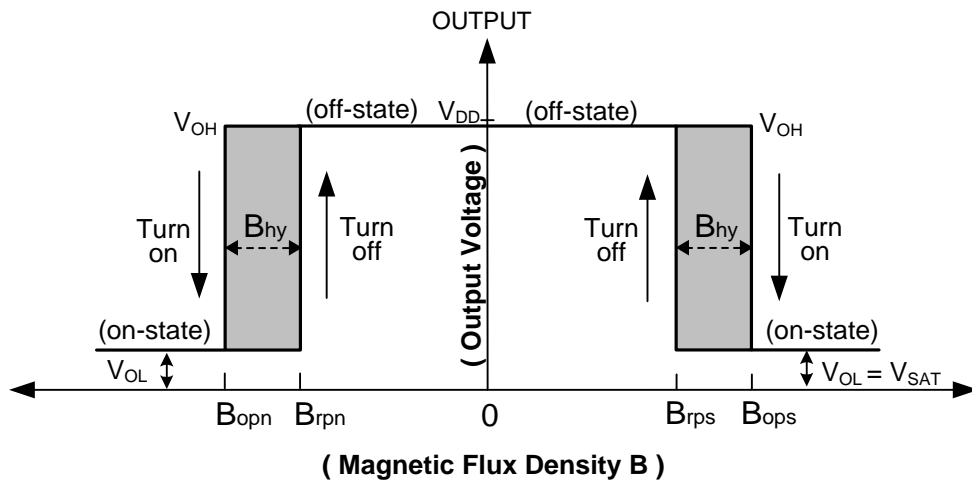

**Typical Operating Characteristics**

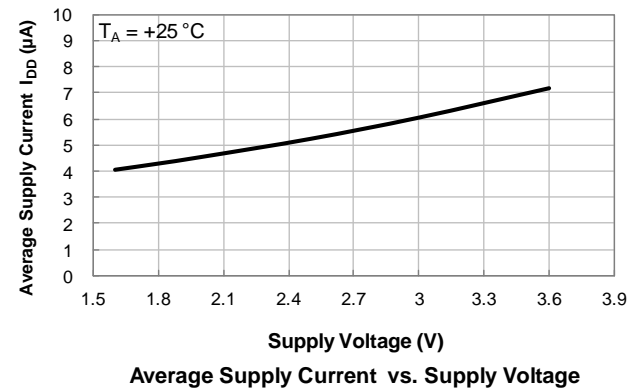
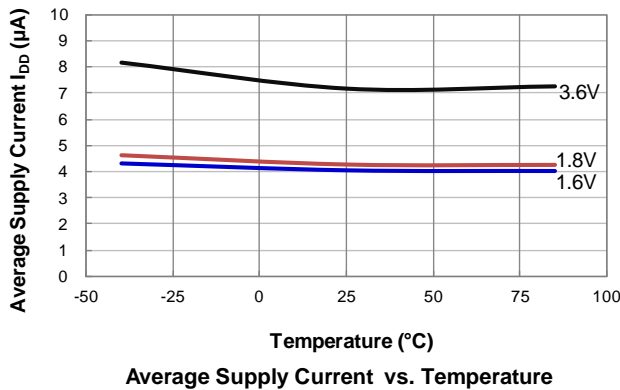
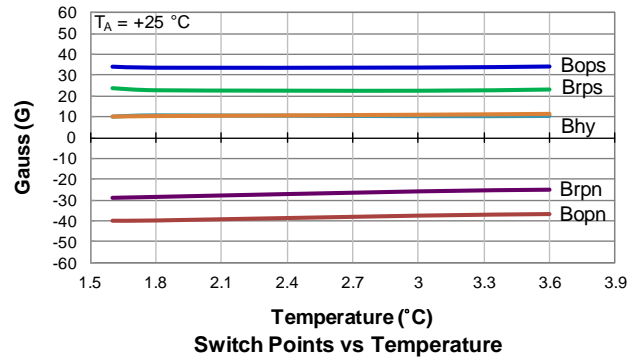
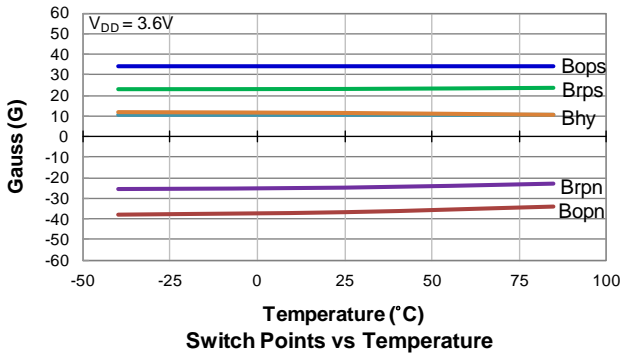
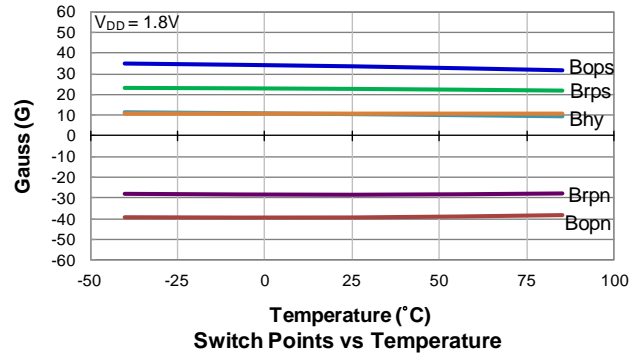
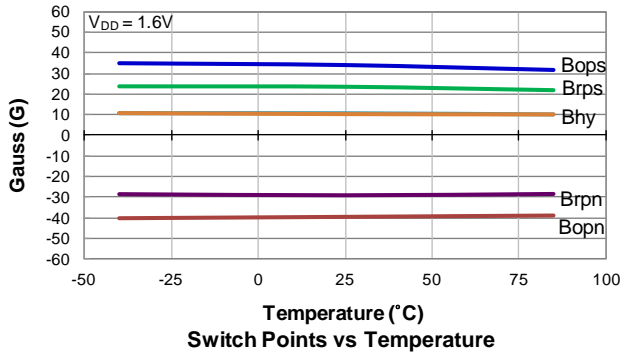

**Ordering Information**

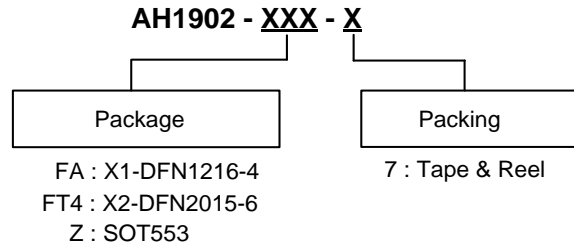

Part Number	Package Code	Packaging	7" Tape and Reel	
			Quantity	Part Number Suffix
AH1902-FA-7	FA	X1-DFN1216-4	3,000/Tape & Reel	-7
AH1902-FT4-7	FT4	X2-DFN2015-6	3,000/Tape & Reel	-7
AH1902-Z-7	Z	SOT553	3,000/Tape & Reel	-7

**Marking Information**

(1) Package Type: X1-DFN1216-4 and X2-DFN2015-6

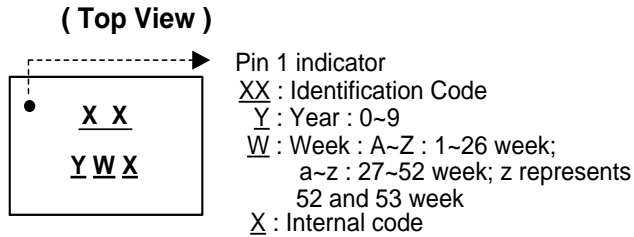

Part Number	Package	Identification Code
AH1902-FA-7	X1-DFN1216-4	F2
AH1902-FT4-7	X2-DFN2015-6	D2

(2) Package Type: SOT553

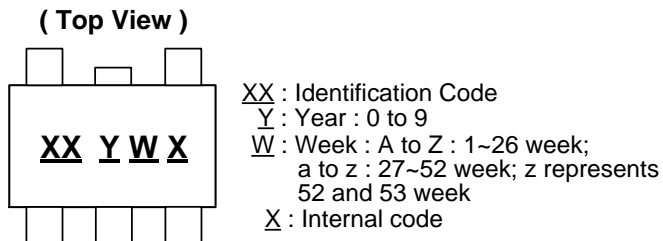

Part Number	Package	Identification Code
AH1902-Z-7	SOT553	D2

**Package Outline Dimensions** (All dimensions in mm.)

Please see <http://www.diodes.com/package-outlines.html> for the latest version.

(1) Package Type: X1-DFN1216-4

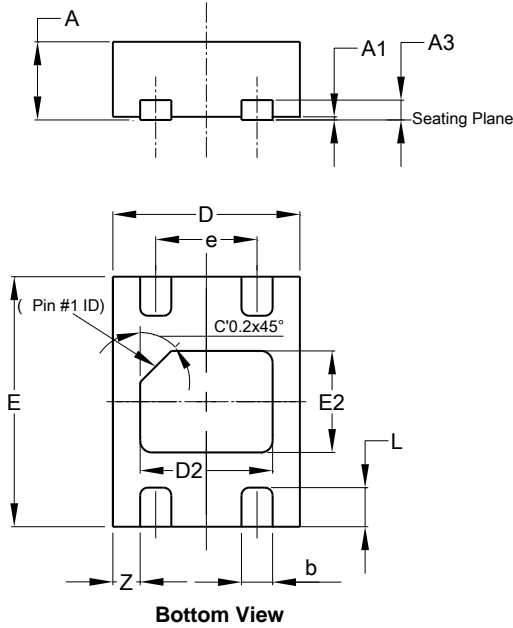

X1-DFN1216-4			
Dim	Min	Max	Typ
A	0.47	0.53	0.50
A1	0.00	0.05	0.02
A3	--	--	0.13
b	0.15	0.25	0.20
D	1.15	1.25	1.20
D2	0.75	0.95	0.85
E	1.55	1.65	1.60
E2	0.55	0.75	0.65
e	-	-	0.65
L	0.20	0.30	0.25
Z	-	-	0.175
All Dimensions in mm			

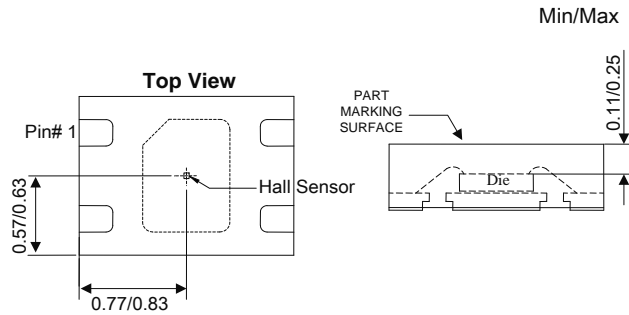

**Sensor Location**

**Package Outline Dimensions** (continued) (All dimensions in mm.)

Please see <http://www.diodes.com/package-outlines.html> for the latest version.

(2) Package Type: X2-DFN2015-6

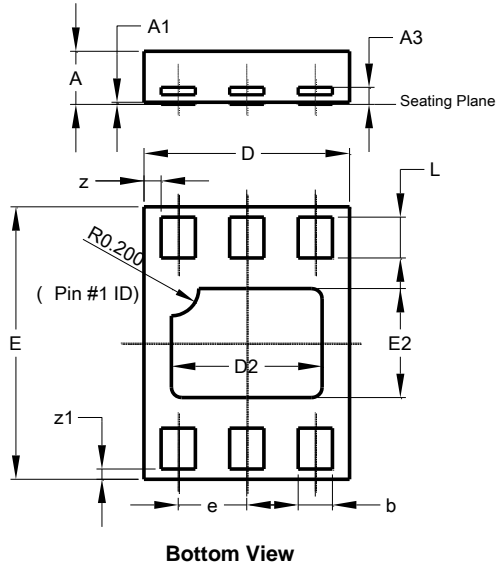

X2-DFN2015-6			
Dim	Min	Max	Typ
A	0.375	0.40	0.390
A1	0	0.05	0.02
A3	-	-	0.13
b	0.20	0.30	0.25
D	1.45	1.575	1.50
D2	1.00	1.20	1.10
e	-	-	0.50
E	1.95	2.075	2.00
E2	0.70	0.90	0.80
L	0.25	0.35	0.30
Z	-	-	0.125
Z1	-	-	0.075
<b>All Dimensions in mm</b>			

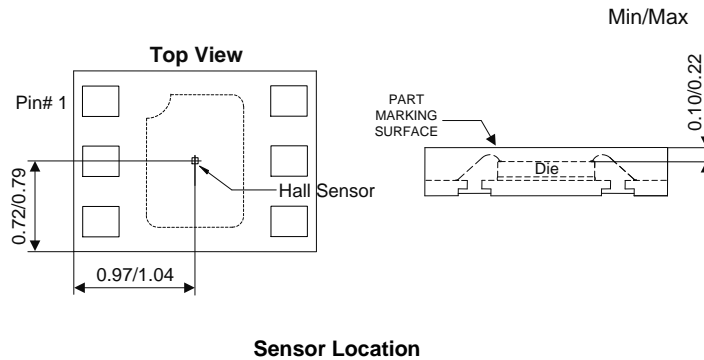



**Package Outline Dimensions** (cont.) (All dimensions in mm.)

Please see <http://www.diodes.com/package-outlines.html> for the latest version.

(3) Package Type: SOT553

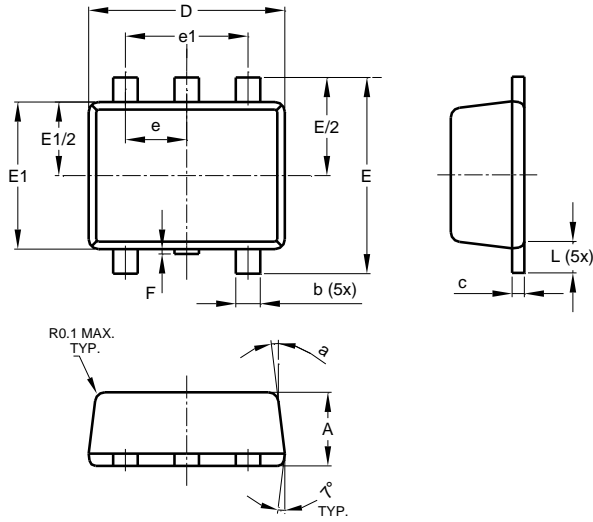

SOT553			
Dim	Min	Max	Typ
A	0.55	0.62	0.60
b	0.15	0.30	0.20
c	0.10	0.18	0.15
D	1.50	1.70	1.60
E	1.55	1.70	1.60
E1	1.10	1.25	1.20
e	0.50 BSC		
e1	1.00 BSC		
F	0.00	0.10	—
L	0.10	0.30	0.20
a	6°	8°	7°
<b>All Dimensions in mm</b>			

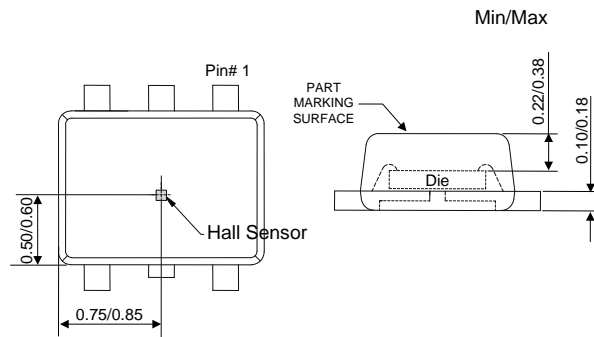

**Sensor Location**

## Suggested Pad Layout

Please see <http://www.diodes.com/package-outlines.html> for the latest version.

### (1) Package Type: X1-DFN1216-4

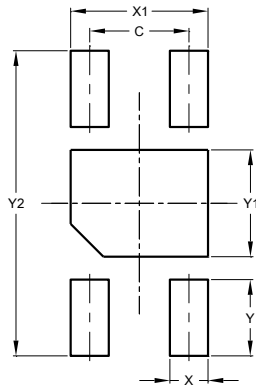

X1-DFN1216-4	
Dimensions	Value
C	0.65
X	0.25
X1	0.90
Y	0.50
Y1	0.70
Y2	2.00
All Dimensions in mm	

### (2) Package Type: X2-DFN2015-6

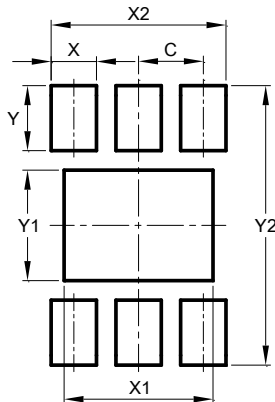

X2-DFN2015-6	
Dimensions	Value
C	0.500
X	0.350
X1	1.150
X2	1.350
Y	0.500
Y1	0.850
Y2	2.150
All Dimensions in mm	

### (3) Package Type: SOT553

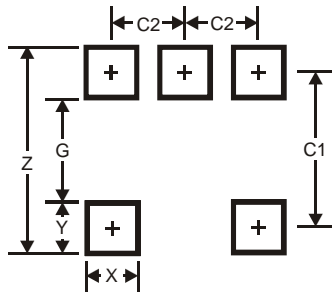

SOT553	
Dimensions	Value
Z	2.2
G	1.2
X	0.375
Y	0.5
C1	1.7
C2	0.5
All Dimensions in mm	

**IMPORTANT NOTICE**

DIODES INCORPORATED MAKES NO WARRANTY OF ANY KIND, EXPRESS OR IMPLIED, WITH REGARDS TO THIS DOCUMENT, INCLUDING, BUT NOT LIMITED TO, THE IMPLIED WARRANTIES OF MERCHANTABILITY AND FITNESS FOR A PARTICULAR PURPOSE (AND THEIR EQUIVALENTS UNDER THE LAWS OF ANY JURISDICTION).

Diodes Incorporated and its subsidiaries reserve the right to make modifications, enhancements, improvements, corrections or other changes without further notice to this document and any product described herein. Diodes Incorporated does not assume any liability arising out of the application or use of this document or any product described herein; neither does Diodes Incorporated convey any license under its patent or trademark rights, nor the rights of others. Any Customer or user of this document or products described herein in such applications shall assume all risks of such use and will agree to hold Diodes Incorporated and all the companies whose products are represented on Diodes Incorporated website, harmless against all damages.

Diodes Incorporated does not warrant or accept any liability whatsoever in respect of any products purchased through unauthorized sales channel. Should Customers purchase or use Diodes Incorporated products for any unintended or unauthorized application, Customers shall indemnify and hold Diodes Incorporated and its representatives harmless against all claims, damages, expenses, and attorney fees arising out of, directly or indirectly, any claim of personal injury or death associated with such unintended or unauthorized application.

Products described herein may be covered by one or more United States, international or foreign patents pending. Product names and markings noted herein may also be covered by one or more United States, international or foreign trademarks.

This document is written in English but may be translated into multiple languages for reference. Only the English version of this document is the final and determinative format released by Diodes Incorporated.

**LIFE SUPPORT**

Diodes Incorporated products are specifically not authorized for use as critical components in life support devices or systems without the express written approval of the Chief Executive Officer of Diodes Incorporated. As used herein:

A. Life support devices or systems are devices or systems which:

1. are intended to implant into the body, or
2. support or sustain life and whose failure to perform when properly used in accordance with instructions for use provided in the labeling can be reasonably expected to result in significant injury to the user.

B. A critical component is any component in a life support device or system whose failure to perform can be reasonably expected to cause the failure of the life support device or to affect its safety or effectiveness.

Customers represent that they have all necessary expertise in the safety and regulatory ramifications of their life support devices or systems, and acknowledge and agree that they are solely responsible for all legal, regulatory and safety-related requirements concerning their products and any use of Diodes Incorporated products in such safety-critical, life support devices or systems, notwithstanding any devices- or systems-related information or support that may be provided by Diodes Incorporated. Further, Customers must fully indemnify Diodes Incorporated and its representatives against any damages arising out of the use of Diodes Incorporated products in such safety-critical, life support devices or systems.

Copyright © 2016, Diodes Incorporated

[www.diodes.com](http://www.diodes.com)

Компания «Океан Электроники» предлагает заключение долгосрочных отношений при поставках импортных электронных компонентов на взаимовыгодных условиях!

Наши преимущества:

- Поставка оригинальных импортных электронных компонентов напрямую с производств Америки, Европы и Азии, а так же с крупнейших складов мира;
- Широкая линейка поставок активных и пассивных импортных электронных компонентов (более 30 млн. наименований);
- Поставка сложных, дефицитных, либо снятых с производства позиций;
- Оперативные сроки поставки под заказ (от 5 рабочих дней);
- Экспресс доставка в любую точку России;
- Помощь Конструкторского Отдела и консультации квалифицированных инженеров;
- Техническая поддержка проекта, помощь в подборе аналогов, поставка прототипов;
- Поставка электронных компонентов под контролем ВП;
- Система менеджмента качества сертифицирована по Международному стандарту ISO 9001;
- При необходимости вся продукция военного и аэрокосмического назначения проходит испытания и сертификацию в лаборатории (по согласованию с заказчиком);
- Поставка специализированных компонентов военного и аэрокосмического уровня качества (Xilinx, Altera, Analog Devices, Intersil, Interpoint, Microsemi, Actel, Aeroflex, Peregrine, VPT, Syfer, Eurofarad, Texas Instruments, MS Kennedy, Miteq, Cobham, E2V, MA-COM, Hittite, Mini-Circuits, General Dynamics и др.);

Компания «Океан Электроники» является официальным дистрибьютором и эксклюзивным представителем в России одного из крупнейших производителей разъемов военного и аэрокосмического назначения «JONHON», а так же официальным дистрибьютором и эксклюзивным представителем в России производителя высокотехнологичных и надежных решений для передачи СВЧ сигналов «FORSTAR».



## JONHON

«JONHON» (основан в 1970 г.)

Разъемы специального, военного и аэрокосмического назначения:

(Применяются в военной, авиационной, аэрокосмической, морской, железнодорожной, горно- и нефтедобывающей отраслях промышленности)

«FORSTAR» (основан в 1998 г.)

ВЧ соединители, коаксиальные кабели, кабельные сборки и микроволновые компоненты:

(Применяются в телекоммуникациях гражданского и специального назначения, в средствах связи, РЛС, а так же военной, авиационной и аэрокосмической отраслях промышленности).



Телефон: 8 (812) 309-75-97 (многоканальный)

Факс: 8 (812) 320-03-32

Электронная почта: [ocean@oceanchips.ru](mailto:ocean@oceanchips.ru)

Web: <http://oceanchips.ru/>

Адрес: 198099, г. Санкт-Петербург, ул. Калинина, д. 2, корп. 4, лит. А