

## Compact, General-purpose Horizontal Switches.



### Models for Microloads Added to Series

- Approved by EN, UL, CSA, and CCC (Chinese standard). (Ask your OMRON representative for information on approved models.)
- Incorporates a switch with a durable coil spring in a tough, high-precision case.
- Compact and uses a single basic switch for applications where strength is required.
- Models for microloads and models with operation indicators added to series.
- Terminal protective cover can be switched to wire cable from either the left or right.
- Sealing characteristics that meet IEC IP67 degree of protection.



For the most recent information on models that have been certified for safety standards, refer to your OMRON website.

Be sure to read *Safety Precautions* on page 7 and *Safety Precautions for All Limit Switches*.

## Ordering Information

### Switches

Actuator	Type	Standard	Micro load
		Model	Model
Plunger		SHL-D55	SHL-D55-01
Panel mount plunger		SHL-Q55	SHL-Q55-01
Panel mount roller plunger		SHL-Q2255	SHL-Q2255-01
Panel mount crossroller plunger		SHL-Q2155	SHL-Q2155-01
Short hinge lever		SHL-W55	SHL-W55-01
Hinge lever		SHL-W155	SHL-W155-01

Actuator	Type	Standard	Micro load
		Model	Model
Short hinge roller lever		SHL-W255	SHL-W255-01
Hinge roller lever		SHL-W2155	SHL-W2155-01
One-way action short hinge roller lever		SHL-W355	SHL-W355-01
One-way action hinge roller lever		SHL-W3155	SHL-W3155-01

Note: Models are also available with molded terminals and with molded terminals and operation indicators. Refer to page 6.

### Switches (Molded Terminal Models)

#### Without Operation Indicator, Lead Wired on Right

Standard		Micro load	
Model	Model	Model	Model
SHL-D55-MR SHL-Q55-MR SHL-Q2155-MR SHL-Q2255-MR SHL-W55-MR	SHL-W155-MR SHL-W255-MR SHL-W2155-MR SHL-W355-MR	SHL-D55-01MR SHL-Q55-01MR SHL-Q2155-01MR SHL-Q2255-01MR SHL-W55-01MR	SHL-W255-01MR SHL-W2155-01MR

#### Without Operation Indicator, Lead Wired on Left

Standard		Micro load
Model	Model	Model
SHL-D55-ML SHL-Q2155-ML SHL-Q2255-ML SHL-W55-ML SHL-W155-ML	SHL-W255-ML SHL-W2155-ML	SHL-Q2255-01ML SHL-W2155-01ML

## Without Operation Indicator, Lead Wired from Bottom

Standard		Micro load
Model	Model	Model
SHL-D55-MD SHL-Q55-MD SHL-Q2155-MD SHL-Q2255-MD SHL-W55-MD	SHL-W155-MD SHL-W255-MD SHL-W2155-MD SHL-W355-MD	SHL-Q2255-01MD

## Operation Indicator, Lead Wired on Right

Standard		Micro load
Model	Model	Model
SHL-D55-LMR SHL-Q55-LMR SHL-Q2155-LMR SHL-Q2255-LMR SHL-W155-LMR SHL-W255-LMR SHL-W2155-LMR SHL-D55-L2MR SHL-Q2255-L2MR SHL-D55-L3MR SHL-Q55-L3MR SHL-Q2155-L3MR	SHL-Q2255-L3MR SHL-W155-L3MR SHL-W255-L3MR SHL-W2155-L3MR SHL-D55-L4MR SHL-Q55-L4MR SHL-Q2155-L4MR SHL-Q2255-L4MR SHL-W255-L4MR SHL-W2155-L4MR SHL-W355-L4MR	SHL-Q2255-01LMR SHL-W255-01LMR SHL-D55-01L3MR SHL-Q2155-01L3MR SHL-Q2255-01L3MR SHL-Q2155-01L4MR SHL-Q2255-01L4MR SHL-W255-01L4MR SHL-W2155-01L4MR

## Operation Indicator, Lead Wired on Left

Standard		Micro load
Model	Model	Model
SHL-Q55-LML SHL-Q2255-LML SHL-W155-LML SHL-W255-LML SHL-W2155-LML SHL-Q55-L2ML SHL-Q2255-L3ML	SHL-W55-L3ML SHL-W155-L3ML SHL-W255-L3ML SHL-Q2255-L4ML SHL-W155-L4ML	SHL-W255-01LML SHL-W2155-01LML SHL-Q2255-01L3ML SHL-W255-01L4ML

## Operation Indicator, Lead Wired from Bottom

Standard		Micro load
Model	Model	Model
SHL-Q2255-LMD SHL-W255-LMD SHL-Q55-L3MD	SHL-Q2255-L4MD SHL-W255-L4MD SHL-W2155-L4MD	SHL-Q55-01LMD SHL-Q2255-01L4MD

## Specifications

## Approved Standards

Agency	Standard	File No.	Approved models
UL	UL508	E76675	General-purpose models listed on page 1.
CSA	CSA C22.2 No. 14	LR45746	
TÜV Rheinland	EN60947-5-1	J50062486	All SHL models listed in this datasheet.
CCC (CQC)	GB14048.5	2003010305072162	Ask your OMRON representative for information on approved models.

**Ratings**

Rated voltage	Non-inductive load (A)				Inductive load (A)			
	Resistive load		Lamp load		Inductive load		Motor load	
	NC	NO	NC	NO	NC	NO	NC	NO
125 VAC	10		1.5		3		2.5	
250 VAC	10		1.5		2		1.5	
480 VAC	2		–		–		–	
8 VDC	10		2		5		2	
14 VDC	10		2		5		2	
30 VDC	5		1.5		1.5		1.5	
125 VDC	0.4		0.4		0.05		0.05	
250 VDC	0.2		0.2		0.03		0.03	

Inrush current	NC	15 A max.
	NO	15 A max.

- Note: 1. The above figures are for steady-state currents.  
 2. Inductive loads have a power factor of 0.4 min. (AC) and a time constant of 7 ms max. (DC).  
 3. Lamp load has an inrush current of 10 times the steady-state current.  
 4. Motor load has an inrush current of 6 times the steady-state current.

**Micro load models**

Rated voltage	Non-inductive load (A)	
	Resistive load	
	NC	NO
125 VAC	0.1	
8 VDC	0.1	
14 VDC	0.1	
30 VDC	0.1	

**Approved Standard Ratings  
TÜV (EN60947-5-1), CCC (GB14048.5)**

Model	Category and rating	I the
SHL-□55	AC-15 2 A/125 V DC-12 2 A/48 V	5 A 5 A
SHL-□55-01	AC-14 0.1 A/125 V DC-12 0.1 A/48 V	0.5 A 0.5 A
SHL-□55-L	AC-15 2 A/125 V	5 A
SHL-□55-01L	AC-14 0.1 A/125 V	0.5 A
SHL-□55-01L2	DC-12 0.1 A/12 V	0.5 A
SHL-□55-L3	DC-12 2 A/24 V	5 A
SHL-□55-01L3	DC-12 0.1 A/24 V	0.5 A
SHL-□55-L4	DC-12 2 A/24 V	5 A
SHL-□55-01L4	DC-12 0.1 A/24 V	0.5 A
SHL-□55-L5	DC-12 2 A/48 V	5 A
SHL-□55-01L5	DC-12 0.1 A/48 V	0.5 A

Note: "AC-15 2 A/125 V" indicates the following.  
 Application category: AC-16  
 Rated operating current (Ie): 2 A  
 Rated operating voltage (Ue): 125 V

**UL/CSA  
A300**

Rated voltage	Carry current	Current (A)		Volt-amperes (V)	
		Make	Break	Make	Break
120 VAC 240 VAC	10 A	60 30	6 3	7,200	720

**Characteristics (For SHL-W155)**

Degree of protections	IP67 (EN60947-5-1)	
Durability	Mechanical	10,000,000 operations min.
	Electrical	500,000 operations min.
Operating speed	0.1 mm/s to 0.5 m/s (hinge lever models)	
Operating frequency	Mechanical	120 operations/min
	Electrical	30 operations/min
Rated frequency	50/60 Hz	
Insulation resistance	100 MΩ min. (at 500 VDC)	
Contact resistance	15 mΩ max. (initial value for the built-in switch when tested alone)	
Dielectric strength	Between terminals of the same polarity	1,000 VAC, 50/60 Hz for 1 min
	Between each terminal and non-current-carrying metal part	2,000 VAC, 50/60 Hz for 1 min/Uimp at 2.5 kV (EN60947-5-1)
Rated insulation voltage (Ui)	150 V (EN60947-5-1)	
Pollution degree (operating environment)	3 (EN60947-5-1)	
Short-circuit protective device (SCPD)	10 A fuse type gI or gG (IEC60269)	
Conditional short-circuit current	100 A (EN60947-5-1)	
Conventional enclosed thermal current (Ithe)	5 A (EN60947-5-1)	
Protection against electric shock	Class II (grounding not required with double insulation)	
OFF reverse voltage	1,000 VAC max., 300 VDC max. (EN60947-5-1)	
Vibration resistance	Malfunction	10 to 55 Hz, 1.5-mm double amplitude
Shock resistance	Destruction	1,000 m/s <sup>2</sup> max.
	Malfunction	300 m/s <sup>2</sup> max.
Ambient operating temperature	-10°C to +80°C (with no icing)	
Ambient operating humidity	35% to 95%RH	
Weight	Approx. 62 to 72 g	

**Engineering Data  
Electrical Durability**

(Ambient temperature: +5°C to +35°C,  
 Ambient humidity: 40% to 50%RH)

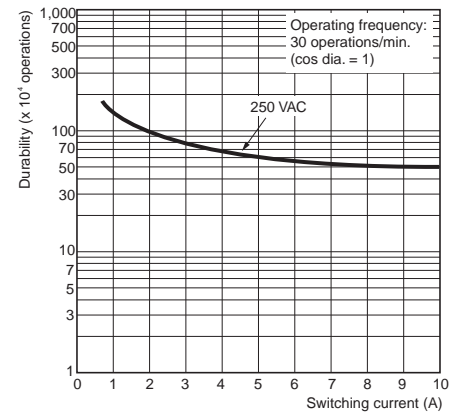

- Note: 1. The figures at the left are initial values.  
 2. The ratings at the left may vary depending on the model. Contact your OMRON representative for further details.  
 \*1. The head section of the plunger type SHL-D(Q)□□ is excluded.  
 \*2. Durability values are calculated at an operating temperature of +5°C to +35°C, and an operating humidity of 40% to 70%RH.  
 \*3. The values are for the plunger-type models.

**Structure and Nomenclature**

**Structure**



**Contact Form**



## Dimensions and Operating Characteristics

**Switches** (Note: Omitted dimensions are the same as those of the plunger models.)

### Plunger SHL-D55 SHL-D55-01



Operating Characteristics		Model	SHL-D55 SHL-D55-01
Operating force	OF	max.	9.81 N
Release force	RF	min.	1.96 N
Pretravel	PT	max.	1.5 mm
Overtravel	OT	min.	2 mm
Movement Differential	MD	max.	0.5 mm
Free Position	FP	max.	-
Operating Position	OP		34±0.8 mm

### Panel Mount Plunger SHL-Q55 SHL-Q55-01



Operating Characteristics		Model	SHL-Q55 SHL-Q55-01
OF	max.		9.81 N
RF	min.		1.96 N
PT	max.		1.5 mm
OT	min.		2 mm
MD	max.		0.5 mm
FP	max.		-
OP			34±0.8 mm

### Panel Mount Roller Plunger SHL-Q2255 SHL-Q2255-01

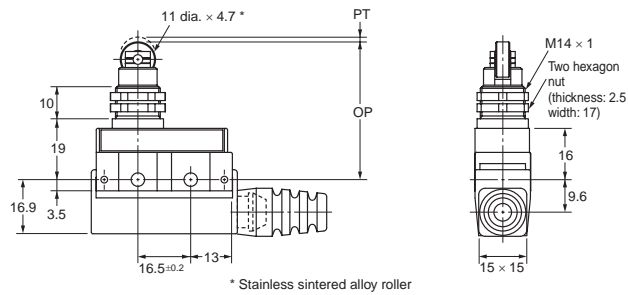
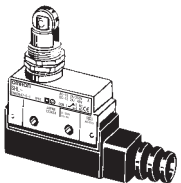

Operating Characteristics		Model	SHL-Q2255 SHL-Q2255-01
OF	max.		9.81 N
RF	min.		1.96 N
PT	max.		1.5 mm
OT	min.		2 mm
MD	max.		0.5 mm
FP	max.		-
OP			43±0.8 mm

### Panel Mount Crossroller Plunger SHL-Q2155 SHL-Q2155-01



Operating Characteristics		Model	SHL-Q2155 SHL-Q2155-01
OF	max.		9.81 N
RF	min.		1.96 N
PT	max.		1.5 mm
OT	min.		2 mm
MD	max.		0.5 mm
FP	max.		-
OP			43±0.8 mm

### Short Hinge Lever SHL-W55 SHL-W55-01



Operating Characteristics		Model	SHL-W55 SHL-W55-01
OF	max.		3.14 N
RF	min.		0.78 N
PT	max.		8 mm
OT	min.		3 mm
MD	max.		2.5 mm
FP	max.		29.5 mm
OP			21.5±1 mm

Note: Unless otherwise specified, a tolerance of ±0.4 mm applies to all dimensions.

**Hinge Lever**  
**SHL-W155**  
**SHL-W155-01**



Operating Characteristics		Model	SHL-W155-01
OF	max.		2.35 N
RF	min.		0.44 N
PT	max.		13 mm
OT	min.		5 mm
MD	max.		4 mm
FP	max.		34.5 mm
OP			21.5±1 mm

**Short Hinge Roller Lever**  
**SHL-W255**  
**SHL-W255-01**



Operating Characteristics		Model	SHL-W255-01
OF	max.		3.92 N
RF	min.		0.78 N
PT	max.		8 mm
OT	min.		3 mm
MD	max.		2.5 mm
FP	max.		41 mm
OP			33±1 mm

**Hinge Roller Lever**  
**SHL-W2155**  
**SHL-W2155-01**



Operating Characteristics		Model	SHL-W2155-01
OF	max.		2.55 N
RF	min.		0.49 N
PT	max.		13 mm
OT	min.		5.5 mm
MD	max.		4 mm
FP	max.		46.5 mm
OP			33.5±1 mm

**One-way Action Short Hinge Roller Lever**  
**SHL-W355**  
**SHL-W355-01**



Operating Characteristics		Model	SHL-W355-01
OF	max.		3.92 N
RF	min.		0.78 N
PT	max.		8 mm
OT	min.		3 mm
MD	max.		2.5 mm
FP	max.		52.5 mm
OP			44.5±1 mm

**One-way Action Hinge Roller Lever**  
**SHL-W3155**  
**SHL-W3155-01**



Operating Characteristics		Model	SHL-W3155-01
OF	max.		2.55 N
RF	min.		0.49 N
PT	max.		13 mm
OT	min.		5.5 mm
MD	max.		4 mm
FP	max.		57.5 mm
OP			44.5±1 mm

Note: Unless otherwise specified, a tolerance of ±0.4 mm applies to all dimensions.

### Molded Terminal Models

Use of the molded terminal model is recommended in locations subject to excessive dust, oil drips, or moisture. All types of SHL Switches can be fabricated into a molded terminal version. In this case, the molded terminal model will have the same dimensions and operating characteristics as the basic model from which the molded terminal model is fabricated.



#### Suffix by Location of Lead Outlet

Location of lead outlet (Refer to left figure)	Model (suffix)	
	Terminal	COM, NC, NO
Right-hand	-MR	
Left-hand	-ML	
Underside	-MD	

Note: The above suffixes can be added to the model numbers given on page 1 to specify molded terminals.

#### How to order

##### Example:

Basic type: SHL-Q2255  
 Location of lead outlet: Right side  
 Length of lead: 3 m (V.C.T.F. lead)  
 When placing your order for the above Switch specify the model number as SHL-Q2255-MR VCTF 3M.

#### Lead Supplies

Leads	Specifications	VCTF (Vinyl cabtire cable)
Nominal cross-sectional area (mm <sup>2</sup> )		0.75
No. of conductors/cond. dia.		30/0.18
External diameter (mm)		3-conductor 7 dia.
Terminal connections		Black: COM White: NO Red: NC
Length (m)		3 (standard)

### Operation Indicator-equipped Models

The molded terminal model may be equipped with an operation indicator (neon lamp or LED) upon request to facilitate maintenance and inspection.

The operation indicator is designed to illuminate when the Switch is not operating. (Because of the molded terminal model, any change to the Switch wiring cannot be made.)

Note: Refer to the previous table for model numbers for Switch with molded terminals and operation indicators.

#### For AC

- The applicable voltage is 90 to 250 VAC (microload models: 90 to 125 VAC).

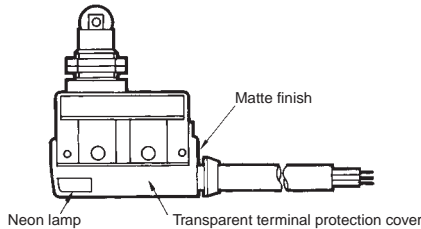

- Operating characteristics are the same as the basic model from which the operation indicator equipped model is fabricated.
- Dimension are the same as the standard model.

#### Example:

Basic type: SHL-Q2255-MR  
 When placing your order for the molded terminal model with an neon lamp operation indicator, specify the model number as SHL-Q2255-LMR.

#### Contact Circuit

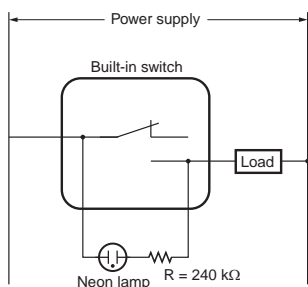

#### For DC

- LED indicator is provided.
- As a rectifier stack is incorporated, into the unit and no directionality exists for connection of + and -, this type can also be operated on AC.
- The voltage specifications are given below.
- Voltage ratings of LED indicators are as shown in the table below.

Model	Voltage rating (V)	Leakage current (mA)	Internal resistance (kΩ)
L2	12	Approx. 2.4	4.3
L3	24	Approx. 2	10
L4	24	Approx. 1.2	18

#### Example:

Basic type: SHL-Q2255-MR  
 When placing your order for the molded terminal with an LED indicator rated at 12 V, specify the model number as SHL-Q2255-L2MR.

#### Contact Circuit

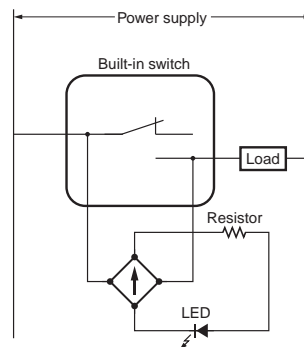

## Safety Precautions

Refer to *Safety Precautions for All Limit Switches*.

### Precautions for Correct Use

#### Operating Environment

- Seal material may deteriorate if a Switch is used outdoor or where subject to special cutting oils, solvents, or chemicals. Always appraise performance under actual application conditions and set suitable maintenance and replacement periods.
- Install Switches where they will not be directly subject to cutting chips, dust, or dirt. The Actuator and Switch must also be protected from the accumulation of cutting chips or sludge.

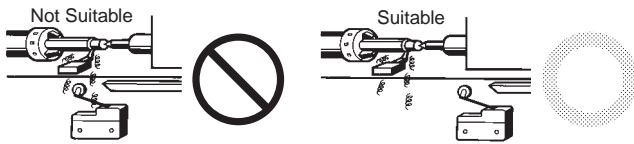

- Constantly subjecting a Switch to vibration or shock can result in wear, which can lead to contact interference with contacts, operation failure, reduced durability, and other problems. Excessive vibration or shock can lead to false contact operation or damage. Install Switches in locations not subject to shock and vibration and in orientations that will not produce resonance.
- The Switches have physical contacts. Using them in environments containing silicon gas will result in the formation of silicon oxide ( $\text{SiO}_2$ ) due to arc energy. If silicon oxide accumulates on the contacts, contact interference can occur. If silicon oil, silicon filling agents, silicon cables, or other silicon products are present near the Switch, suppress arcing with contact protective circuits (surge killers) or remove the source of silicon gas.

#### Connections

Be sure to connect a fuse with a breaking current 1.5 to 2 times the rated current to the Limit Switch in series in order to protect the Limit Switch from damage due to short-circuiting. When using the Limit Switch under the EN ratings, use a gl or gG 10-A fuse that conforms to IEC60269.

#### Mounting

- Secure the Switch with two M4 screws and washers. The tightening torque applied to each terminal must be 1.18 to 1.37 N·m. Tighten the screws to the specified torque. An excessive tightening torque may damage the Switch and cause a malfunction.
- When mounting the panel mount-type Switch with screws on a side surface, remove the hexagonal nuts from the actuator.

##### Mounting Holes

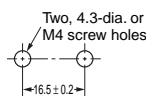

- When mounting the panel mount type (SHL-Q55, SHL-Q2255, or SHL-Q2155) on a panel, tighten the hexagonal nuts of the actuator to a torque less than 4.90 to 7.84 N·m.

##### Mounting Holes



#### Micro Load Models

When using a Limit Switch for opening or closing micro-load circuit (zones 1 through 3), contact failure may occur if a Limit Switch with ordinary contact specifications is used. Therefore, when using Limit Switches in the micro-load range, use ones with contact specifications that are suited to each zone. Use the SHL-□-01 micro load models within the zones (1 through 3) shown in the following diagram.

##### Micro Load Applicable Ranges



The above diagram is for standard conditions (+5°C to +35°C, 40% to 70%RH). Since the values vary depending on the operating environment conditions, contact your OMRON representative for further details.

#### Tightening Torque

- A loose screw may result in a malfunction. Be sure to tighten each screw to the proper tightening torque as shown below.

No.	Type	Appropriate tightening torque
1	Terminal screw (M3 screw)	0.24 to 0.44 N·m
2	Mounting screw (M4 screw)	1.18 to 1.37 N·m

- When wiring, use M3 round solderless terminals and apply insulation shielding to the connections. Tighten the terminals screws to 0.24 to 0.44 N·m.

#### Operating Stroke

Ensure that the operating stroke for roller plunger models is within the set position display.



#### Others

The standard seal rubber for the lead wire outlet is one that allows 6- to 8-dia. cables. The appropriate nominal cross-section of the lead wire is 0.75 mm<sup>2</sup>. (When the sealing capability is required over a long period of time, use mold specifications.)



## Terms and Conditions Agreement

### Read and understand this catalog.

Please read and understand this catalog before purchasing the products. Please consult your OMRON representative if you have any questions or comments.

### Warranties.

(a) Exclusive Warranty. Omron's exclusive warranty is that the Products will be free from defects in materials and workmanship for a period of twelve months from the date of sale by Omron (or such other period expressed in writing by Omron). Omron disclaims all other warranties, express or implied.

(b) Limitations. OMRON MAKES NO WARRANTY OR REPRESENTATION, EXPRESS OR IMPLIED, ABOUT NON-INFRINGEMENT, MERCHANTABILITY OR FITNESS FOR A PARTICULAR PURPOSE OF THE PRODUCTS. BUYER ACKNOWLEDGES THAT IT ALONE HAS DETERMINED THAT THE PRODUCTS WILL SUITABLY MEET THE REQUIREMENTS OF THEIR INTENDED USE.

Omron further disclaims all warranties and responsibility of any type for claims or expenses based on infringement by the Products or otherwise of any intellectual property right. (c) Buyer Remedy. Omron's sole obligation hereunder shall be, at Omron's election, to (i) replace (in the form originally shipped with Buyer responsible for labor charges for removal or replacement thereof) the non-complying Product, (ii) repair the non-complying Product, or (iii) repay or credit Buyer an amount equal to the purchase price of the non-complying Product; provided that in no event shall Omron be responsible for warranty, repair, indemnity or any other claims or expenses regarding the Products unless Omron's analysis confirms that the Products were properly handled, stored, installed and maintained and not subject to contamination, abuse, misuse or inappropriate modification. Return of any Products by Buyer must be approved in writing by Omron before shipment. Omron Companies shall not be liable for the suitability or unsuitability or the results from the use of Products in combination with any electrical or electronic components, circuits, system assemblies or any other materials or substances or environments. Any advice, recommendations or information given orally or in writing, are not to be construed as an amendment or addition to the above warranty.

See <http://www.omron.com/global/> or contact your Omron representative for published information.

### Limitation on Liability; Etc.

OMRON COMPANIES SHALL NOT BE LIABLE FOR SPECIAL, INDIRECT, INCIDENTAL, OR CONSEQUENTIAL DAMAGES, LOSS OF PROFITS OR PRODUCTION OR COMMERCIAL LOSS IN ANY WAY CONNECTED WITH THE PRODUCTS, WHETHER SUCH CLAIM IS BASED IN CONTRACT, WARRANTY, NEGLIGENCE OR STRICT LIABILITY.

Further, in no event shall liability of Omron Companies exceed the individual price of the Product on which liability is asserted.

### Suitability of Use.

Omron Companies shall not be responsible for conformity with any standards, codes or regulations which apply to the combination of the Product in the Buyer's application or use of the Product. At Buyer's request, Omron will provide applicable third party certification documents identifying ratings and limitations of use which apply to the Product. This information by itself is not sufficient for a complete determination of the suitability of the Product in combination with the end product, machine, system, or other application or use. Buyer shall be solely responsible for determining appropriateness of the particular Product with respect to Buyer's application, product or system. Buyer shall take application responsibility in all cases.

NEVER USE THE PRODUCT FOR AN APPLICATION INVOLVING SERIOUS RISK TO LIFE OR PROPERTY OR IN LARGE QUANTITIES WITHOUT ENSURING THAT THE SYSTEM AS A WHOLE HAS BEEN DESIGNED TO ADDRESS THE RISKS, AND THAT THE OMRON PRODUCT(S) IS PROPERLY RATED AND INSTALLED FOR THE INTENDED USE WITHIN THE OVERALL EQUIPMENT OR SYSTEM.

### Programmable Products.

Omron Companies shall not be responsible for the user's programming of a programmable Product, or any consequence thereof.

### Performance Data.

Data presented in Omron Company websites, catalogs and other materials is provided as a guide for the user in determining suitability and does not constitute a warranty. It may represent the result of Omron's test conditions, and the user must correlate it to actual application requirements. Actual performance is subject to the Omron's Warranty and Limitations of Liability.

### Change in Specifications.

Product specifications and accessories may be changed at any time based on improvements and other reasons. It is our practice to change part numbers when published ratings or features are changed, or when significant construction changes are made. However, some specifications of the Product may be changed without any notice. When in doubt, special part numbers may be assigned to fix or establish key specifications for your application. Please consult with your Omron's representative at any time to confirm actual specifications of purchased Product.

### Errors and Omissions.

Information presented by Omron Companies has been checked and is believed to be accurate; however, no responsibility is assumed for clerical, typographical or proofreading errors or omissions.



Компания «Океан Электроники» предлагает заключение долгосрочных отношений при поставках импортных электронных компонентов на взаимовыгодных условиях!

Наши преимущества:

- Поставка оригинальных импортных электронных компонентов напрямую с производств Америки, Европы и Азии, а так же с крупнейших складов мира;
- Широкая линейка поставок активных и пассивных импортных электронных компонентов (более 30 млн. наименований);
- Поставка сложных, дефицитных, либо снятых с производства позиций;
- Оперативные сроки поставки под заказ (от 5 рабочих дней);
- Экспресс доставка в любую точку России;
- Помощь Конструкторского Отдела и консультации квалифицированных инженеров;
- Техническая поддержка проекта, помощь в подборе аналогов, поставка прототипов;
- Поставка электронных компонентов под контролем ВП;
- Система менеджмента качества сертифицирована по Международному стандарту ISO 9001;
- При необходимости вся продукция военного и аэрокосмического назначения проходит испытания и сертификацию в лаборатории (по согласованию с заказчиком);
- Поставка специализированных компонентов военного и аэрокосмического уровня качества (Xilinx, Altera, Analog Devices, Intersil, Interpoint, Microsemi, Actel, Aeroflex, Peregrine, VPT, Syfer, Eurofarad, Texas Instruments, MS Kennedy, Miteq, Cobham, E2V, MA-COM, Hittite, Mini-Circuits, General Dynamics и др.);

Компания «Океан Электроники» является официальным дистрибьютором и эксклюзивным представителем в России одного из крупнейших производителей разъемов военного и аэрокосмического назначения «JONHON», а так же официальным дистрибьютором и эксклюзивным представителем в России производителя высокотехнологичных и надежных решений для передачи СВЧ сигналов «FORSTAR».



## JONHON

«JONHON» (основан в 1970 г.)

Разъемы специального, военного и аэрокосмического назначения:

(Применяются в военной, авиационной, аэрокосмической, морской, железнодорожной, горно- и нефтедобывающей отраслях промышленности)

«FORSTAR» (основан в 1998 г.)

ВЧ соединители, коаксиальные кабели,  
кабельные сборки и микроволновые компоненты:

(Применяются в телекоммуникациях гражданского и специального назначения, в средствах связи, РЛС, а так же военной, авиационной и аэрокосмической отраслях промышленности).



Телефон: 8 (812) 309-75-97 (многоканальный)

Факс: 8 (812) 320-03-32

Электронная почта: [ocean@oceanchips.ru](mailto:ocean@oceanchips.ru)

Web: <http://oceanchips.ru/>

Адрес: 198099, г. Санкт-Петербург, ул. Калинина, д. 2, корп. 4, лит. А