



SANYO Semiconductors

DATA SHEET

An ON Semiconductor Company

2SC5226A — NPN Epitaxial Planar Silicon Transistor VHF to UHF Wide-Band Low-Noise Amplifier Applications

Features

- Low-noise : NF=1.0dB typ (f=1GHz)
- High gain : $|S_{21e}|^2=12\text{dB typ (f=1GHz)}$
- High cut-off frequency : $f_T=7\text{GHz typ}$

Specifications

Absolute Maximum Ratings at Ta=25°C

Parameter	Symbol	Conditions	Ratings	Unit
Collector-to-Base Voltage	V _{CBO}		20	V
Collector-to-Emitter Voltage	V _{CEO}		10	V
Emitter-to-Base Voltage	V _{EBO}		2	V
Collector Current	I _C		70	mA
Collector Dissipation	P _C		150	mW
Junction Temperature	T _j		150	°C
Storage Temperature	T _{stg}		-55 to +150	°C

Package Dimensions

unit : mm (typ)

7023A-009

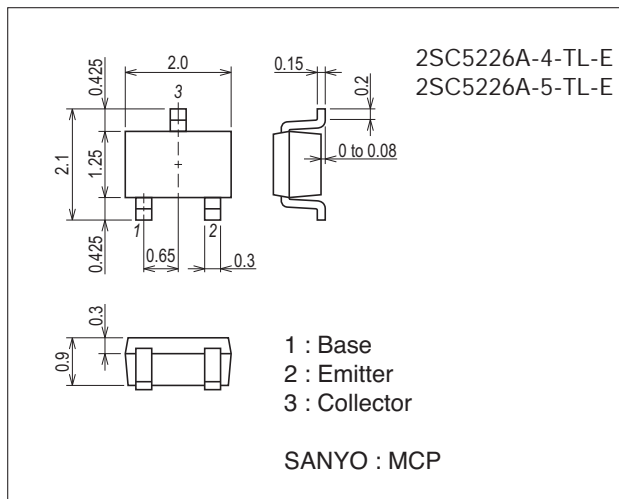

Product & Package Information

- Package : MCP
- JEITA, JEDEC : SC-70, SOT-323
- Minimum Packing Quantity : 3,000 pcs./reel

Packing Type: TL

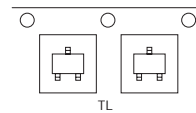

Marking

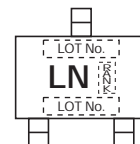

Electrical Connection

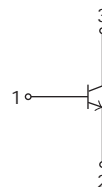

2SC5226A

Electrical Characteristics at Ta=25°C

Parameter	Symbol	Conditions	Ratings			Unit
			min	typ	max	
Collector Cutoff Current	I_{CBO}	$V_{CB}=10V, I_E=0A$			1.0	μA
Emitter Cutoff Current	I_{EBO}	$V_{EB}=1V, I_C=0A$			10	μA
DC Current Gain	h_{FE}	$V_{CE}=5V, I_C=20mA$	60*		270*	
Gain-Bandwidth Product	f_T	$V_{CE}=5V, I_C=20mA$	5	7		GHz
Output Capacitance	C_{ob}	$V_{CB}=10V, f=1MHz$		0.75	1.2	pF
Reverse Transfer Capacitance	C_{re}	$V_{CB}=10V, f=1MHz$		0.5		pF
Forward Transfer Gain	$ S_{21e} ^2_1$	$V_{CE}=5V, I_C=20mA, f=1GHz$	9	12		dB
	$ S_{21e} ^2_2$	$V_{CE}=2V, I_C=3mA, f=1GHz$		8		dB
Noise Figure	NF	$V_{CE}=5V, I_C=7mA, f=1GHz$		1.0	1.8	dB

* : The 2SC5226A is classified by 20mA h_{FE} as follows :

Rank	3	4	5
h_{FE}	60 to 120	90 to 180	135 to 270

Ordering Information

Device	Package	Shipping	memo
2SC5226A-4-TL-E	MCP	3,000pcs./reel	Pb Free
2SC5226A-5-TL-E	MCP	3,000pcs./reel	

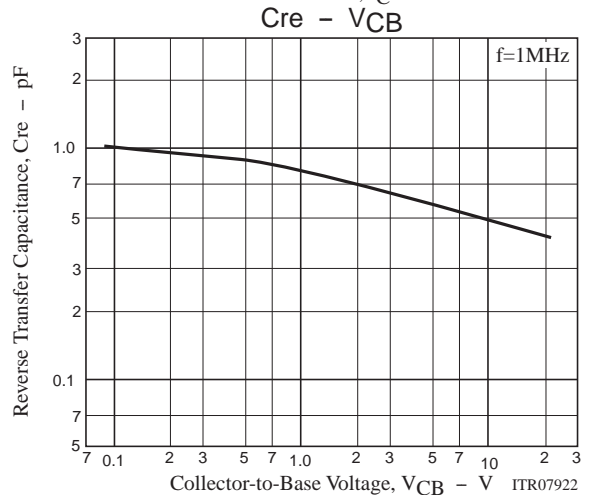
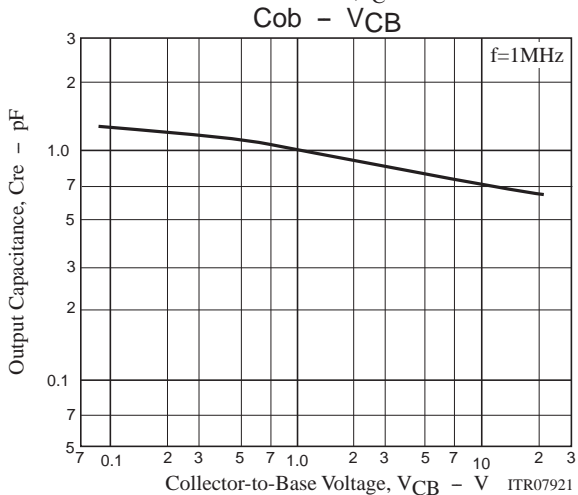
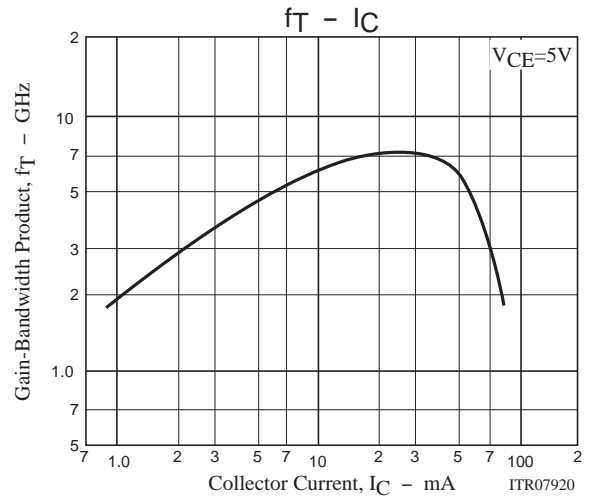
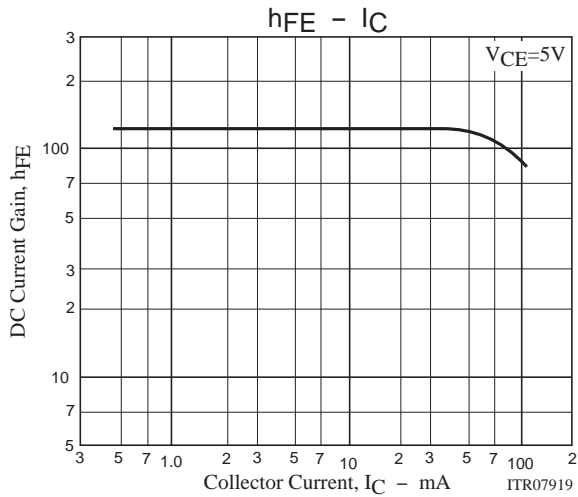

2SC5226A

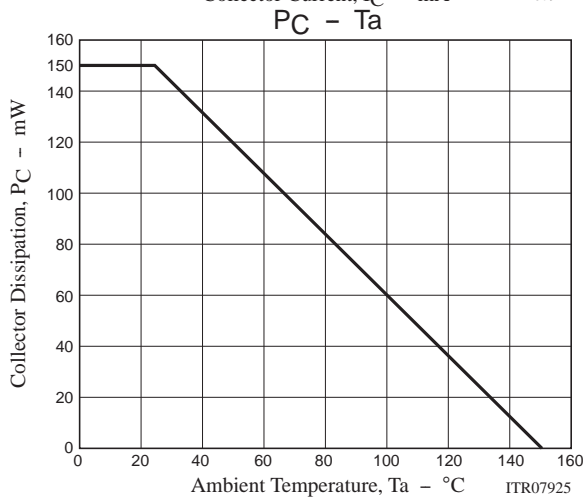
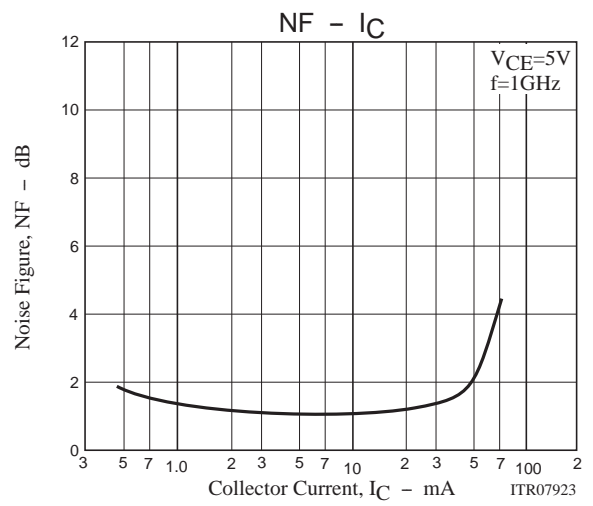
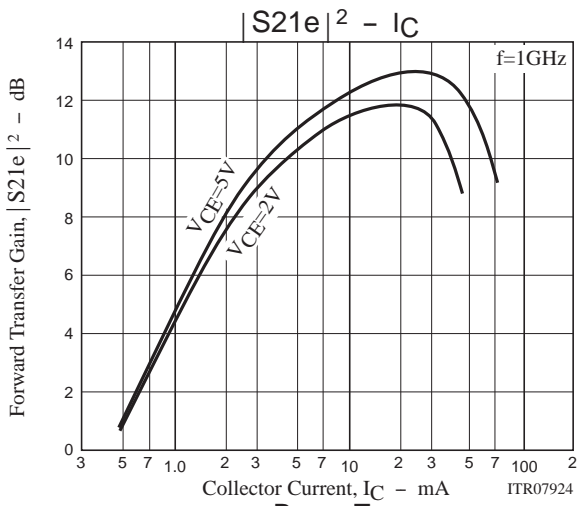

2SC5226A

f=100MHz, 200MHz to 2000MHz(200MHz Step)

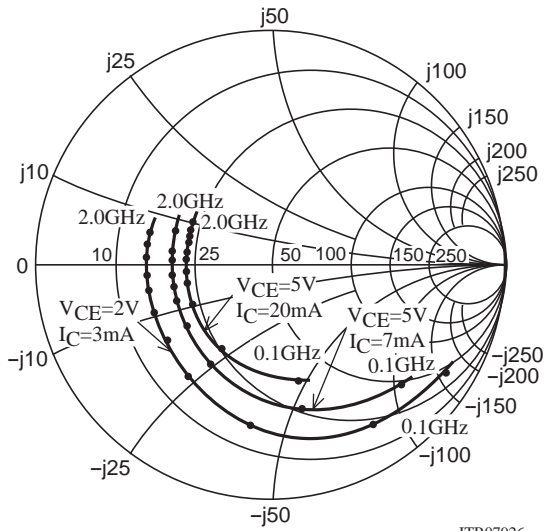

f=100MHz, 200MHz to 2000MHz(200MHz Step)

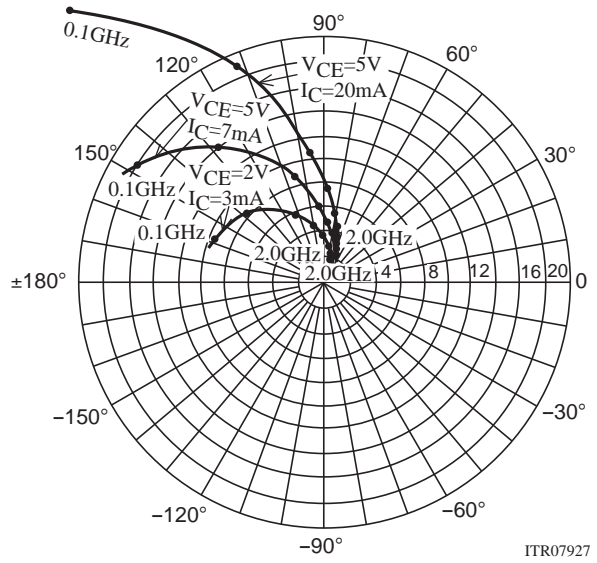

f=100MHz, 200MHz to 2000MHz(200MHz Step)

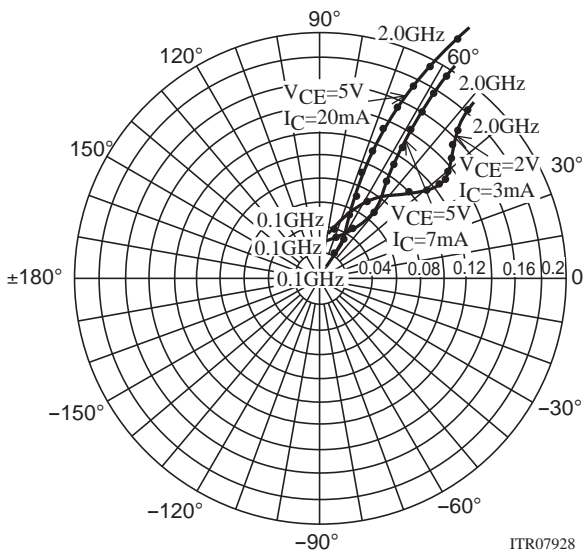

f=100MHz, 200MHz to 2000MHz(200MHz Step)

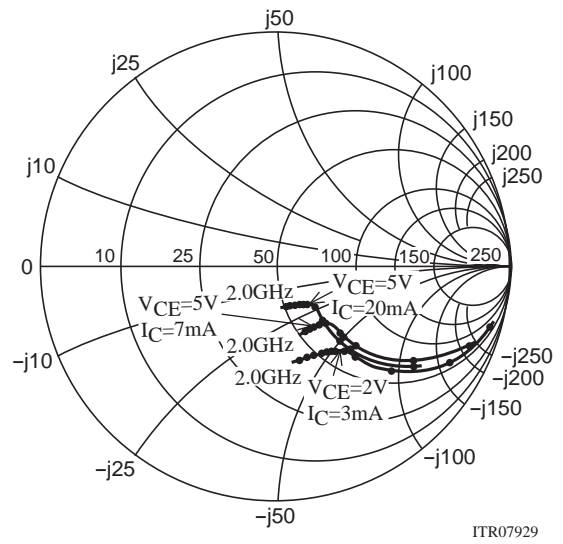

2SC5226A

S Parameters (Common emitter)

$V_{CE}=5V, I_C=7mA, Z_O=50\Omega$

Freq(MHz)	S11	$\angle S11$	S21	$\angle S21$	S12	$\angle S12$	S22	$\angle S22$
100	0.720	-46.0	17.973	148.5	0.030	68.5	0.880	-23.6
200	0.612	-80.9	13.927	127.3	0.047	57.1	0.697	-37.6
400	0.497	-121.3	8.656	105.0	0.066	51.3	0.479	-47.6
600	0.456	-143.5	6.080	92.8	0.079	52.9	0.382	-50.5
800	0.440	-157.6	4.725	84.3	0.094	55.4	0.339	-51.8
1000	0.436	-167.5	3.864	77.0	0.110	56.8	0.323	-53.4
1200	0.434	-176.1	3.258	70.3	0.126	57.9	0.312	-55.8
1400	0.433	176.6	2.847	64.5	0.143	58.4	0.304	-58.3
1600	0.433	170.9	2.329	57.4	0.160	58.9	0.296	-62.0
1800	0.434	165.0	2.252	54.2	0.178	58.6	0.293	-65.0
2000	0.439	159.6	2.057	49.2	0.197	58.1	0.294	-68.1

$V_{CE}=5V, I_C=20mA, Z_O=50\Omega$

Freq(MHz)	S11	$\angle S11$	S21	$\angle S21$	S12	$\angle S12$	S22	$\angle S22$
100	0.481	-78.8	29.795	132.9	0.022	63.9	0.707	-38.2
200	0.420	-119.2	19.008	112.2	0.033	60.8	0.470	-51.1
400	0.391	-151.6	10.416	95.4	0.052	64.7	0.296	-55.3
600	0.386	-166.4	7.084	86.6	0.071	67.2	0.236	-56.1
800	0.381	-175.9	5.407	80.1	0.092	68.4	0.213	-56.6
1000	0.382	178.2	4.401	74.1	0.114	67.8	0.208	-57.9
1200	0.385	172.1	3.701	68.5	0.134	66.8	0.204	-60.7
1400	0.388	166.7	3.217	63.6	0.156	65.6	0.202	-63.5
1600	0.390	162.1	2.839	58.8	0.176	64.0	0.199	-67.9
1800	0.391	156.7	2.534	54.3	0.197	62.4	0.197	-71.2
2000	0.394	152.1	2.319	50.1	0.219	60.6	0.197	-74.2

$V_{CE}=2V, I_C=3mA, Z_O=50\Omega$

Freq(MHz)	S11	$\angle S11$	S21	$\angle S21$	S12	$\angle S12$	S22	$\angle S22$
100	0.858	-32.4	9.413	157.2	0.040	72.6	0.945	-16.5
200	0.782	-60.7	8.187	138.5	0.070	59.2	0.833	-29.3
400	0.653	-101.1	5.855	113.8	0.101	44.5	0.637	-43.2
600	0.588	-126.5	4.337	98.4	0.114	39.1	0.515	-50.0
800	0.557	-143.7	3.444	87.7	0.122	38.0	0.454	-53.8
1000	0.543	-156.3	2.871	78.5	0.130	38.6	0.426	-57.1
1200	0.536	-166.8	2.446	70.5	0.137	40.3	0.407	-60.3
1400	0.533	-175.5	2.145	63.5	0.146	42.5	0.393	-63.8
1600	0.527	177.0	1.904	57.1	0.155	45.0	0.382	-68.0
1800	0.525	170.3	1.714	51.7	0.168	47.3	0.379	-72.0
2000	0.528	163.8	1.564	45.9	0.183	49.2	0.378	-75.8

Embossed Taping Specification

2SC5226A-4-TL-E, 2SC5226A-5-TL-E

1. Packing Format

Package Name	Carrier Tape Type	Maximum Number of devices contained (pcs)			Packing format	
		Reel	Inner box	Outer box	Inner BOX (C-1)	Outer BOX (A-7)
MCP	MCP	3,000	15,000	90,000	5 reels contained Dimensions:mm (external) 183×72×185	6 inner boxes contained Dimensions:mm (external) 440×195×210

Packing method

Reel label, Inner box label (unit:mm)

Outer box label
It is a label at the time of factory shipments. The form of a label may change in physical distribution process.

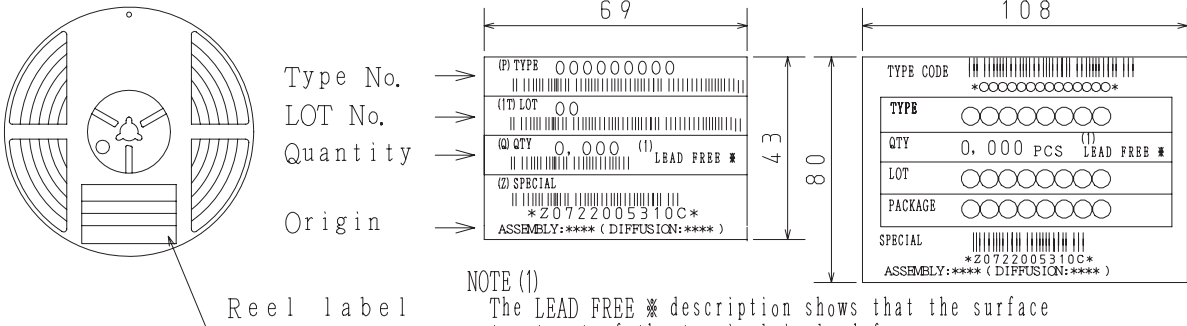

Label	JEITA Phase
LEAD FREE 3	JEITA Phase 3A
LEAD FREE 4	JEITA Phase 3

2. Taping configuration

2-1. Carrier tape size (unit:mm)

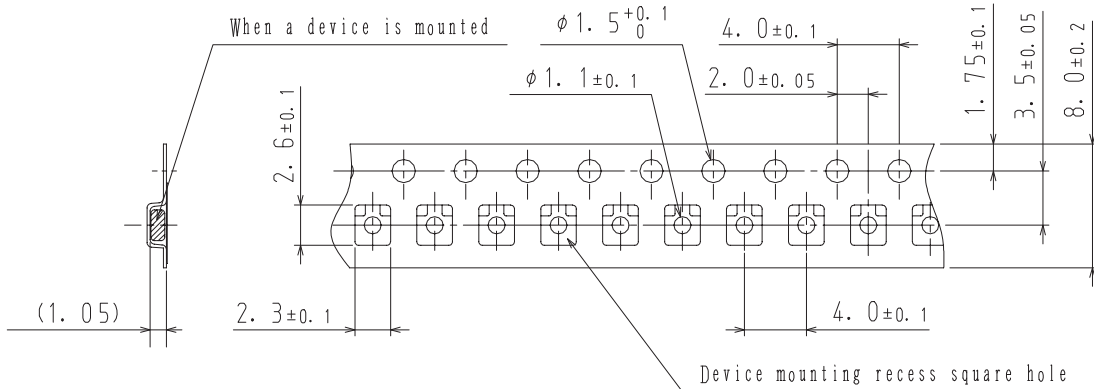

2-2. Device placement direction

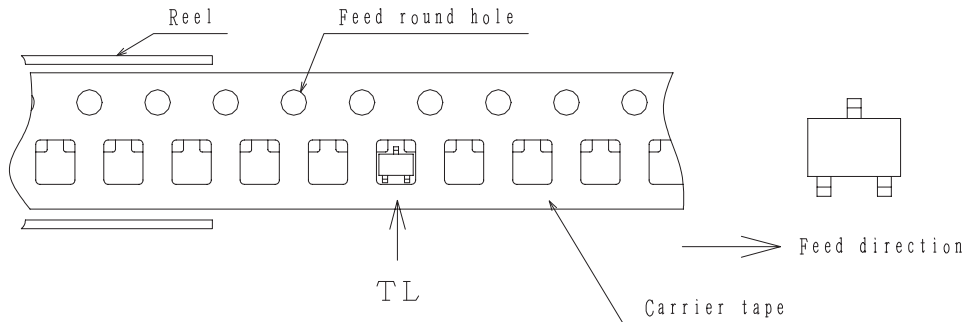

Those with oen electrode terminal on the feed hole side.....TL

2SC5226A

Outline Drawing

2SC5226A-4-TL-E, 2SC5226A-5-TL-E

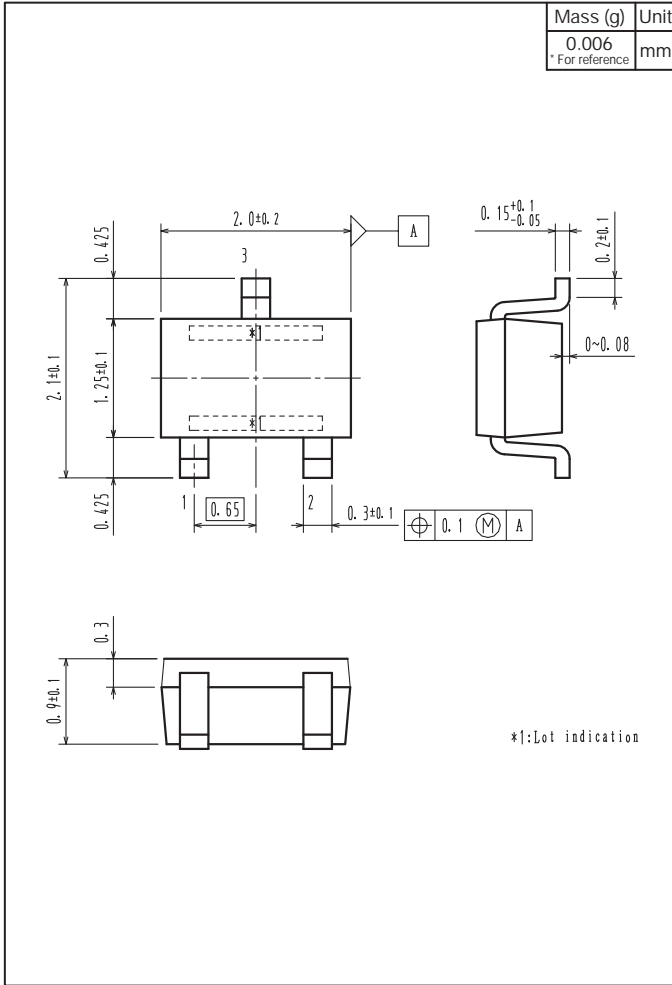

Land Pattern Example

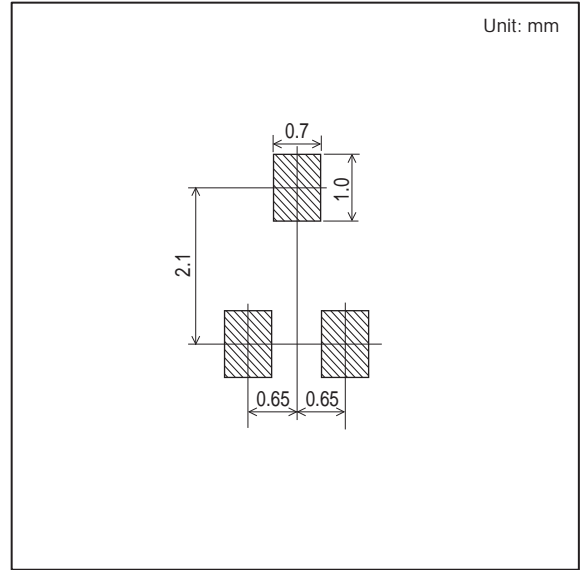

- Any and all SANYO Semiconductor Co.,Ltd. products described or contained herein are, with regard to "standard application", intended for the use as general electronics equipment. The products mentioned herein shall not be intended for use for any "special application" (medical equipment whose purpose is to sustain life, aerospace instrument, nuclear control device, burning appliances, transportation machine, traffic signal system, safety equipment etc.) that shall require extremely high level of reliability and can directly threaten human lives in case of failure or malfunction of the product or may cause harm to human bodies, nor shall they grant any guarantee thereof. If you should intend to use our products for new introduction or other application different from current conditions on the usage of automotive device, communication device, office equipment, industrial equipment etc. , please consult with us about usage condition (temperature, operation time etc.) prior to the intended use. If there is no consultation or inquiry before the intended use, our customer shall be solely responsible for the use.
- Specifications of any and all SANYO Semiconductor Co.,Ltd. products described or contained herein stipulate the performance, characteristics, and functions of the described products in the independent state, and are not guarantees of the performance, characteristics, and functions of the described products as mounted in the customer's products or equipment. To verify symptoms and states that cannot be evaluated in an independent device, the customer should always evaluate and test devices mounted in the customer's products or equipment.
- SANYO Semiconductor Co.,Ltd. assumes no responsibility for equipment failures that result from using products at values that exceed, even momentarily, rated values (such as maximum ratings, operating condition ranges, or other parameters) listed in products specifications of any and all SANYO Semiconductor Co.,Ltd. products described or contained herein.
- Regarding monolithic semiconductors, if you should intend to use this IC continuously under high temperature, high current, high voltage, or drastic temperature change, even if it is used within the range of absolute maximum ratings or operating conditions, there is a possibility of decrease reliability. Please contact us for a confirmation.
- SANYO Semiconductor Co.,Ltd. strives to supply high-quality high-reliability products, however, any and all semiconductor products fail or malfunction with some probability. It is possible that these probabilistic failures or malfunction could give rise to accidents or events that could endanger human lives, trouble that could give rise to smoke or fire, or accidents that could cause damage to other property. When designing equipment, adopt safety measures so that these kinds of accidents or events cannot occur. Such measures include but are not limited to protective circuits and error prevention circuits for safe design, redundant design, and structural design.
- In the event that any or all SANYO Semiconductor Co.,Ltd. products described or contained herein are controlled under any of applicable local export control laws and regulations, such products may require the export license from the authorities concerned in accordance with the above law.
- No part of this publication may be reproduced or transmitted in any form or by any means, electronic or mechanical, including photocopying and recording, or any information storage or retrieval system, or otherwise, without the prior written consent of SANYO Semiconductor Co.,Ltd.
- Any and all information described or contained herein are subject to change without notice due to product/technology improvement, etc. When designing equipment, refer to the "Delivery Specification" for the SANYO Semiconductor Co.,Ltd. product that you intend to use.
- Upon using the technical information or products described herein, neither warranty nor license shall be granted with regard to intellectual property rights or any other rights of SANYO Semiconductor Co.,Ltd. or any third party. SANYO Semiconductor Co.,Ltd. shall not be liable for any claim or suits with regard to a third party's intellectual property rights which has resulted from the use of the technical information and products mentioned above.

This catalog provides information as of July, 2012. Specifications and information herein are subject to change without notice.

Компания «Океан Электроники» предлагает заключение долгосрочных отношений при поставках импортных электронных компонентов на взаимовыгодных условиях!

Наши преимущества:

- Поставка оригинальных импортных электронных компонентов напрямую с производств Америки, Европы и Азии, а так же с крупнейших складов мира;
- Широкая линейка поставок активных и пассивных импортных электронных компонентов (более 30 млн. наименований);
- Поставка сложных, дефицитных, либо снятых с производства позиций;
- Оперативные сроки поставки под заказ (от 5 рабочих дней);
- Экспресс доставка в любую точку России;
- Помощь Конструкторского Отдела и консультации квалифицированных инженеров;
- Техническая поддержка проекта, помощь в подборе аналогов, поставка прототипов;
- Поставка электронных компонентов под контролем ВП;
- Система менеджмента качества сертифицирована по Международному стандарту ISO 9001;
- При необходимости вся продукция военного и аэрокосмического назначения проходит испытания и сертификацию в лаборатории (по согласованию с заказчиком);
- Поставка специализированных компонентов военного и аэрокосмического уровня качества (Xilinx, Altera, Analog Devices, Intersil, Interpoint, Microsemi, Actel, Aeroflex, Peregrine, VPT, Syfer, Eurofarad, Texas Instruments, MS Kennedy, Miteq, Cobham, E2V, MA-COM, Hittite, Mini-Circuits, General Dynamics и др.);

Компания «Океан Электроники» является официальным дистрибьютором и эксклюзивным представителем в России одного из крупнейших производителей разъемов военного и аэрокосмического назначения «JONHON», а так же официальным дистрибьютором и эксклюзивным представителем в России производителя высокотехнологичных и надежных решений для передачи СВЧ сигналов «FORSTAR».



JONHON

«JONHON» (основан в 1970 г.)

Разъемы специального, военного и аэрокосмического назначения:

(Применяются в военной, авиационной, аэрокосмической, морской, железнодорожной, горно- и нефтедобывающей отраслях промышленности)

«FORSTAR» (основан в 1998 г.)

ВЧ соединители, коаксиальные кабели, кабельные сборки и микроволновые компоненты:

(Применяются в телекоммуникациях гражданского и специального назначения, в средствах связи, РЛС, а так же военной, авиационной и аэрокосмической отраслях промышленности).



Телефон: 8 (812) 309-75-97 (многоканальный)

Факс: 8 (812) 320-03-32

Электронная почта: ocean@oceanchips.ru

Web: <http://oceanchips.ru/>

Адрес: 198099, г. Санкт-Петербург, ул. Калинина, д. 2, корп. 4, лит. А