



# Low-Cost Sample-and-Hold Amplifier

## AD582

### FEATURES

- Suitable for 12-Bit Applications
- High Sample/Hold Current Ratio:  $10^7$
- Low Acquisition Time:  $6\mu\text{s}$  to 0.1%
- Low Charge Transfer:  $<2\text{pC}$
- High Input Impedance in Sample-and-Hold Modes
- Connect in Any Op Amp Configuration
- Differential Logic Inputs
- MIL-STD-883 Compliant Versions Available

### PRODUCT DESCRIPTION

The AD582 is a low-cost integrated circuit sample-and-hold amplifier consisting of a high performance operational amplifier, a low leakage analog switch and a JFET integrating amplifier — all fabricated on a single monolithic chip. An external holding capacitor, connected to the device, completes the sample-and-hold function.

With the analog switch closed, the AD582 functions like a standard op amp; any feedback network may be connected around the device to control gain and frequency response. With the switch open, the capacitor holds the output at its last level, regardless of input voltage.

Typical applications for the AD582 include sampled data systems, D/A deglitchers, analog de-multiplexers, auto null systems, strobed measurement systems and A/D speed enhancement.

The device is available in two versions: the "K" specified for operation over the 0 to  $+70^\circ\text{C}$  commercial temperature range and the "S" specified over the extended temperature range,  $-55^\circ\text{C}$  to  $+125^\circ\text{C}$ . All versions may be obtained in either the hermetic sealed, TO-100 can or the TO-116 DIP.

### PRODUCT HIGHLIGHTS

- The specially designed input stage presents a high impedance to the signal source in both sample and hold modes (up to  $\pm 12\text{V}$ ). Even with signal levels up to  $\pm V_S$ , no undesirable signal inversion, peaking or loss of hold voltage occurs.
- The AD582 may be connected in any standard op amp configuration to control gain or frequency response and provide signal inversion, etc.

### REV. A

Information furnished by Analog Devices is believed to be accurate and reliable. However, no responsibility is assumed by Analog Devices for its use; nor for any infringements of patents or other rights of third parties which may result from its use. No license is granted by implication or otherwise under any patent or patent rights of Analog Devices.

### PIN CONFIGURATIONS

10-Pin TO-100

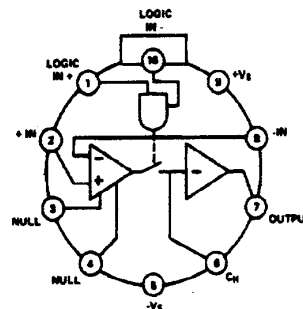

TOP VIEW

14-Pin DIP TO-116

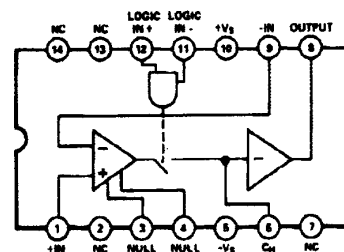

- The AD582 offers a high, sample-to-hold current ratio:  $10^7$ . The ratio of the available charging current to the holding leakage current is often used as a figure of merit for a sample and hold circuit.
- The AD582 has a typical charge transfer less than  $2\text{pC}$ . A low charge transfer produces less offset error and permits the use of smaller hold capacitors for faster signal acquisition.
- The AD582 provides separate analog and digital grounds, thus improving the device's immunity to ground and switching transients.
- The AD582 is available in versions compliant with MIL-STD-883. Refer to the Analog Devices Military Products Databook or current AD582/883B data sheet for detailed specifications.

One Technology Way, P.O. Box 9106, Norwood, MA 02062-0106, U.S.A.  
Tel: 617/329-4700 Fax: 617/329-8788 Telex: 710/304-6577  
Telefax: 324481 Cable: ANALOG NORWOODMASS

# AD582—SPECIFICATIONS (typical @ +25°C, V<sub>S</sub> = ±15V and C<sub>H</sub> = 1000pF, A = +1 unless otherwise specified)

MODEL	AD582K	AD582S
<b>SAMPLE/HOLD CHARACTERISTICS</b>		
Acquisition Time, 10V Step to 0.1%, C <sub>H</sub> = 100pF	6μs	*
Acquisition Time, 10V Step to 0.01%, C <sub>H</sub> = 1000pF	25μs	*
Aperture Delay, 20V p-p Input, Hold 0V	200ns	*
Aperture Jitter, 20V p-p Input, Hold 0V	15ns	*
Settling Time, 20V p-p Input, Hold 0V, to 0.01%	0.5μs	*
Droop Current, Steady State, ±10V <sub>OUT</sub>	100pA max	*
Droop Current, T <sub>min</sub> to T <sub>max</sub>	1nA	150nA max
Charge Transfer	5pC max (1.5pC typ)	*
Sample to Hold Offset	0.5mV	*
Feedthrough Capacitance 20V p-p, 10kHz Input	0.05pF	*
<b>TRANSFER CHARACTERISTICS</b>		
Open Loop Gain V <sub>OUT</sub> = 20V p-p, R <sub>L</sub> = 2k	25k min (50k typ)	*
Common Mode Rejection V <sub>CM</sub> = 20V p-p	60dB min (70dB typ)	*
Small Signal Gain Bandwidth V <sub>OUT</sub> = 100mV p-p, C <sub>H</sub> = 100pF	1.5MHz	*
Full Power Bandwidth V <sub>OUT</sub> = 20V p-p, C <sub>H</sub> = 100pF	70kHz	*
Slew Rate V <sub>OUT</sub> = 20V p-p, C <sub>H</sub> = 100pF	3V/μs	*
Output Resistance Hold Mode, I <sub>OUT</sub> = ±5mA	12Ω	*
Linearity V <sub>OUT</sub> = 20V p-p, R <sub>L</sub> = 2k	±0.01%	*
Output Short Circuit Current	±25mA	*
<b>ANALOG INPUT CHARACTERISTICS</b>		
Offset Voltage	6mV max (2mV typ)	*
Offset Voltage, T <sub>min</sub> to T <sub>max</sub>	4mV	8mV max (5mV typ)
Bias Current	3μA max (1.5μA typ)	*
Offset Current	300nA max (75nA typ)	*
Offset Current, T <sub>min</sub> to T <sub>max</sub>	100nA	400nA max (100nA typ)
Input Capacitance, f = 1MHz	2pF	*
Input Resistance, Sample or Hold 20V p-p Input, A = +1	30MΩ	*
Absolute Max Diff Input Voltage	30V	*
Absolute Max Input Voltage, Either Input	±V <sub>S</sub>	*
<b>DIGITAL INPUT CHARACTERISTICS</b>		
+Logic Input Voltage Hold Mode, T <sub>min</sub> to T <sub>max</sub> , -Logic @ 0V	+2V min	*
Sample Mode, T <sub>min</sub> to T <sub>max</sub> , -Logic @ 0V	+0.8V max	*
+Logic Input Current Hold Mode, +Logic @ +5V, -Logic @ 0V	1.5μA	*
Sample Mode, +Logic @ 0V, -Logic @ 0V	1nA	*
-Logic Input Current Hold Mode, +Logic @ +5V, -Logic @ 0V	24μA	*
Sample Mode, +Logic @ 0V, -Logic @ 0V	4μA	*
Absolute Max Diff Input Voltage, +L to -L	+15V/-6V	*
Absolute Max Input Voltage, Either Input	±V <sub>S</sub>	*
<b>POWER SUPPLY CHARACTERISTICS</b>		
Operating Voltage Range	±9V to ±18V	±9V to ±22V
Supply Current, R <sub>L</sub> = ∞	4.5mA max (3mA typ)	*
Power Supply Rejection, ΔV <sub>S</sub> = 5V, Sample Mode (see next page)	60dB min (75dB typ)	*
<b>TEMPERATURE RANGE</b>		
Specified Performance	0 to +70°C	-55°C to +125°C
Operating	-25°C to +85°C	-55°C to +125°C
Storage	-65°C to +150°C	*
Lead Temperature (Soldering, 15 sec)	+300°C	*
<b>PACKAGE OPTION<sup>1,2</sup></b>		
TO-100 (H-10A)	AD582KH	AD582SH
TO-116 (D-14)	AD582KD	AD582SD

**NOTES**

\*Specifications same as AD582K.

<sup>1</sup>D = Ceramic DIP; H = Hermetic Metal Can. For outline information see Package Information section.

<sup>2</sup>For AD582/803B specifications, refer to Analog Devices Military Products Databook.

Specifications subject to change without notice.

# Applying the AD582

## APPLYING THE AD582

Both the inverting and non-inverting inputs are brought out to allow op amp type versatility in connecting and using the AD582. Figure 1 shows the basic non-inverting unity gain connection requiring only an external hold capacitor and the usual power supply bypass capacitors. An offset null pot can be added for more critical applications.

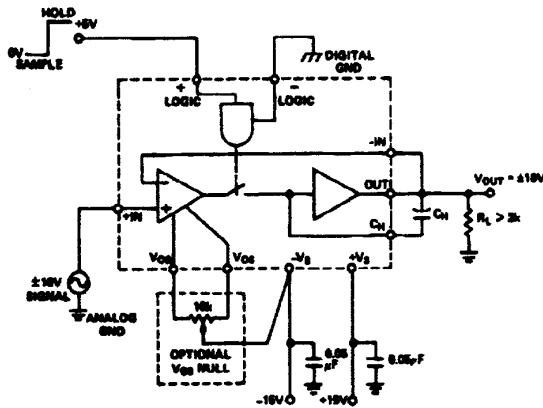

Figure 1. Sample and Hold with  $A = +1$

Figure 2 shows a non-inverting configuration where voltage gain,  $A_V$ , is set by a pair of external resistors. Frequency shaping or non-linear networks can also be used for special applications.

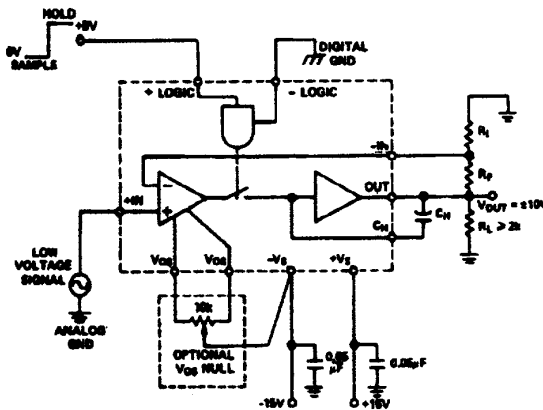

Figure 2. Sample and Hold with  $A = (1 + R_F/R_I)$

The hold capacitor,  $C_H$ , should be a high quality polystyrene (for temperatures below  $+85^\circ\text{C}$ ) or Teflon type with low dielectric absorption. For high speed, limited accuracy applications, capacitors as small as 100pF may be used. Larger values are required for accuracies of 12 bits and above in order to minimize feedthrough, sample to hold offset and droop errors (see Figure 6). Care should be taken in the circuit layout to minimize coupling between the hold capacitor and the digital or signal inputs.

In the hold mode, the output voltage will follow any change in the  $-V_S$  supply. Consequently, this supply should be well regulated and filtered.

Biasing the +Logic Input anywhere between  $-6\text{V}$  to  $+0.8\text{V}$  with respect to the -Logic will set the sample mode. The hold mode will result from any bias between  $+2.0\text{V}$  and  $(+V_S - 3\text{V})$ . The sample and hold modes will be controlled differentially with the absolute voltage at either logic input ranging from  $-V_S$  to within  $3\text{V}$  of  $+V_S$  ( $V_S - 3\text{V}$ ). Figure 3 illustrates some examples of the flexibility of this feature.

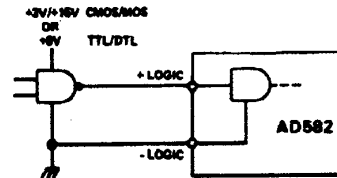

Figure 3A. Standard Logic Connection

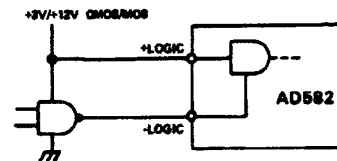

Figure 3B. Inverted Logic Sense Connection

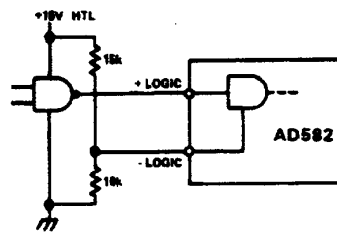

Figure 3C. High Threshold Logic Connection

## DEFINITION OF TERMS

Figure 4 illustrates various dynamic characteristics of the AD582.

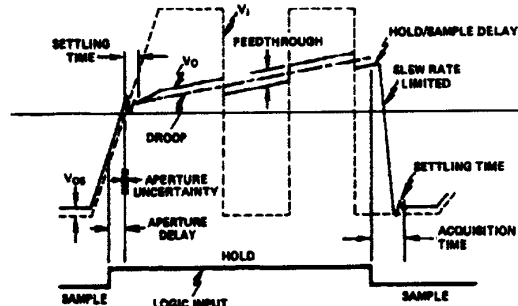

Figure 4. Pictorial Showing Various S/H Characteristics

# AD582

**Aperture Delay** is the time required after the "hold" command until the switch is fully open and produces a delay in the effective sample timing. Figure 5 is a plot giving the maximum frequency at which the AD582 can sample an input with a given accuracy (lower curve).

**Aperture Jitter** is the uncertainty in Aperture Time. The Aperture Time can be eliminated by advancing the sample-to-hold command 200ns with respect to the input signal. The Aperture Jitter now determines the maximum sampling frequency (upper curve of Figure 5).

**Acquisition Time** is the time required by the device to reach its final value within a given error band after the sample command has been given. This includes switch delay time, slewing time and settling time for a given output voltage change.

**Droop** is the change in the output voltage from the "held" value as a result of device leakage. In the AD582, droop can be in either the positive or negative direction. Droop rate may be calculated from droop current using the following formula:

$$\frac{\Delta V}{\Delta T} \text{ (Volts/sec)} = \frac{I \text{ (pA)}}{C_H \text{ (pF)}}$$

(See also Figure 6.)

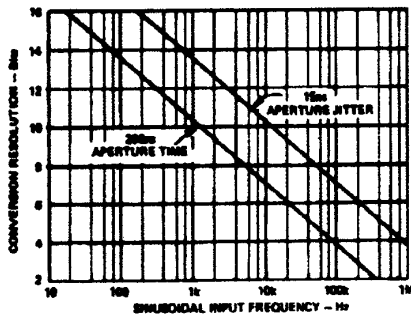

Figure 5. Maximum Frequency of Input Signal for 1/2 LSB Sampling Accuracy

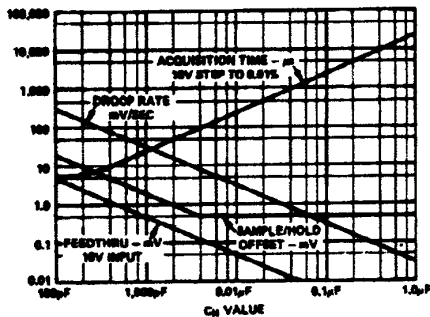

Figure 6. Sample-and-Hold Performance as a Function of Hold Capacitance

**Feedthrough** is that component of the output which follows the input signal after the switch is open. As a percentage of the input, feedthrough is determined as the ratio of the feedthrough capacitance to the hold capacitance ( $C_F/C_H$ ).

**Sample-to-Hold Offset** is an output shift or step caused by charge injection into the hold capacitor as the device is switched from sample to hold. The charge transfer generates a sample-to-hold offset where:

$$\text{S/H Offset (V)} = \frac{\text{Charge (pC)}}{C_H \text{ (pF)}}$$

This offset also has a dc component as shown in Figure 6.

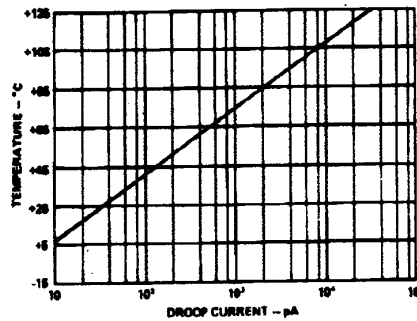
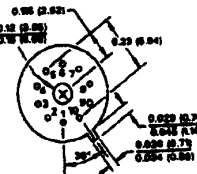
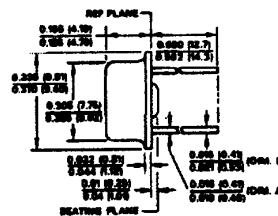

Figure 7. Droop Current vs. Temperature

## OUTLINE DIMENSIONS

Dimensions shown in inches and (mm).

### TO-100 "H"



### TO-116 "D"

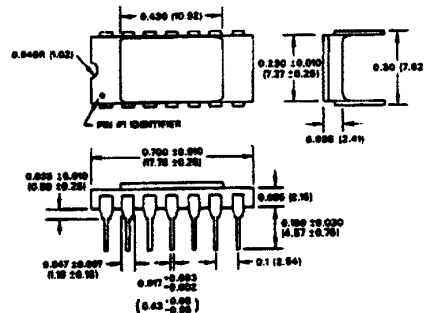

C638c-6-6/86

PRINTED IN U.S.A.

Компания «Океан Электроники» предлагает заключение долгосрочных отношений при поставках импортных электронных компонентов на взаимовыгодных условиях!

Наши преимущества:

- Поставка оригинальных импортных электронных компонентов напрямую с производств Америки, Европы и Азии, а так же с крупнейших складов мира;
- Широкая линейка поставок активных и пассивных импортных электронных компонентов (более 30 млн. наименований);
- Поставка сложных, дефицитных, либо снятых с производства позиций;
- Оперативные сроки поставки под заказ (от 5 рабочих дней);
- Экспресс доставка в любую точку России;
- Помощь Конструкторского Отдела и консультации квалифицированных инженеров;
- Техническая поддержка проекта, помощь в подборе аналогов, поставка прототипов;
- Поставка электронных компонентов под контролем ВП;
- Система менеджмента качества сертифицирована по Международному стандарту ISO 9001;
- При необходимости вся продукция военного и аэрокосмического назначения проходит испытания и сертификацию в лаборатории (по согласованию с заказчиком);
- Поставка специализированных компонентов военного и аэрокосмического уровня качества (Xilinx, Altera, Analog Devices, Intersil, Interpoint, Microsemi, Actel, Aeroflex, Peregrine, VPT, Syfer, Eurofarad, Texas Instruments, MS Kennedy, Miteq, Cobham, E2V, MA-COM, Hittite, Mini-Circuits, General Dynamics и др.);

Компания «Океан Электроники» является официальным дистрибьютором и эксклюзивным представителем в России одного из крупнейших производителей разъемов военного и аэрокосмического назначения «JONHON», а так же официальным дистрибьютором и эксклюзивным представителем в России производителя высокотехнологичных и надежных решений для передачи СВЧ сигналов «FORSTAR».



## JONHON

«JONHON» (основан в 1970 г.)

Разъемы специального, военного и аэрокосмического назначения:

(Применяются в военной, авиационной, аэрокосмической, морской, железнодорожной, горно- и нефтедобывающей отраслях промышленности)

«FORSTAR» (основан в 1998 г.)

ВЧ соединители, коаксиальные кабели, кабельные сборки и микроволновые компоненты:

(Применяются в телекоммуникациях гражданского и специального назначения, в средствах связи, РЛС, а так же военной, авиационной и аэрокосмической отраслях промышленности).



Телефон: 8 (812) 309-75-97 (многоканальный)

Факс: 8 (812) 320-03-32

Электронная почта: [ocean@oceanchips.ru](mailto:ocean@oceanchips.ru)

Web: <http://oceanchips.ru/>

Адрес: 198099, г. Санкт-Петербург, ул. Калинина, д. 2, корп. 4, лит. А