

# Single 8-Ch/Differential 4-Ch Latchable Analog Multiplexers

## DESCRIPTION

The DG428, DG429 analog multiplexers have on-chip address and control latches to simplify design in microprocessor based applications. Break-before-make switching action protects against momentary crosstalk of adjacent input signals.

The DG428 selects one of eight single-ended inputs to a common output, while the DG429 selects one of four differential inputs to a common differential output.

An on channel conducts current equally well in both directions. In the off state each channel blocks voltages up to the power supply rails. An enable (EN) function allows the user to reset the multiplexer/demultiplexer to all switches off for stacking several devices. All control inputs, address ( $A_x$ ) and enable (EN) are TTL compatible over the full specified operating temperature range.

The silicon-gate CMOS process enables operation over a wide range of supply voltages. The absolute maximum voltage rating is extended to 44 V. Additionally, single supply operation is also allowed and an epitaxial layer prevents latchup.

On-board TTL-compatible address latches simplify the digital interface design and reduce board space in bus-controlled systems such as data acquisition systems, process controls, avionics, and ATE.

## FEATURES

- **Halogen-free according to IEC 61249-2-21 Definition**
- Low  $R_{DS(on)}$ : 55  $\Omega$
- Low Charge Injection: 1 pC
- On-Board TTL Compatible Address Latches
- High Speed -  $t_{TRANS}$ : 160 ns
- Break-Before-Make
- Low Power Consumption: 0.3 mW
- Compliant to RoHS Directive 2002/95/EC



**RoHS**  
COMPLIANT  
HALOGEN  
**FREE**

## BENEFITS

- Improved System Accuracy
- Microprocessor Bus Compatible
- Easily Interfaced
- Reduced Crosstalk
- High Throughput
- Improved Reliability

## APPLICATIONS

- Data Acquisition Systems
- Automatic Test Equipment
- Avionics and Military Systems
- Communication Systems
- Microprocessor-Controlled Analog Systems
- Medical Instrumentation

## FUNCTIONAL BLOCK DIAGRAM AND PIN CONFIGURATION



## FUNCTIONAL BLOCK DIAGRAM AND PIN CONFIGURATION



TRUTH TABLE - DG428						
8-Channel Single-Ended Multiplexer						
A <sub>2</sub>	A <sub>1</sub>	A <sub>0</sub>	EN	WR	RS	On Switch
<b>Latching</b>						
X	X	X	X		1	Maintains previous switch condition
<b>Reset</b>						
X	X	X	X	X	0	None (latches cleared)
<b>Transparent Operation</b>						
X	X	X	0	0	1	None
0	0	0	1	0	1	1
0	0	1	1	0	1	2
0	1	0	1	0	1	3
0	1	1	1	0	1	4
1	0	0	1	0	1	5
1	0	1	1	0	1	6
1	1	0	1	0	1	7
1	1	1	1	0	1	8

TRUTH TABLE - DG429					
Differential 4-Channel Multiplexer					
A <sub>1</sub>	A <sub>0</sub>	EN	WR	RS	On Switch
<b>Latching</b>					
X	X	X		1	Maintains previous switch condition
<b>Reset</b>					
X	X	X	X	0	None (latches cleared)
<b>Transparent Operation</b>					
X	X	0	0	1	None
0	0	1	0	1	1
0	1	1	0	1	2
1	0	1	0	1	3
1	1	1	0	1	4

Logic "0" =  $V_{AL} \leq 0.8\text{ V}$   
 Logic "1" =  $V_{AH} \geq 2.4\text{ V}$   
 X = Don't Care

ORDERING INFORMATION - DG428		
Temp Range	Package	Part Number
- 40 °C to 85 °C	18-pin Plastic DIP	DG428DJ
		DG428DJ-E3
	20-pin PLCC	DG428DN
		DG428DN-E3

ORDERING INFORMATION - DG429		
Temp Range	Package	Part Number
- 40 °C to 85 °C	18-pin Plastic DIP	DG429DJ
		DG429DJ-E3
	20-pin PLCC	DG429DN
		DG429DN-E3
	18-pin Widebody SOIC	DG429DW
		DG429DW-E3



<b>ABSOLUTE MAXIMUM RATINGS</b> ( $T_A = 25\text{ }^\circ\text{C}$ , unless otherwise noted)				
Parameter		Symbol	Limit	Unit
Voltages Referenced to V-	V+		44	V
	GND		25	
Digital Inputs <sup>a</sup> , V <sub>S</sub> , V <sub>D</sub>			(V-) - 2 V to (V+) + 2 V or 30 mA, whichever occurs first	
Current (Any Terminal)			30	mA
Peak Current, S or D (Pulsed at 1 ms, 10 % Duty Cycle Max)			100	
Storage Temperature	(AK Suffix)		- 65 to 150	°C
	(DJ, DN Suffix)		- 65 to 125	
Power Dissipation (Package) <sup>b</sup>	18-pin Plastic DIP <sup>c</sup>		470	mW
	18-pin CerDIP <sup>d</sup>		900	
	20-pin PLCC <sup>e</sup>		800	
	28-Pin Widebody SOIC <sup>f</sup>		450	

**Notes:**

- a. Signals on S<sub>X</sub>, D<sub>X</sub> or IN<sub>X</sub> exceeding V+ or V- will be clamped by internal diodes. Limit forward diode current to maximum current ratings.
- b. All leads soldered or welded to PC board.
- c. Derate 6.3 mW/°C above 75 °C.
- d. Derate 12 mW/°C above 75 °C.
- e. Derate 10 mW/°C above 75 °C.
- f. Derate 6 mW/°C above 75 °C.



SPECIFICATIONS <sup>a</sup>											
Parameter	Symbol	Test Conditions Unless Otherwise Specified $V_+ = 15\text{ V}$ , $V_- = -15\text{ V}$ , $WR = 0$ , $\overline{RS} = 2.4\text{ V}$ , $V_{IN} = 2.4\text{ V}$ , $0.8\text{ V}^f$			Temp. <sup>b</sup>	Typ. <sup>c</sup>	A Suffix -55 °C to 125 °C		D Suffix -40 °C to 85 °C		Unit
		Min. <sup>d</sup>	Max. <sup>d</sup>	Min. <sup>d</sup>			Max. <sup>d</sup>				
<b>Analog Switch</b>											
Analog Signal Range <sup>e</sup>	$V_{ANALOG}$			Full			-15	15	-15	15	V
Drain-Source On-Resistance	$R_{DS(on)}$	$V_D = \pm 10\text{ V}$ , $V_{AL} = 0.8\text{ V}$ $I_S = -1\text{ mA}$ , $V_{AH} = 2.4\text{ V}$		Room Full	55			100 125		100 125	$\Omega$
Greatest Change in $R_{DS(on)}$ Between Channels <sup>g</sup>	$\Delta R_{DS(on)}$	$-10\text{ V} < V_S < 10\text{ V}$ $I_S = -1\text{ mA}$		Room	5						%
Source Off Leakage Current	$I_{S(off)}$	$V_S = \pm 10\text{ V}$ , $V_{EN} = 0\text{ V}$ , $V_D = \pm 10\text{ V}$		Room Full	$\pm 0.03$		-0.5 -50	0.5 50	-0.5 -50	0.5 50	
Drain Off Leakage Current	$I_{D(off)}$	$V_{EN} = 0\text{ V}$ $V_D = \pm 10\text{ V}$ $V_S = \pm 10\text{ V}$	DG428	Room Full	$\pm 0.07$		-1 -100	1 100	-1 -100	1 100	nA
			DG429	Room Full	$\pm 0.05$		-1 -50	1 50	-1 -50	1 50	
Drain On Leakage Current	$I_{D(on)}$	$V_S = V_D = \pm 10\text{ V}$ $V_{EN} = 2.4\text{ V}$ $V_{AL} = 0.8\text{ V}$ $V_{AH} = 2.4\text{ V}$	DG428	Room Full	$\pm 0.07$		-1 -100	1 100	-1 -100	1 100	nA
			DG429	Room Full	$\pm 0.05$		-1 -50	1 50	-1 -50	1 50	
<b>Digital Control</b>											
Logic Input Current Input Voltage High	$I_{AH}$	$V_A = 2.4\text{ V}$		Full	0.01			1		1	$\mu\text{A}$
		$V_A = 15\text{ V}$		Full	0.01			1		1	
Logic Input Current Input Voltage Low	$I_{AL}$	$V_{EN} = 0\text{ V}$ , $2.4\text{ V}$ , $V_A = 0\text{ V}$ $\overline{RS} = 0\text{ V}$ , $WR = 0\text{ V}$		Full	-0.01		-1		-1		$\mu\text{A}$
Logic Input Capacitance	$C_{in}$	$f = 1\text{ MHz}$		Room	8						pF
<b>Dynamic Characteristics</b>											
Transition Time	$t_{TRANS}$	See Figure 5		Room Full	150			250 300		250 300	ns
Break-Before-Make Interval	$t_{OPEN}$	See Figure 4		Full	30	10			10		
Enable and Write Turn-On Time	$t_{ON(EN,WR)}$	See Figure 6 and 7		Room Full	90			150 225		150 225	
Enable and Reset Turn-Off Time	$t_{OFF(EN,RS)}$	See Figure 6 and 8		Room Full	55			150 300		150 300	
Charge Injection	Q	$V_{GEN} = 0\text{ V}$ , $R_{GEN} = 0\ \Omega$ $C_L = 1\text{ nF}$ , See Figure 9		Room	1						pC
Off Isolation	OIRR	$V_{EN} = 0\text{ V}$ , $R_L = 300\ \Omega$ $C_L = 15\text{ pF}$ , $V_S = 7\text{ V}_{RMS}$ $f = 100\text{ kHz}$		Room	-75						dB
Source Off Capacitance	$C_{S(off)}$	$V_S = 0\text{ V}$ , $V_{EN} = 0\text{ V}$ , $f = 1\text{ MHz}$		Room	11						pF
Drain Off Capacitance	$C_{D(off)}$	$V_D = 0\text{ V}$ $V_{EN} = 0\text{ V}$ $f = 1\text{ MHz}$	DG428	Room	40						
			DG429	Room	20						
Drain On Capacitance	$C_{D(on)}$	$f = 1\text{ MHz}$	DG428	Room	54						
			DG429	Room	34						
<b>Minimum Input Timing Requirements</b>											
Write Pulse Width	$t_W$	See Figure 2		Full		100			100		ns
$A_X$ , EN Data Set Up time	$t_S$		Full		100			100			
$A_X$ , EN Data Hold Time	$t_H$		Full		10			10			
Reset Pulse Width	$t_{RS}$	$V_S = 5\text{ V}$ , See Figure 3		Full		100			100		
<b>Power Supplies</b>											
Positive Supply Current	I+	$V_{EN} = V_A = 0$ , $\overline{RS} = 5\text{ V}$		Room	20			100		100	$\mu\text{A}$
Negative Supply Current	I-		Room	-0.001		-5			-5		



SPECIFICATIONS <sup>a</sup> (for single supply)										
Parameter	Symbol	Test Conditions Unless Otherwise Specified V <sub>+</sub> = 12 V, V <sub>-</sub> = 0 V, WR = 0, RS = 2.4 V, V <sub>IN</sub> = 2.4 V, 0.8 V <sup>f</sup>	Temp. <sup>b</sup>	Typ. <sup>c</sup>	A Suffix - 55°C to 125 °C		D Suffix - 40 °C to 85 °C		Unit	
					Min. <sup>d</sup>	Max. <sup>d</sup>	Min. <sup>d</sup>	Max. <sup>d</sup>		
<b>Analog Switch</b>										
Analog Signal Range <sup>e</sup>	V <sub>ANALOG</sub>		Full		0	12	0	12	V	
Drain-Source On-Resistance	R <sub>DS(on)</sub>	V <sub>D</sub> = ± 10 V, V <sub>AL</sub> = 0.8 V I <sub>S</sub> = - 500 µA, V <sub>AH</sub> = 2.4 V	Room	80		150		150	Ω	
R <sub>DS(on)</sub> Match <sup>g</sup>	ΔR <sub>DS(on)</sub>	0 V < V <sub>S</sub> < 10 V I <sub>S</sub> = - 1 mA	Room	5					%	
Source Off Leakage Current	I <sub>S(off)</sub>	V <sub>S</sub> = 0 V, 10 V, V <sub>EN</sub> = 0 V, V <sub>D</sub> = 10 V, 0 V	Room Full	± 0.03	- 0.5 - 50	0.5 50	- 0.5 - 50	0.5 50	nA	
Drain Off Leakage Current	I <sub>D(off)</sub>	V <sub>D</sub> = 0 V, 10 V V <sub>S</sub> = 10 V, 0 V V <sub>EN</sub> = 0 V	DG428	Room Full	± 0.07	- 1 - 100	1 100	- 1 - 100		1 100
			DG429	Room Full	± 0.05	- 1 - 50	1 50	- 1 - 50		1 50
Drain On Leakage Current	I <sub>D(on)</sub>	V <sub>S</sub> = V <sub>D</sub> = 0 V, 10 V V <sub>EN</sub> = 2.4 V V <sub>AL</sub> = 0.8 V V <sub>AH</sub> = 2.4 V	DG428	Room Full	± 0.07	- 1 - 100	1 100	- 1 - 100	1 100	
			DG429	Room Full	± 0.05	- 1 - 50	1 50	- 1 - 50	1 50	
<b>Digital Control</b>										
Logic Input Current Input Voltage High	I <sub>AH</sub>	V <sub>A</sub> = 2.4 V	Full			1		1	µA	
		V <sub>A</sub> = 12 V	Full			1		1		
Logic Input Current Input Voltage Low	I <sub>AL</sub>	V <sub>EN</sub> = 0 V, 2.4 V, V <sub>A</sub> = 0 V RS = 0 V, WR = 0 V	Full		- 1		- 1			
<b>Dynamic Characteristics</b>										
Transition Time	t <sub>TRANS</sub>	S <sub>1</sub> = 10 V/ 2 V, S <sub>8</sub> = 2 V/ 10 V See Figure 5	Room Full	160		280 350		280 350	ns	
Break-Before-Make Interval	t <sub>OPEN</sub>	See Figure 4	Room Full	40	25 10		25 10			
Enable and Write Turn-On Time	t <sub>ON(EN,WR)</sub>	S <sub>1</sub> = 5 V See Figure 6 and 7	Room Full	110		300 400		300 400		
Enable and Reset Turn-Off Time	t <sub>OFF(EN,RS)</sub>	S <sub>1</sub> = 5 V See Figure 6 and 8	Room Full	70		300 400		300 400		
Charge Injection	Q	V <sub>GEN</sub> = 6 V, R <sub>GEN</sub> = 0 Ω C <sub>L</sub> = 1 nF, See Figure 9	Room	4					pC	
Off Isolation	OIRR	V <sub>EN</sub> = 0 V, R <sub>L</sub> = 300 Ω C <sub>L</sub> = 15 pF, V <sub>S</sub> = 7 V <sub>RMS</sub> f = 100 kHz	Room	- 75					dB	
<b>Minimum Input Timing Requirements</b>										
Write Pulse Width	t <sub>W</sub>	See Figure 2	Full		100		100		ns	
A <sub>X</sub> , EN Data Set Up time	t <sub>S</sub>		Full		100		100			
A <sub>X</sub> , EN Data Hold Time	t <sub>H</sub>		Full		10		10			
Reset Pulse Width	t <sub>RS</sub>		V <sub>S</sub> = 5 V, See Figure 3	Full		100		100		
<b>Power Supplies</b>										
Positive Supply Current	I <sub>+</sub>	V <sub>EN</sub> = 0 V, V <sub>A</sub> = 0, RS = 5 V	Room	20		100		100	µA	

Notes:

- a. Refer to PROCESS OPTION FLOWCHART.
- b. Room = 25 °C, full = as determined by the operating temperature suffix.
- c. Typical values are for DESIGN AID ONLY, not guaranteed nor subject to production testing.
- d. The algebraic convention whereby the most negative value is a minimum and the most positive a maximum, is used in this data sheet.
- e. Guaranteed by design, not subject to production test.
- f. V<sub>IN</sub> = input voltage to perform proper function.

$$g. \Delta R_{DS(on)} = \left( \frac{R_{DS(on) \text{ MAX}} - R_{DS(on) \text{ MIN}}}{R_{DS(on) \text{ AVE}}} \right) \times 100 \%$$

Stresses beyond those listed under "Absolute Maximum Ratings" may cause permanent damage to the device. These are stress ratings only, and functional operation of the device at these or any other conditions beyond those indicated in the operational sections of the specifications is not implied. Exposure to absolute maximum rating conditions for extended periods may affect device reliability.

### TYPICAL CHARACTERISTICS (T<sub>A</sub> = 25 °C, unless otherwise noted)

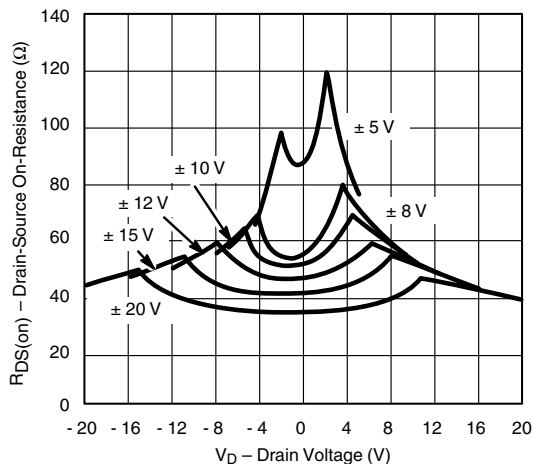

**R<sub>DS(on)</sub> vs. V<sub>D</sub> and Supply Voltage**

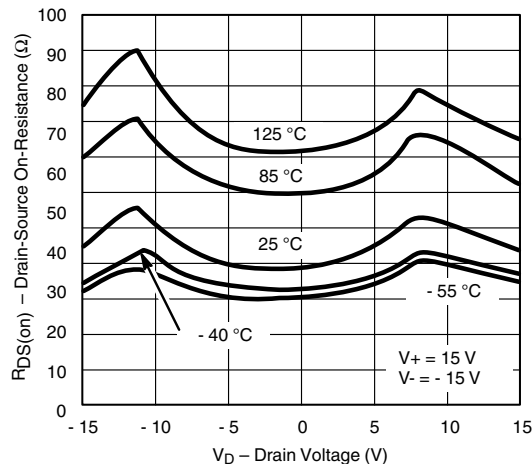

**R<sub>DS(on)</sub> vs. V<sub>D</sub> and Temperature**

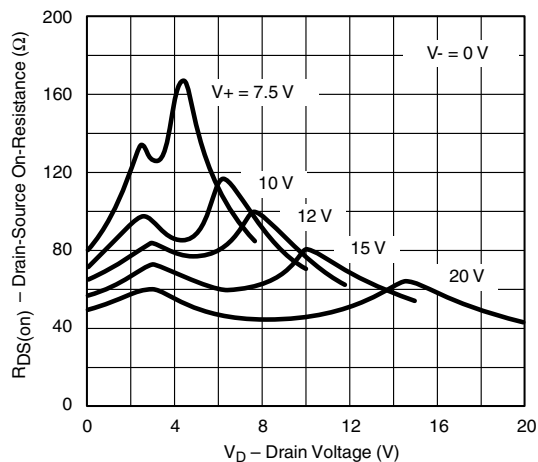

**Single Supply R<sub>DS(on)</sub> vs. V<sub>D</sub> and Supply**

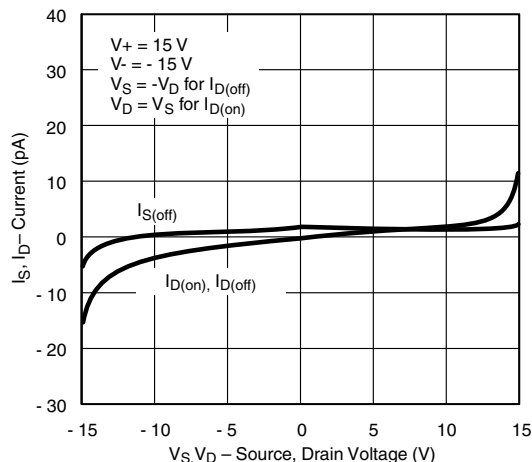

**I<sub>D</sub>, I<sub>S</sub> Leakage Currents vs. Analog Voltage**

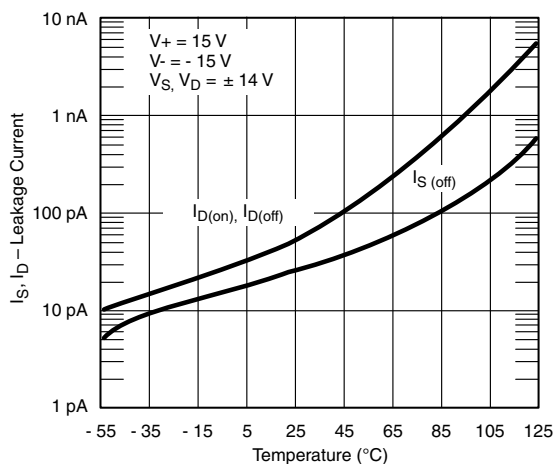

**I<sub>D</sub>, I<sub>S</sub> Leverages vs. Temperature**

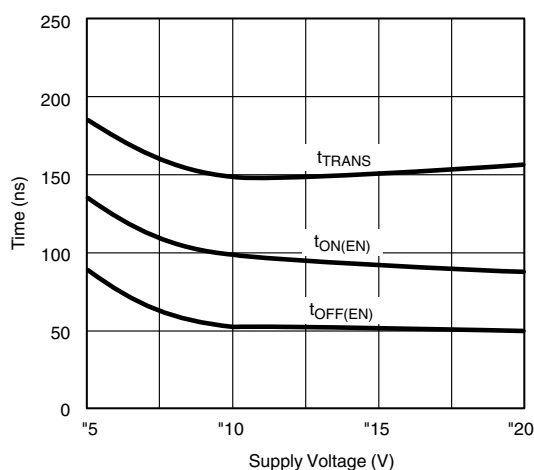

**Switching Times vs. Power Supply Voltage**

**TYPICAL CHARACTERISTICS** ( $T_A = 25\text{ }^\circ\text{C}$ , unless otherwise noted)

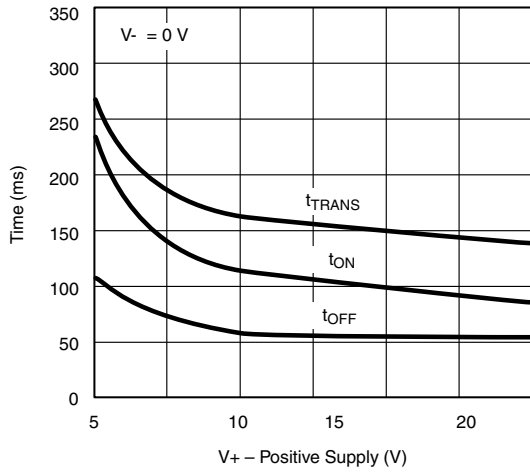

**Switching Times vs. Single Supply**

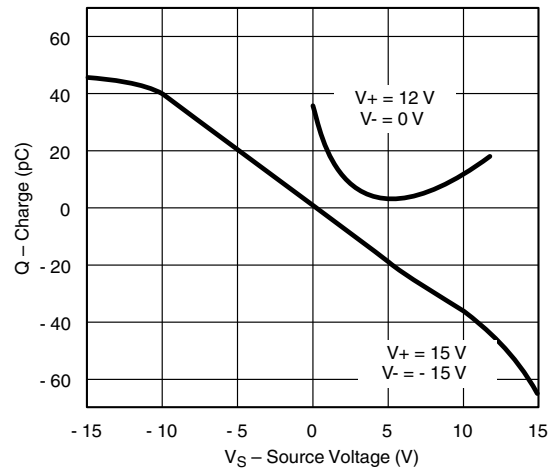

**Charge Injection vs. Analog Voltage**



**Off-Isolation vs. Frequency**

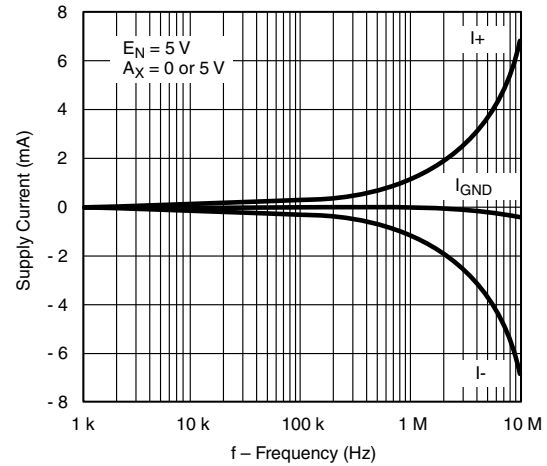

**Supply Currents vs. Switching Frequency**



**Switching Times vs. Temperature**



**Input Switching Threshold vs. Positive Supply Voltage**

## SCHEMATIC DIAGRAM (Typical Channel)



Figure 1.

## TIMING DIAGRAMS



Figure 2.

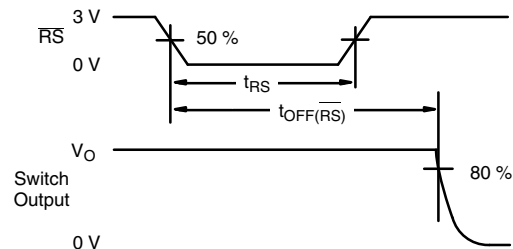

Figure 3.

## TEST CIRCUITS



Figure 4. Break-Before-Make





## TEST CIRCUITS

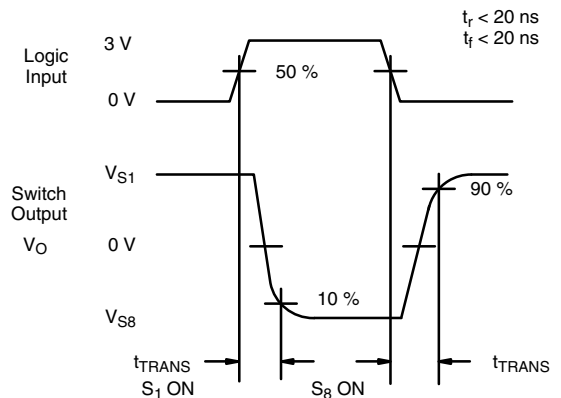

Figure 5. Transition Time

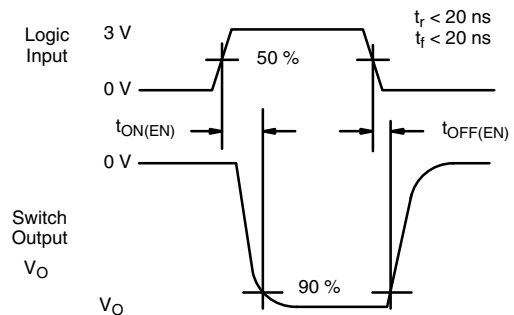
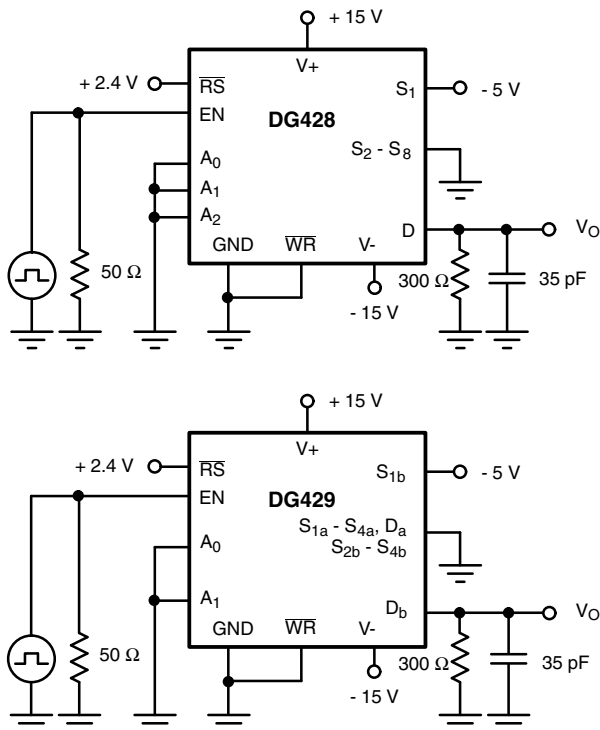

Figure 6. Enable  $t_{ON}/t_{OFF}$  Time

## TEST CIRCUITS



Figure 7. Write Turn-On Time  $t_{ON(WR)}$

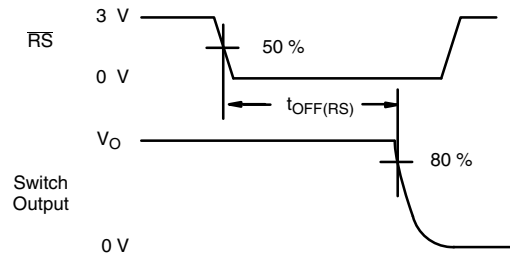
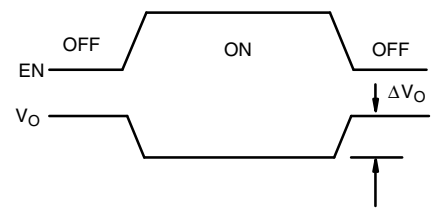

Figure 8. Reset Turn-Off Time  $t_{OFF(RS)}$



$\Delta V_O$  is the measured voltage error due to charge injection. The charge in coulombs is  $Q = C_L \times \Delta V_O$

Figure 9. Charge Injection

## DETAILED DESCRIPTION

The internal structure of the DG428, DG429 includes a 5 V logic interface with input protection circuitry followed by a latch, level shifter, decoder and finally the switch constructed with parallel n- and p-channel MOSFETs (see Figure 1).

The input protection on the logic lines  $A_0$ ,  $A_1$ ,  $A_2$ , EN and control lines  $\overline{WR}$ ,  $\overline{RS}$  shown in Figure 1 minimizes susceptibility to ESD that may be encountered during handling and operational transients.

The logic interface is a CMOS logic input with its supply voltage from an internal + 5 V reference voltage. The output of the input inverter feeds the data input of a D type latch. The level sensitive D latch continuously places the  $D_X$  input signal on the  $Q_X$  output when the  $\overline{WR}$  input is low, resulting in transparent latch operation. As soon as  $\overline{WR}$  returns high the latch holds the data last present on the  $D_n$  input, subject to the "Minimum Input Timing Requirements" table.

Following the latches the  $Q_n$  signals are level shifted and decoded to provide proper drive levels for the CMOS switches. This level shifting ensures full on/off switch operation for any analog signal level between the  $V+$  and  $V-$  supply rails.

The EN pin is used to enable the address latches during the  $\overline{WR}$  pulse. It can be hard wired to the logic supply or to  $V+$  if one of the channels will always be used (except during a reset) or it can be tied to address decoding circuitry for memory mapped operation. The  $\overline{RS}$  pin is used as a master reset. All latches are cleared regardless of the state of any other latch or control line. The  $\overline{WR}$  pin is used to transfer the state of the address control lines to their latches, except during a reset or when EN is low (see Truth Tables).

## APPLICATIONS HINTS

### Bus Interfacing

The DG428, DG429 minimize the amount of interface hardware between a microprocessor system bus and the analog system being controlled or measured. The internal TTL compatible latches give these multiplexers write-only memory, that is, they can be programmed to stay in a particular switch state (e.g., switch 1 on) until the microprocessor determines it is necessary to turn different switches on or turn all switches off (see Figure 10).

The input latches become transparent when  $\overline{WR}$  is held low; therefore, these multiplexers operate by direct command of the coded switch state on  $A_2$ ,  $A_1$ ,  $A_0$ . In this mode the DG428 is identical to the popular DG408. The same is true of the DG429 versus the popular DG409.

During system power-up,  $\overline{RS}$  would be low, maintaining all eight switches in the off state. After  $\overline{RS}$  returned high the DG428 maintains all switches in the off state.

When the system program performs a write operation to the address assigned to the DG428, the address decoder provides a  $\overline{CS}$  active low signal which is gated with the WRITE ( $\overline{WR}$ ) control signal. At this time the data on the DATA BUS (that will determine which switch to close) is stabilizing. When the  $\overline{WR}$  signal returns to the high state, (positive edge) the input latches of the DG428 save the data from the DATA BUS. The coded information in the  $A_0$ ,  $A_1$ ,  $A_2$  and EN latches is decoded and the appropriate switch is turned on.

The EN latch allows all switches to be turned off under program control. This becomes useful when two or more DG428s are cascaded to build 16-line and larger multiplexers.



Figure 10. Bus Interface

Vishay Siliconix maintains worldwide manufacturing capability. Products may be manufactured at one of several qualified locations. Reliability data for Silicon Technology and Package Reliability represent a composite of all qualified locations. For related documents such as package/tape drawings, part marking, and reliability data, see [www.vishay.com/ppg?70063](http://www.vishay.com/ppg?70063).



**PLCC: 20-LEAD**



Dim	MILLIMETERS		INCHES	
	Min	Max	Min	Max
<b>A</b>	4.20	4.57	0.165	0.180
<b>A<sub>1</sub></b>	2.29	3.04	0.090	0.120
<b>A<sub>2</sub></b>	0.51	–	0.020	–
<b>B</b>	0.331	0.553	0.013	0.021
<b>B<sub>1</sub></b>	0.661	0.812	0.026	0.032
<b>D</b>	9.78	10.03	0.385	0.395
<b>D<sub>1</sub></b>	8.890	9.042	0.350	0.356
<b>D<sub>2</sub></b>	7.37	8.38	0.290	0.330
<b>e<sub>1</sub></b>	1.27 BSC		0.050 BSC	

ECN: S-03946—Rev. C, 09-Jul-01  
DWG: 5306



**SOIC (WIDE-BODY): 18-LEAD**



Dim	MILLIMETERS		INCHES	
	Min	Max	Min	Max
A	2.15	2.90	0.085	0.114
A <sub>1</sub>	0.10	0.30	0.004	0.012
B	0.35	0.45	0.014	0.018
C	0.23	0.28	0.009	0.011
D	11.25	12.45	0.443	0.490
E	7.25	8.00	0.285	0.315
e	1.27 BSC		0.050 BSC	
H	9.80	10.60	0.386	0.417
L	0.60	1.00	0.024	0.039
⊖	0°	8°	0°	8°

ECN: S-03946—Rev. C, 09-Jul-01  
DWG: 5302

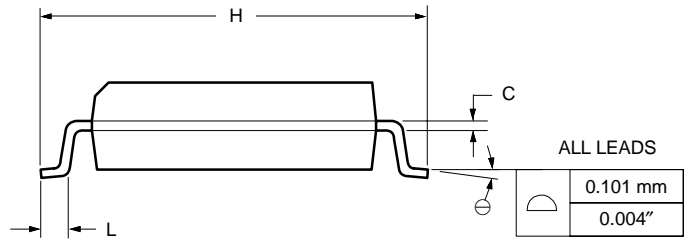



## Disclaimer

ALL PRODUCT, PRODUCT SPECIFICATIONS AND DATA ARE SUBJECT TO CHANGE WITHOUT NOTICE TO IMPROVE RELIABILITY, FUNCTION OR DESIGN OR OTHERWISE.

Vishay Intertechnology, Inc., its affiliates, agents, and employees, and all persons acting on its or their behalf (collectively, "Vishay"), disclaim any and all liability for any errors, inaccuracies or incompleteness contained in any datasheet or in any other disclosure relating to any product.

Vishay makes no warranty, representation or guarantee regarding the suitability of the products for any particular purpose or the continuing production of any product. To the maximum extent permitted by applicable law, Vishay disclaims (i) any and all liability arising out of the application or use of any product, (ii) any and all liability, including without limitation special, consequential or incidental damages, and (iii) any and all implied warranties, including warranties of fitness for particular purpose, non-infringement and merchantability.

Statements regarding the suitability of products for certain types of applications are based on Vishay's knowledge of typical requirements that are often placed on Vishay products in generic applications. Such statements are not binding statements about the suitability of products for a particular application. It is the customer's responsibility to validate that a particular product with the properties described in the product specification is suitable for use in a particular application. Parameters provided in datasheets and/or specifications may vary in different applications and performance may vary over time. All operating parameters, including typical parameters, must be validated for each customer application by the customer's technical experts. Product specifications do not expand or otherwise modify Vishay's terms and conditions of purchase, including but not limited to the warranty expressed therein.

Except as expressly indicated in writing, Vishay products are not designed for use in medical, life-saving, or life-sustaining applications or for any other application in which the failure of the Vishay product could result in personal injury or death. Customers using or selling Vishay products not expressly indicated for use in such applications do so at their own risk. Please contact authorized Vishay personnel to obtain written terms and conditions regarding products designed for such applications.

No license, express or implied, by estoppel or otherwise, to any intellectual property rights is granted by this document or by any conduct of Vishay. Product names and markings noted herein may be trademarks of their respective owners.

## Material Category Policy

**Vishay Intertechnology, Inc. hereby certifies that all its products that are identified as RoHS-Compliant fulfill the definitions and restrictions defined under Directive 2011/65/EU of The European Parliament and of the Council of June 8, 2011 on the restriction of the use of certain hazardous substances in electrical and electronic equipment (EEE) - recast, unless otherwise specified as non-compliant.**

**Please note that some Vishay documentation may still make reference to RoHS Directive 2002/95/EC. We confirm that all the products identified as being compliant to Directive 2002/95/EC conform to Directive 2011/65/EU.**

**Vishay Intertechnology, Inc. hereby certifies that all its products that are identified as Halogen-Free follow Halogen-Free requirements as per JEDEC JS709A standards. Please note that some Vishay documentation may still make reference to the IEC 61249-2-21 definition. We confirm that all the products identified as being compliant to IEC 61249-2-21 conform to JEDEC JS709A standards.**

Компания «Океан Электроники» предлагает заключение долгосрочных отношений при поставках импортных электронных компонентов на взаимовыгодных условиях!

Наши преимущества:

- Поставка оригинальных импортных электронных компонентов напрямую с производств Америки, Европы и Азии, а так же с крупнейших складов мира;
- Широкая линейка поставок активных и пассивных импортных электронных компонентов (более 30 млн. наименований);
- Поставка сложных, дефицитных, либо снятых с производства позиций;
- Оперативные сроки поставки под заказ (от 5 рабочих дней);
- Экспресс доставка в любую точку России;
- Помощь Конструкторского Отдела и консультации квалифицированных инженеров;
- Техническая поддержка проекта, помощь в подборе аналогов, поставка прототипов;
- Поставка электронных компонентов под контролем ВП;
- Система менеджмента качества сертифицирована по Международному стандарту ISO 9001;
- При необходимости вся продукция военного и аэрокосмического назначения проходит испытания и сертификацию в лаборатории (по согласованию с заказчиком);
- Поставка специализированных компонентов военного и аэрокосмического уровня качества (Xilinx, Altera, Analog Devices, Intersil, Interpoint, Microsemi, Actel, Aeroflex, Peregrine, VPT, Syfer, Eurofarad, Texas Instruments, MS Kennedy, Miteq, Cobham, E2V, MA-COM, Hittite, Mini-Circuits, General Dynamics и др.);

Компания «Океан Электроники» является официальным дистрибьютором и эксклюзивным представителем в России одного из крупнейших производителей разъемов военного и аэрокосмического назначения «JONHON», а так же официальным дистрибьютором и эксклюзивным представителем в России производителя высокотехнологичных и надежных решений для передачи СВЧ сигналов «FORSTAR».



## JONHON

«JONHON» (основан в 1970 г.)

Разъемы специального, военного и аэрокосмического назначения:

(Применяются в военной, авиационной, аэрокосмической, морской, железнодорожной, горно- и нефтедобывающей отраслях промышленности)

«FORSTAR» (основан в 1998 г.)

ВЧ соединители, коаксиальные кабели, кабельные сборки и микроволновые компоненты:

(Применяются в телекоммуникациях гражданского и специального назначения, в средствах связи, РЛС, а так же военной, авиационной и аэрокосмической отраслях промышленности).



Телефон: 8 (812) 309-75-97 (многоканальный)

Факс: 8 (812) 320-03-32

Электронная почта: [ocean@oceanchips.ru](mailto:ocean@oceanchips.ru)

Web: <http://oceanchips.ru/>

Адрес: 198099, г. Санкт-Петербург, ул. Калинина, д. 2, корп. 4, лит. А