

DESCRIPTION

The MP62040-1/MP62041-1 Power Distribution Switch is designed for high-side load switch applications. The switch operates from 1.7V to 5.5V nominal input voltage and includes an 85mΩ Power MOSFET to handle up to 2A continuous load.

The MP62040-1/MP62041-1 has slew rate control with 115µs rise time to limit inrush current when enabling the switch. In addition, the part features a discharge function that provides a resistive discharge path for the external output capacitor when the part is disabled.

The built-in level shift function allows a logic signal on enable input that may be different from the supply voltage to switch the high side P-channel MOSFET ON or OFF.

The MP62040-1/MP62041-1 is available in an ultra-small UTQFN4 package, with ultra-low height (0.55mm typ.).

FEATURES

- 2A Continuous Current
- 1.7V to 5.5V Supply Range
- Output Discharge Function
- Soft Start: 115µs
- 1µA Shutdown Current
- 85mΩ MOSFET
- Active High & Active Low Options
- Space Saving 1.6x1.2mm UTQFN4 Package (0.55mm Height)

APPLICATIONS

- Load Switch in Portable Applications
- Battery Switch-over Circuits

For MPS green status, please visit MPS website under Quality Assurance. "MPS" and "The Future of Analog IC Technology" are Registered Trademarks of Monolithic Power Systems, Inc.

TYPICAL APPLICATION

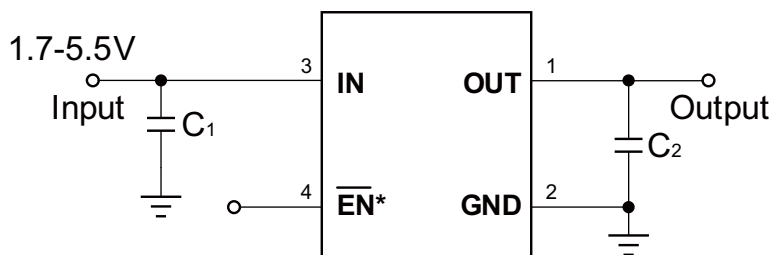

MP62040-1/MP62041-1

(*: EN is active high for MP62041-1)
Single Channel

ORDERING INFORMATION

Part Number	Enable	Switch	Maximum Continuous Load Current	Package	Top Marking	Free Air Temperature (T _A)
MP62040DQFU-1*	Active Low	Single	2A	UTQFN4	AFY	-40°C to +85°C
MP62041DQFU-1	Active High			UTQFN4	5UY	

* For Tape & Reel, add suffix -Z (e.g. MP62040DQFU-1-Z).
 For RoHS compliant packaging, add suffix -LF (e.g. MP62040DQFU-1-LF-Z)

PACKAGE REFERENCE

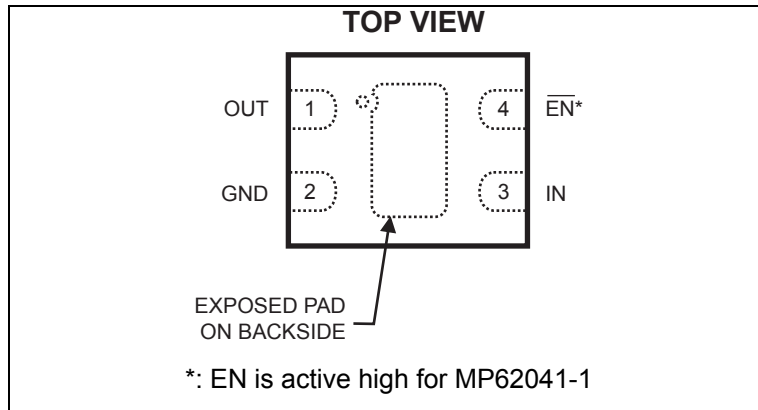

ABSOLUTE MAXIMUM RATINGS ⁽¹⁾

IN	-0.3V to +6.0V
EN, OUT to GND	-0.3V to +6.0V
Continuous Power Dissipation (T _A = +25°C) ⁽²⁾	
UTQFN4.....	0.7W
Junction Temperature.....	150°C
Lead Temperature	260°C
Storage Temperature.....	-65°C to +150°C
Maximum Junction Temp. (T _J).....	+125°C

Thermal Resistance ⁽³⁾	θ_{JA}	θ_{JC}
UTQFN4	173	127.. °C/W

Notes:

- 1) Exceeding these ratings may damage the device.
- 2) The maximum allowable power dissipation is a function of the maximum junction temperature T_J(MAX), the junction-to-ambient thermal resistance θ_{JA}, and the ambient temperature T_A. The maximum allowable continuous power dissipation at any ambient temperature is calculated by P_D(MAX)=(T_J(MAX)-T_A)/θ_{JA}. Exceeding the maximum allowable power dissipation will cause excessive die temperature, and the regulator will go into thermal shutdown. Internal thermal shutdown circuitry protects the device from permanent damage.
- 3) Measured on JESD51-7, 4-layer PCB.

ELECTRICAL CHARACTERISTICS

$V_{IN}=3.6V$, $T_A=+25^{\circ}C$, unless otherwise noted.

Parameter	Symbol	Condition	Min	Typ	Max	Units
IN Voltage Range	V_{IN}		1.7		5.5	V
Supply Current		Device active, $V_{IN}=3.6V$, $I_{OUT}=0$		2		μA
Shutdown Current		Device disable, $V_{IN}=5.5V$, $V_{OUT}=float$			1	μA
FET On_Resistance		$V_{IN}=1.7V$, $I_{OUT}=100mA$		165	225	m Ω
		$V_{IN}=1.8V$, $I_{OUT}=100mA$		155	215	m Ω
		$V_{IN}=2.5V$, $I_{OUT}=100mA$		130	200	m Ω
		$V_{IN}=3.6V$, $I_{OUT}=100mA$		100	140	m Ω
		$V_{IN}=4.5V$, $I_{OUT}=100mA$		85	115	m Ω
EN Input Logic High Voltage		$V_{IN} = 1.7V$ to $4.5V$, $I_D = -250\mu A$	1.2			V
EN Input Logic Low Voltage		$V_{IN} = 1.7V$ to $4.5V$, $I_D = -250\mu A$			0.4	V
EN Input Current		Device active, $V_{IN} = 5.5V$		2	4	μA
Discharge Resistance		Device disable, $V_{IN} = 3.6V$, $I_{TEST} = 1mA$		200	300	Ω
V_{OUT} Rising Time ⁽⁴⁾	T_r	$V_{IN}=3.6V$, $I_{OUT}=100mA$, $C_L=1\mu F$	75	115	200	μs
V_{OUT} Falling Time ⁽⁵⁾	T_f	$V_{IN}=3.6V$, $I_{OUT}=100mA$, $C_L=1\mu F$	65	75	100	μs
Turn On_Time ⁽⁶⁾	T_{on}	$V_{IN}=3.6V$, $I_{OUT}=100mA$, $C_L=1\mu F$		235	350	μs
Turn Off_Time ⁽⁷⁾	T_{off}	$V_{IN}=3.6V$, $I_{OUT}=100mA$, $C_L=1\mu F$		100	200	μs

Notes:

- 4) Measured from 10% to 90%.
- 5) Measured from 90% to 10%.
- 6) Measured from (50%) EN signal to (90%) output signal.
- 7) Measured from (50%) EN signal to (10%) output signal.

PIN FUNCTIONS

UTQFN	Name	Description
1	OUT	IN-to-OUT Power-Distribution Output
2	GND	Ground and the thermal pad should both be connected to electrical ground.
3	IN	Input Voltage. Accepts 1.7V to 5.5V input.
4	$\overline{\text{EN}}$	Active Low: (MP62040-1), Active High: (MP62041-1)

PARAMETER MEASUREMENT INFORMATION

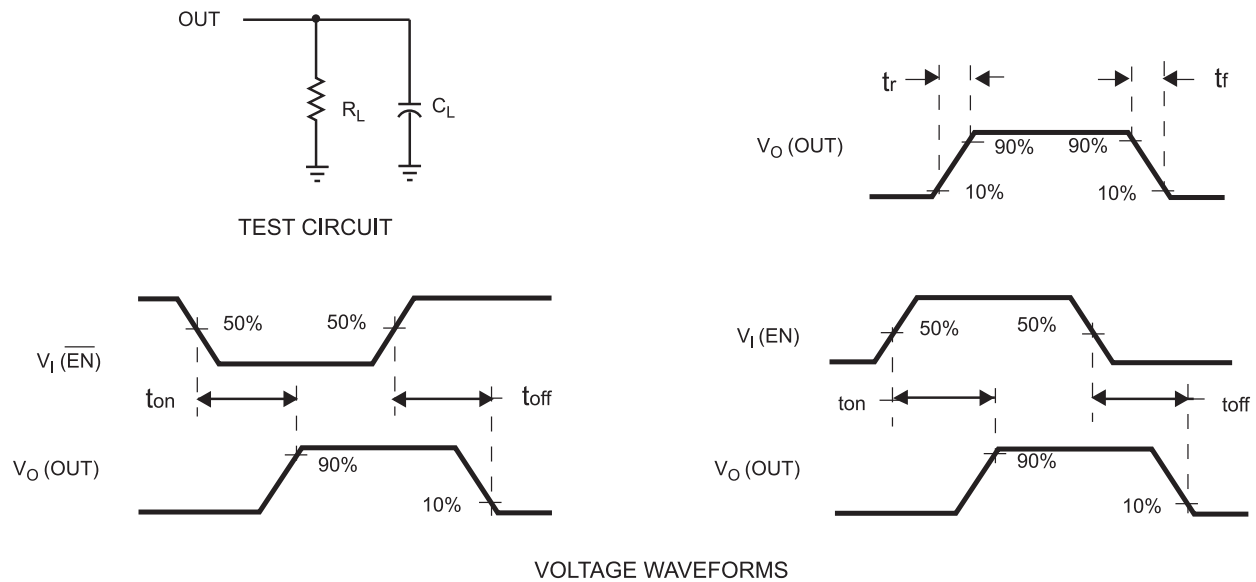
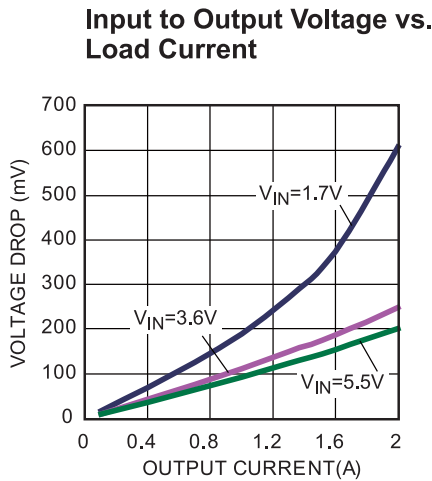
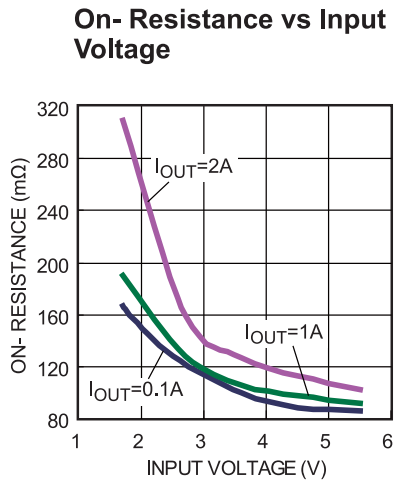
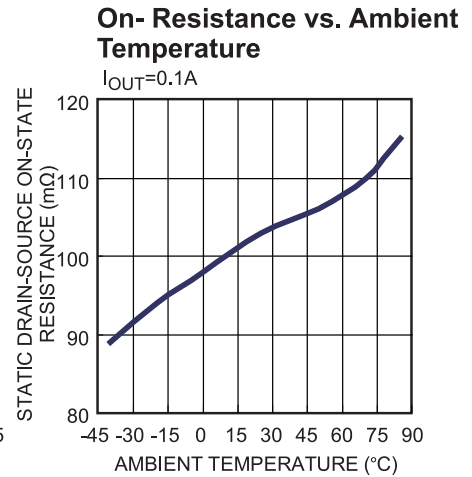
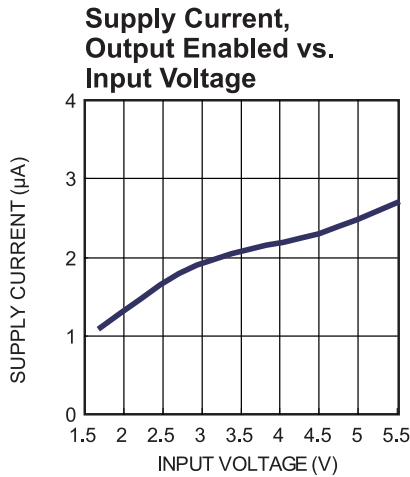
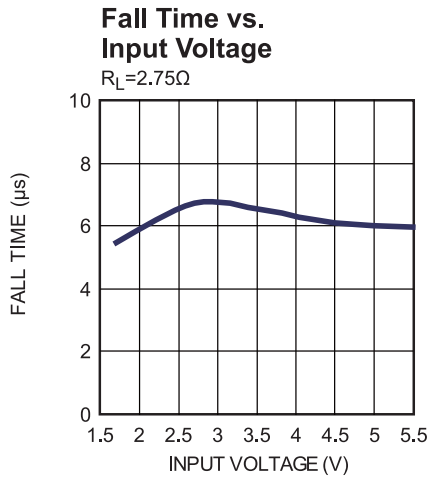
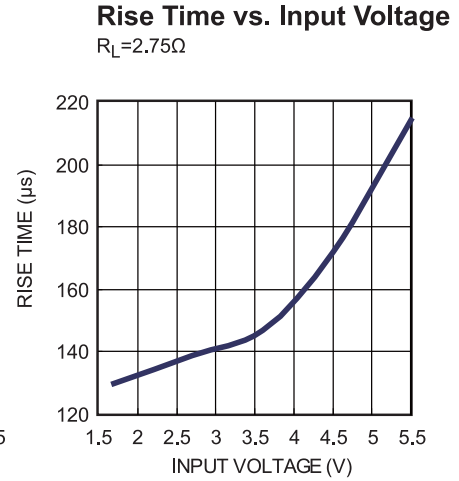
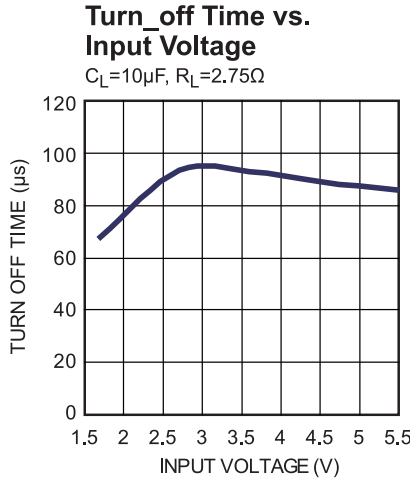
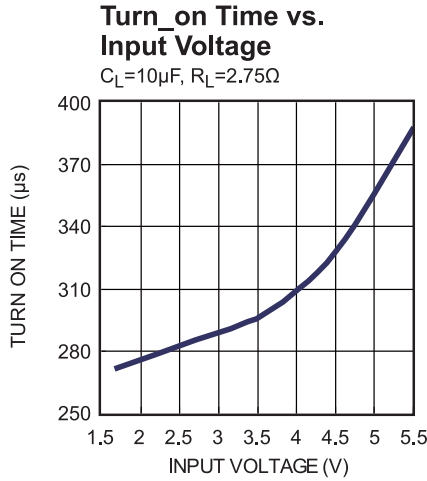

Figure 1 — Definition of Tr, Tf, Ton and Toff

TYPICAL PERFORMANCE CHARACTERISTICS

$V_{IN} = V_{EN} = 3.6V$, $C_L = 1\mu F$, $T_A = +25^\circ C$, unless otherwise noted.

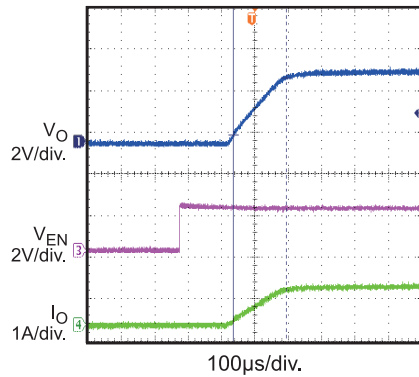
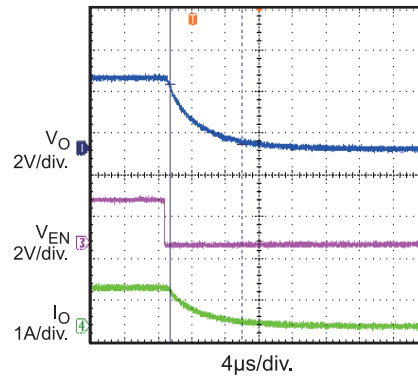
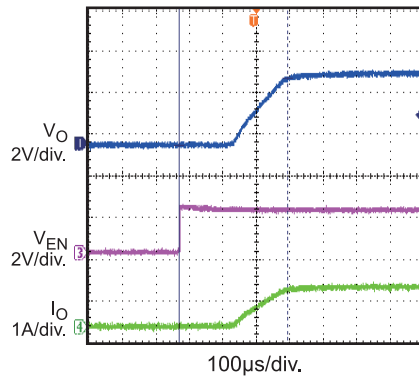
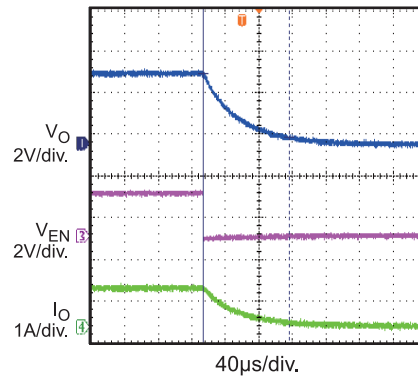

TYPICAL PERFORMANCE CHARACTERISTICS *(continued)*
 $V_{IN} = V_{EN} = 3.6V$, $C_L = 1\mu F$, $T_A = +25^\circ C$, unless otherwise noted.

**Turn_on Delay and Rise Time
with 1 μF Load**
 $R_L = 3.6\Omega$

**Turn_off Delay and Fall Time
with 1 μF Load**
 $R_L = 3.6\Omega$

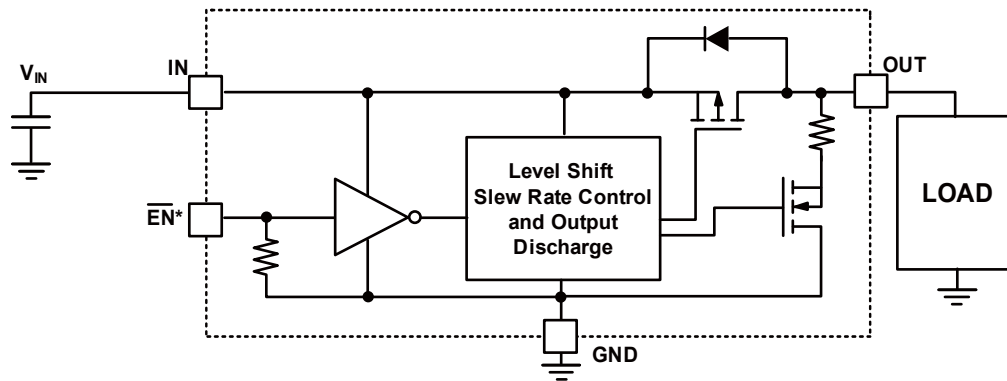
**Turn_on Delay and Rise Time
with 10 μF Load**
 $C_{OUT} = 10\mu F$, $R_L = 3.6\Omega$

**Turn_off Delay and Fall Time
with 10 μF Load**
 $C_{OUT} = 10\mu F$, $R_L = 3.6\Omega$

FUNCTION BLOCK DIAGRAM



(*: EN is active high for MP62041-1)

Figure 2—Function Block Diagram

DETAILED DESCRIPTION

The MP62040-1/MP62041-1 Power Distribution Switch is designed for high-side load switch. The switch operates from 1.7V to 5.5V nominal input voltage and can handle up to 2A continuous load.

Enable

The logic pin disables the switch to reduce overall supply current. Once the EN pin reaches logic enable threshold, the MP62040-1/MP62041-1 is enabled and the supply current is very small, only 2 μ A.

Output Discharge

The part includes a discharge function that provides a resistive discharge path for the external output capacitor. This function allows the device to quickly discharge the output voltage when it's disabled.

APPLICATION INFORMATION

Power-Supply Considerations

Over 10 μ F capacitor between IN and GND is recommended. This precaution reduces power-supply transients that may cause ringing on the input.

In order to achieve smaller output load transient ripple, placing a high-value electrolytic capacitor on the output pin(s) is recommended when the load is heavy.

PACKAGE INFORMATION

UTQFN (1.6x1.2mm)

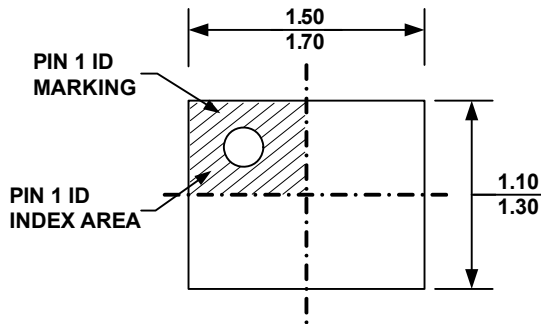

TOP VIEW

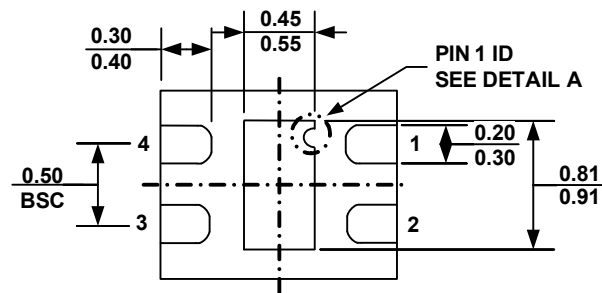

BOTTOM VIEW

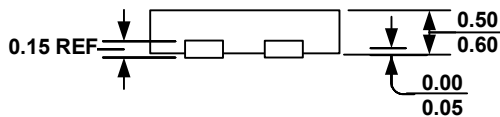

SIDE VIEW

PIN 1 ID OPTION A
R 0.10 TYP.

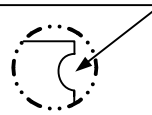

PIN 1 ID OPTION B
0.20x45° TYP.

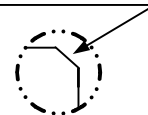

DETAIL A

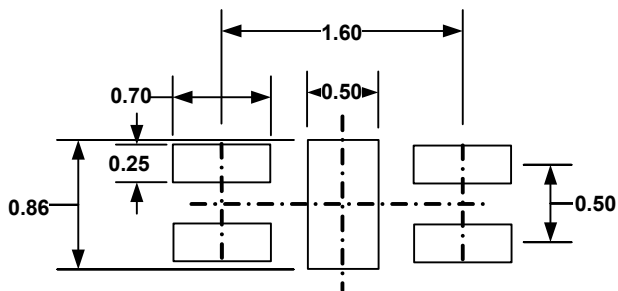

RECOMMENDED LAND PATTERN

NOTE:

- 1) ALL DIMENSIONS ARE IN MILLIMETERS
- 2) EXPOSED PADDLE SIZE DOES NOT INCLUDE MOLD FLASH
- 3) LEAD COPLANARITY SHALL BE 0.10 MILLIMETER MAX
- 4) JEDEC REFERENCE IS MO-229.
- 5) DRAWING IS NOT TO SCALE

NOTICE: The information in this document is subject to change without notice. Users should warrant and guarantee that third party Intellectual Property rights are not infringed upon when integrating MPS products into any application. MPS will not assume any legal responsibility for any said applications.

Компания «Океан Электроники» предлагает заключение долгосрочных отношений при поставках импортных электронных компонентов на взаимовыгодных условиях!

Наши преимущества:

- Поставка оригинальных импортных электронных компонентов напрямую с производств Америки, Европы и Азии, а так же с крупнейших складов мира;
- Широкая линейка поставок активных и пассивных импортных электронных компонентов (более 30 млн. наименований);
- Поставка сложных, дефицитных, либо снятых с производства позиций;
- Оперативные сроки поставки под заказ (от 5 рабочих дней);
- Экспресс доставка в любую точку России;
- Помощь Конструкторского Отдела и консультации квалифицированных инженеров;
- Техническая поддержка проекта, помощь в подборе аналогов, поставка прототипов;
- Поставка электронных компонентов под контролем ВП;
- Система менеджмента качества сертифицирована по Международному стандарту ISO 9001;
- При необходимости вся продукция военного и аэрокосмического назначения проходит испытания и сертификацию в лаборатории (по согласованию с заказчиком);
- Поставка специализированных компонентов военного и аэрокосмического уровня качества (Xilinx, Altera, Analog Devices, Intersil, Interpoint, Microsemi, Actel, Aeroflex, Peregrine, VPT, Syfer, Eurofarad, Texas Instruments, MS Kennedy, Miteq, Cobham, E2V, MA-COM, Hittite, Mini-Circuits, General Dynamics и др.);

Компания «Океан Электроники» является официальным дистрибьютором и эксклюзивным представителем в России одного из крупнейших производителей разъемов военного и аэрокосмического назначения «JONHON», а так же официальным дистрибьютором и эксклюзивным представителем в России производителя высокотехнологичных и надежных решений для передачи СВЧ сигналов «FORSTAR».



JONHON

«JONHON» (основан в 1970 г.)

Разъемы специального, военного и аэрокосмического назначения:

(Применяются в военной, авиационной, аэрокосмической, морской, железнодорожной, горно- и нефтедобывающей отраслях промышленности)

«FORSTAR» (основан в 1998 г.)

ВЧ соединители, коаксиальные кабели, кабельные сборки и микроволновые компоненты:

(Применяются в телекоммуникациях гражданского и специального назначения, в средствах связи, РЛС, а так же военной, авиационной и аэрокосмической отраслях промышленности).



Телефон: 8 (812) 309-75-97 (многоканальный)

Факс: 8 (812) 320-03-32

Электронная почта: ocean@oceanchips.ru

Web: <http://oceanchips.ru/>

Адрес: 198099, г. Санкт-Петербург, ул. Калинина, д. 2, корп. 4, лит. А