

## 3-MODE 150mA LDO REGULATOR with the Reverse Current Protection

NO.EA-118-0605

### OUTLINE

The R1163x Series consist of CMOS-based voltage regulator ICs with high output voltage accuracy and low supply current. These ICs perform with the chip enable function and realize a standby mode with ultra low supply current. To prevent the destruction by over current, the current limit circuit is included. The R1163x Series have 3-mode. One is standby mode with CE or standby control pin. Other two modes are realized with ECO pin™. Fast Transient Mode (FT mode) and Low Power Mode (LP mode) are alternative with ECO pin™. Consumption current is reduced at Low Power Mode compared with Fast Transient Mode. The output voltage is maintained between FT mode and LP mode.

Further, the reverse current protection circuit is built-in. Therefore, if a higher voltage than  $V_{DD}$  pin is forced to the output pin, the reverse current to  $V_{DD}$  pin is very small (Max.  $0.1\mu A$ ), so it is suitable for backup circuit.

Since the packages for these ICs are SOT-23-5, thin SON-6, and PLP1616-6 packages, high density mounting of the ICs on boards is possible.

### FEATURES

- Ultra-Low Supply Current..... Typ.  $6.0\mu A$  (Low Power Mode),  
Typ.  $70\mu A$  (Fast Transient Mode)
- Standby Mode ..... Typ.  $0.6\mu A$
- Reverse Current..... Max.  $0.1\mu A$
- Low Dropout Voltage..... Typ.  $0.25V$  ( $I_{OUT}=150mA$  Output Voltage= $3.0V$  Type)
- High Ripple Rejection ..... Typ.  $70dB$  ( $f=1kHz$ , FT Mode)
- Low Temperature-Drift Coefficient of Output Voltage Typ.  $\pm 100ppm/^{\circ}C$
- Excellent Line Regulation ..... Typ.  $0.02\%/V$
- High Output Voltage Accuracy .....  $\pm 1.5\%$  ( $\pm 2.5\%$  at LP Mode)
- Small Package ..... SOT-23-5 (Super Mini-mold), SON-6, PLP1616-6
- Output Voltage ..... Stepwise setting with a step of  $0.1V$   
in the range of  $1.5V$  to  $4.0V$  is possible
- Built-in fold-back protection circuit ..... Typ.  $40mA$  (Current at short mode)
- Performs with Ceramic Capacitors .....  $C_{IN}=1.0\mu F, C_{OUT}=\text{Ceramic } 0.47\mu F$

### APPLICATIONS

- Precision Voltage References.
- Power source for electrical appliances such as cameras, VCRs and hand-held communication equipment.
- Power source for battery-powered equipment.

**BLOCK DIAGRAM**

**R1163xxx1B**



**R1163xxx1D**



**R1163xxx1E**



## SELECTION GUIDE

The output voltage, the auto-discharge function, the package and the taping type for the ICs can be selected at the user's request. The selection can be available by designating the part number as shown below;

R1163xx1x-xx ←Part Number  
 ↑ ↑ ↑ ↑  
 a b c d

Code	Contents
a	Designation of Package Type : N: SOT-23-5 (Mini-mold) D: SON-6 K: PLP1616-6
b	Setting Output Voltage ( $V_{OUT}$ ) : Stepwise setting with a step of 0.1V in the range of 1.5V to 4.0V is possible. New options: 2.85V type: R1163x281x5-xx, 1.85V type: R1163x181x5-xx, 2.75V E version type: R1163x271E5-xx.
c	Designation of Chip Enable Option : B: "H" active type and without the auto-discharge function. D: "H" active and with the auto-discharge function. E: "H" active type and without auto-discharge function. ECO logic reverse type (Low Power mode at ECO="H")
d	Designation of Taping Type : Refer to Taping Specifications;TR type is the standard direction.

## PIN CONFIGURATIONS

SOT-23-5

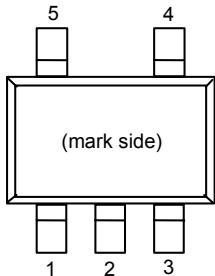

SON-6

Top View



Bottom View

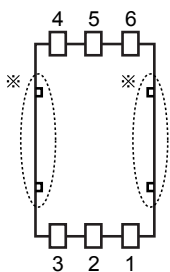

PLP1616-6

Top View

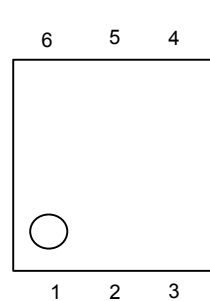

Bottom View

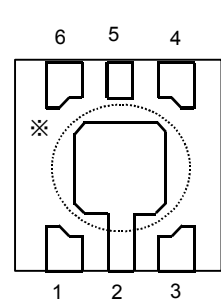

## PIN DISCRIPTIONS

### • SOT-23-5

Pin No	Symbol	Pin Description
1	V <sub>DD</sub>	Input Pin
2	GND	Ground Pin
3	CE	Chip Enable Pin
4	ECO	MODE alternative pin
5	V <sub>OUT</sub>	Output pin

### SON-6

Pin No	Symbol	Pin Description
1	V <sub>DD</sub>	Input Pin
2	NC	No Connection
3	V <sub>OUT</sub>	Output pin
4	ECO	MODE alternative pin
5	GND	Ground Pin
6	CE	Chip Enable Pin

\* Tab in the  parts have GND level.  
(They are connected to the reverse side of this IC.)  
Do not connect to other wires or land patterns.

### • PLP1616-6

Pin No	Symbol	Pin Description
1	V <sub>OUT</sub>	Output pin
2	GND	Ground Pin
3	ECO	MODE alternative pin
4	CE	Chip Enable pin
5	NC	No Connection
6	V <sub>DD</sub>	Input Pin

\* Tab in the  parts have GND level.  
(They are connected to the reverse side of this IC.)  
Do not connect to other wires or land patterns.

## ABSOLUTE MAXIMUM RATINGS

Symbol	Item	Rating	Unit
$V_{IN}$	Input Voltage	6.5	V
$V_{ECO}$	Input Voltage (ECO Pin)	-0.3 ~ 6.5	V
$V_{CE}$	Input Voltage (CE Pin)	-0.3 ~ 6.5	V
$V_{OUT}$	Output Voltage	-0.3 ~ 6.5	V
$I_{OUT}$	Output Current	180	mA
$P_D$	Power Dissipation (SOT-23-5) *	420	mW
	Power Dissipation (SON-6) *	500	
	Power Dissipation (PLP1616-6)*	560	
$T_{opt}$	Operating Temperature Range	-40 ~ 85	°C
$T_{stg}$	Storage Temperature Range	-55 ~ 125	°C

\* ) For Power Dissipation, please refer to PACKAGE INFORMATION to be described.

## ELECTRICAL CHARACTERISTICS

R1163xxx1B/D

T<sub>opt</sub>=25°C

Symbol	Item	Conditions	Min.	Typ.	Max.	Unit
V <sub>OUT</sub>	Output Voltage	V <sub>IN</sub> =Set V <sub>OUT</sub> +1V, V <sub>ECO</sub> =V <sub>IN</sub> 1mA ≤ I <sub>OUT</sub> ≤ 30mA	×0.985		×1.015	V
		V <sub>IN</sub> =Set V <sub>OUT</sub> +1V, V <sub>ECO</sub> =GND 1mA ≤ I <sub>OUT</sub> ≤ 30mA	×0.975		×1.025	
ΔV <sub>OUT</sub>	Output Voltage Deviation between FT Mode and LP Mode	V <sub>IN</sub> =Set V <sub>OUT</sub> +1V, I <sub>OUT</sub> =30mA V <sub>OUT</sub> ≥ 2.0V	-1.2	0.0	1.2	%
		V <sub>OUT</sub> ≤ 2.0V	-24	0	+24	mV
I <sub>OUT</sub>	Output Current	V <sub>IN</sub> -V <sub>OUT</sub> =1.0V	150			mA
ΔV <sub>OUT</sub> / ΔI <sub>OUT</sub>	Load Regulation(FT Mode)	V <sub>IN</sub> =Set V <sub>OUT</sub> +1V, V <sub>ECO</sub> =V <sub>IN</sub> 1mA ≤ I <sub>OUT</sub> ≤ 150mA		20	40	mV
	Load Regulation(LP Mode)	V <sub>IN</sub> =Set V <sub>OUT</sub> +1V, V <sub>ECO</sub> =GND 1mA ≤ I <sub>OUT</sub> ≤ 150mA		10	45	
V <sub>DIF</sub>	Dropout Voltage	Refer to the ELECTRICAL CHARACTERISTICS by OUTPUT VOLTAGE				
I <sub>SS1</sub>	Supply Current(FT Mode)	V <sub>IN</sub> =Set V <sub>OUT</sub> +1V V <sub>ECO</sub> =V <sub>IN</sub> , I <sub>OUT</sub> =0mA		70	100	μA
I <sub>SS2</sub>	Supply Current(LP Mode)	V <sub>IN</sub> =Set V <sub>OUT</sub> +1V V <sub>ECO</sub> =GND, I <sub>OUT</sub> =0mA		6.0	10.0	μA
I <sub>standby</sub>	Supply Current (Standby)	V <sub>IN</sub> =Set V <sub>OUT</sub> +1V, V <sub>CE</sub> = GND V <sub>ECO</sub> =GND		0.4	1.0	μA
ΔV <sub>OUT</sub> / ΔV <sub>IN</sub>	Line Regulation(FT Mode)	Set V <sub>OUT</sub> +0.5V ≤ V <sub>IN</sub> ≤ 6.0V I <sub>OUT</sub> =30mA, V <sub>ECO</sub> =V <sub>IN</sub>		0.02	0.10	%V
	Line Regulation(LP Mode)	Set V <sub>OUT</sub> +0.5V ≤ V <sub>IN</sub> ≤ 6.0V I <sub>OUT</sub> =30mA, V <sub>ECO</sub> =GND		0.05	0.20	
RR	Ripple Rejection(FT Mode)	f=1kHz f=10kHz, Ripple 0.2Vp-p, V <sub>IN</sub> =Set V <sub>OUT</sub> +1V I <sub>OUT</sub> = 30mA, V <sub>ECO</sub> = V <sub>IN</sub> If V <sub>OUT</sub> ≤ 1.7V, then V <sub>IN</sub> = Set V <sub>OUT</sub> +1V		70 60		dB
V <sub>IN</sub>	Input Voltage		2.0		6.0	V
ΔV <sub>OUT</sub> / ΔT	Output Voltage Temperature Coefficient	I <sub>OUT</sub> =30mA -40°C ≤ T <sub>opt</sub> ≤ 85°C		±100		ppm /°C
I <sub>LIM</sub>	Short Current Limit	V <sub>OUT</sub> =0V		40		mA
I <sub>PD</sub>	CE Pull-down Constant Current			0.3	0.6	μA
R <sub>PD</sub>	ECO Pull-down Resistance		2	5	30	MΩ
V <sub>CEH</sub>	CE, ECO Input Voltage "H"		1.0		6.0	V
V <sub>CEL</sub>	CE, ECO Input Voltage "L"		0.0		0.4	V
en	Output Noise "H" (FT Mode)	BW=10Hz to 100kHz		30		μVrms
	Output Noise "L" (LP Mode)	BW=10Hz to 100kHz		40		
R <sub>LOW</sub>	Nch Tr. On Resistance for auto-discharge function (Applied only to D version)	V <sub>CE</sub> =0V		60		Ω
I <sub>REV</sub>	Reverse Current	V <sub>OUT</sub> >.5V, 0V ≤ V <sub>IN</sub> ≤ 6V		0.0	0.1	μA

## R1163xxx1E

T<sub>opt</sub>=25°C

Symbol	Item	Conditions	Min.	Typ.	Max.	Unit
V <sub>OUT</sub>	Output Voltage	V <sub>IN</sub> = Set V <sub>OUT</sub> +1V V <sub>ECO</sub> =GND 1mA ≤ I <sub>OUT</sub> ≤ 30mA	V <sub>OUT</sub> ×0.985		V <sub>OUT</sub> ×1.015	V
		V <sub>IN</sub> = Set V <sub>OUT</sub> +1V V <sub>ECO</sub> =V <sub>IN</sub> 1mA ≤ I <sub>OUT</sub> ≤ 30mA	V <sub>OUT</sub> ×0.975		V <sub>OUT</sub> ×1.025	
ΔV <sub>OUT</sub>	Output Voltage Deviation between FT Mode and LP Mode	V <sub>IN</sub> = Set V <sub>OUT</sub> +1V, I <sub>OUT</sub> =30mA V <sub>OUT</sub> ≥ 2.0V	-1.2	0.0	1.2	%
		V <sub>OUT</sub> ≤ 2.0V	-24	0	+24	mV
I <sub>OUT</sub>	Output Current	V <sub>IN</sub> - V <sub>OUT</sub> = 1.0V	150			mA
ΔV <sub>OUT</sub> / ΔI <sub>OUT</sub>	Load Regulation (FT Mode)	V <sub>IN</sub> = Set V <sub>OUT</sub> +1V, V <sub>ECO</sub> =GND 1mA ≤ I <sub>OUT</sub> ≤ 150mA		20	40	mV
	Load Regulation (LP Mode)	V <sub>IN</sub> = Set V <sub>OUT</sub> +1V, V <sub>ECO</sub> =V <sub>IN</sub> 1mA ≤ I <sub>OUT</sub> ≤ 150mA		20	45	
V <sub>DIF</sub>	Dropout Voltage	Refer to the ELECTRICAL CHARACTERISTICS by OUTPUT VOLTAGE				
I <sub>SS1</sub>	Supply Current (FT Mode)	V <sub>IN</sub> = Set V <sub>OUT</sub> +1V V <sub>ECO</sub> = GND, I <sub>OUT</sub> =0mA		70	100	μA
I <sub>SS2</sub>	Supply Current (LP Mode)	V <sub>IN</sub> = Set V <sub>OUT</sub> +1V V <sub>ECO</sub> = V <sub>IN</sub> , I <sub>OUT</sub> =0mA		6.0	10.0	μA
I <sub>standby</sub>	Supply Current (Standby)	V <sub>IN</sub> = Set V <sub>OUT</sub> +1V, V <sub>CE</sub> = GND V <sub>ECO</sub> =GND		0.6	1.0	μA
ΔV <sub>OUT</sub> / ΔV <sub>IN</sub>	Line Regulation (FT Mode)	Set V <sub>OUT</sub> +0.5V ≤ V <sub>IN</sub> ≤ 6.0V I <sub>OUT</sub> = 30mA, V <sub>ECO</sub> = GND		0.02	0.10	%V
	Line Regulation (LP Mode)	Set V <sub>OUT</sub> +0.5V ≤ V <sub>IN</sub> ≤ 6.0V I <sub>OUT</sub> = 30mA, V <sub>ECO</sub> = V <sub>IN</sub>		0.05	0.20	
RR	Ripple Rejection (FT Mode)	f = 1kHz f = 10kHz, Ripple 0.2Vp-p V <sub>IN</sub> = Set V <sub>OUT</sub> +1V I <sub>OUT</sub> = 30mA, V <sub>ECO</sub> = GND If V <sub>OUT</sub> ≤ 1.7V, then V <sub>IN</sub> = Set V <sub>OUT</sub> +1V		70 60		dB
V <sub>IN</sub>	Input Voltage		2.0		6.0	V
ΔV <sub>OUT</sub> / ΔT	Output Voltage Temperature Coefficient	I <sub>OUT</sub> = 30mA -40°C ≤ T <sub>opt</sub> ≤ 85°C		±100		ppm /°C
I <sub>LIM</sub>	Short Current Limit	V <sub>OUT</sub> = 0V		40		mA
I <sub>PD</sub>	CE Pull-down Constant Current			0.3	0.6	μA
V <sub>CEH</sub>	CE, ECO Input Voltage "H"		1.0		6.0	V
V <sub>CEL</sub>	CE, ECO Input Voltage "L"		0.0		0.4	V
en	Output Noise "H" (FT Mode)	BW = 10Hz to 100kHz		30		μVrms
	Output Noise "L" (LP Mode)	BW = 10Hz to 100kHz		40		
I <sub>REV</sub>	Reverse Current	V <sub>OUT</sub> >0.5V, 0V ≤ V <sub>IN</sub> ≤ 6V		0.0	0.1	μA

## ELECTRICAL CHARACTERISTICS by OUTPUT VOLTAGE

Topt = 25°C

Output Voltage $V_{OUT}$ (V)	Dropout Voltage (V)				
	Condition	$V_{DIF}(ECO=H)$		$V_{DIF}(ECO=L)$	
		Typ.	Max.	Typ.	Max.
$1.5 \leq V_{OUT} < 1.6$	$I_{OUT} = 150\text{mA}$	0.400	0.680	0.420	0.680
$1.6 \leq V_{OUT} < 1.7$		0.380	0.550	0.390	0.550
$1.7 \leq V_{OUT} < 1.8$		0.350	0.520	0.370	0.520
$1.8 \leq V_{OUT} < 2.0$		0.340	0.490	0.350	0.490
$2.0 \leq V_{OUT} < 2.8$		0.290	0.425	0.300	0.425
$2.8 \leq V_{OUT} \leq 4.0$		0.250	0.350	0.250	0.350

## TECHNICAL NOTES

When using these ICs, consider the following points:

### Phase Compensation

In these ICs, phase compensation is made for securing stable operation even if the load current is varied. For this purpose, be sure to use a  $0.47\mu\text{F}$  or more ceramic capacitor  $C_{OUT}$ .

(Test these ICs with as same external components as ones to be used on the PCB.)

When a tantalum capacitor is used with this IC, if the equivalent series resistor (ESR) of the capacitor is large, output voltage may be unstable.

### PCB Layout

Make  $V_{DD}$  and GND lines sufficient. If their impedance is high, noise pickup or unstable operation may result. Connect a capacitor with as much as  $1.0\mu\text{F}$  capacitor between  $V_{DD}$  and GND pin as close as possible.

Set external components such as an output capacitor, as close as possible to the ICs and make wiring as short as possible.

## TYPICAL APPLICATION

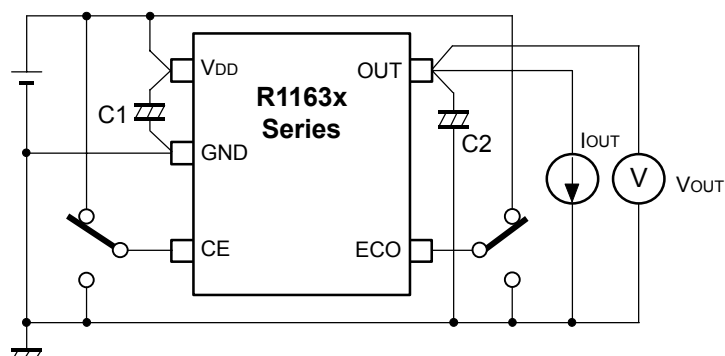

\*External Components

Ex. : C1: Ceramic Capacitor  $1.0\mu\text{F}$

C2 : Ceramic Capacitor  $0.47\mu\text{F}$  (Murata GRM40B474K)



## TYPICAL CHARACTERISTICS

Unless otherwise provided, capacitors are ceramic type.

### 1) Output Voltage vs. Output Current

**R1163x151x ECO=H**



**R1163x151x ECO=L**



**R1163x281x ECO=H**



**R1163x281x ECO=L**



**R1163x40x ECO=H**



**R1163x40x ECO=L**



2) Output Voltage vs. Input Voltage

R1163x151x ECO=H



R1163x15x ECO=L



R1163x28x ECO=H



R1163x28x ECO=L



R1163x40x ECO=H



R1163x40x ECO=L



### 3) Supply Current vs. Input Voltage

**R1163x151x ECO=H**



**R1163x151x ECO=L**

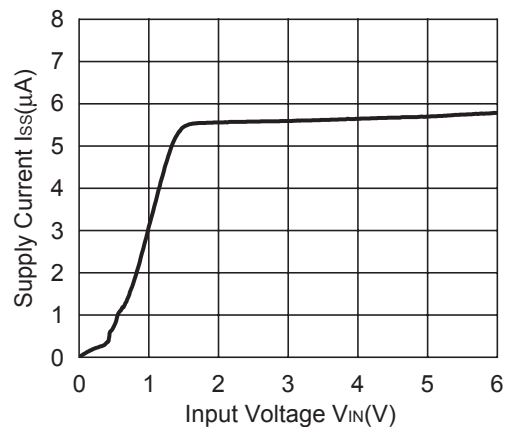

**R1163x281x ECO=H**



**R1163x281x ECO=L**

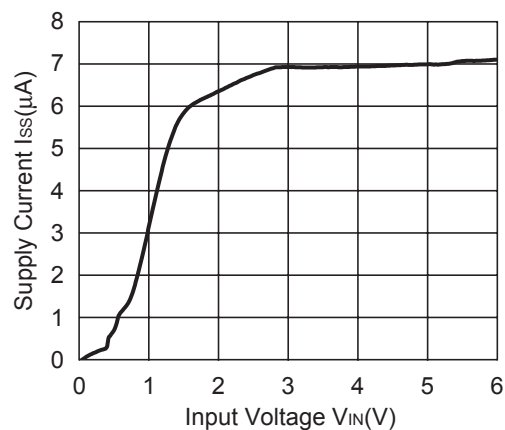

**R1163x401x ECO=H**

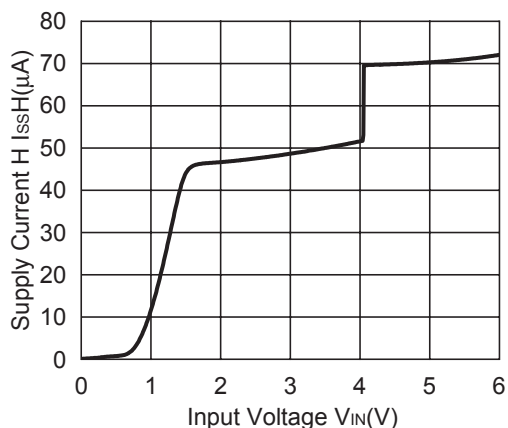

**R1163x401x ECO=L**

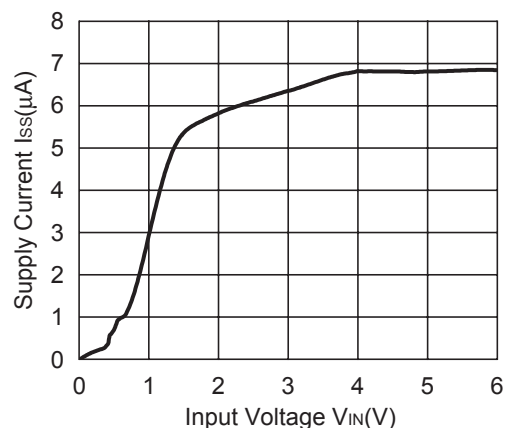

4) Output Voltage vs. Temperature

R1163x151x ECO=H



R1163x151x ECO=L



R1163x281x ECO=H



R1163x281x ECO=L



R1163x401x ECO=H



R1163x401x ECO=L



5) Supply Current vs. Temperature

R1163x151x ECO=H



R1163x151x ECO=L



R1163x281x ECO=H



R1163x281x ECO=L



R1163x401x ECO=H



R1163x401x ECO=L



6) Standby Current vs. Input Voltage



7) Reverse Current vs. Output Voltage

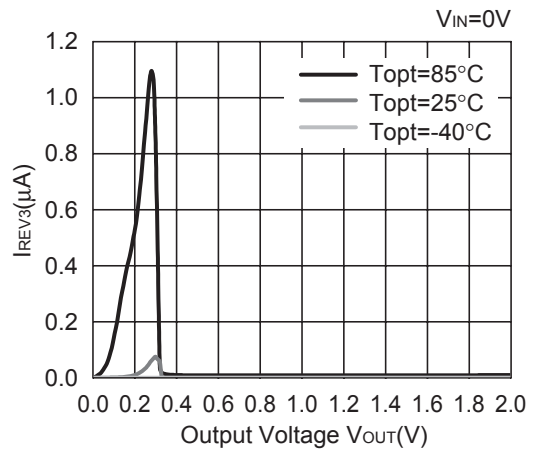

8) Dropout Voltage vs. Output Current

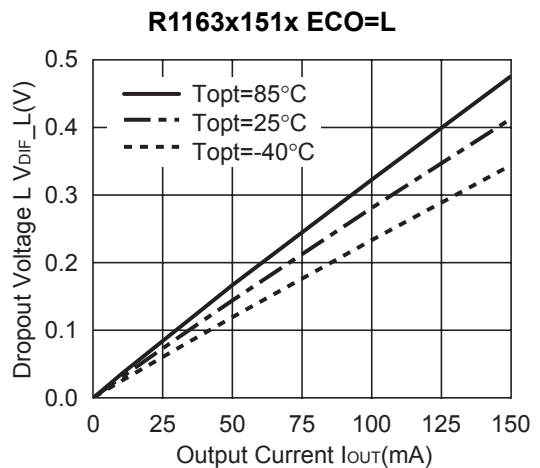
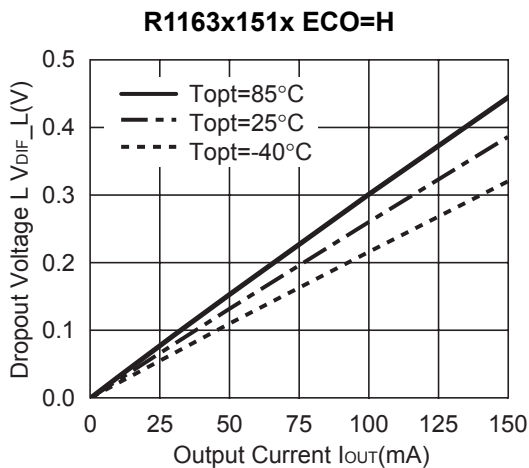

R1163x161x ECO=H



R1163x161x ECO=L

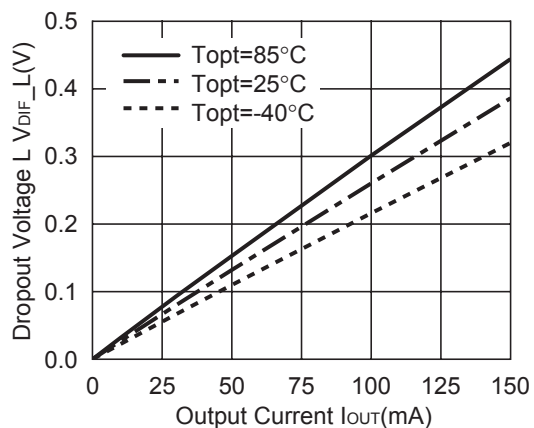

R1163x171x ECO=H



R1163x171x ECO=L

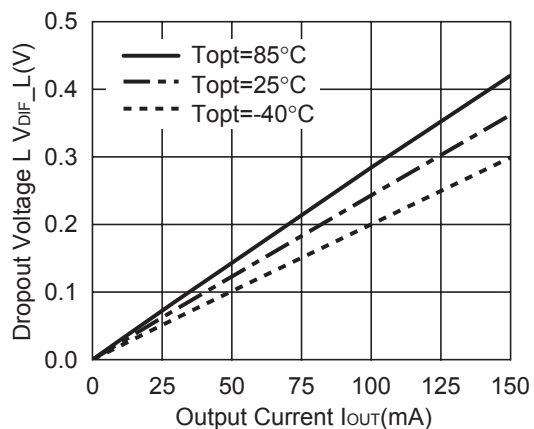

R1163x181x ECO=H



R1163x181x ECO=L

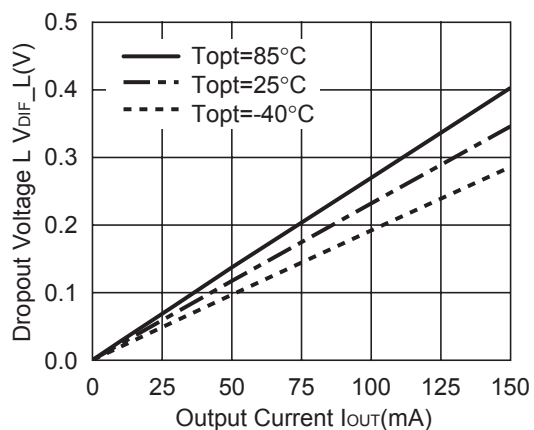

R1163x211x ECO=H

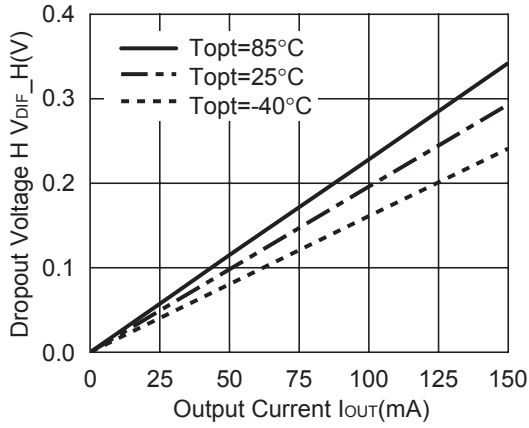

R1163x211x ECO=L

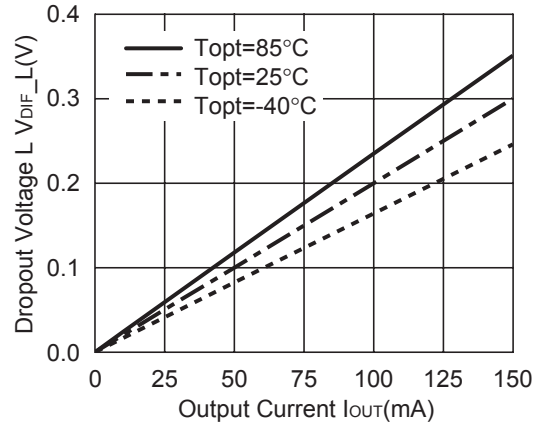

R1163x281x ECO=H

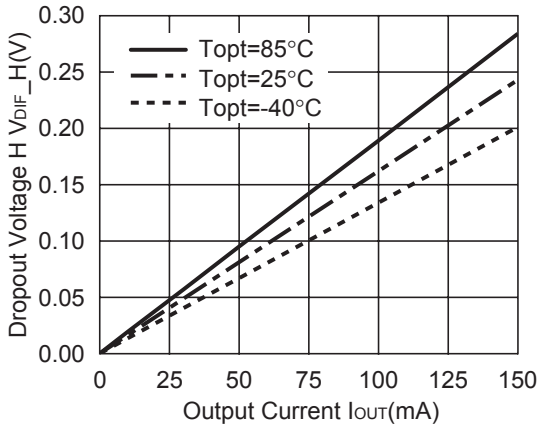

R1163x281x ECO=L

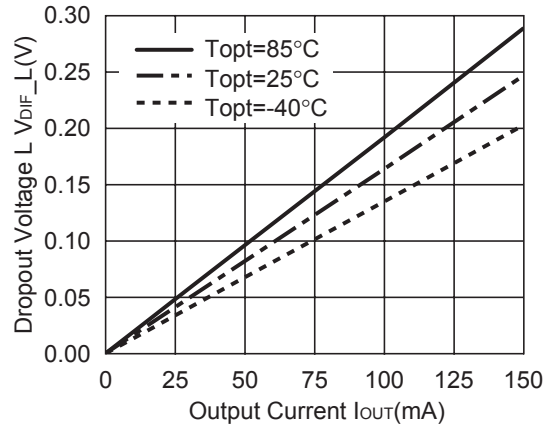

R1163x401x ECO=H

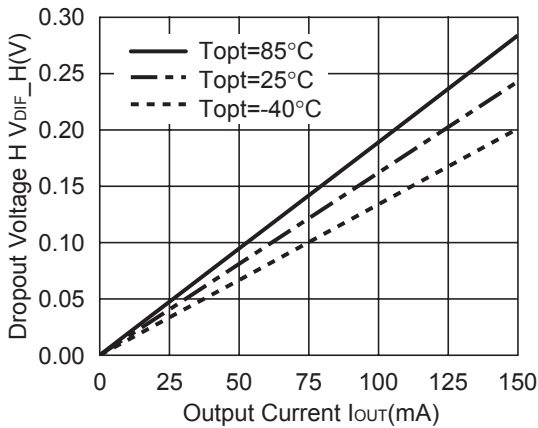

R1163x401x ECO=L

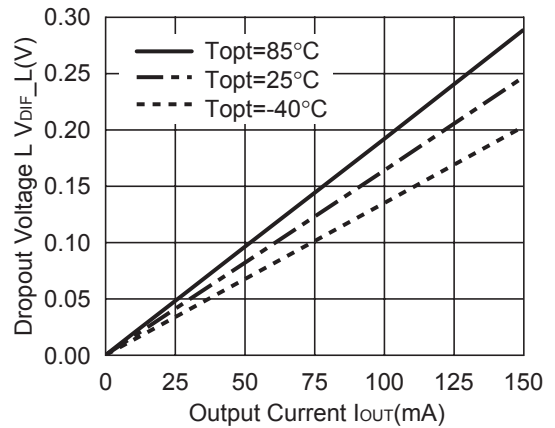



9) Dropout Voltage vs. Set Output Voltage

R1163x ECO=H



R1163x ECO=L



10) Ripple Rejection vs. Input Bias Voltage

R1163x281x ECO=H

$C_{IN}$ =none,  $C_{OUT}$ =0.47 $\mu$ F,  
 $I_{OUT}$ =1mA Ripple=0.2Vp-p



R1163x281x ECO=L

$C_{IN}$ =none,  $C_{OUT}$ =0.47 $\mu$ F,  
 $I_{OUT}$ =1mA Ripple=0.5Vp-p



R1162x281x ECO=H

$C_{IN}$ =none,  $C_{OUT}$ =0.47 $\mu$ F,  
 $I_{OUT}$ =30mA Ripple=0.2Vp-p



R1162x281x ECO=L

$C_{IN}$ =none,  $C_{OUT}$ =0.47 $\mu$ F,  
 $I_{OUT}$ =30mA Ripple=0.5Vp-p



**R1163x281x ECO=H**

$C_{IN}$ =none,  $C_{OUT}$ =0.47 $\mu$ F,  
 $I_{OUT}$ =50mA Ripple=0.2Vp-p



**R1163x281x ECO=H**

$C_{IN}$ =none,  $C_{OUT}$ =0.47 $\mu$ F,  
 $I_{OUT}$ =50mA Ripple=0.5Vp-p

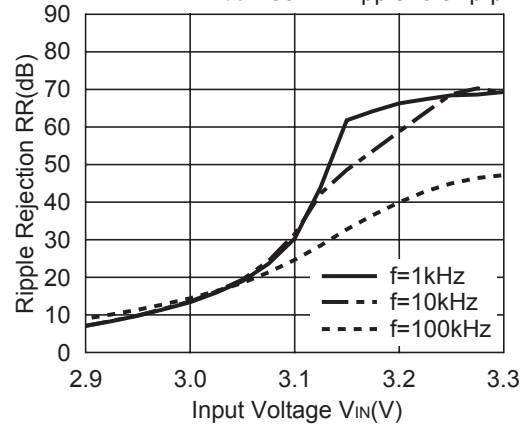

**11) Ripple Rejection vs. Frequency( $C_{IN}$ =none)**

**R1163x151x ECO=H**

$C_{IN}$ =none,  $C_{OUT}$ =0.47 $\mu$ F,  
 $V_{IN}$ =2.5V $_{DC}$ +0.2Vp-p



**R1163x151x ECO=L**

$C_{IN}$ =none,  $C_{OUT}$ =0.47 $\mu$ F,  
 $V_{IN}$ =2.5V $_{DC}$ +0.2Vp-p

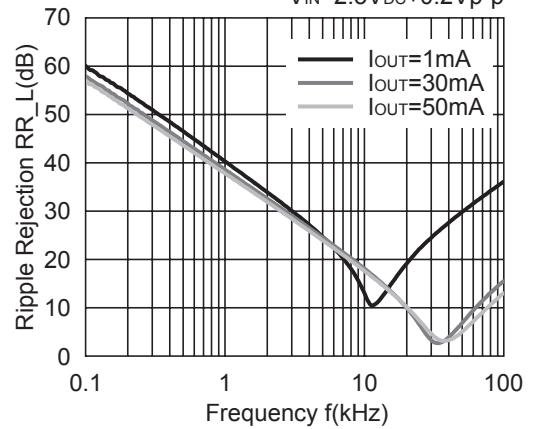

**R1163x281x ECO=H**

$C_{IN}$ =none,  $C_{OUT}$ =0.47 $\mu$ F,  
 $V_{IN}$ =3.8V $_{DC}$ +0.2Vp-p



**R1163x281x ECO=L**

$C_{IN}$ =none,  $C_{OUT}$ =0.47 $\mu$ F,  
 $V_{IN}$ =3.8V $_{DC}$ +0.2Vp-p

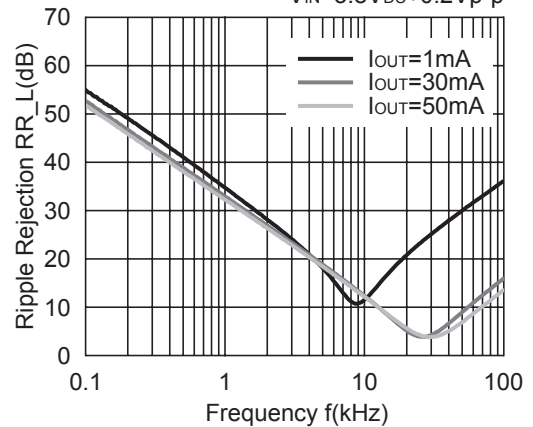

**R1163x401x ECO=H**

$C_{IN}$ =none,  $C_{OUT}$ =0.47 $\mu$ F,  
 $V_{IN}$ =5.0V<sub>DC</sub>+0.2V<sub>p-p</sub>



**R1163x401x ECO=L**

$C_{IN}$ =none,  $C_{OUT}$ =0.47 $\mu$ F,  
 $V_{IN}$ =5.0V<sub>DC</sub>+0.2V<sub>p-p</sub>



**12) Input Transient Response**

**R1163x151x ECO=H**

$C_{IN}$ =none,  $C_{OUT}$ =0.47 $\mu$ F  $I_{OUT}$ =30mA



**R1163x151x ECO=L**

$C_{IN}$ =none,  $C_{OUT}$ =0.47 $\mu$ F  $I_{OUT}$ =10mA



**R1163x151x ECO=L**

$C_{IN}$ =none,  $C_{OUT}$ =1 $\mu$ F  $I_{OUT}$ =10mA



**R1163x281x ECO=H**

$C_{IN}$ =none,  $C_{OUT}$ =1 $\mu$ F  $I_{OUT}$ =30mA



**R1163x281x ECO=H**

$C_{IN}$ =none,  $C_{OUT}$ =1 $\mu$ F  $I_{OUT}$ =10mA



**13) Load Transient Response**

**R1163x151x ECO=H**

$V_{IN}$ =2.5V,  $C_{IN}$ =1 $\mu$ F  $C_{OUT}$ =0.47 $\mu$ F



**R1163x151x ECO=H**

$V_{IN}$ =2.5V,  $C_{IN}$ =1 $\mu$ F  $C_{OUT}$ =1.0 $\mu$ F



**R1163x151x ECO=H**

$V_{IN}$ =2.5V,  $C_{IN}$ =1 $\mu$ F  $C_{OUT}$ =0.47 $\mu$ F



**R1163x151x ECO=H**

$V_{IN}$ =2.5V,  $C_{IN}$ =1 $\mu$ F  $C_{OUT}$ =1.0 $\mu$ F



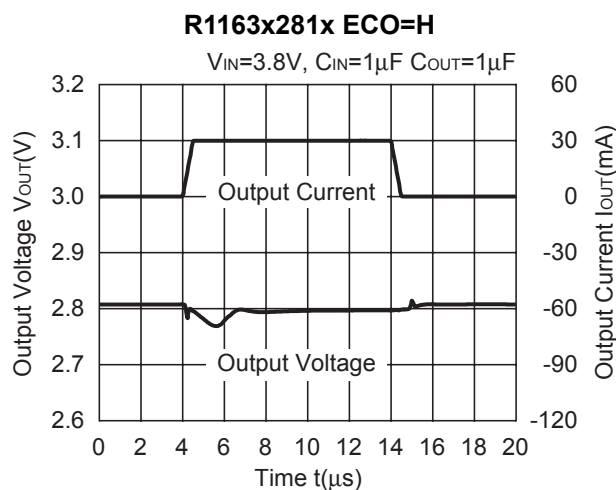
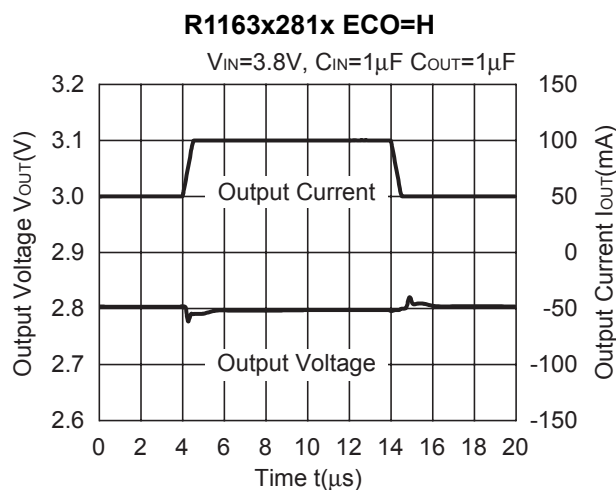

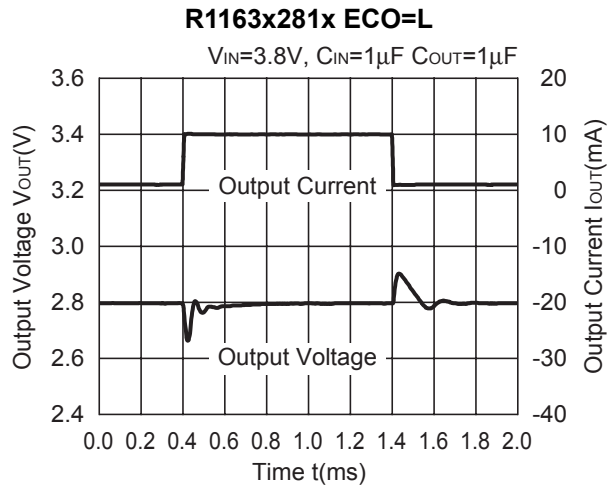

14) Turn on speed with CE pin

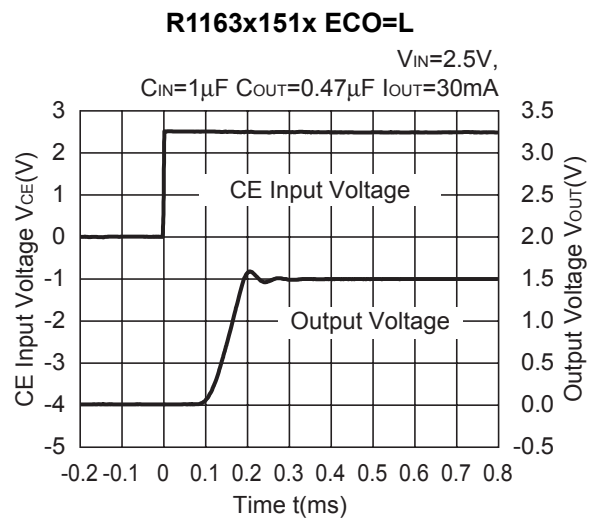
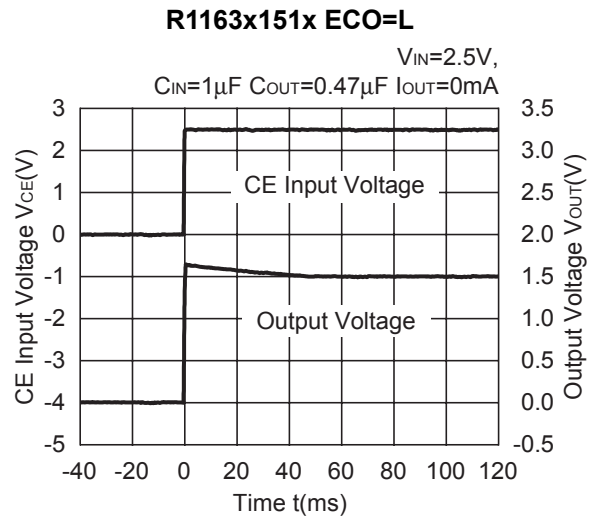

**R1163x151x ECO=H**

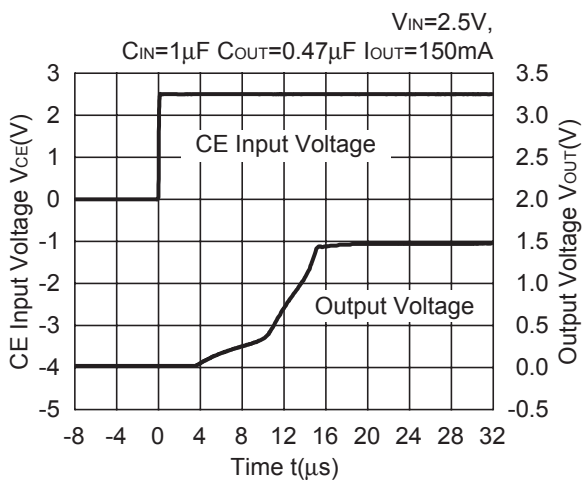

**R1163x151x ECO=L**



**R1163x281x ECO=H**



**R1163x281x ECO=L**



**R1163x281x ECO=H**



**R1163x281x ECO=L**



**R1163x281x ECO=H**



**R1163x281x ECO=L**



**R1163x401x ECO=H**



**R1163x401x ECO=L**



**R1163x401x ECO=H**



**R1163x401x ECO=L**

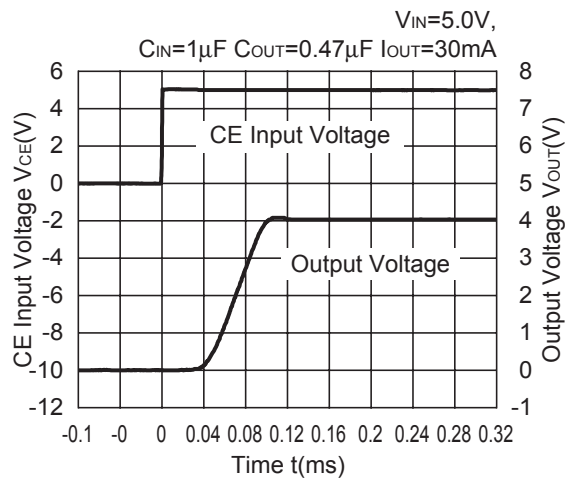



**R1163x401x ECO=H**



**R1163x401x ECO=L**



**15) Turn off speed with CE pin**

**R1163x151xD**



**R1163x281xD**



**R1163x401xD**



16) Output Voltage at Mode alternative point

R1163x151B/D

$V_{IN}=2.5V$ ,  $C_{IN}$ =Ceramic  $1.0\mu F$ ,  
 $C_{OUT}$ =Ceramic  $0.47\mu F$

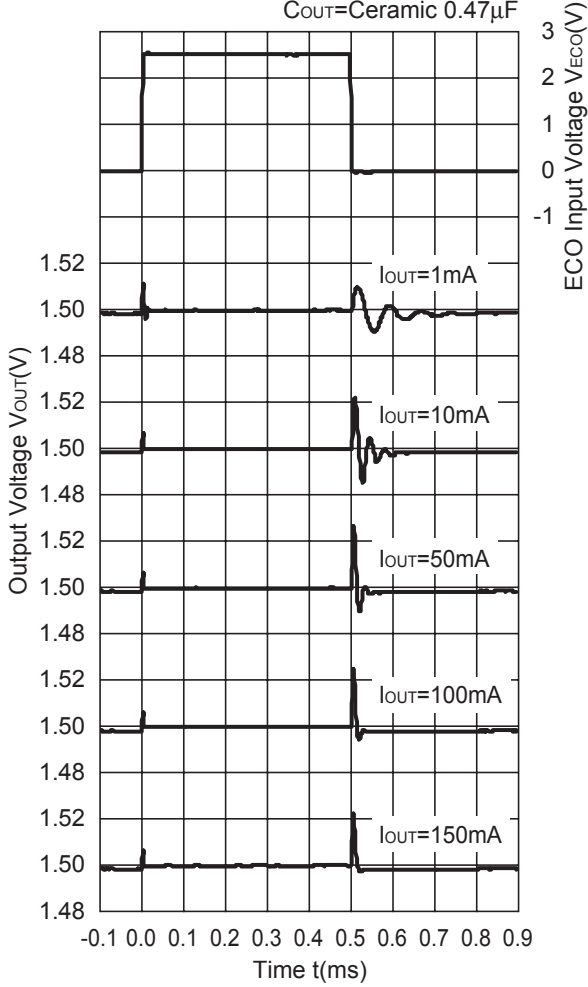

R1163x281B/D

$V_{IN}=3.8V$ ,  $C_{IN}$ =Ceramic  $1.0\mu F$ ,  
 $C_{OUT}$ =Ceramic  $0.47\mu F$

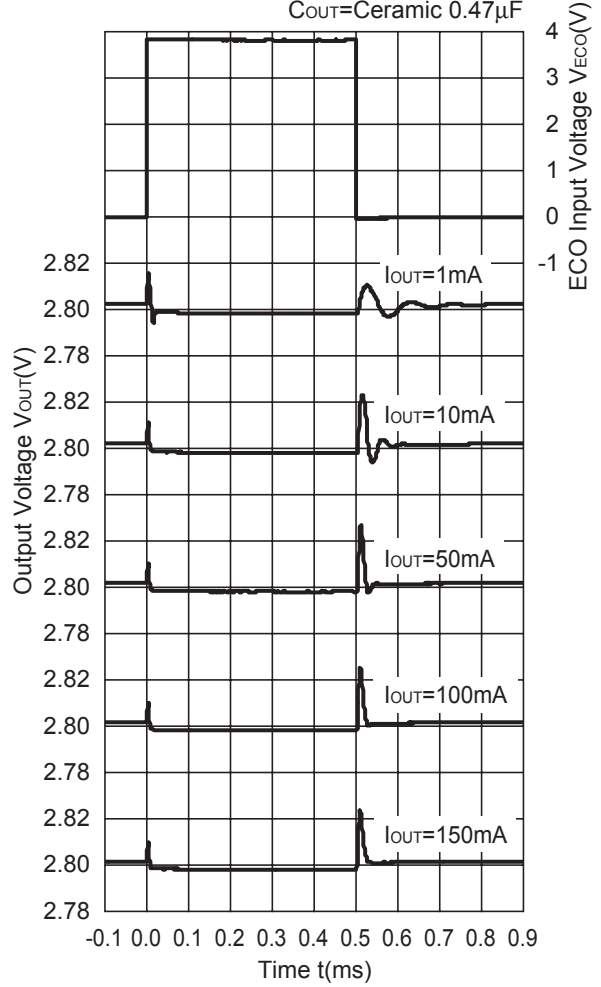

## TECHNICAL NOTES

When using these ICs, consider the following points:

In these ICs, phase compensation is made for securing stable operation even if the load current is varied. For this purpose, be sure to use a capacitor  $C_{OUT}$  with good frequency characteristics and ESR (Equivalent Series Resistance) in the range described as follows:

The relations between  $I_{OUT}$  (Output Current) and ESR of Output Capacitor are shown below. The conditions when the white noise level is under  $40\mu\text{V}$  (Avg.) are marked as the hatched area in the graph.

### <Test conditions>

#### (1) Frequency band: 10Hz to 2MHz



- SOT-23-5 (SC-74A)

Unit: mm

PACKAGE DIMENSIONS

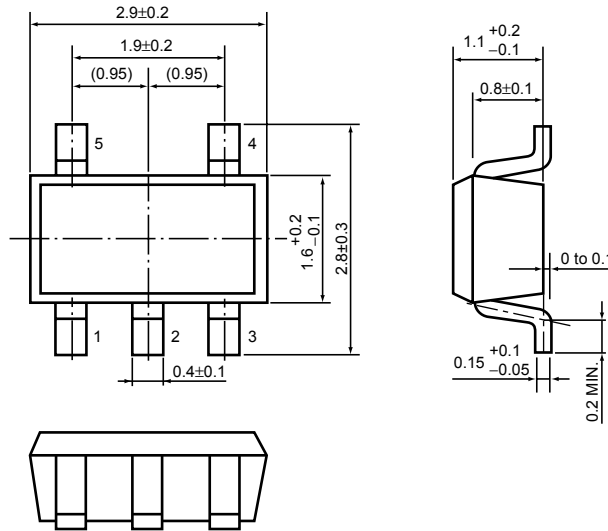

TAPING SPECIFICATION

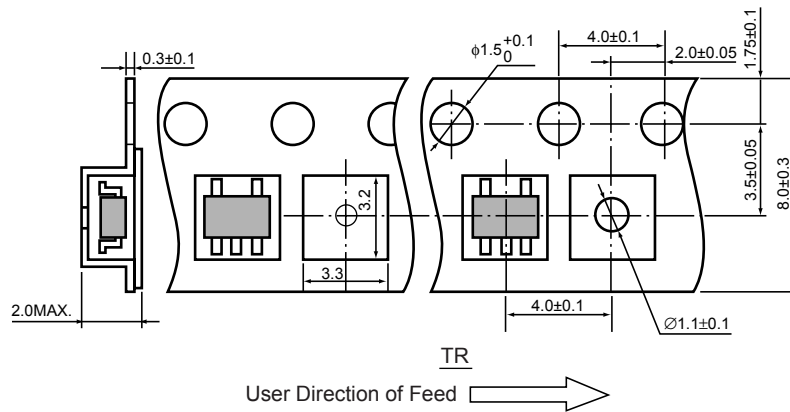

TAPING REEL DIMENSIONS

(1reel=3000pcs)

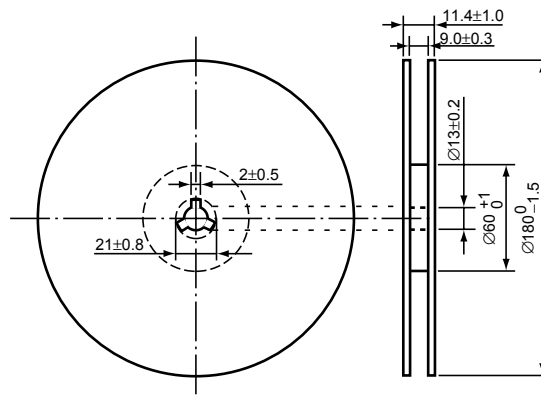

## POWER DISSIPATION (SOT-23-5)

This specification is at mounted on board. Power Dissipation ( $P_D$ ) depends on conditions of mounting on board.

This specification is based on the measurement at the condition below:

(Power Dissipation (SOT-23-5) is substitution of SOT-23-6.)

### Measurement Conditions

	Standard Land Pattern
Environment	Mounting on Board (Wind velocity=0m/s)
Board Material	Glass cloth epoxy plactic (Double sided)
Board Dimensions	40mm × 40mm × 1.6mm
Copper Ratio	Top side : Approx. 50% , Back side : Approx. 50%
Through-hole	φ0.5mm × 44pcs

### Measurement Result

( $T_{opt}=25^{\circ}C, T_{jmax}=125^{\circ}C$ )

	Standard Land Pattern	Free Air
Power Dissipation	420mW	250mW
Thermal Resistance	$\theta_{ja}=(125-25^{\circ}C)/0.42W=263^{\circ}C/W$	400 $^{\circ}C/W$

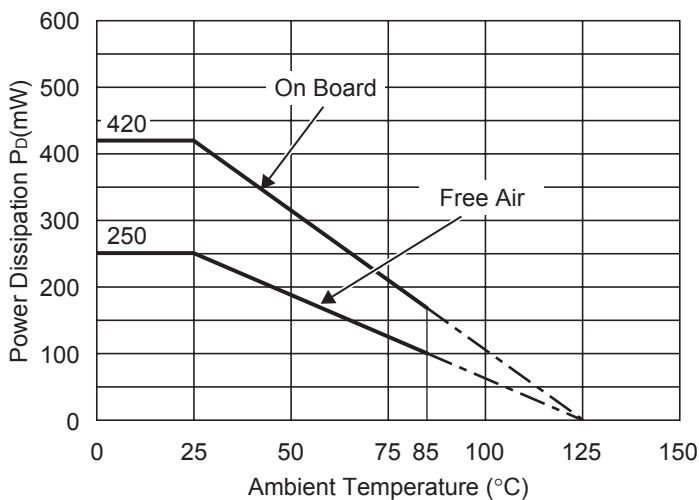

Power Dissipation

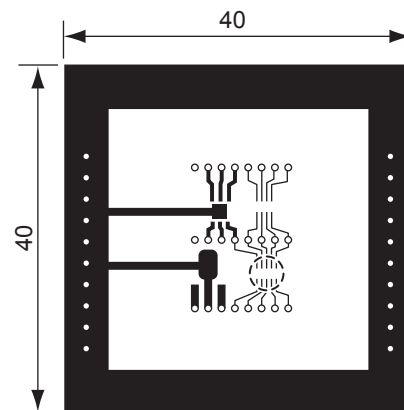

Measurement Board Pattern

○ IC Mount Area Unit : mm

## RECOMMENDED LAND PATTERN

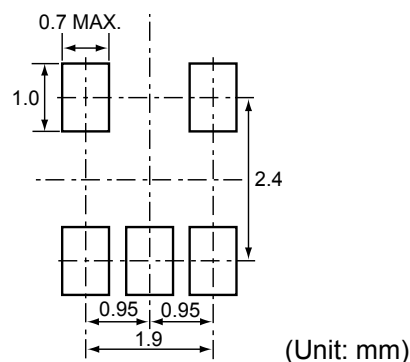

• SON-6

Unit: mm

PACKAGE DIMENSIONS

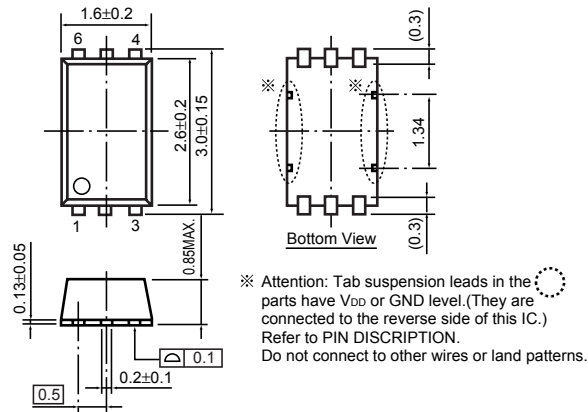

TAPING SPECIFICATION

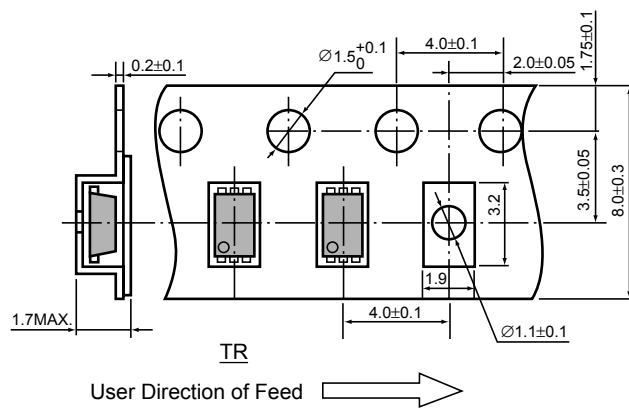

TAPING REEL DIMENSIONS

(1reel=3000pcs)



### POWER DISSIPATION (SON-6)

This specification is at mounted on board. Power Dissipation ( $P_D$ ) depends on conditions of mounting on board. This specification is based on the measurement at the condition below:

Measurement Conditions

	Standard Land Pattern
Environment	Mounting on Board (Wind velocity=0m/s)
Board Material	Glass cloth epoxy plactic (Double sided)
Board Dimensions	40mm × 40mm × 1.6mm
Copper Ratio	Top side : Approx. 50% , Back side : Approx. 50%
Through-hole	φ0.5mm × 44pcs

Measurement Result

( $T_{opt}=25^{\circ}C, T_{jmax}=125^{\circ}C$ )

	Standard Land Pattern	Free Air
Power Dissipation	500mW	250mW
Thermal Resistance	$\theta_{ja}=(125-25^{\circ}C)/0.5W=200^{\circ}C/W$	-

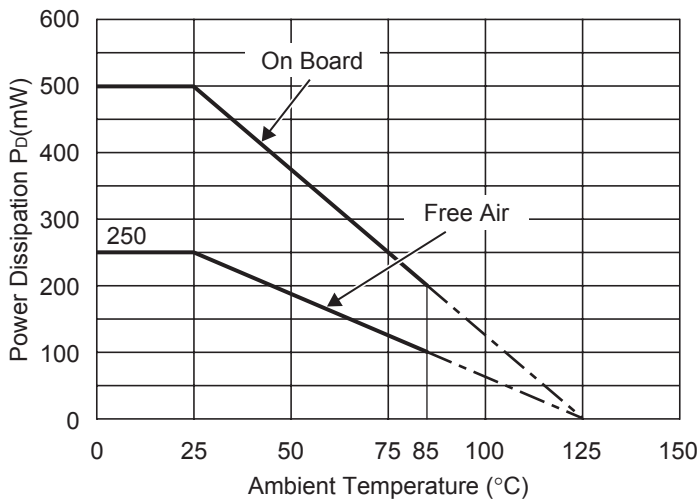

Power Dissipation

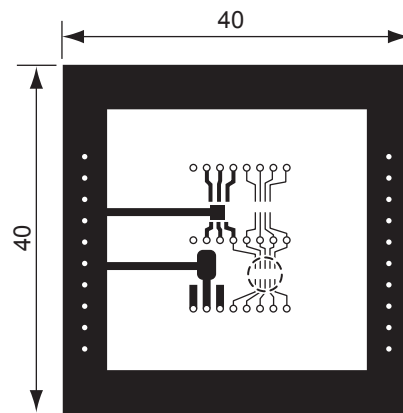

Measurement Board Pattern

○ IC Mount Area (Unit : mm)

### RECOMMENDED LAND PATTERN

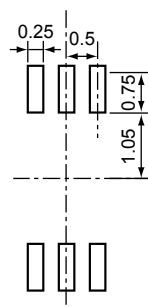

(Unit: mm)

• PLP1616-6

Unit: mm

**PACKAGE DIMENSIONS**

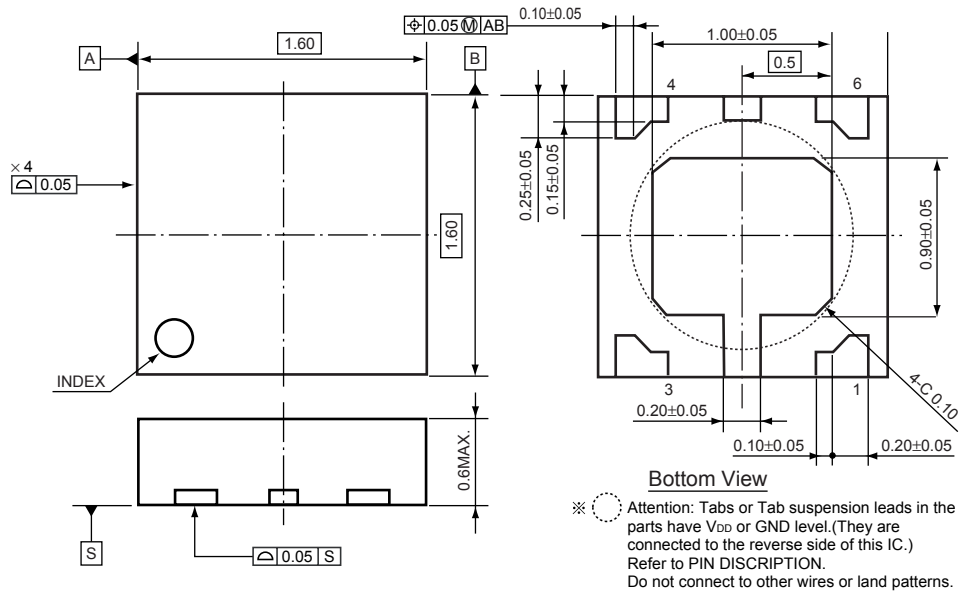

**TAPING SPECIFICATION**

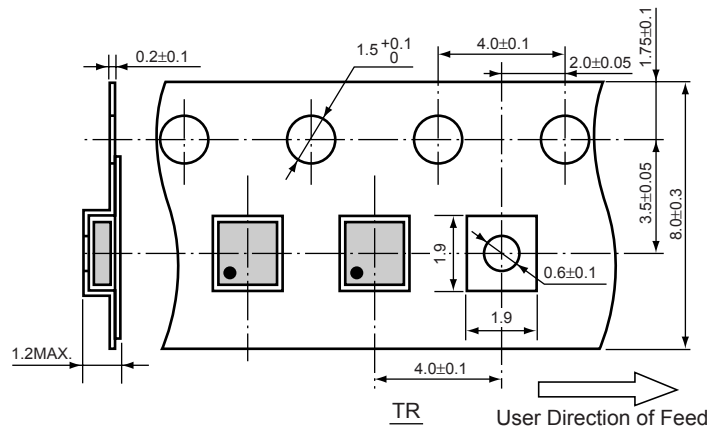

**TAPING REEL DIMENSIONS**

(1reel=5000pcs)

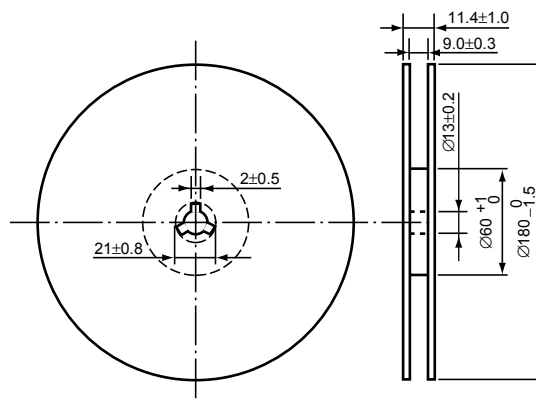



## POWER DISSIPATION (PLP1616-6)

This specification is at mounted on board. Power Dissipation ( $P_D$ ) depends on conditions of mounting on board.

This specification is based on the measurement at the condition below:

(PLP1616-6 is a reference value calculated from the PLP1820-6 package.)

### Measurement Conditions

	Standard Land Pattern
Environment	Mounting on Board (Wind velocity=0m/s)
Board Material	Glass cloth epoxy plastic (Double sided)
Board Dimensions	40mm × 40mm × 1.6mm
Copper Ratio	Top side : Approx. 50% , Back side : Approx. 50%
Through-hole	φ0.54mm × 30pcs

### Measurement Result

( $T_{opt}=25^{\circ}\text{C}$ ,  $T_{jmax}=125^{\circ}\text{C}$ )

	Standard Land Pattern
Power Dissipation	560mW
Thermal Resistance	$\theta_{ja}=(125-25^{\circ}\text{C})/0.56\text{W}=179^{\circ}\text{C/W}$



Power Dissipation



Measurement Board Pattern

○ IC Mount Area Unit : mm

## RECOMMENDED LAND PATTERN



## R1163N SERIES MARK SPECIFICATION

### • SOT-23-5 (SC-74A)



①, ②, ③ : Product Code (refer to Part Number vs. Product Code)

④, ⑤ : Lot Number

### • Part Number vs. Product Code

Part Number	Product Code		
	①	②	③
R1163N151B	V	1	5
R1163N161B	V	1	6
R1163N171B	V	1	7
R1163N181B	V	1	8
R1163N191B	V	1	9
R1163N201B	V	2	0
R1163N211B	V	2	1
R1163N221B	V	2	2
R1163N231B	V	2	3
R1163N241B	V	2	4
R1163N251B	V	2	5
R1163N261B	V	2	6
R1163N271B	V	2	7
R1163N281B	V	2	8
R1163N291B	V	2	9
R1163N301B	V	3	0
R1163N311B	V	3	1
R1163N321B	V	3	2
R1163N331B	V	3	3
R1163N341B	V	3	4
R1163N351B	V	3	5
R1163N361B	V	3	6
R1163N371B	V	3	7
R1163N381B	V	3	8
R1163N391B	V	3	9
R1163N401B	V	4	0
R1163N181B5	V	4	1
R1163N281B5	V	4	2

Part Number	Product Code		
	①	②	③
R1163N151D	W	1	5
R1163N161D	W	1	6
R1163N171D	W	1	7
R1163N181D	W	1	8
R1163N191D	W	1	9
R1163N201D	W	2	0
R1163N211D	W	2	1
R1163N221D	W	2	2
R1163N231D	W	2	3
R1163N241D	W	2	4
R1163N251D	W	2	5
R1163N261D	W	2	6
R1163N271D	W	2	7
R1163N281D	W	2	8
R1163N291D	W	2	9
R1163N301D	W	3	0
R1163N311D	W	3	1
R1163N321D	W	3	2
R1163N331D	W	3	3
R1163N341D	W	3	4
R1163N351D	W	3	5
R1163N361D	W	3	6
R1163N371D	W	3	7
R1163N381D	W	3	8
R1163N391D	W	3	9
R1163N401D	W	4	0
R1163N181D5	W	4	1
R1163N281D5	W	4	2

## R1163D SERIES MARK SPECIFICATION

• SON-6



①, ② : Product Code (refer to Part Number vs. Product Code)

③, ④ : Lot Number

• Part Number vs. Product Code

Part Number	Product Code	
	①	②
R1163D151B	S	5
R1163D161B	S	6
R1163D171B	S	7
R1163D181B	S	8
R1163D191B	S	9
R1163D201B	T	0
R1163D211B	T	1
R1163D221B	T	2
R1163D231B	T	3
R1163D241B	T	4
R1163D251B	T	5
R1163D261B	T	6
R1163D271B	T	7
R1163D281B	T	8
R1163D291B	T	9
R1163D301B	U	0
R1163D311B	U	1
R1163D321B	U	2
R1163D331B	U	3
R1163D341B	U	4
R1163D351B	U	5
R1163D361B	U	6
R1163D371B	U	7
R1163D381B	U	8
R1163D391B	U	9
R1163D401B	V	0
R1163D181B5	V	1
R1163D281B5	V	2

Part Number	Product Code	
	①	②
R1163D151D	W	5
R1163D161D	W	6
R1163D171D	W	7
R1163D181D	W	8
R1163D191D	W	9
R1163D201D	X	0
R1163D211D	X	1
R1163D221D	X	2
R1163D231D	X	3
R1163D241D	X	4
R1163D251D	X	5
R1163D261D	X	6
R1163D271D	X	7
R1163D281D	X	8
R1163D291D	X	9
R1163D301D	Y	0
R1163D311D	Y	1
R1163D321D	Y	2
R1163D331D	Y	3
R1163D341D	Y	4
R1163D351D	Y	5
R1163D361D	Y	6
R1163D371D	Y	7
R1163D381D	Y	8
R1163D391D	Y	9
R1163D401D	Z	0
R1163D181D5	Z	1
R1163D281D5	Z	2

**R1163K SERIES MARK SPECIFICATION**

● **PLP1616-6**



①~④ : Product Code (refer to Part Number vs. Product Code)

⑤, ⑥ : Lot Number

● **Part Number vs. Product Code**

Part Number	Product Code			
	①	②	③	④
R1163K151B	M	1	5	B
R1163K161B	M	1	6	B
R1163K171B	M	1	7	B
R1163K181B	M	1	8	B
R1163K191B	M	1	9	B
R1163K201B	M	2	0	B
R1163K211B	M	2	1	B
R1163K221B	M	2	2	B
R1163K231B	M	2	3	B
R1163K241B	M	2	4	B
R1163K251B	M	2	5	B
R1163K261B	M	2	6	B
R1163K271B	M	2	7	B
R1163K281B	M	2	8	B
R1163K291B	M	2	9	B
R1163K301B	M	3	0	B
R1163K311B	M	3	1	B
R1163K321B	M	3	2	B
R1163K331B	M	3	3	B
R1163K341B	M	3	4	B
R1163K351B	M	3	5	B
R1163K361B	M	3	6	B
R1163K371B	M	3	7	B
R1163K381B	M	3	8	B
R1163K391B	M	3	9	B
R1163K401B	M	4	0	B
R1163K181B5	M	1	8	5
R1163K281B5	M	2	8	5

Part Number	Product Code			
	①	②	③	④
R1163K151D	N	1	5	D
R1163K161D	N	1	6	D
R1163K171D	N	1	7	D
R1163K181D	N	1	8	D
R1163K191D	N	1	9	D
R1163K201D	N	2	0	D
R1163K211D	N	2	1	D
R1163K221D	N	2	2	D
R1163K231D	N	2	3	D
R1163K241D	N	2	4	D
R1163K251D	N	2	5	D
R1163K261D	N	2	6	D
R1163K271D	N	2	7	D
R1163K281D	N	2	8	D
R1163K291D	N	2	9	D
R1163K301D	N	3	0	D
R1163K311D	N	3	1	D
R1163K321D	N	3	2	D
R1163K331D	N	3	3	D
R1163K341D	N	3	4	D
R1163K351D	N	3	5	D
R1163K361D	N	3	6	D
R1163K371D	N	3	7	D
R1163K381D	N	3	8	D
R1163K391D	N	3	9	D
R1163K401D	N	4	0	D
R1163K181D5	N	1	8	5
R1163K281D5	N	2	8	5

Part Number	Product Code			
	①	②	③	④
R1163K151E	P	1	5	E
R1163K161E	P	1	6	E
R1163K171E	P	1	7	E
R1163K181E	P	1	8	E
R1163K191E	P	1	9	E
R1163K201E	P	2	0	E
R1163K211E	P	2	1	E
R1163K221E	P	2	2	E
R1163K231E	P	2	3	E
R1163K241E	P	2	4	E
R1163K251E	P	2	5	E
R1163K261E	P	2	6	E
R1163K271E	P	2	7	E
R1163K281E	P	2	8	E
R1163K291E	P	2	9	E
R1163K301E	P	3	0	E
R1163K311E	P	3	1	E
R1163K321E	P	3	2	E
R1163K331E	P	3	3	E
R1163K341E	P	3	4	E
R1163K351E	P	3	5	E
R1163K361E	P	3	6	E
R1163K371E	P	3	7	E
R1163K381E	P	3	8	E
R1163K391E	P	3	9	E
R1163K401E	P	4	0	E
R1163K181E5	P	1	8	5
R1163K281E5	P	2	8	5

Компания «Океан Электроники» предлагает заключение долгосрочных отношений при поставках импортных электронных компонентов на взаимовыгодных условиях!

Наши преимущества:

- Поставка оригинальных импортных электронных компонентов напрямую с производств Америки, Европы и Азии, а так же с крупнейших складов мира;
- Широкая линейка поставок активных и пассивных импортных электронных компонентов (более 30 млн. наименований);
- Поставка сложных, дефицитных, либо снятых с производства позиций;
- Оперативные сроки поставки под заказ (от 5 рабочих дней);
- Экспресс доставка в любую точку России;
- Помощь Конструкторского Отдела и консультации квалифицированных инженеров;
- Техническая поддержка проекта, помощь в подборе аналогов, поставка прототипов;
- Поставка электронных компонентов под контролем ВП;
- Система менеджмента качества сертифицирована по Международному стандарту ISO 9001;
- При необходимости вся продукция военного и аэрокосмического назначения проходит испытания и сертификацию в лаборатории (по согласованию с заказчиком);
- Поставка специализированных компонентов военного и аэрокосмического уровня качества (Xilinx, Altera, Analog Devices, Intersil, Interpoint, Microsemi, Actel, Aeroflex, Peregrine, VPT, Syfer, Eurofarad, Texas Instruments, MS Kennedy, Miteq, Cobham, E2V, MA-COM, Hittite, Mini-Circuits, General Dynamics и др.);

Компания «Океан Электроники» является официальным дистрибьютором и эксклюзивным представителем в России одного из крупнейших производителей разъемов военного и аэрокосмического назначения «JONHON», а так же официальным дистрибьютором и эксклюзивным представителем в России производителя высокотехнологичных и надежных решений для передачи СВЧ сигналов «FORSTAR».



## JONHON

«JONHON» (основан в 1970 г.)

Разъемы специального, военного и аэрокосмического назначения:

(Применяются в военной, авиационной, аэрокосмической, морской, железнодорожной, горно- и нефтедобывающей отраслях промышленности)

«FORSTAR» (основан в 1998 г.)

ВЧ соединители, коаксиальные кабели,  
кабельные сборки и микроволновые компоненты:

(Применяются в телекоммуникациях гражданского и специального назначения, в средствах связи, РЛС, а так же военной, авиационной и аэрокосмической отраслях промышленности).



Телефон: 8 (812) 309-75-97 (многоканальный)

Факс: 8 (812) 320-03-32

Электронная почта: [ocean@oceanchips.ru](mailto:ocean@oceanchips.ru)

Web: <http://oceanchips.ru/>

Адрес: 198099, г. Санкт-Петербург, ул. Калинина, д. 2, корп. 4, лит. А