

NCV7420

LIN Transceiver with 3.3 V or 5 V Voltage Regulator

General Description

The NCV7420 is a fully featured local interconnect network (LIN) transceiver designed to interface between a LIN protocol controller and the physical bus. The transceiver is implemented in I3T technology enabling both high-voltage analog circuitry and digital functionality to co-exist on the same chip.

The NCV7420 LIN device is a member of the in-vehicle networking (IVN) transceiver family of ON Semiconductor that integrates a LIN v2.0/2.1 physical transceiver and either a 3.3 V or a 5 V voltage regulator. It is designed to work in harsh automotive environment and is submitted to the TS16949 qualification flow.

The LIN bus is designed to communicate low rate data from control devices such as door locks, mirrors, car seats, and sunroofs at the lowest possible cost. The bus is designed to eliminate as much wiring as possible and is implemented using a single wire in each node. Each node has a slave MCU-state machine that recognizes and translates the instructions specific to that function. The main attraction of the LIN bus is that all the functions are not time critical and usually relate to passenger comfort.

KEY FEATURES

LIN-Bus Transceiver

- LIN compliant to specification revision 2.0 and 2.1 (backward compatible to version 1.3) and J2602
- I3T high voltage technology
- Bus voltage ± 45 V
- Transmission rate up to 20 kBaud
- SOIC 14 Green package
- This is a Pb-Free Device

Protection

- Thermal shutdown
- Indefinite short-circuit protection on pins LIN and WAKE towards supply and ground
- Load dump protection (45 V)
- Bus pins protected against transients in an automotive environment
- System ESD protection level for LIN, WAKE and Vbb up to ± 12 kV

EMI Compatibility

- Integrated slope control
- Meets most demanding EMS/EME requirements

Voltage Regulator

- Output voltage 5 V / ~ 50 mA or 3.3 V / ~ 50 mA
- Wake-up input
- Enable inputs for stand-by and sleep mode
- INH output for auxiliary purposes (switching of an external pull-up or resistive divider towards battery, control of an external voltage regulator etc.)

Modes

- Normal mode: LIN communication in either low (up to 10 kBaud) or normal slope
- Sleep mode: V_{CC} is switched “off” and no communication on LIN bus
- Stand-by mode: V_{CC} is switched “on” but there is no communication on LIN bus
- Wake-up bringing the component from sleep mode into standby mode is possible either by LIN command or digital input signal on WAKE pin. Wake-up from LIN bus can also be detected and flagged when the chip is already in standby mode.

Quality

- Automotive Qualification According to AEC-Q100, Grade 1



ON Semiconductor®

<http://onsemi.com>

PIN CONFIGURATION

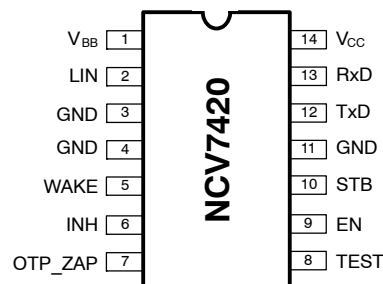

SOIC 14
D SUFFIX
CASE 751AP

ORDERING INFORMATION

See detailed ordering and shipping information in the package dimensions section on page 19 of this data sheet.

NCV7420

Table 1. KEY TECHNICAL CHARACTERISTICS – 3.3 V version

Symbol	Parameter	Min	Typ	Max	Unit
Vbb	Nominal battery operating voltage (Note 1)	5	12	26	V
	Load dump protection (Note 2)			45	
Ibb_SLP	Supply current in sleep mode			20	μA
Vcc_out (Note 4)	Regulated Vcc output, Vcc load 1 mA–30 mA	3.23	3.30	3.37	V
	Regulated Vcc output, Vcc load 0 mA–50 mA	3.19	3.30	3.41	
Iout_max	Maximum Vcc output current (Note 3)	50			mA
V_wake	Operating DC voltage on WAKE pin	0		Vbb	V
	Maximum rating voltage on WAKE pin	–45		45	
Tj	Junction thermal shutdown temperature	165		195	°C
Tjunc	Operating junction temperature	–40		+150	°C

Table 2. KEY TECHNICAL CHARACTERISTICS – 5 V version

Symbol	Parameter	Min	Typ	Max	Unit
Vbb	Nominal battery operating voltage (Note 1)	6	12	26	V
	Load dump protection			45	
Ibb_SLP	Supply current in sleep mode			20	μA
Vcc_out (Note 4)	Regulated Vcc output, Vcc load 1 mA–30 mA	4.9	5.0	5.1	V
	Regulated Vcc output, Vcc load 0 mA–50 mA	4.83	5.0	5.17	
Iout_max	Maximum Vcc output current (Note 3)	50			mA
V_wake	Operating DC voltage on WAKE pin	0		Vbb	V
	Maximum rating voltage on WAKE pin	–45		45	
Tj	Junction thermal shutdown temperature	165		195	°C
Tjunc	Operating junction temperature	–40		+150	°C

1. Below 5 V on VBB in normal mode, the bus will either stay recessive or comply with the voltage level specifications and transition time specifications as required by SAE J2602. It is ensured by the battery monitoring circuit.
2. The applied transients shall be in accordance with ISO 7637 part 1, test pulse 5. The device complies with functional class C; class A can be reached depending on the application and external conditions.
3. Thermal aspects of the entire end-application have to be taken into account in order to avoid thermal shutdown of NCV7420.
4. Vcc voltage regulator output must be properly decoupled by external capacitor of min. 8 μF with ESR < 1 Ω to ensure stability.

Table 3. THERMAL CHARACTERISTICS

Symbol	Parameter	Conditions	Value	Unit
R _{th(vj-a)_1}	Thermal resistance junction-to-ambient on JEDEC 1S0P PCB	free air	140	K/W
R _{th(vj-a)_4}	Thermal resistance junction-to-ambient on JEDEC 2S2P PCB	free air	80	K/W

NCV7420

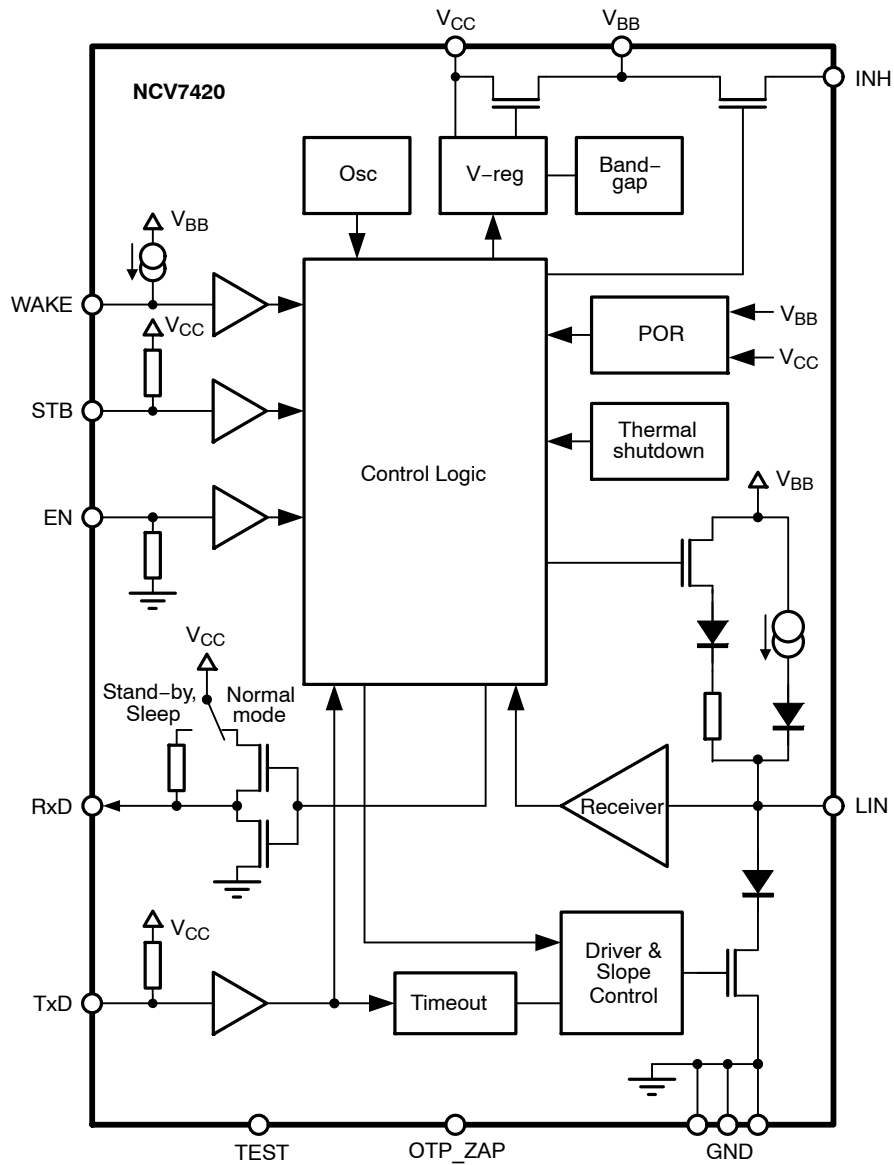

Figure 1. Block Diagram

Typical Application

Application Schematic

The EMC immunity of the Master-mode device can be further enhanced by adding a capacitor between the LIN output and ground. The optimum value of this capacitor is

determined by the length and capacitance of the LIN bus, the number and capacitance of Slave devices, the pull-up resistance of all devices (Master & Slave), and the required time constant of the system, respectively.

V_{CC} voltage must be properly stabilized by external capacitor: capacitor of min. 8 μF (ESR < 1 Ω).

NCV7420

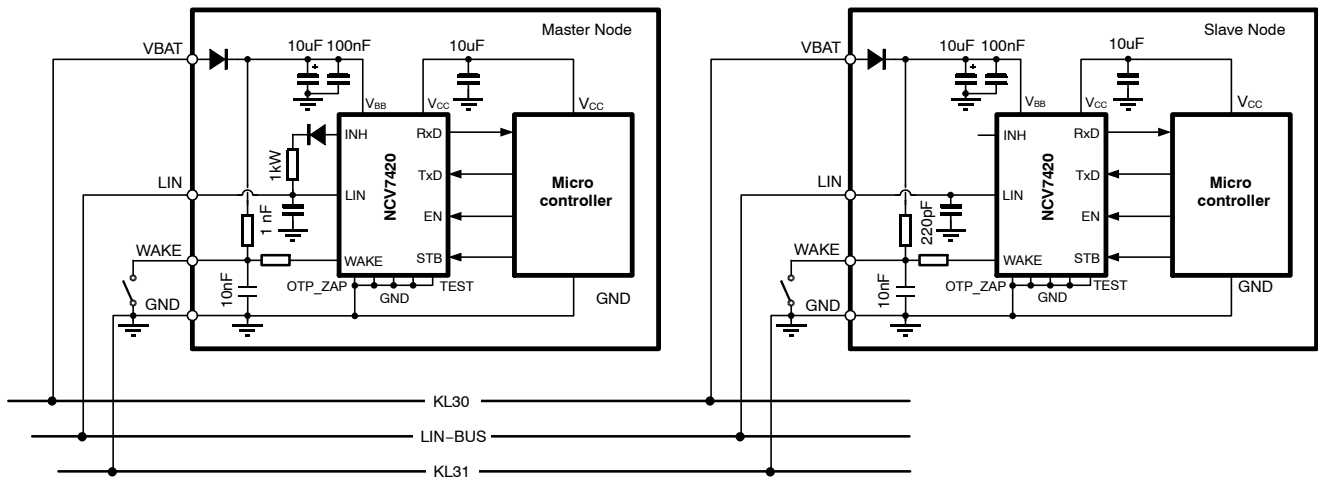

Figure 2. Typical Application Diagram

Table 4. PIN DESCRIPTION

Pin	Name	Description
1	VBB	Battery supply input
2	LIN	LIN bus output/input
3	GND	Ground
4	GND	Ground
5	WAKE	High voltage digital input pin to switch the part from sleep- to standby mode
6	INH	Inhibit output
7	OTP_ZAP	Supply for programming of trimming bits at factory testing, should be grounded in the application
8	TEST	Digital input for factory testing, should be grounded in the application
9	EN	Enable input, transceiver in normal operation mode when high
10	STB	Standby mode control input
11	GND	Ground
12	TxD	Transmit data input, low in dominant state
13	RxD	Receive data output; low in dominant state; push-pull output
14	Vcc	Supply voltage (output)

Overall Functional Description

LIN is a serial communication protocol that efficiently supports the control of mechatronic nodes in distributed automotive applications. The domain is class-A multiplex buses with a single master node and a set of slave nodes.

NCV7420 is designed as a master or slave node for the LIN communication interface with an integrated 3.3 V or 5 V voltage regulator having a current capability up to 50 mA for supplying any external components (microcontroller).

NCV7420 contains the LIN transmitter, LIN receiver, voltage regulator, power-on-reset (POR) circuits and thermal shutdown (TSD). The LIN transmitter is optimized for the maximum specified transmission speed of 20 kBaud

with EMC performance due to reduced slew rate of the LIN output.

The junction temperature is monitored via a thermal shutdown circuit that switches the LIN transmitter and voltage regulator off when temperature exceeds the TSD trigger level.

NCV7420 has four operating states (normal mode, low slope mode, stand-by mode, and sleep mode) that are determined by the input signals EN, WAKE, STB, and TxD.

Operating States

NCV7420 provides four operating states, two modes for normal operation with communication, one stand-by without communication and one low power mode with very low current consumption. See Figure 3.

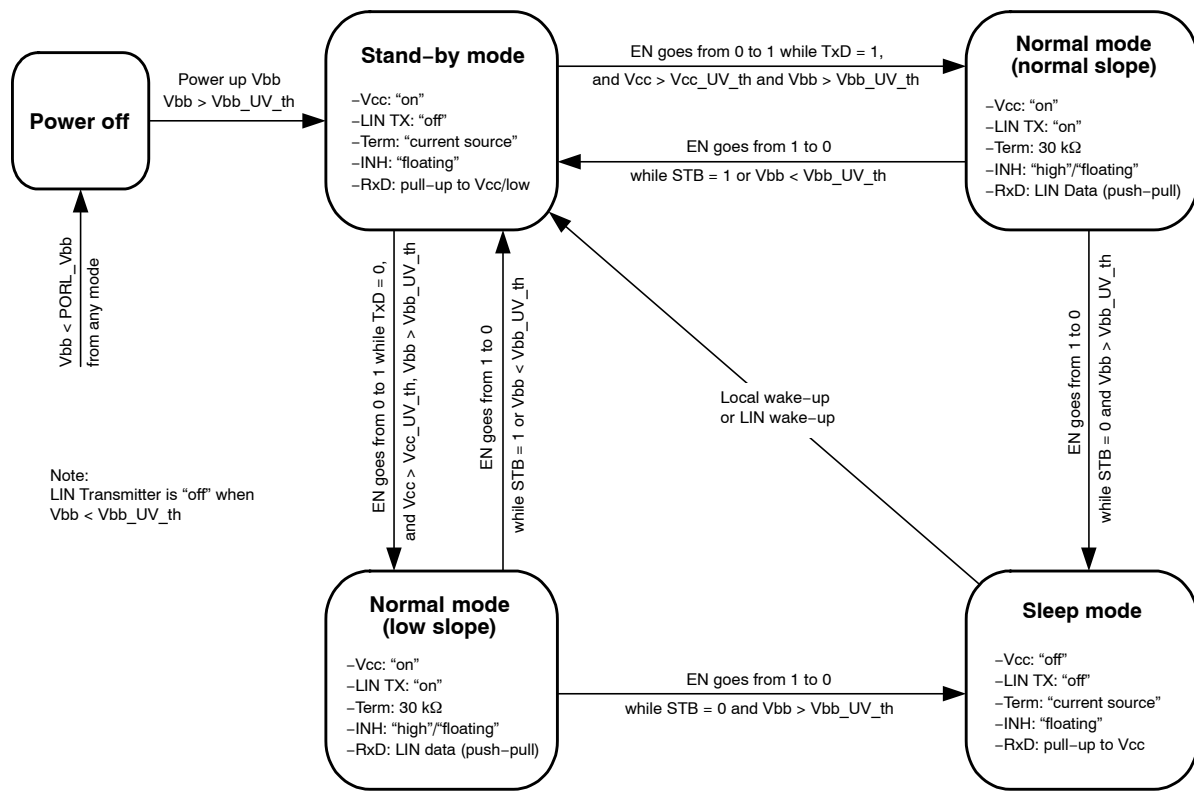

Figure 3. State Diagram

Table 5. MODE SELECTION

Mode	Vcc	RxD	INH	LIN	30 kΩ on LIN	Note
Normal – Slope	ON	Low = Dominant State High = Recessive State	High if STB=High during state transition; Floating otherwise	Normal Slope	ON	(Note 5)
Normal – Low Slope	ON	Low = Dominant State High = Recessive State	High if STB=High during state transition; Floating otherwise	Low Slope	ON	(Note 6)
Stand-by	ON	Low after LIN wakeup, high otherwise	Floating	OFF	OFF	(Notes 7 and 8)
Sleep	OFF	Clamped to Vcc	Floating	OFF	OFF	

- The normal slope mode is entered when pin EN goes HIGH while TxD is in HIGH state during EN transition.
- The low slope mode is entered when pin EN goes HIGH while TxD is in LOW state during EN transition. LIN transmitter gets on only after TxD returns to high after the state transition.
- The stand-by mode is entered automatically after power-up.
- In Stand-by mode, RxD High state is achieved by internal pull-up resistor to VCC.

Normal Slope Mode

In normal slope mode the transceiver can transmit and receive data via LIN bus with speed up to 20 kbaud. The transmit data stream of the LIN protocol is present on the TxD pin and converted by the transmitter into a LIN bus signal with controlled slew rate to minimize EMC emission. The receiver consists of the comparator that has a threshold with hysteresis in respect to the supply voltage and an input filter to remove bus noise. The LIN output is pulled HIGH via an internal 30 kΩ pull-up resistor. For master applications it is needed to put an external 1 kΩ resistor with a serial diode between LIN and Vbb (or INH). See Figure 2. The mode selection is done by EN=HIGH when TxD pin is

HIGH. If STB pin is high during the standby-to-normal slope mode transition, INH pin is pulled high. Otherwise, it stays floating.

Low Slope Mode

In low slope mode the slew rate of the signal on the LIN bus is reduced (rising and falling edges of the LIN bus signal are longer). This further reduces the EMC emission. As a consequence the maximum speed on the LIN bus is reduced up to 10 kbaud. This mode is suited for applications where the communication speed is not critical. The mode selection is done by EN=HIGH when TxD pin is LOW. In order not to transmit immediately a dominant state on the bus (because

TxD=LOW), the LIN transmitter is enabled only after TxD returns to HIGH. If STB pin is high during the standby-to-low slope mode transition, INH pin is pulled high. Otherwise, it stays floating.

Stand-by Mode

The stand-by mode is always entered after power-up of the NCV7420. It can also be entered from normal mode when the EN pin is low and the stand-by pin is high. From sleep mode it can be entered after a local wake-up or LIN wakeup. In stand-by mode the Vcc voltage regulator for supplying external components (e.g. a microcontroller) stays active. Also the LIN receiver stays active to be able to detect a remote wake-up via bus. The LIN transmitter is disabled and the slave internal termination resistor of 30 kΩ between LIN and Vbb is disconnected in order to minimize current consumption. Only a pull-up current source between Vbb and LIN is active.

Sleep Mode

The Sleep Mode provides extreme low current consumption. This mode is entered when both EN and STB pins are LOW coming from normal mode. The internal termination resistor of 30 kΩ between LIN and Vbb is disconnected and also the Vcc regulator is switched off to minimize current consumption.

Wake-up

NCV7420 has two possibilities to wake-up from sleep or stand-by mode (see Figure 3):

- Local wake-up: enables the transition from sleep mode to stand-by mode
- Remote wake-up via LIN: enables the transition from sleep- to stand-by mode and can be also detected when already in standby mode.

A local wake-up is **only** detected in sleep mode if a transition from LOW to HIGH or from HIGH to LOW is seen on the wake pin.

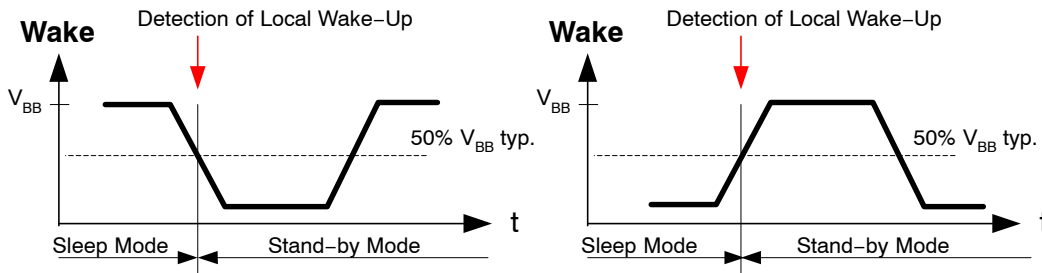

Figure 4. Local Wake-up Signal

A remote wake-up is **only** detected if a combination of (1) a falling edge at the LIN pin (transition from recessive to dominant) is followed by (2) a dominant level maintained

for a time period > t_{WAKE} and (3) again a rising edge at pin LIN (transition from dominant to recessive) happens.

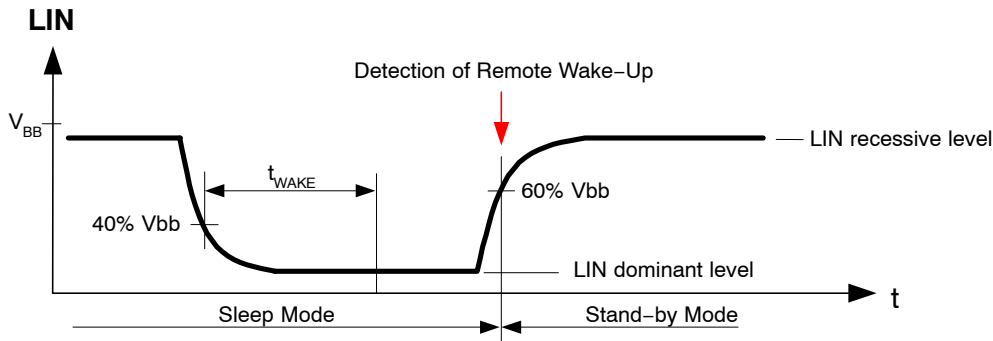

Figure 5. Remote Wake-up Behavior

The wake-up source is distinguished by pin RxD in the stand-by mode:

- RxD remains HIGH after power-up or local wake-up.
- RxD is kept LOW until normal mode is entered after a remote wake-up (LIN).

NCV7420

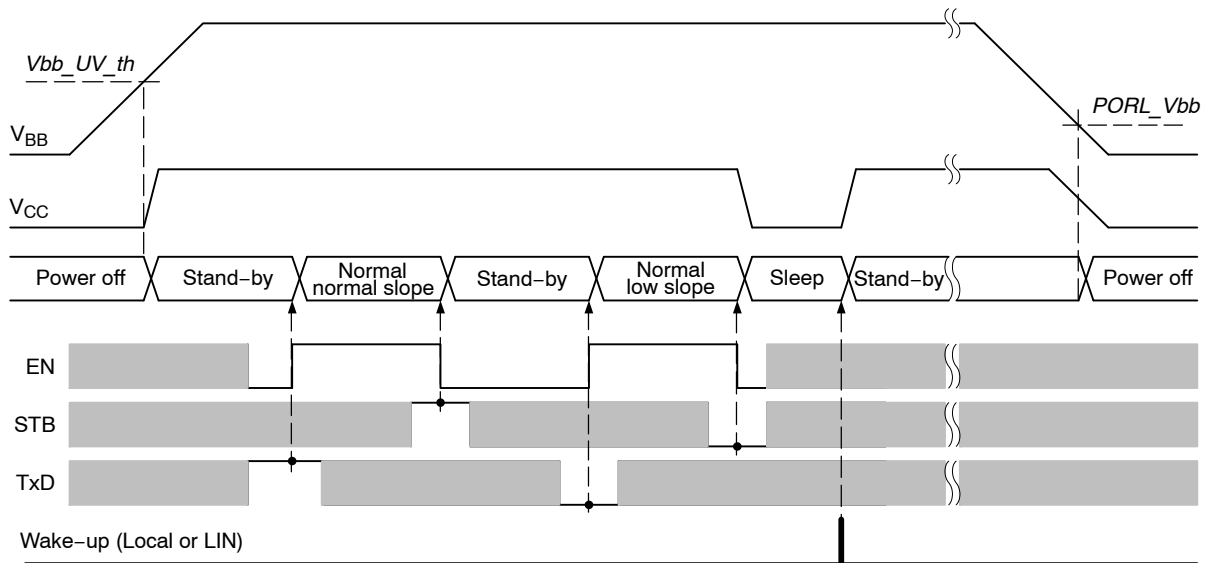

Figure 6. Operating Modes Transitions

NCV7420

Electrical Characteristics

Definitions

All voltages are referenced to GND (Pin 11). Positive currents flow into the IC.

Table 6. ABSOLUTE MAXIMUM RATINGS – 3.3 V and 5 V versions

Symbol	Parameter	Min	Max	Unit
Vbb	Battery voltage on pin Vbb (Note 9)	-0.3	+45	V
Vcc	DC voltage on pin Vcc	0	+7	V
I_Vcc	Current delivered by the Vcc regulator	50		mA
V_LIN	LIN bus voltage (Note 10)	-45	+45	V
V_INH	DC voltage on inhibit pin	-0.3	Vbb + 0.3	V
V_WAKE	DC voltage on WAKE pin	-45	45	V
V_Dig_in	DC input voltage on pins TxD, RxD, EN, STB	-0.3	Vcc + 0.3	V
Tjunc	Maximum junction temperature	-40	+165	°C
Vesd	Electrostatic discharge voltage on all pins; HBM (Note 11)	-2	+2	kV
	Electrostatic discharge voltage on LIN, INH, WAKE and Vbb towards GND; HBM (Note 11)	-4	+4	kV
	Electrostatic discharge on LIN, WAKE and Vbb; system HBM (Note 12)	-8	+8	kV
	Electrostatic discharge voltage on all pins; CDM (Note 14)	-500	+500	V
Vesd (EMC/ESD improved versions)	Electrostatic discharge voltage on all pins; HBM (Note 11)	-4	+4	kV
	Electrostatic discharge voltage on LIN, INH, WAKE and Vbb towards GND; HBM (Note 11)	-6	+6	kV
	Electrostatic discharge on LIN, WAKE and Vbb; system HBM (Note 13)	-12	+12	kV
	Electrostatic discharge voltage on all pins; CDM (Note 14)	-750	+750	V

Stresses exceeding Maximum Ratings may damage the device. Maximum Ratings are stress ratings only. Functional operation above the Recommended Operating Conditions is not implied. Extended exposure to stresses above the Recommended Operating Conditions may affect device reliability.

9. The applied transients shall be in accordance with ISO 7637 part 1, test pulses 1, 2, 3a, 3b, and 5. The device complies with functional class C; class A can be reached depending on the application and external components.
10. The applied transients shall be in accordance with ISO 7637 part 1, test pulses 1, 2, 3a, and 3b. The device complies with functional class C; class A can be reached depending on the application and external components.
11. Equivalent to discharging a 100 pF capacitor through a 1500 Ω resistor.
12. Equivalent to discharging a 150 pF capacitor through a 330 Ω resistor conform to IEC Standard 61000-4-2. LIN bus filter 220 pF, Vbb blocking capacitor 100 nF, 3k3/10n R/C network on WAKE.
13. Equivalent to discharging a 150 pF capacitor through a 330 Ω resistor conform to IEC Standard 61000-4-2. No filter on LIN, Vbb blocking capacitor 100 nF, 3k3/10n R/C network on WAKE.
14. Charged device model according ESD-STM5.3.1.

NCV7420

DC Characteristics – 3.3 V version ($V_{BB} = 5\text{ V to }26\text{ V}$; $T_{junc} = -40^{\circ}\text{C to }+150^{\circ}\text{C}$; unless otherwise specified.)

Table 7. DC CHARACTERISTICS, SUPPLY – Pin VBB

Symbol	Parameter	Conditions	Min	Typ	Max	Unit
I _{bb_ON}	Supply current	Normal mode; LIN recessive			1.6	mA
I _{bb_STB}	Supply current	Stand-by mode, V _{bb} = 5–18 V, T _{junc} < 105°C			70	μA
I _{bb_SLP}	Supply current	Sleep mode, V _{bb} = 5–18 V, T _{junc} < 105°C			20	μA

Table 8. DC CHARACTERISTICS, VOLTAGE REGULATOR – Pin VCC

V _{cc_out}	Regulator output voltage	V _{cc} load 1 mA – 30 mA	3.23	3.30	3.37	V
		V _{cc} load 0 mA – 50 mA	3.19	3.30	3.41	
I _{out_max_abs}	Absolute maximum output current	Thermal shutdown must be taken into account			50	mA
I _{out_lim}	Over-current limitation		50	100	170	mA
ΔV _{cc_out}	Line Regulation (Note 20)	V _{bb} 5–26 V, I _{out} = 5 mA, T _j = 25°C		0.5		mV
	Load Regulation (Note 20)	I _{out} 1–50 mA, V _{bb} = 14 V, T _j = 25°C		45		mV
V _{do}	Dropout Voltage (V _{bb} –V _{cc_out}) Figure 11, (Notes 19, 20)	I _{out} = 1 mA, T _j = 25°C		13		mV
		I _{out} = 10 mA, T _j = 25°C		134		mV
		I _{out} = 50 mA, T _j = 25°C		732		mV

Table 9. DC CHARACTERISTICS LIN TRANSMITTER – Pin LIN

Symbol	Parameter	Conditions	Min	Typ	Max	Unit
V _{Lin_dom_LoSup}	LIN dominant output voltage	TXD = low; V _{bb} = 7.3 V			1.2	V
V _{Lin_dom_HiSup}	LIN dominant output voltage	TXD = low; V _{bb} = 18 V			2.0	V
V _{ser_diode}	LIN Voltage drop at serial diode (Note 15)	TXD = high; I _{lin} = 10 μA	0.3		1	V
I _{LIN_lim}	Short circuit current limitation	V _{Lin} = V _{bb_max}	40		200	mA
R _{slave}	Internal pull-up resistance		20	33	47	kΩ
CLIN	Capacitance on pin LIN (Note 17)			15	25	pF
I _{LIN_off_dom}	LIN output current bus in dominant state	Driver off; V _{bb} = 12 V	–1			mA
I _{LIN_off_rec}	LIN output current bus in recessive state	Driver off; V _{bb} < 18 V V _{bb} < V _{Lin} < 18 V			1	μA
I _{LIN_no_GND}	Communication not affected	V _{bb} = GND = 12 V; 0 < V _{Lin} < 18 V	–1		1	mA
I _{LIN_no_Vbb}	LIN bus remains operational	V _{bb} = GND = 0 V; 0 < V _{Lin} < 18 V			5	μA

Table 10. DC CHARACTERISTICS LIN RECEIVER – Pin LIN

Symbol	Parameter	Conditions	Min	Typ	Max	Unit
V _{bus_dom}	Bus voltage for dominant state				0.4	V _{bb}
V _{bus_rec}	Bus voltage for recessive state		0.6			V _{bb}
V _{rec_dom}	Receiver threshold	LIN bus recessive → dominant	0.4		0.6	V _{bb}
V _{rec_rec}	Receiver threshold	LIN bus dominant → recessive	0.4		0.6	V _{bb}

15. The voltage drop in Normal mode between LIN and VBB pin is the sum of the diode drop and the drop at serial pull up resistor. The drop at the switch is negligible. See Figure 1.

16. By one of the trimming bits, following reconfiguration can be done during chip-level testing in order to fit the NCV7420_3 into different interface: pins TxD and EN will have typ. 10 kΩ pull-down resistor to ground and pin WAKE will have typ. 10 μA pull-up current source.

17. Guaranteed by design. Not tested.

18. V_{bb} under-voltage threshold is always higher than V_{bb} POR low level (V_{bb_UV_th} > PORL_VBB)

19. Measured at output voltage V_{cc_out} = (V_{cc_out@Vbb} = 5 V) – 2%.

20. Values based on design and characterization. Not tested in production.

NCV7420

DC Characteristics – 3.3 V version ($V_{BB} = 5\text{ V to }26\text{ V}$; $T_{junc} = -40^{\circ}\text{C to }+150^{\circ}\text{C}$; unless otherwise specified.)

Table 10. DC CHARACTERISTICS LIN RECEIVER – Pin LIN

Symbol	Parameter	Conditions	Min	Typ	Max	Unit
Vrec_cnt	Receiver centre voltage	$(V_{bus_dom} + V_{bus_rec}) / 2$	0.475		0.525	V _{bb}
Vrec_hys	Receiver hysteresis		0.05		0.175	V _{bb}

Table 11. DC CHARACTERISTICS I/Os

Symbol	Parameter	Conditions	Min	Typ	Max	Unit
Pin WAKE						
V_wake_th	Threshold voltage		0.35		0.65	V _{bb}
I_leak	Input leakage current (Note 16)	$V_{wake} = 0\text{ V}$; $V_{bb} = 18\text{ V}$	-1	-0.5	1	μA
T_wake_min	Debounce time	Sleep mode; rising and falling edge	8		54	μs

Pins TxD and STB

Vil	Low level input voltage				0.8	V
Vih	High level input voltage		2.0			V
Rpu	Pull-up resistance to V _{cc} (Note 16)		50		200	kΩ

Pin INH

Delta_VH	High level voltage drop	IINH = 15 mA		0.35	0.75	V
I_leak	Leakage current	Sleep mode; VINH = 0 V	-1		1	μA

Pin EN

Vil	Low level input voltage				0.8	V
Vih	High level input voltage		2.0			V
Rpd	Pull-down resistance to ground (Note 16)		50		200	kΩ

Pin RxD

Vol	Low level output voltage	I _{sink} = 2 mA			0.65	V
Voh	High level output voltage (In Normal mode)	Normal mode, I _{source} = -2 mA	V _{cc} - 0.65 V			V
Rpu	Pull-up resistance to V _{cc} (In Standby and Sleep mode)	Standby mode, Sleep mode	5	10	15	kΩ

Table 12. DC CHARACTERISTICS

Symbol	Parameter	Conditions	Min	Typ	Max	Unit
POR						
Vbb_UV_th	V _{bb} under-voltage threshold (Note 18)		3	4.2	4.75	V
PORL_Vbb	V _{bb} POR low level comparator	NCV7420D23	2.5		4.2	V
		NCV7420D24	1.7		3.8	V
VCC_UV_th	V _{CC} under-voltage threshold		2		3	V
TSD						
T _j	Junction temperature	For shutdown	165		195	°C
T _{j_hyst}	Thermal shutdown hysteresis		9		18	°C

15. The voltage drop in Normal mode between LIN and V_{BB} pin is the sum of the diode drop and the drop at serial pull up resistor. The drop at the switch is negligible. See Figure 1.

16. By one of the trimming bits, following reconfiguration can be done during chip-level testing in order to fit the NCV7420_3 into different interface: pins TxD and EN will have typ. 10 kΩ pull-down resistor to ground and pin WAKE will have typ. 10 μA pull-up current source.

17. Guaranteed by design. Not tested.

18. V_{bb} under-voltage threshold is always higher than V_{bb} POR low level ($V_{bb_UV_th} > PORL_VBB$)

19. Measured at output voltage $V_{cc_out} = (V_{cc_out@V_{bb} = 5\text{ V}}) - 2\%$.

20. Values based on design and characterization. Not tested in production.

NCV7420

DC Characteristics – 5 V version – ($V_{BB} = 6\text{ V to }26\text{ V}$; $T_{junc} = -40^{\circ}\text{C to }+150^{\circ}\text{C}$; unless otherwise specified.)

Table 13. DC CHARACTERISTICS, SUPPLY – Pin VBB

Symbol	Parameter	Conditions	Min	Typ	Max	Unit
lbb_ON	Supply current	Normal mode; LIN recessive			1.6	mA
lbb_STB	Supply current	Stand-by mode, $V_{bb} = 6\text{--}18\text{ V}$, $T_{junc} < 105^{\circ}\text{C}$			70	μA
lbb_SLP	Supply current	Sleep mode, $V_{bb} = 6\text{--}18\text{ V}$, $T_{junc} < 105^{\circ}\text{C}$			20	μA

Table 14. DC CHARACTERISTICS, VOLTAGE REGULATOR – Pin VCC

Vcc_out	Regulator output voltage	Vcc load 1 mA – 30 mA	4.9	5.0	5.1	V
		Vcc load 0 mA – 50 mA	4.83	5.0	5.17	
lout_max_abs	Absolute maximum output current	Thermal shutdown must be taken into account			50	mA
lout_lim	Over-current limitation		50	100	170	mA
ΔV_{cc_out}	Line Regulation (Note 26)	$V_{bb} 6\text{--}26\text{ V}$, $l_{out} = 5\text{ mA}$, $T_j = 25^{\circ}\text{C}$		0.9		mV
	Load Regulation (Note 26)	$l_{out} 1\text{--}50\text{ mA}$, $V_{bb} = 14\text{ V}$, $T_j = 25^{\circ}\text{C}$		74		mV
Vdo	Dropout Voltage ($V_{bb}\text{--}V_{cc_out}$) Figure 19 (Notes 25, 26)	$l_{out} = 1\text{ mA}$, $T_j = 25^{\circ}\text{C}$		13		mV
		$l_{out} = 10\text{ mA}$, $T_j = 25^{\circ}\text{C}$		136		mV
		$l_{out} = 50\text{ mA}$, $T_j = 25^{\circ}\text{C}$		794		mV

Table 15. DC CHARACTERISTICS LIN TRANSMITTER – Pin LIN

Symbol	Parameter	Conditions	Min	Typ	Max	Unit
VLin_dom_LoSup	LIN dominant output voltage	TXD = low; $V_{bb} = 7.3\text{ V}$			1.2	V
VLin_dom_HiSup	LIN dominant output voltage	TXD = low; $V_{bb} = 18\text{ V}$			2.0	V
Vser_diode	LIN Voltage drop at serial diode (Note 21)	TXD = high; $I_{lin} = 10\ \mu\text{A}$	0.3		1	V
ILIN_lim	Short circuit current limitation	$V_{Lin} = V_{bb_max}$	40		200	mA
Rslave	Internal pull-up resistance		20	33	47	k Ω
CLIN	Capacitance on pin LIN (Note 23)			15	25	pF
ILIN_off_dom	LIN output current bus in dominant state	Driver off; $V_{bb} = 12\text{ V}$	-1			mA
ILIN_off_rec	LIN output current bus in recessive state	Driver off; $V_{bb} < 18\text{ V}$ $V_{bb} < V_{Lin} < 18\text{ V}$			1	μA
ILIN_no_GND	Communication not affected	$V_{bb} = \text{GND} = 12\text{ V}$; $0 < V_{Lin} < 18\text{ V}$	-1		1	mA
ILIN_no_Vbb	LIN bus remains operational	$V_{bb} = \text{GND} = 0\text{ V}$; $0 < V_{Lin} < 18\text{ V}$			5	μA

Table 16. DC CHARACTERISTICS LIN RECEIVER – Pin LIN

Symbol	Parameter	Conditions	Min	Typ	Max	Unit
Vbus_dom	Bus voltage for dominant state				0.4	Vbb
Vbus_rec	Bus voltage for recessive state		0.6			Vbb
Vrec_dom	Receiver threshold	LIN bus recessive \rightarrow dominant	0.4		0.6	Vbb

21. The voltage drop in Normal mode between LIN and VBB pin is the sum of the diode drop and the drop at serial pull up resistor. The drop at the switch is negligible. See Figure 1.

22. By one of the trimming bits, following reconfiguration can be done during chip-level testing in order to fit the NCV7420_5 into different interface: pins TxD and EN will have typ. 10 k Ω pull-down resistor to ground and pin WAKE will have typ. 10 μA pull-up current source.

23. Guaranteed by design. Not tested.

24. Vbb under-voltage threshold is always higher than Vbb POR low level ($V_{bb_UV_th} > \text{PORL_VBB}$)

25. Measured at output voltage $V_{cc_out} = (V_{cc_out@V_{bb} = 6\text{ V}}) - 2\%$.

26. Values based on design and characterization. Not tested in production.

NCV7420

DC Characteristics – 5 V version – ($V_{BB} = 6\text{ V to }26\text{ V}$; $T_{junc} = -40^{\circ}\text{C to }+150^{\circ}\text{C}$; unless otherwise specified.)

Symbol	Parameter	Conditions	Min	Typ	Max	Unit
--------	-----------	------------	-----	-----	-----	------

Table 16. DC CHARACTERISTICS LIN RECEIVER – Pin LIN

Vrec_rec	Receiver threshold	LIN bus dominant → recessive	0.4		0.6	V _{bb}
Vrec_cnt	Receiver center voltage	$(V_{bus_dom} + V_{bus_rec}) / 2$	0.475		0.525	V _{bb}
Vrec_hys	Receiver hysteresis		0.05		0.175	V _{bb}

Table 17. DC CHARACTERISTICS I/OS

Symbol	Parameter	Conditions	Min	Typ	Max	Unit
--------	-----------	------------	-----	-----	-----	------

Pin WAKE

V_wake_th	Threshold voltage		0.35		0.65	V _{bb}
I_leak	Input leakage current (Note 22)	V _{wake} = 0 V; V _{bb} = 18 V	-1	-0.5	1	μA
T_wake_min	Debounce time	Sleep mode; rising and falling edge	8		54	μs

Pins TxD and STB

V _{il}	Low level input voltage				0.8	V
V _{ih}	High level input voltage		2.0			V
R _{pu}	Pull-up resistance to V _{cc} (Note 22)		50		200	kΩ

Pin INH

Delta_VH	High level voltage drop	I _{INH} = 15 mA		0.35	0.75	V
I_leak	Leakage current	Sleep mode; V _{INH} = 0 V	-1		1	μA

Pin EN

V _{il}	Low level input voltage				0.8	V
V _{ih}	High level input voltage		2.0			V
R _{pd}	Pull-down resistance to ground (Note 22)		50		200	kΩ

Pin RxD

V _{ol}	Low level output voltage	I _{sink} = 2 mA			0.65	V
V _{oh}	High level output voltage (In Normal mode)	Normal mode, I _{source} = -2 mA	V _{cc} - 0.65 V			V
R _{pu}	Pull-up resistance to V _{cc} (In Standby and Sleep mode)	Standby mode, Sleep mode	5	10	15	kΩ

Table 18. DC CHARACTERISTICS

Symbol	Parameter	Conditions	Min	Typ	Max	Unit
--------	-----------	------------	-----	-----	-----	------

POR

V _{bb_UV_th}	V _{bb} under-voltage threshold (Note 24)		3	4.2	4.75	V
PORL_V _{bb}	V _{bb} POR low level comparator	NCV7420D25	2.5		4.2	V
		NCV7420D26	1.7		3.8	V
V _{CC_UV_th}	V _{CC} under-voltage threshold		3		4.5	V

TSD

T _j	Junction temperature	For shutdown	165		195	°C
T _{j_hyst}	Thermal shutdown hysteresis		9		18	°C

21. The voltage drop in Normal mode between LIN and V_{BB} pin is the sum of the diode drop and the drop at serial pull up resistor. The drop at the switch is negligible. See Figure 1.

22. By one of the trimming bits, following reconfiguration can be done during chip-level testing in order to fit the NCV7420_5 into different interface: pins TxD and EN will have typ. 10 kΩ pull-down resistor to ground and pin WAKE will have typ. 10 μA pull-up current source.

23. Guaranteed by design. Not tested.

24. V_{bb} under-voltage threshold is always higher than V_{bb} POR low level (V_{bb_UV_th} > PORL_V_{BB})

25. Measured at output voltage V_{cc_out} = (V_{cc_out@V_{bb} = 6 V}) - 2%.

26. Values based on design and characterization. Not tested in production.

NCV7420

AC Characteristics – 3.3 V and 5 V versions – ($V_{BB} = 7\text{ V to }18\text{ V}$; $T_{junc} = -40^{\circ}\text{C to }+150^{\circ}\text{C}$; unless otherwise specified.)

Table 19. AC CHARACTERISTICS LIN TRANSMITTER – Pin LIN

Symbol	Parameter	Conditions	Min	Typ	Max	Unit
D1	Duty Cycle 1 = $t_{BUS_REC(min)} / (2 \times T_{BIT})$ see Figure 23	Normal slope mode $TH_{REC(max)} = 0.744 \times V_{BB}$ $TH_{DOM(max)} = 0.581 \times V_{BB}$ $T_{BIT} = 50\ \mu\text{s}$ $V(V_{BB}) = 7\text{ V to }18\text{ V}$	0.396		0.5	
D2	Duty Cycle 2 = $t_{BUS_REC(max)} / (2 \times T_{BIT})$ see Figure 23	Normal slope mode $TH_{REC(min)} = 0.422 \times V_{BB}$ $TH_{DOM(min)} = 0.284 \times V_{BB}$ $T_{BIT} = 50\ \mu\text{s}$ $V(V_{BB}) = 7.6\text{ V to }18\text{ V}$	0.5		0.581	
D3	Duty Cycle 3 = $t_{BUS_REC(min)} / (2 \times T_{BIT})$ see Figure 23	Normal slope mode $TH_{REC(max)} = 0.778 \times V_{BB}$ $TH_{DOM(max)} = 0.616 \times V_{BB}$ $T_{BIT} = 96\ \mu\text{s}$ $V(V_{BB}) = 7\text{ V to }18\text{ V}$	0.417		0.5	
D4	Duty Cycle 4 = $t_{BUS_REC(max)} / (2 \times T_{BIT})$ see Figure 23	Normal slope mode $TH_{REC(min)} = 0.389 \times V_{BB}$ $TH_{DOM(min)} = 0.251 \times V_{BB}$ $T_{BIT} = 96\ \mu\text{s}$ $V(V_{BB}) = 7.6\text{ V to }18\text{ V}$	0.5		0.590	
Ttrx_prop_down	Propagation Delay of TxD to LIN. TxD high to low	(Note 27)			6	μs
Ttrx_prop_up	Propagation Delay of TxD to LIN. TxD low to high	(Note 27)			6	μs
T_fall_norm	LIN falling edge	Normal slope mode; $V_{BB} = 12\text{ V}$; L1, L2 (Note 28)			22.5	μs
T_rise_norm	LIN rising edge	Normal slope mode; $V_{BB} = 12\text{ V}$; L1, L2 (Note 28)			22.5	μs
T_sym_norm	LIN slope symmetry	Normal slope mode; $V_{BB} = 12\text{ V}$; L1, L2 (Note 28)	-4		4	μs
T_fall_norm	LIN falling edge	Normal slope mode; $V_{BB} = 12\text{ V}$; L3 (Note 28)			27	μs
T_rise_norm	LIN rising edge	Normal slope mode; $V_{BB} = 12\text{ V}$; L3 (Note 28)			27	μs
T_sym_norm	LIN slope symmetry	Normal slope mode; $V_{BB} = 12\text{ V}$; L3 (Note 28)	-5		5	μs
T_fall_low	LIN falling edge	Low slope mode (Note 29); $V_{BB} = 12\text{ V}$; L3 (Note 28)			62	μs
T_rise_low	LIN rising edge	Low slope mode (Note 29); $V_{BB} = 12\text{ V}$; L3 (Note 28)			62	μs
T_wake	Dominant time-out for wake-up via LIN bus		30		150	μs
T_dom	TxD dominant time-out	TxD = low	6		20	ms

27. Values based on design and characterization. Not tested in production.

28. The AC parameters are specified for following RC loads on the LIN bus: L1 = 1 k Ω / 1 nF; L2 = 660 Ω / 6.8 nF; L3 = 500 Ω / 10 nF.

29. Low slope mode is not compliant to the LIN standard.

REGULATOR TYPICAL PERFORMANCE CHARACTERISTICS – 3.3 V VERSION

Load Transient Responses

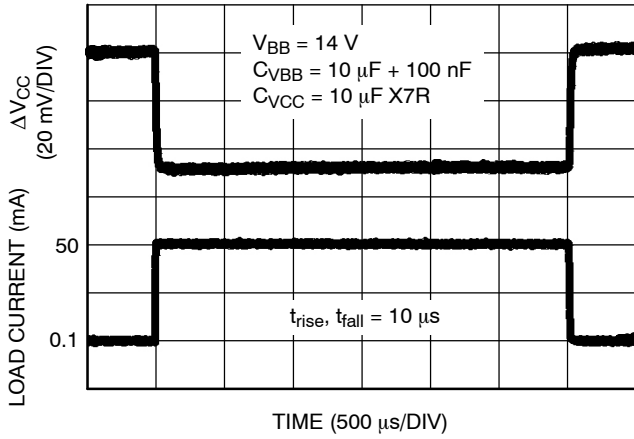

Figure 7. Load Transient Response
(Icc 100 µA to 50 mA)

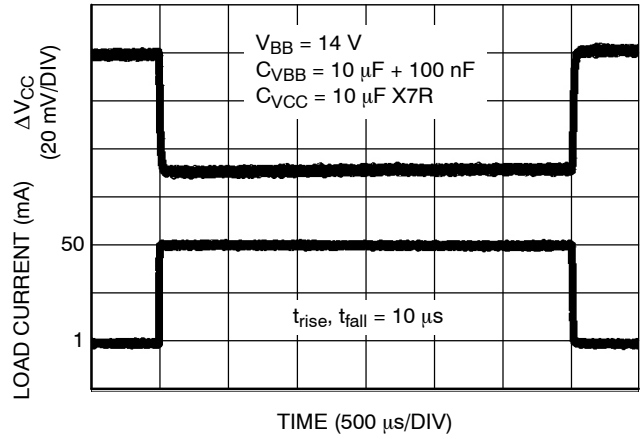

Figure 8. Load Transient Response
(Icc 1 mA to 50 mA)

Line Transient Responses

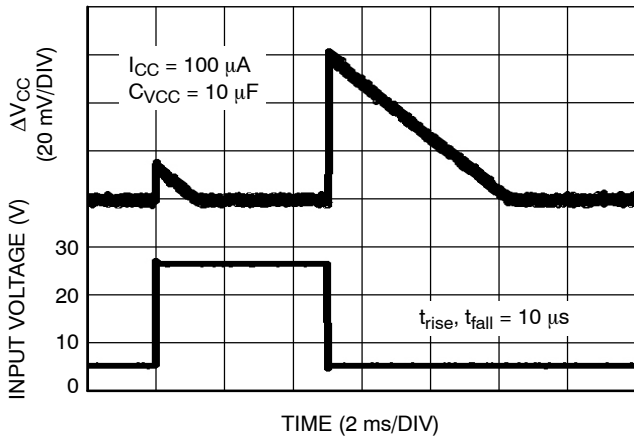

Figure 9. Line Transient Response
(Vbb 5 V to 26 V)

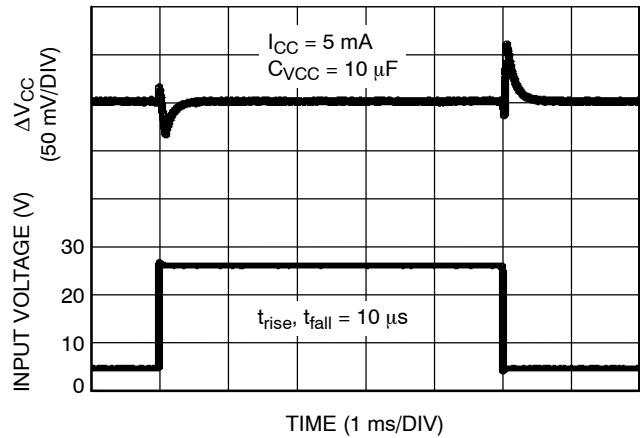

Figure 10. Line Transient Response
(Vbb 5 V to 26 V)

REGULATOR TYPICAL PERFORMANCE CHARACTERISTICS – 3.3 V VERSION

Static Characteristics

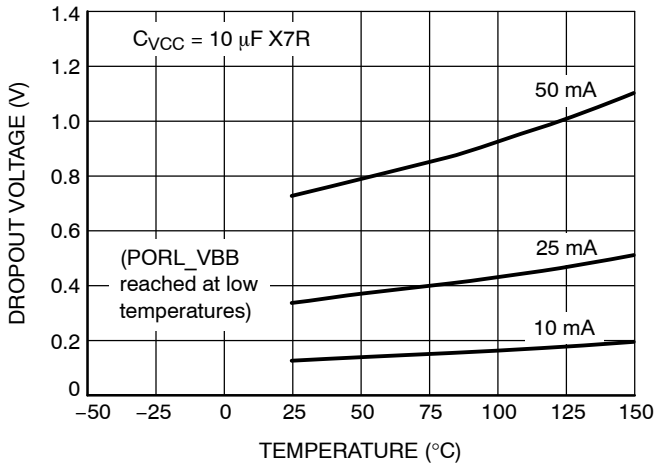

Figure 11. Dropout Voltage vs. Temperature

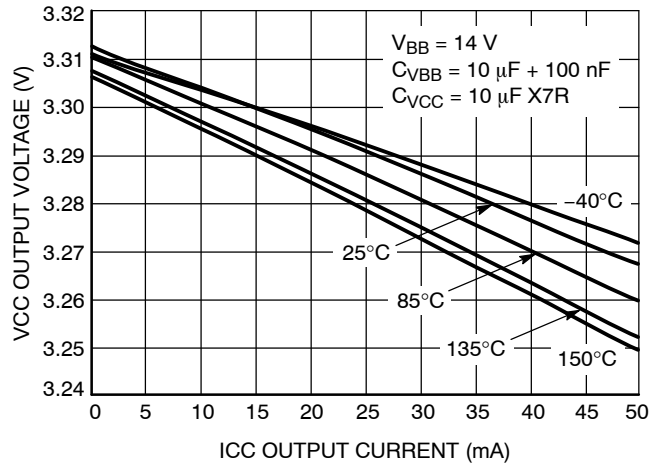

Figure 12. Output Voltage vs. Output Current

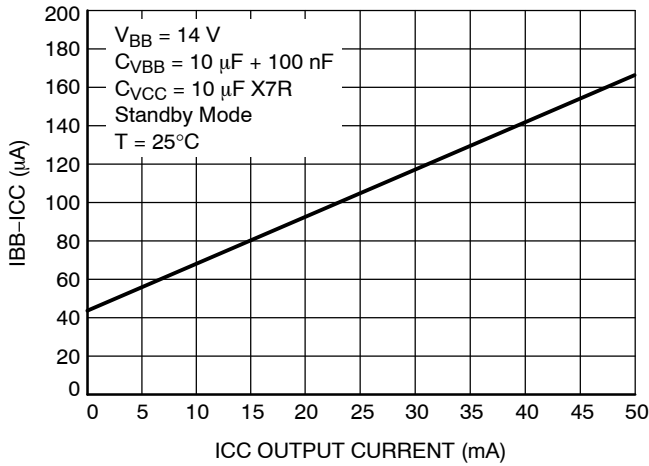

Figure 13. Ground Current vs. Output Current

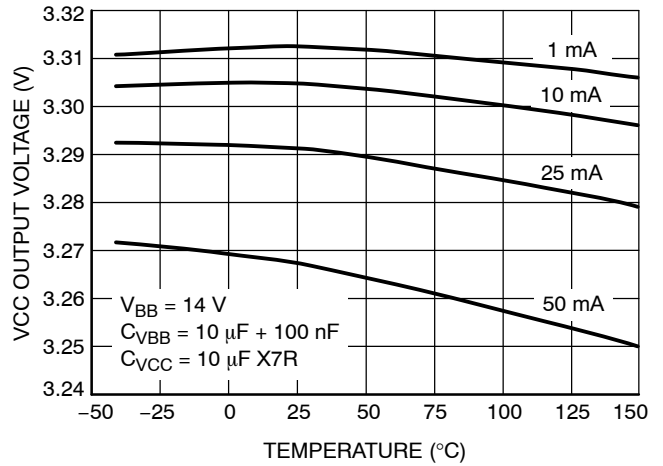

Figure 14. Output Voltage vs. Temperature

REGULATOR TYPICAL PERFORMANCE CHARACTERISTICS – 5 V VERSION

Load Transient Responses

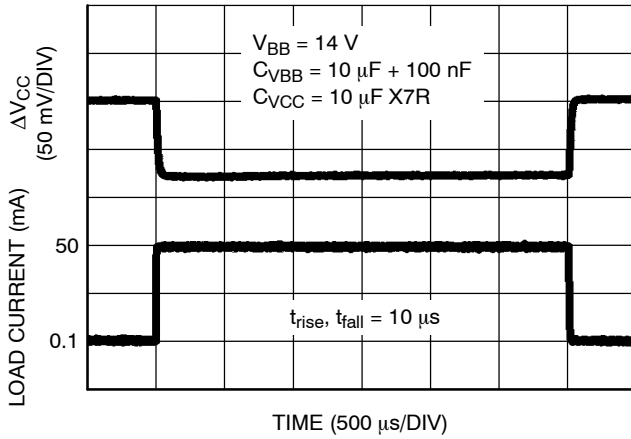

Figure 15. Load Transient Response
(Icc 100 µA to 50 mA)

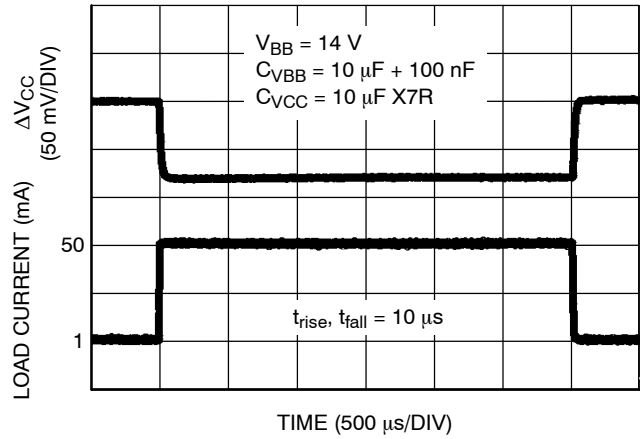

Figure 16. Load Transient Response
(Icc 1 mA to 50 mA)

Line Transient Responses

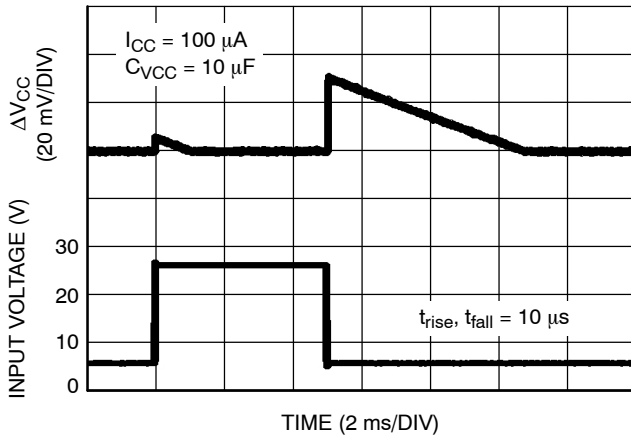

Figure 17. Line Transient Response
(Vbb 6 V to 26 V)

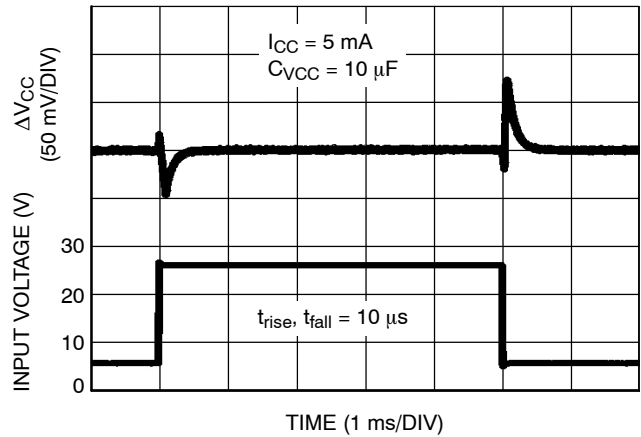

Figure 18. Line Transient Response
(Vbb 6 V to 26 V)

REGULATOR TYPICAL PERFORMANCE CHARACTERISTICS – 5 V VERSION

Static Characteristics

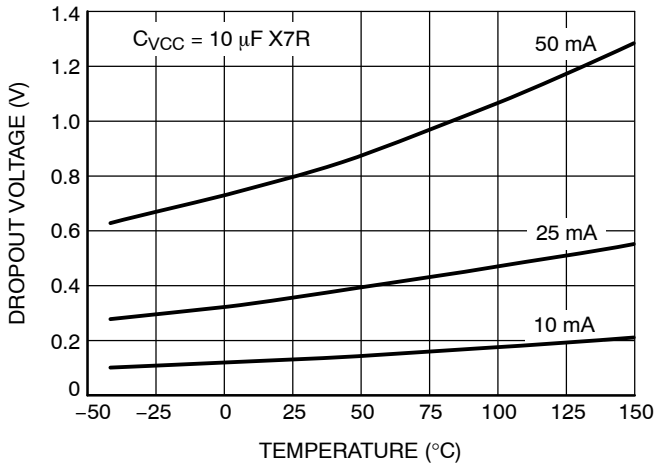

Figure 19. Dropout Voltage vs. Temperature

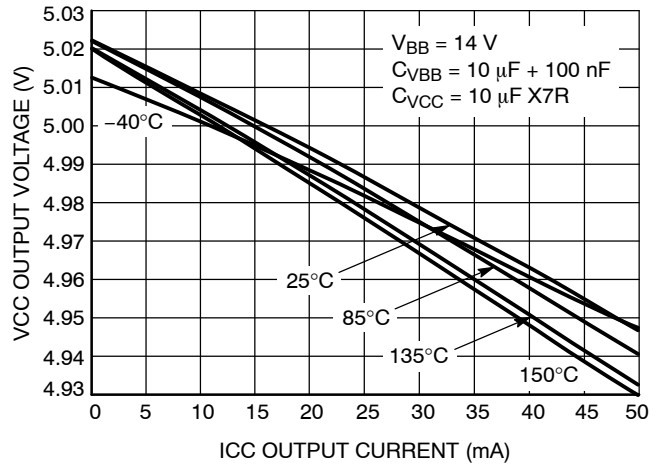

Figure 20. Output Voltage vs. Output Current

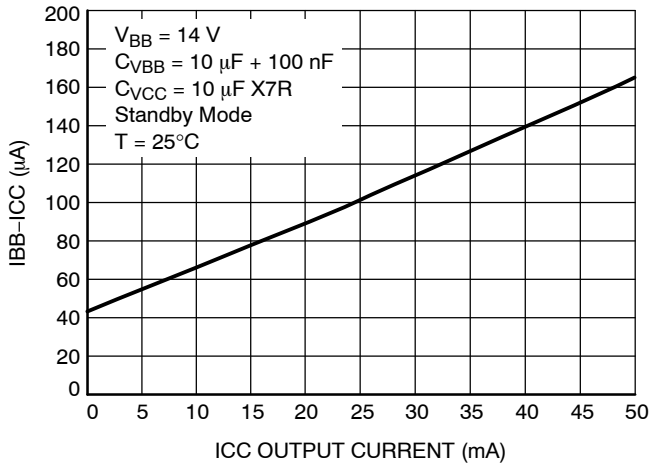

Figure 21. Ground Current vs. Output Current

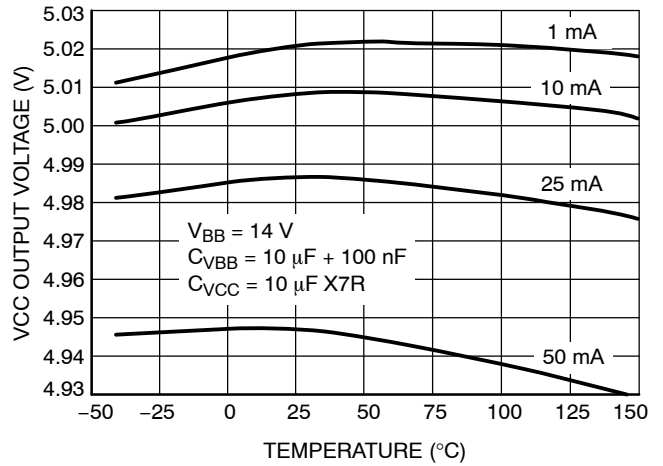

Figure 22. Output Voltage vs. Temperature

NCV7420

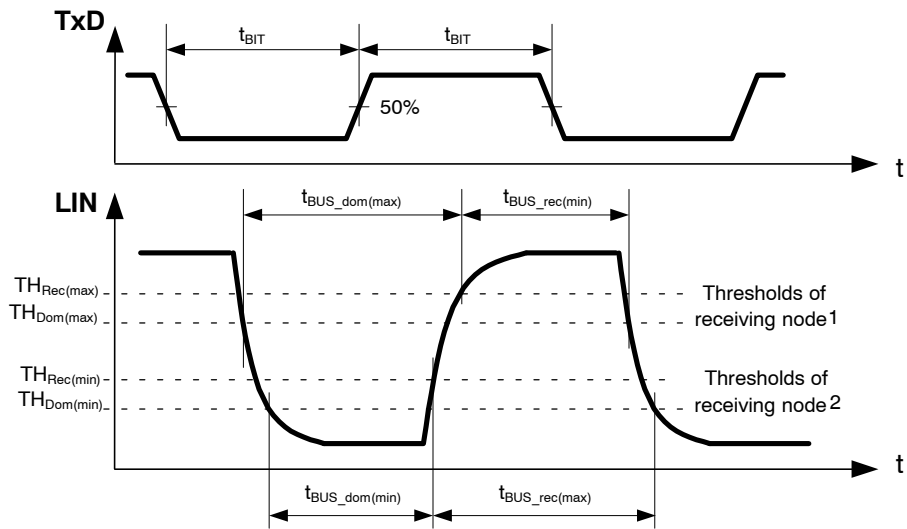

Figure 23. LIN Transmitter Duty Cycle

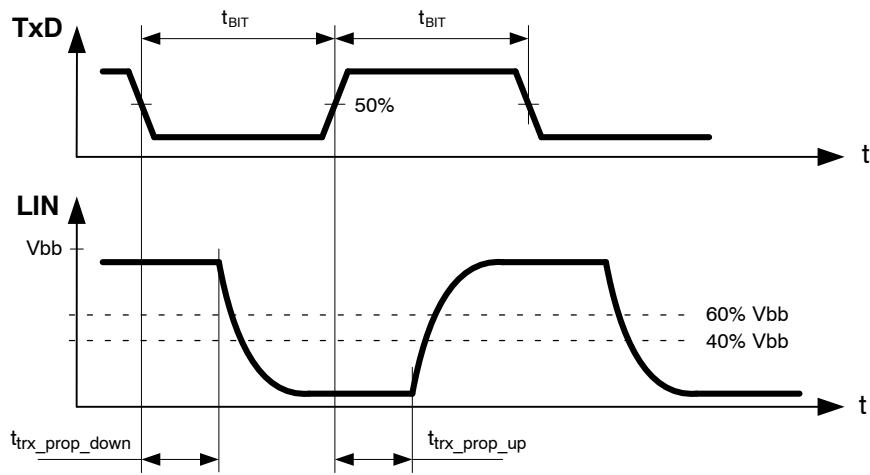

Figure 24. LIN Transmitter Timing

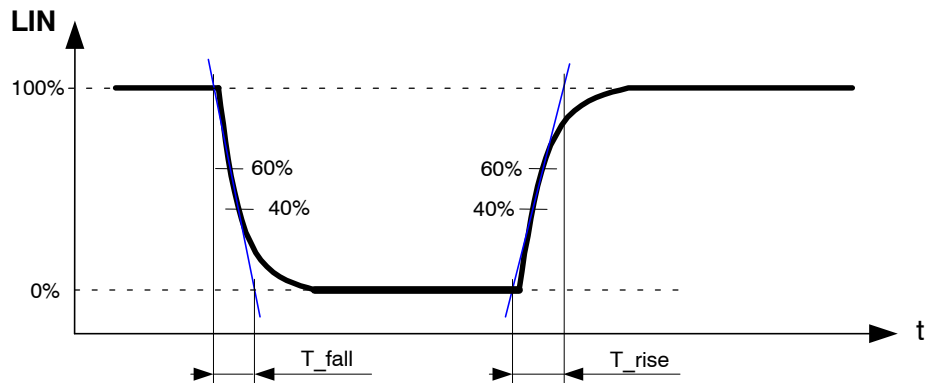

Figure 25. LIN Transmitter Rising and Falling Times

NCV7420

Table 20. AC CHARACTERISTICS LIN RECEIVER

Symbol Pin LIN	Parameter	Conditions	Min	Typ	Max	Unit
Trec_prop_down	Propagation delay of receiver falling edge		0.1		6	μs
Trec_prop_up	Propagation delay of receiver rising edge		0.1		6	μs
Trec_sym	Propagation delay symmetry	$T_{rec_prop_down} - T_{rec_prop_up}$	-2		2	μs

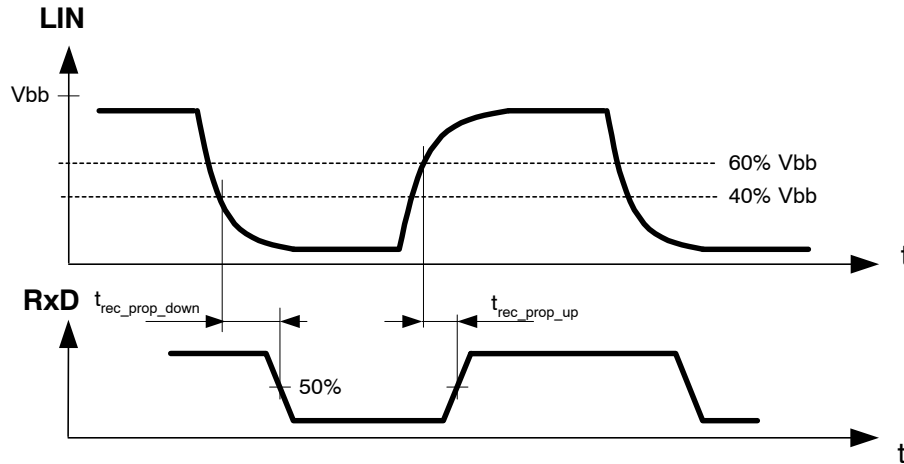

Figure 26. LIN Receiver Timing

ORDERING INFORMATION

Part Number	Description	Package	Container		Temperature Range
			Shipping [†]	Qty	
NCV7420D23G	LIN Transceiver + 3.3 V Vreg.	SOIC 150 14 GREEN (JEDEC MS-012)	Tube/Rail	55	-40°C to 125°C
NCV7420D23R2G	LIN Transceiver + 3.3 V Vreg.	SOIC 150 14 GREEN (JEDEC MS-012)	Tape & Reel	3000	-40°C to 125°C
NCV7420D24G	EMC/ESD Improved LIN Transceiver + 3.3 V Vreg.	SOIC 150 14 GREEN (JEDEC MS-012)	Tube/Rail	55	-40°C to 125°C
NCV7420D24R2G	EMC/ESD Improved LIN Transceiver + 3.3 V Vreg.	SOIC 150 14 GREEN (JEDEC MS-012)	Tape & Reel	3000	-40°C to 125°C
NCV7420D25G	LIN Transceiver + 5 V Vreg.	SOIC 150 14 GREEN (JEDEC MS-012)	Tube/Rail	55	-40°C to 125°C
NCV7420D25R2G	LIN Transceiver + 5 V Vreg.	SOIC 150 14 GREEN (JEDEC MS-012)	Tape & Reel	3000	-40°C to 125°C
NCV7420D26G	EMC/ESD Improved LIN Transceiver + 5 V Vreg.	SOIC 150 14 GREEN (JEDEC MS-012)	Tube/Rail	55	-40°C to 125°C
NCV7420D26R2G	EMC/ESD Improved LIN Transceiver + 5 V Vreg.	SOIC 150 14 GREEN (JEDEC MS-012)	Tape & Reel	3000	-40°C to 125°C

[†]For information on tape and reel specifications, including part orientation and tape sizes, please refer to our Tape and Reel Packaging Specifications Brochure, BRD8011/D.

NCV7420

PACKAGE DIMENSIONS

SOIC 14
CASE 751AP-01
ISSUE A

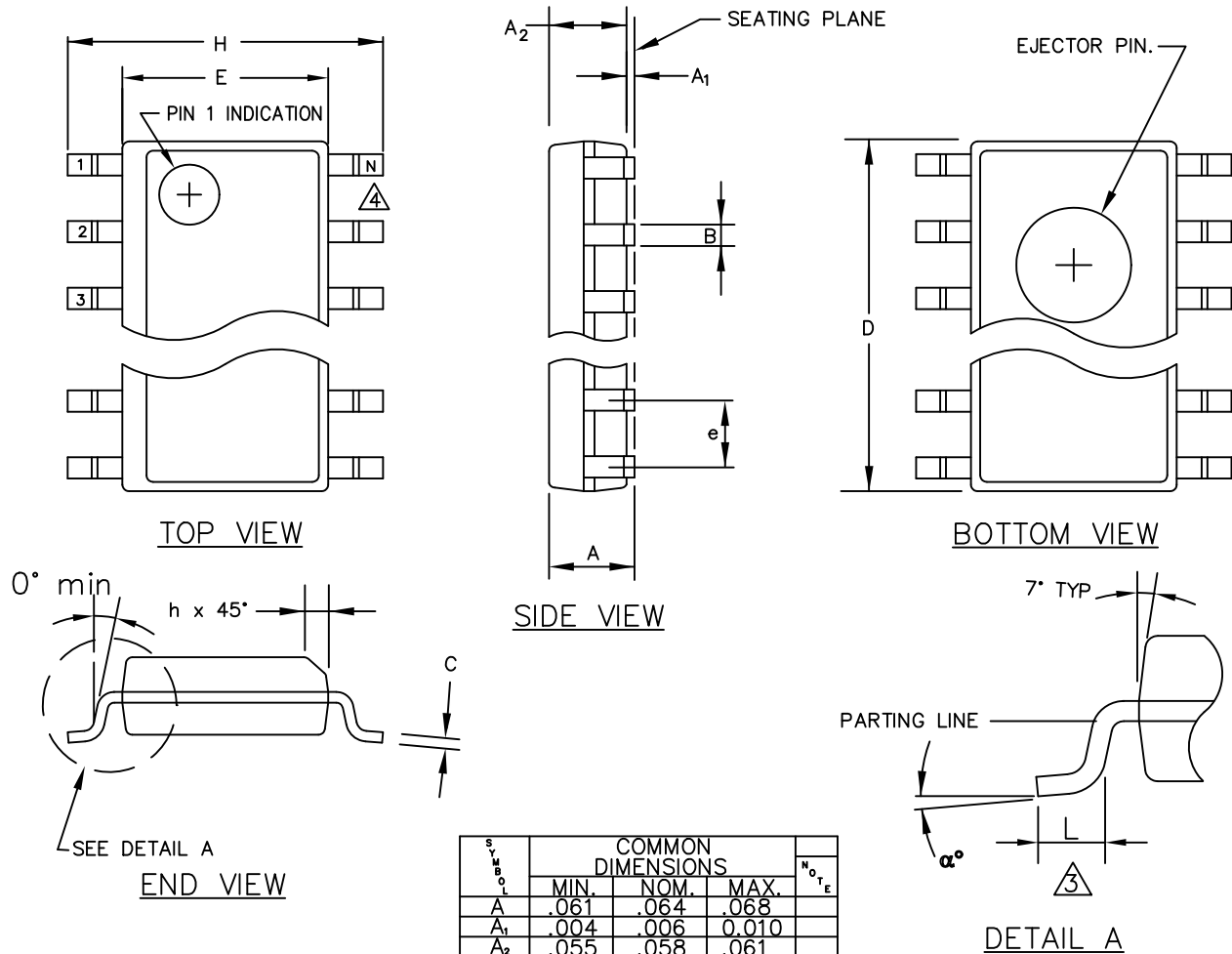

SYMBOL	COMMON DIMENSIONS			NOTE
	MIN.	NOM.	MAX.	
A	.061	.064	.068	
A ₁	.004	.006	0.010	
A ₂	.055	.058	.061	
B	.0138	.016	.020	
C	.0075	.008	.0098	
D	SEE VARIATIONS			1
E	.150	.155	.157	
e	.050 BSC			
H	.230	.236	.244	
h	.010	.013	.016	
L	.016	.025	.035	
N	SEE VARIATIONS			2
α°	0°	5°	8°	

VARIATIONS				
	1			2
	D			N
NOTE	MIN.	NOM.	MAX.	
AA	.189	.194	.196	8
AB	.337	.342	.344	14
AC	.386	.391	.393	16

ON Semiconductor and **ON** are registered trademarks of Semiconductor Components Industries, LLC (SCILLC). SCILLC reserves the right to make changes without further notice to any products herein. SCILLC makes no warranty, representation or guarantee regarding the suitability of its products for any particular purpose, nor does SCILLC assume any liability arising out of the application or use of any product or circuit, and specifically disclaims any and all liability, including without limitation special, consequential or incidental damages. "Typical" parameters which may be provided in SCILLC data sheets and/or specifications can and do vary in different applications and actual performance may vary over time. All operating parameters, including "Typicals" must be validated for each customer application by customer's technical experts. SCILLC does not convey any license under its patent rights nor the rights of others. SCILLC products are not designed, intended, or authorized for use as components in systems intended for surgical implant into the body, or other applications intended to support or sustain life, or for any other application in which the failure of the SCILLC product could create a situation where personal injury or death may occur. Should Buyer purchase or use SCILLC products for any such unintended or unauthorized application, Buyer shall indemnify and hold SCILLC and its officers, employees, subsidiaries, affiliates, and distributors harmless against all claims, costs, damages, and expenses, and reasonable attorney fees arising out of, directly or indirectly, any claim of personal injury or death associated with such unintended or unauthorized use, even if such claim alleges that SCILLC was negligent regarding the design or manufacture of the part. SCILLC is an Equal Opportunity/Affirmative Action Employer. This literature is subject to all applicable copyright laws and is not for resale in any manner.

PUBLICATION ORDERING INFORMATION

LITERATURE FULFILLMENT:

Literature Distribution Center for ON Semiconductor
P.O. Box 5163, Denver, Colorado 80217 USA
Phone: 303-675-2175 or 800-344-3860 Toll Free USA/Canada
Fax: 303-675-2176 or 800-344-3867 Toll Free USA/Canada
Email: orderlit@onsemi.com

N. American Technical Support: 800-282-9855 Toll Free
USA/Canada
Europe, Middle East and Africa Technical Support:
Phone: 421 33 790 2910
Japan Customer Focus Center
Phone: 81-3-5817-1050

ON Semiconductor Website: www.onsemi.com

Order Literature: <http://www.onsemi.com/orderlit>

For additional information, please contact your local
Sales Representative

Компания «Океан Электроники» предлагает заключение долгосрочных отношений при поставках импортных электронных компонентов на взаимовыгодных условиях!

Наши преимущества:

- Поставка оригинальных импортных электронных компонентов напрямую с производств Америки, Европы и Азии, а так же с крупнейших складов мира;
- Широкая линейка поставок активных и пассивных импортных электронных компонентов (более 30 млн. наименований);
- Поставка сложных, дефицитных, либо снятых с производства позиций;
- Оперативные сроки поставки под заказ (от 5 рабочих дней);
- Экспресс доставка в любую точку России;
- Помощь Конструкторского Отдела и консультации квалифицированных инженеров;
- Техническая поддержка проекта, помощь в подборе аналогов, поставка прототипов;
- Поставка электронных компонентов под контролем ВП;
- Система менеджмента качества сертифицирована по Международному стандарту ISO 9001;
- При необходимости вся продукция военного и аэрокосмического назначения проходит испытания и сертификацию в лаборатории (по согласованию с заказчиком);
- Поставка специализированных компонентов военного и аэрокосмического уровня качества (Xilinx, Altera, Analog Devices, Intersil, Interpoint, Microsemi, Actel, Aeroflex, Peregrine, VPT, Syfer, Eurofarad, Texas Instruments, MS Kennedy, Miteq, Cobham, E2V, MA-COM, Hittite, Mini-Circuits, General Dynamics и др.);

Компания «Океан Электроники» является официальным дистрибьютором и эксклюзивным представителем в России одного из крупнейших производителей разъемов военного и аэрокосмического назначения «JONHON», а так же официальным дистрибьютором и эксклюзивным представителем в России производителя высокотехнологичных и надежных решений для передачи СВЧ сигналов «FORSTAR».



JONHON

«JONHON» (основан в 1970 г.)

Разъемы специального, военного и аэрокосмического назначения:

(Применяются в военной, авиационной, аэрокосмической, морской, железнодорожной, горно- и нефтедобывающей отраслях промышленности)

«FORSTAR» (основан в 1998 г.)

ВЧ соединители, коаксиальные кабели,
кабельные сборки и микроволновые компоненты:

(Применяются в телекоммуникациях гражданского и специального назначения, в средствах связи, РЛС, а так же военной, авиационной и аэрокосмической отраслях промышленности).



Телефон: 8 (812) 309-75-97 (многоканальный)

Факс: 8 (812) 320-03-32

Электронная почта: ocean@oceanchips.ru

Web: <http://oceanchips.ru/>

Адрес: 198099, г. Санкт-Петербург, ул. Калинина, д. 2, корп. 4, лит. А