



## InGaP HBT 1 WATT POWER AMPLIFIER, 0.4 - 2.2 GHz

### Typical Applications

The HMC452ST89 / HMC452ST89E is ideal for applications requiring a high dynamic range amplifier:

- GSM, GPRS & EDGE
- CDMA & W-CDMA
- CATV/Cable Modem
- Fixed Wireless

### Features

- Output IP3: +49 dBm
- 21 dB Gain @ 400 MHz
- 9 dB Gain @ 2100 MHz
- 50% PAE @ +31 dBm Pout
- +25 dBm CDMA2000 Channel Power @ -45 dBc ACP
- Included in the HMC-DK002 Designer's Kit

### Functional Diagram



### General Description

The HMC452ST89 & HMC452ST89E are high dynamic range GaAs InGaP HBT 1 Watt MMIC power amplifiers operating from 0.4 to 2.2 GHz and packaged in industry standard SOT89 packages. Utilizing a minimum number of external components and a single +5V supply, the amplifier output IP3 can be optimized to +45 dBm at 0.4 GHz or +49 dBm at 2.1 GHz. The high output IP3 and PAE make the HMC452ST89 & HMC452ST89E ideal power amplifiers for Cellular/PCS/3G and Fixed Wireless applications.

### Electrical Specifications, $T_A = +25^\circ\text{C}$ , $V_S = +5\text{V}$ [1]

| Parameter                               | Min.      | Typ.  | Max. | Min.      | Typ.  | Max. | Min.      | Typ.  | Max. | Min.        | Typ.  | Max. | Min.        | Typ.  | Max. | Units   |
|---|-----------|-------|------|-----------|-------|------|-----------|-------|------|-------------|-------|------|-------------|-------|------|---------|
| Frequency Range                         | 400 - 410 |       |      | 450 - 496 |       |      | 810 - 960 |       |      | 1710 - 1990 |       |      | 2010 - 2170 |       |      | MHz     |
| Gain                                    | 19        | 21    |      | 18        | 20    |      | 13.5      | 15.5  |      | 7           | 9.5   |      | 7           | 9     |      | dB      |
| Gain Variation Over Temperature         |           | 0.012 | 0.02 |           | 0.012 | 0.02 |           | 0.012 | 0.02 |             | 0.012 | 0.02 |             | 0.012 | 0.02 | dB / °C |
| Input Return Loss                       |           | 22    |      |           | 16    |      |           | 13    |      |             | 13    |      |             | 20    |      | dB      |
| Output Return Loss                      |           | 11    |      |           | 11    |      |           | 14    |      |             | 15    |      |             | 15    |      | dB      |
| Output Power for 1dB Compression (P1dB) | 27        | 30    |      | 27        | 30    |      | 27.5      | 30.5  |      | 28          | 31    |      | 28.5        | 31.5  |      | dBm     |
| Saturated Output Power (Psat)           |           | 30.5  |      |           | 30.5  |      |           | 31.5  |      |             | 31.5  |      |             | 32    |      | dBm     |
| Output Third Order Intercept (IP3) [2]  | 42        | 45    |      | 42        | 45    |      | 44        | 47    |      | 45          | 48    |      | 46          | 49    |      | dBm     |
| Noise Figure                            |           | 6.5   |      |           | 7     |      |           | 6.5   |      |             | 6.5   |      |             | 6.5   |      | dB      |
| Supply Current (Icq)                    |           | 510   |      |           | 510   |      |           | 510   |      |             | 510   |      |             | 510   |      | mA      |

[1] Specifications and data reflect HMC452ST89 measured using the respective application circuits for each designated frequency band found herein. Contact the HMC Applications Group for assistance in optimizing performance for your application.

[2] Two-tone input power of 0 dBm per tone, 1 MHz spacing.

For price, delivery and to place orders: Hittite Microwave Corporation, 20 Alpha Road, Chelmsford, MA 01824

Phone: 978-250-3343 Fax: 978-250-3373 Order On-line at [www.hittite.com](http://www.hittite.com)

Application Support: Phone: 978-250-3343 or [apps@hittite.com](mailto:apps@hittite.com)



### Broadband Gain & Return Loss @ 400 MHz

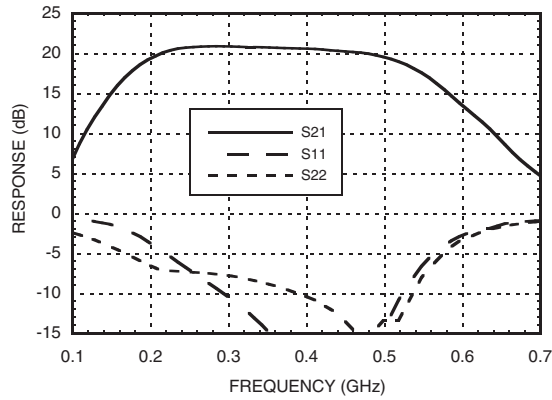

### Gain vs. Temperature @ 400 MHz

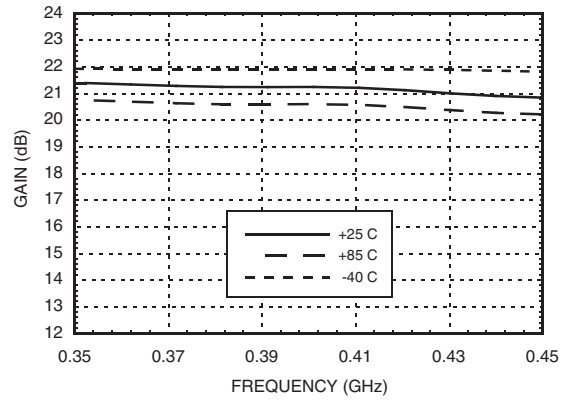

### Input Return Loss vs. Temperature @ 400 MHz

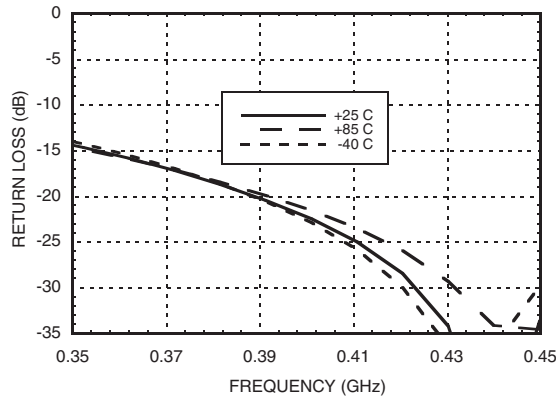

### Output Return Loss vs. Temperature @ 400 MHz

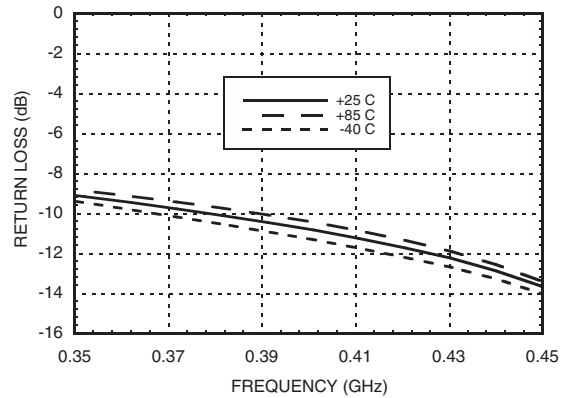

### P1dB vs. Temperature @ 400 MHz

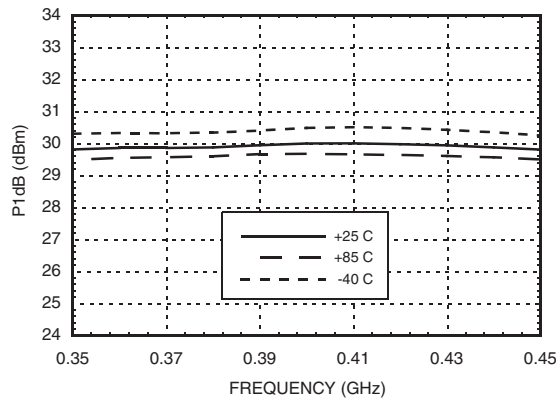

### Psat vs. Temperature @ 400 MHz

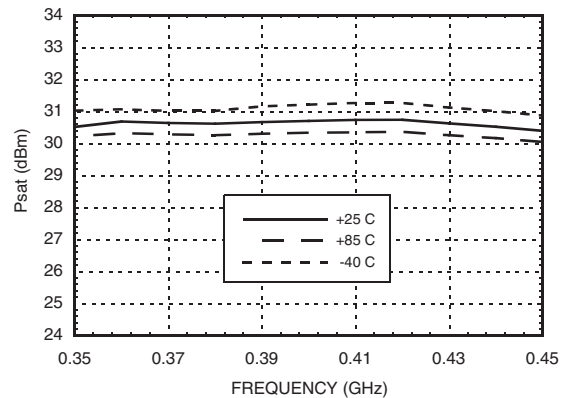

**Output IP3 vs. Temperature @ 400 MHz**



**Noise Figure vs. Temperature @ 400 MHz**

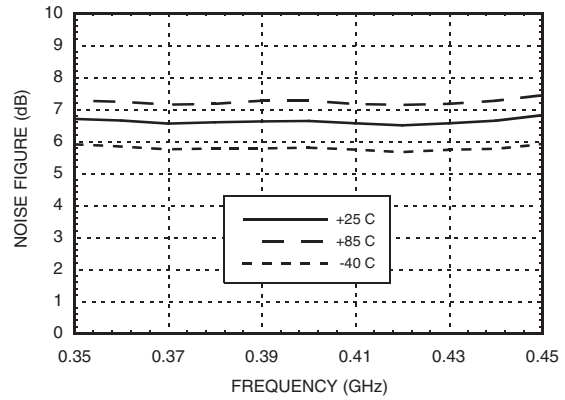

**Reverse Isolation vs. Temperature @ 400 MHz**



**Gain, Power & IP3 vs. Supply Voltage @ 400 MHz**

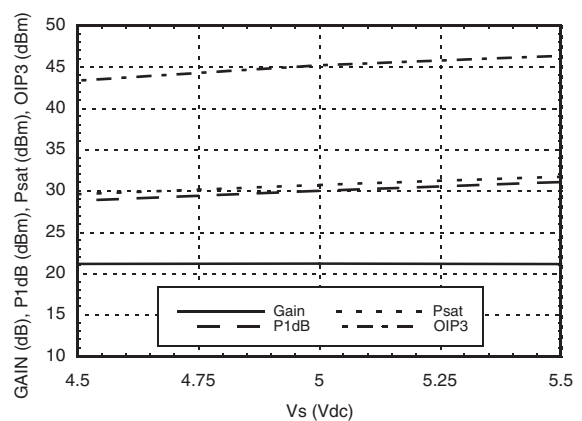

**Power Compression @ 400 MHz**



**ACPR vs. Supply Voltage @ 400 MHz W-CDMA, 64 DPCH**

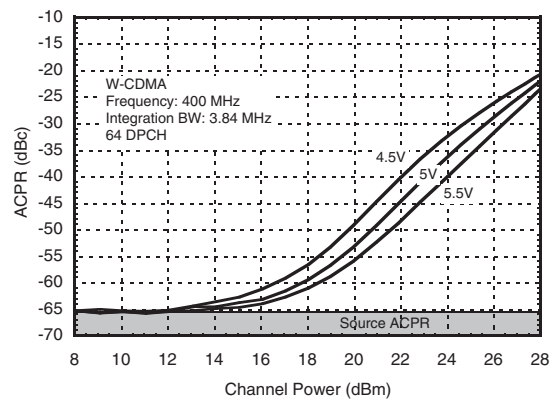



### Broadband Gain & Return Loss @ 470 MHz

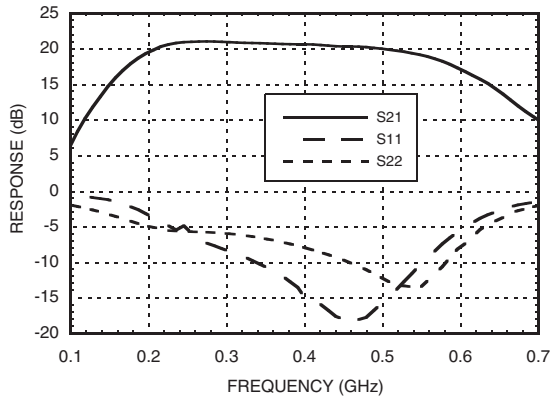

### Gain vs. Temperature @ 470 MHz

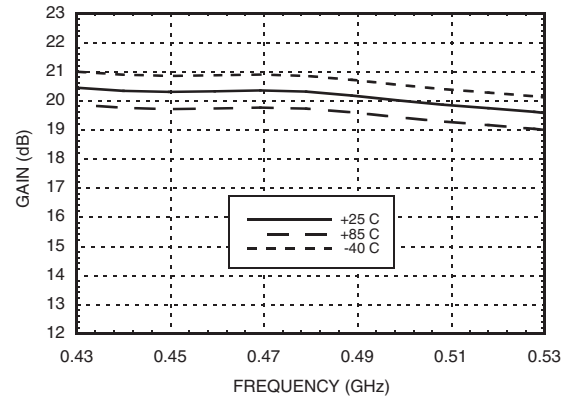

### Input Return Loss vs. Temperature @ 470 MHz



### Output Return Loss vs. Temperature @ 470 MHz

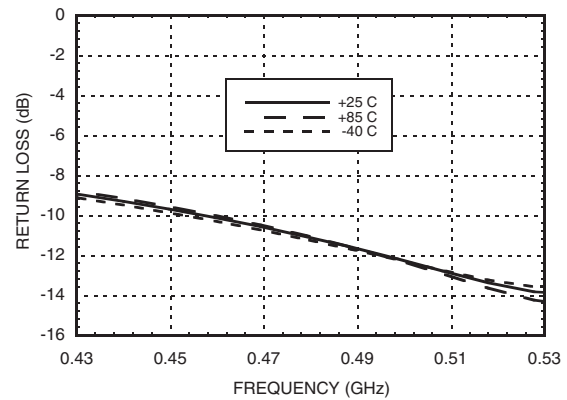

### P1dB vs. Temperature @ 470 MHz

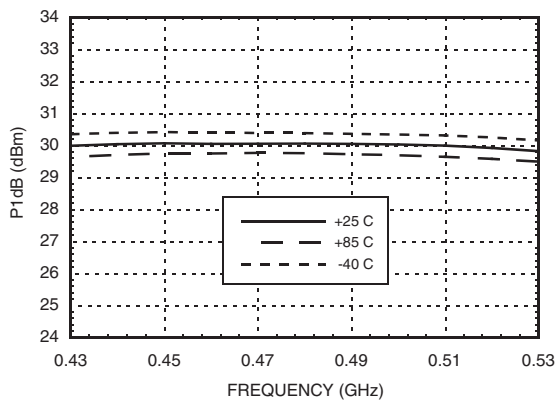

### Psat vs. Temperature @ 470 MHz

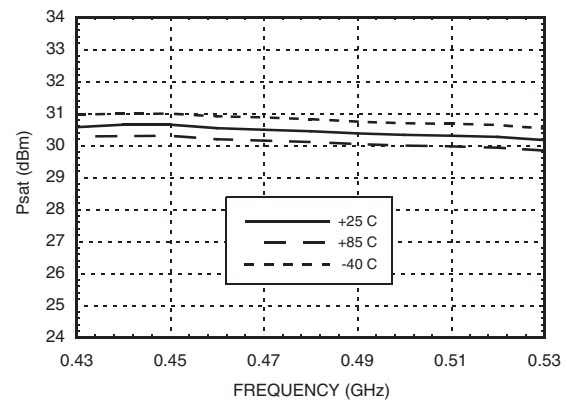

**Output IP3 vs. Temperature @ 470 MHz**

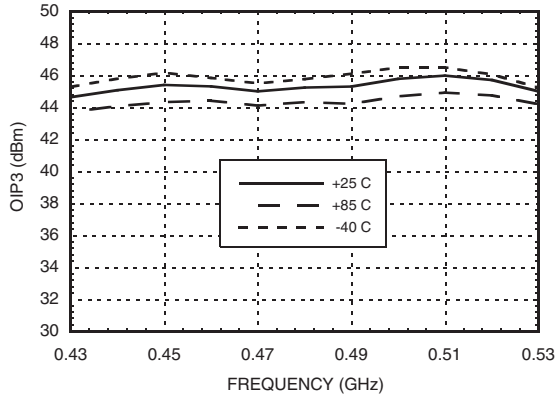

**Noise Figure vs. Temperature @ 470 MHz**

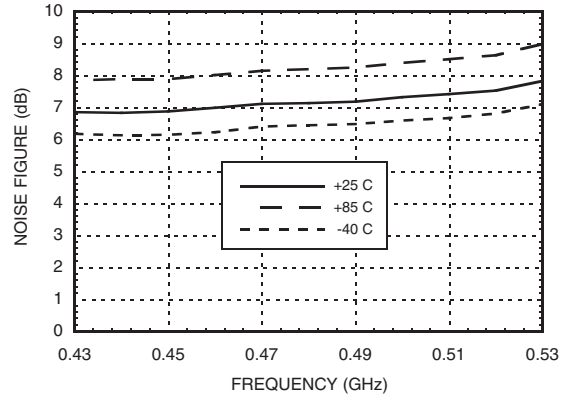

**Reverse Isolation vs. Temperature @ 470 MHz**

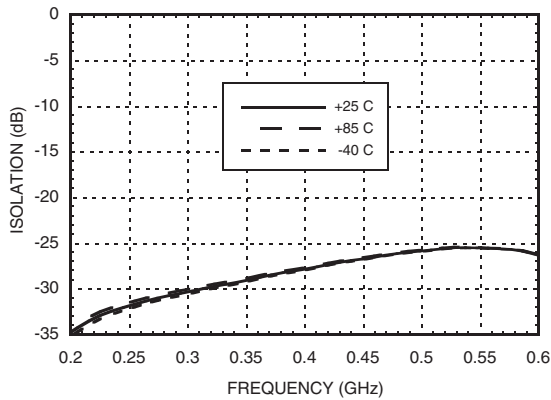

**Gain, Power & IP3 vs. Supply Voltage @ 470 MHz**

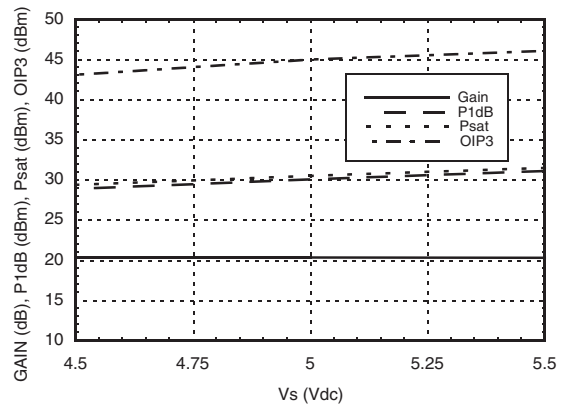

**Power Compression @ 470 MHz**

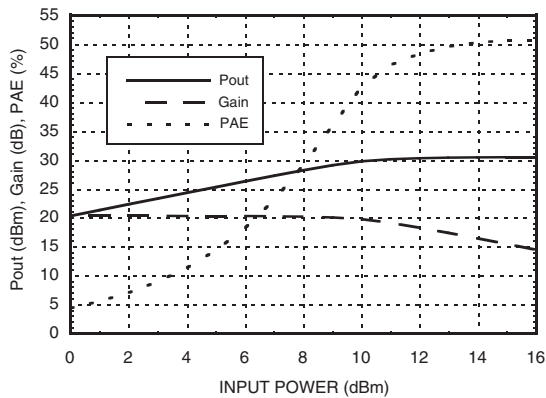

**ACPR vs. Supply Voltage @ 470 MHz W-CDMA, 64 DPCH**

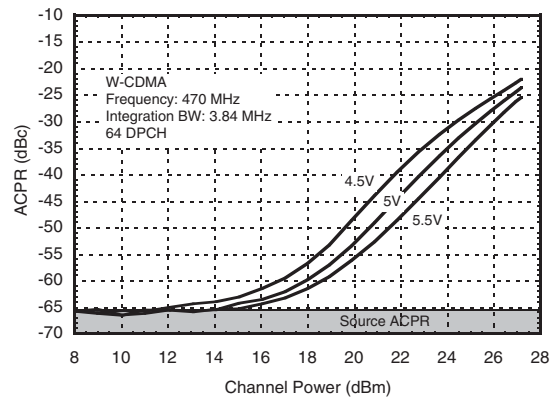



### Broadband Gain & Return Loss @ 900 MHz



### Gain vs. Temperature @ 900 MHz



### Input Return Loss vs. Temperature @ 900 MHz



### Output Return Loss vs. Temperature @ 900 MHz



### P1dB vs. Temperature @ 900 MHz



### Psat vs. Temperature @ 900 MHz





**Output IP3 vs. Temperature @ 900 MHz**



**Noise Figure vs. Temperature @ 900 MHz**



**Reverse Isolation vs. Temperature @ 900 MHz**



**Gain, Power & IP3 vs. Supply Voltage @ 900 MHz**



**Power Compression @ 900 MHz**

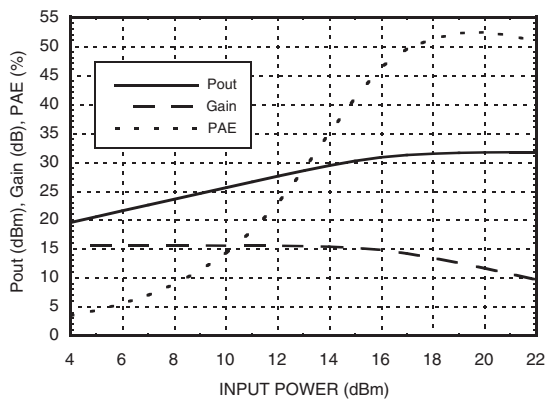

**ACPR vs. Supply Voltage @ 910 MHz CDMA IS95, 9 Channels Forward**

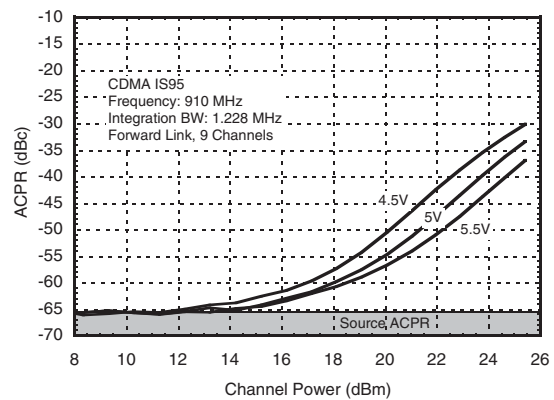



### Broadband Gain & Return Loss @ 1900 MHz

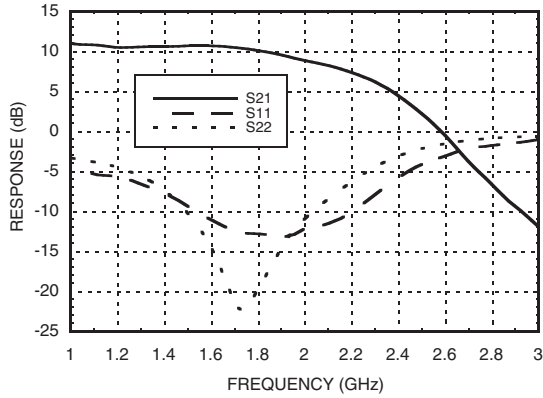

### Gain vs. Temperature @ 1900 MHz

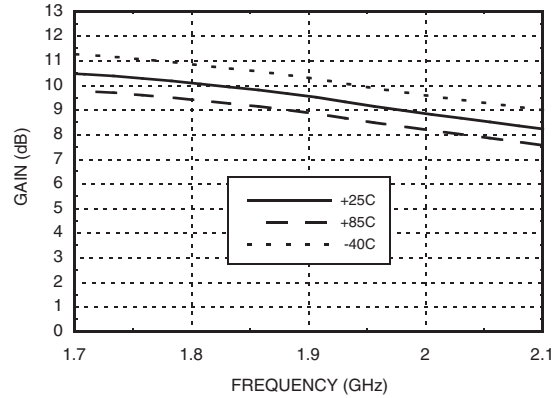

### Input Return Loss vs. Temperature @ 1900 MHz

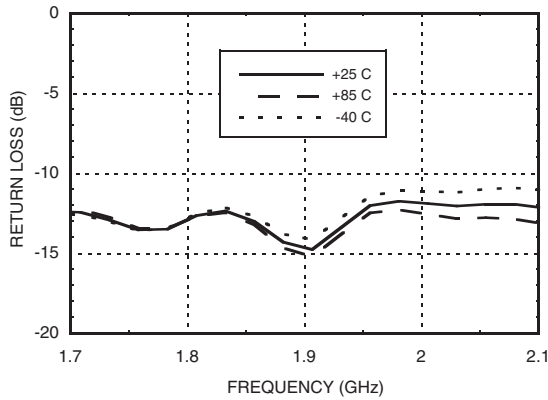

### Output Return Loss vs. Temperature @ 1900 MHz

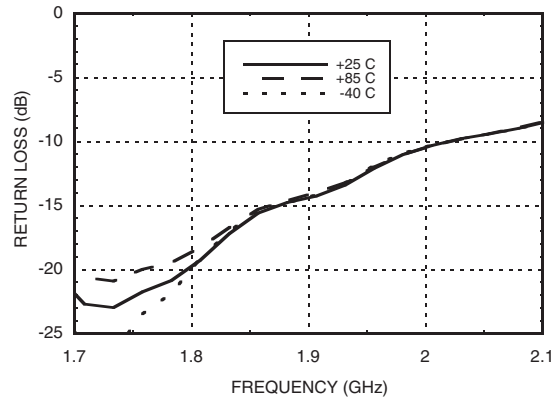

### P1dB vs. Temperature @ 1900 MHz

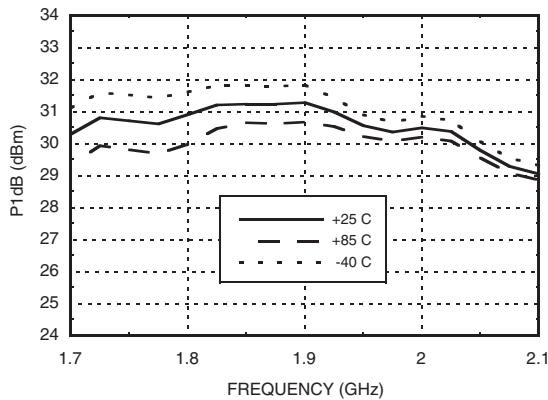

### Psat vs. Temperature @ 1900 MHz

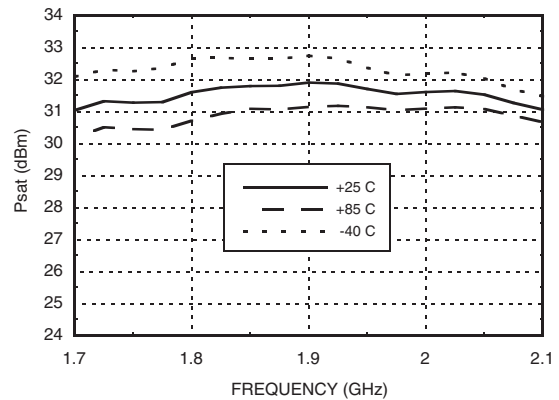





**Output IP3 vs. Temperature @ 1900 MHz**

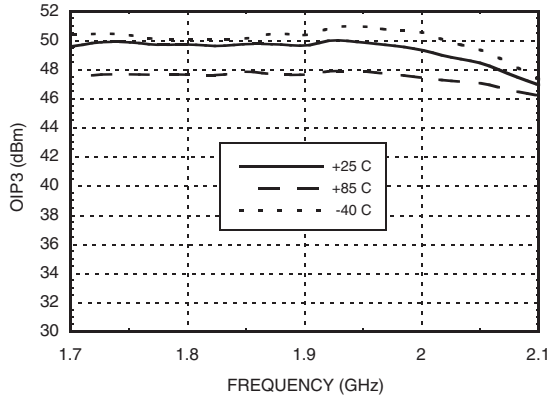

**Noise Figure vs. Temperature @ 1900 MHz**

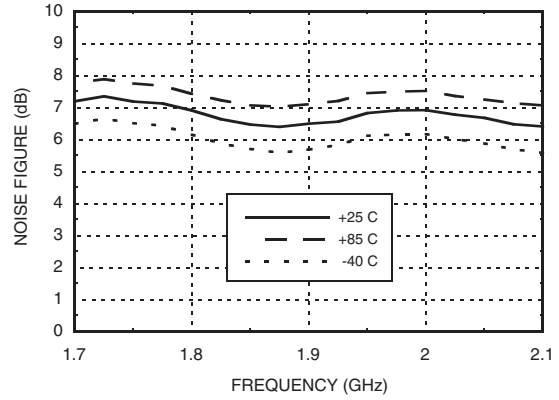

**Reverse Isolation vs. Temperature @ 1900 MHz**

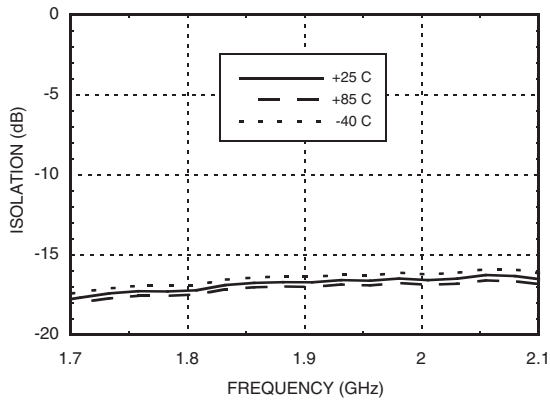

**Gain, Power & IP3 vs. Supply Voltage @ 1900 MHz**



**Power Compression @ 1900 MHz**



**ACPR vs. Supply Voltage @ 1960 MHz CDMA 2000, 9 Channels Forward**





### Broadband Gain & Return Loss @ 2100 MHz



### Gain vs. Temperature @ 2100 MHz



### Input Return Loss vs. Temperature @ 2100 MHz



### Output Return Loss vs. Temperature @ 2100 MHz



### P1dB vs. Temperature @ 2100 MHz



### Psat vs. Temperature @ 2100 MHz



**Output IP3 vs. Temperature @ 2100 MHz**



**Noise Figure vs. Temperature @ 2100 MHz**



**Reverse Isolation vs. Temperature @ 2100 MHz**



**Gain, Power & IP3 vs. Supply Voltage @ 2100 MHz**



**Power Compression @ 2100 MHz**



**ACPR vs. Supply Voltage @ 2140 MHz W-CDMA, 64 DPCH**





# HMC452ST89 / 452ST89E

## InGaP HBT 1 WATT POWER AMPLIFIER, 0.4 - 2.2 GHz

### Power Dissipation



### Absolute Maximum Ratings

|  |                |
|--|----------------|
| Collector Bias Voltage (Vcc)                                   | +6.0 Vdc       |
| RF Input Power (RFIN)(Vs +5Vdc)                                | +31 dBm        |
| Junction Temperature   | 150 °C         |
| Continuous Pdis (T = 85 °C)<br>(derate 41.5 mW/°C above 85 °C) | 2.7 W          |
| Thermal Resistance<br>(junction to ground paddle)              | 24.1 °C/W      |
| Storage Temperature  | -65 to +150 °C |
| Operating Temperature  | -40 to +85 °C  |
| ESD Sensitivity (HBM)  | Class 1A       |



ELECTROSTATIC SENSITIVE DEVICE  
OBSERVE HANDLING PRECAUTIONS

### Outline Drawing



#### NOTES:

- PACKAGE BODY MATERIAL:  
MOLDING COMPOUND MP-180S OR EQUIVALENT.
- LEAD MATERIAL: Cu w/ Ag SPOT PLATING.
- LEAD PLATING: 100% MATTE TIN.
- DIMENSIONS ARE IN INCHES [MILLIMETERS]
- $\Delta$  DIMENSION DOES NOT INCLUDE MOLDFLASH OF 0.15mm PER SIDE.
- $\Delta$  DIMENSION DOES NOT INCLUDE MOLDFLASH OF 0.25mm PER SIDE.
- ALL GROUND LEADS MUST BE SOLDERED TO PCB RF GROUND.

### Package Information

| Part Number | Package Body Material                              | Lead Finish   | MSL Rating          | Package Marking <sup>[3]</sup> |
|-------------|--|---------------|---------------------|--------------------------------|
| HMC452ST89  | Low Stress Injection Molded Plastic                | Sn/Pb Solder  | MSL1 <sup>[1]</sup> | H452<br>XXXX                   |
| HMC452ST89E | RoHS-compliant Low Stress Injection Molded Plastic | 100% matte Sn | MSL1 <sup>[2]</sup> | <u>H452</u><br>XXXX            |

[1] Max peak reflow temperature of 235 °C

[2] Max peak reflow temperature of 260 °C

[3] 4-Digit lot number XXXX

### Pin Descriptions

| Pin Number | Function | Description  | Interface Schematic |
|------------|----------|--|---------------------|
| 1          | RFIN     | This pin is DC coupled.<br>Off chip matching components are required.<br>See Application Circuit herein.                                     |                     |
| 3          | RFOUT    | RF output and DC Bias input for the output amplifier stage.<br>Off chip matching components are required.<br>See Application Circuit herein. |                     |
| 2, 4       | GND      | These pins & package bottom must be connected to RF/DC ground.   |                     |

### 400 MHz Application Circuit

This circuit was used to specify the performance for 400-410 MHz operation. Contact the HMC Applications Group for assistance in optimizing performance for your application.

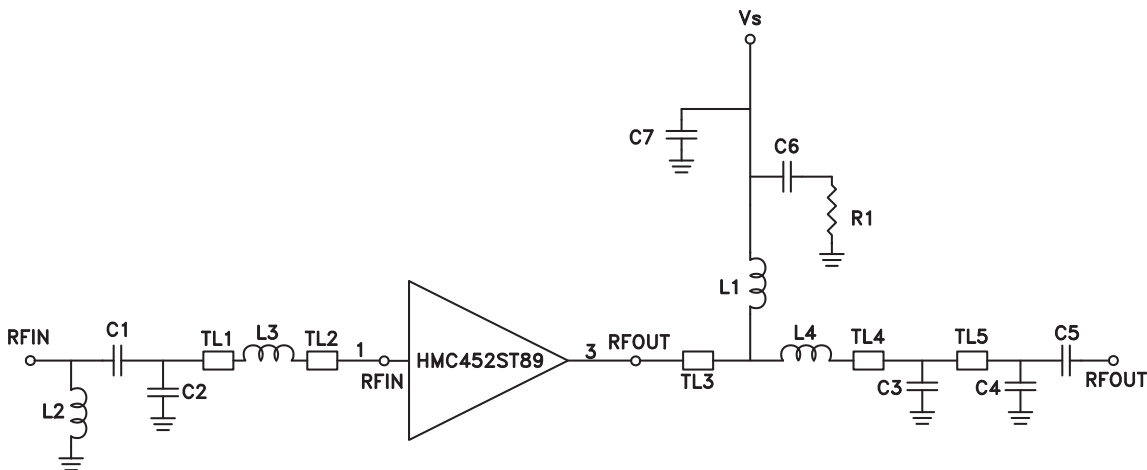

Note: C2 should be placed as close to pins as possible.

|   | TL1    | TL2    | TL3    | TL4    | TL5    |
|---|--------|--------|--------|--------|--------|
| Impedance                                   | 50 Ohm | 50 Ohm | 50 Ohm | 50 Ohm | 50 Ohm |
| Physical Length                             | 0.09"  | 0.08"  | 0.17"  | 0.04"  | 0.25"  |
| Electrical Length                           | 2°     | 2°     | 4°     | 1°     | 6°     |
| PCB Material: 10 mil Rogers 4350, Er = 3.48 |        |        |        |        |        |

| Recommended Component Values |         |
|------------------------------|---------|
| C1                           | 12 pF   |
| C2                           | 15 pF   |
| C3, C4                       | 6.8 pF  |
| C5                           | 39 pF   |
| C6                           | 100 pF  |
| C7                           | 2.2 μF  |
| L1                           | 47 nH   |
| L2                           | 40 nH   |
| L3                           | 4.3 nH  |
| L4                           | 5.1 nH  |
| R1                           | 5.1 Ohm |

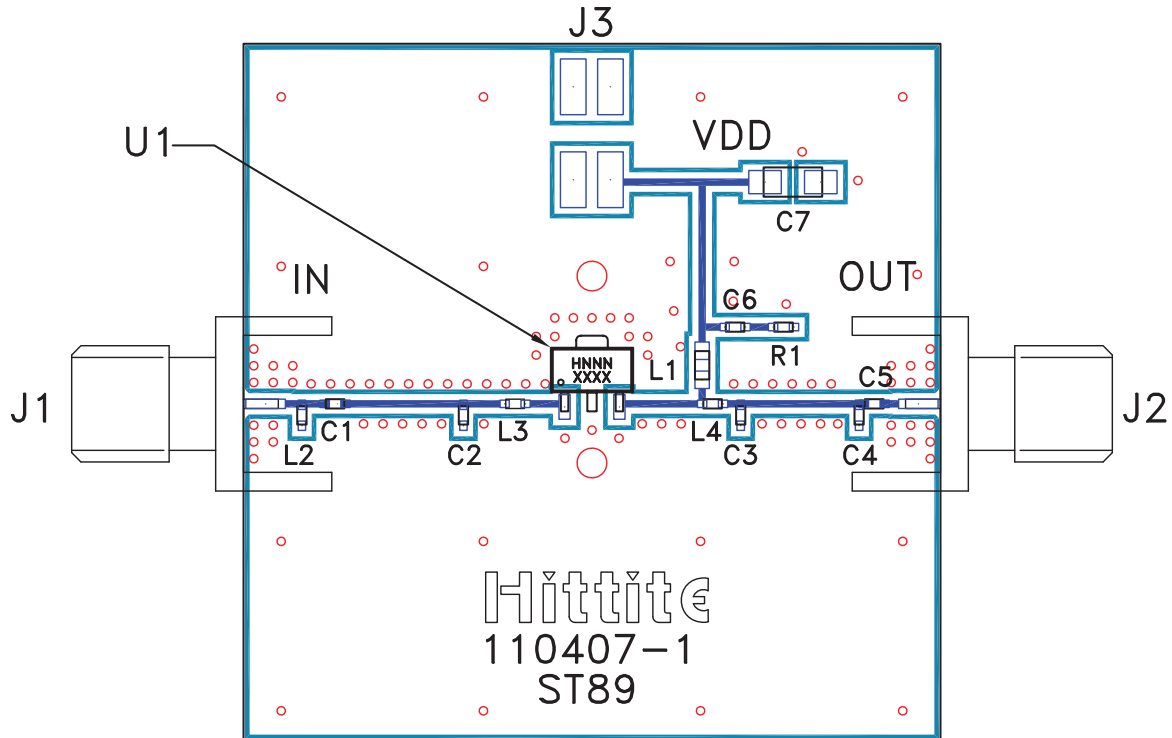
**400 MHz Evaluation PCB**

**List of Materials for Evaluation PCB 110409-400 [1]**

| Item    | Description                         |
|---------|-------------------------------------|
| J1 - J2 | PCB Mount SMA Connector             |
| J3      | 2 mm DC Header                      |
| C1      | 12 pF Capacitor, 0402 Pkg.          |
| C2      | 15 pF Capacitor, 0402 Pkg.          |
| C3, C4  | 6.8 pF Capacitor, 0402 Pkg.         |
| C5      | 39 pF Capacitor, 0402 Pkg.          |
| C6      | 100 pF Capacitor, 0402 Pkg.         |
| C7      | 2.2 $\mu$ F Capacitor, Tantalum     |
| L1      | 47 nH Inductor, 0603 Pkg.           |
| L2      | 40 nH Inductor, 0402 Pkg.           |
| L3      | 4.3 nH Inductor, 0402 Pkg.          |
| L4      | 5.1 nH Inductor, 0402 Pkg.          |
| R1      | 5.1 Ohm Resistor, 0402 Pkg.         |
| U1      | HMC452ST89 / HMC452ST89E Linear Amp |
| PCB [2] | 110407 Evaluation PCB, 10 mils      |

[1] Reference this number when ordering complete evaluation PCB

[2] Circuit Board Material: Rogers 4350, Er = 3.48

The circuit board used in this application should use RF circuit design techniques. Signal lines should have 50 Ohm impedance while the package ground leads and exposed paddle should be connected directly to the ground plane similar to that shown. A sufficient number of via holes should be used to connect the top and bottom ground planes. The evaluation board should be mounted to an appropriate heat sink. The evaluation circuit board shown is available from Hittite upon request.

### 470 MHz Application Circuit

This circuit was used to specify the performance for 450-496 MHz operation. Contact the HMC Applications Group for assistance in optimizing performance for your application.



Note: C2 should be placed as close to pins as possible.

|   | TL1    | TL2    | TL3    | TL4    | TL5    |
|---|--------|--------|--------|--------|--------|
| Impedance                                   | 50 Ohm | 50 Ohm | 50 Ohm | 50 Ohm | 50 Ohm |
| Physical Length                             | 0.09"  | 0.08"  | 0.17"  | 0.04"  | 0.25"  |
| Electrical Length                           | 2.5°   | 2°     | 5°     | 1°     | 7°     |
| PCB Material: 10 mil Rogers 4350, Er = 3.48 |        |        |        |        |        |

| Recommended Component Values |         |
|------------------------------|---------|
| C1, C2                       | 12 pF   |
| C3                           | 6.8 pF  |
| C4                           | 5.6 pF  |
| C5                           | 39 pF   |
| C6                           | 100 pF  |
| C7                           | 2.2 μF  |
| L1                           | 47 nH   |
| L2                           | 40 nH   |
| L3                           | 4.7 nH  |
| L4                           | 3.9 nH  |
| R1                           | 5.1 Ohm |

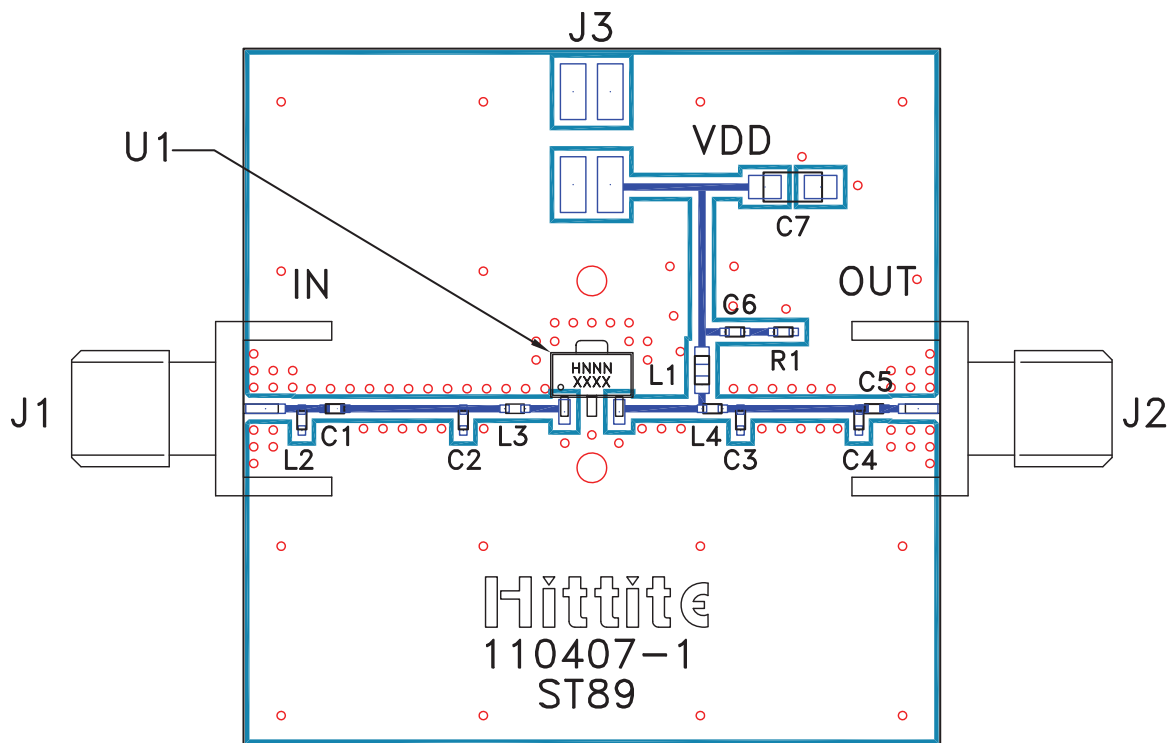
**470 MHz Evaluation PCB**

**List of Materials for Evaluation PCB 110416-470 [1]**

| Item    | Description                         |
|---------|-------------------------------------|
| J1 - J2 | PCB Mount SMA Connector             |
| J3      | 2 mm DC Header                      |
| C1, C2  | 12 pF Capacitor, 0402 Pkg.          |
| C3      | 6.8 pF Capacitor, 0402 Pkg.         |
| C4      | 5.6 pF Capacitor, 0402 Pkg.         |
| C5      | 39 pF Capacitor, 0402 Pkg.          |
| C6      | 100 pF Capacitor, 0402 Pkg.         |
| C7      | 2.2 $\mu$ F Capacitor, Tantalum     |
| L1      | 47 nH Inductor, 0603 Pkg.           |
| L2      | 40 nH Inductor, 0402 Pkg.           |
| L3      | 4.7 nH Inductor, 0402 Pkg.          |
| L4      | 3.9 nH Inductor, 0402 Pkg.          |
| R1      | 5.1 Ohm Resistor, 0402 Pkg.         |
| U1      | HMC452ST89 / HMC452ST89E Linear Amp |
| PCB [2] | 110407 Evaluation PCB, 10 mils      |

[1] Reference this number when ordering complete evaluation PCB

[2] Circuit Board Material: Rogers 4350, Er = 3.48

The circuit board used in this application should use RF circuit design techniques. Signal lines should have 50 Ohm impedance while the package ground leads and exposed paddle should be connected directly to the ground plane similar to that shown. A sufficient number of via holes should be used to connect the top and bottom ground planes. The evaluation board should be mounted to an appropriate heat sink. The evaluation circuit board shown is available from Hittite upon request.





### 900 MHz Application Circuit

This circuit was used to specify the performance for 810-960 MHz operation. Contact the HMC Applications Group for assistance in optimizing performance for your application.



Note: C2 should be placed as close to pins as possible.

|   | TL1    | TL2    | TL3    |
|---|--------|--------|--------|
| Impedance                                   | 50 Ohm | 50 Ohm | 50 Ohm |
| Physical Length                             | 0.21"  | 0.13"  | 0.38"  |
| Electrical Length                           | 11°    | 7°     | 20°    |
| PCB Material: 10 mil Rogers 4350, Er = 3.48 |        |        |        |

| Recommended Component Values |         |
|------------------------------|---------|
| C1                           | 27 pF   |
| C2                           | 6.8 pF  |
| C3                           | 2.2 pF  |
| C4                           | 4.7 pF  |
| C5                           | 5.6 pF  |
| C6                           | 100 pF  |
| C7                           | 2.2 μF  |
| L1                           | 20 nH   |
| R1                           | 5.1 Ohm |

### 900 MHz Evaluation PCB



### List of Materials for Evaluation PCB 110384-900 <sup>[1]</sup>

| Item               | Description                            |
|--------------------|--|
| J1 - J2            | PCB Mount SMA Connector                |
| J3                 | 2 mm DC Header                         |
| C1                 | 27 pF Capacitor, 0402 Pkg.             |
| C2                 | 6.8 pF Capacitor, 0402 Pkg.            |
| C3                 | 2.2 pF Capacitor, 0402 Pkg.            |
| C4                 | 4.7 pF Capacitor, 0402 Pkg.            |
| C5                 | 5.6 pF Capacitor, 0402 Pkg.            |
| C6                 | 100 pF Capacitor, 0402 Pkg.            |
| C7                 | 2.2 $\mu$ F Capacitor, Tantalum        |
| L1                 | 20 nH Inductor, 0402 Pkg.              |
| R1                 | 5.1 Ohm Resistor, 0402 Pkg.            |
| U1                 | HMC452ST89 / HMC452ST89E<br>Linear Amp |
| PCB <sup>[2]</sup> | 110382 Evaluation PCB, 10 mils         |

[1] Reference this number when ordering complete evaluation PCB

[2] Circuit Board Material: Rogers 4350, Er = 3.48

The circuit board used in this application should use RF circuit design techniques. Signal lines should have 50 Ohm impedance while the package ground leads and exposed paddle should be connected directly to the ground plane similar to that shown. A sufficient number of via holes should be used to connect the top and bottom ground planes. The evaluation board should be mounted to an appropriate heat sink. The evaluation circuit board shown is available from Hittite upon request.



### 1900 MHz Application Circuit

This circuit was used to specify the performance for 1710-1990 MHz operation. Contact the HMC Applications Group for assistance in optimizing performance for your application.



Note: C2 should be placed as close to pins as possible.

|   | TL1    | TL2    |
|---|--------|--------|
| Impedance                                   | 50 Ohm | 50 Ohm |
| Physical Length                             | 0.04"  | 0.10"  |
| Electrical Length                           | 4°     | 11°    |
| PCB Material: 10 mil Rogers 4350, Er = 3.48 |        |        |

| Recommended Component Values |         |
|------------------------------|---------|
| C1                           | 3 pF    |
| C2                           | 2 pF    |
| C3                           | 3.3 pF  |
| C4                           | 15 pF   |
| C5                           | 100 pF  |
| C6                           | 2.2 μF  |
| L1                           | 10 nH   |
| L2                           | 12 nH   |
| R1                           | 5.1 Ohm |



**1900 MHz Evaluation PCB**



**List of Materials for Evaluation PCB 108712-1900 [1]**

| Item    | Description                         |
|---------|-------------------------------------|
| J1 - J2 | PCB Mount SMA Connector             |
| J3      | 2 mm DC Header                      |
| C1      | 3 pF Capacitor, 0402 Pkg.           |
| C2      | 2 pF Capacitor, 0402 Pkg.           |
| C3      | 3.3 pF Capacitor, 0402 Pkg.         |
| C4      | 15 pF Capacitor, 0402 Pkg.          |
| C5      | 100 pF Capacitor, 0402 Pkg.         |
| C6      | 2.2 $\mu$ F Capacitor, Tantalum     |
| L1      | 10 nH Inductor, 0402 Pkg.           |
| L2      | 12 nH Inductor, 0402 Pkg.           |
| R1      | 5.1 Ohm Resistor, 0402 Pkg.         |
| U1      | HMC452ST89 / HMC452ST89E Linear Amp |
| PCB [2] | 108710 Evaluation PCB, 10 mils      |

[1] Reference this number when ordering complete evaluation PCB

[2] Circuit Board Material: Rogers 4350, Er = 3.48

The circuit board used in this application should use RF circuit design techniques. Signal lines should have 50 Ohm impedance while the package ground leads and exposed paddle should be connected directly to the ground plane similar to that shown. A sufficient number of via holes should be used to connect the top and bottom ground planes. The evaluation board should be mounted to an appropriate heat sink. The evaluation circuit board shown is available from Hittite upon request.

### 2100 MHz Application Circuit

This circuit was used to specify the performance for 2010-2170 MHz operation. Contact the HMC Applications Group for assistance in optimizing performance for your application.



|   | TL1    | TL2    |
|---|--------|--------|
| Impedance                                   | 50 Ohm | 50 Ohm |
| Physical Length                             | 0.04"  | 0.04"  |
| Electrical Length                           | 5°     | 5°     |
| PCB Material: 10 mil Rogers 4350, Er = 3.48 |        |        |

| Recommended Component Values |         |
|------------------------------|---------|
| C1                           | 3 pF    |
| C2                           | 2 pF    |
| C3                           | 3.3 pF  |
| C4                           | 15 pF   |
| C5                           | 100 pF  |
| C6                           | 2.2 μF  |
| L1                           | 12 nH   |
| L2                           | 10 nH   |
| R1                           | 5.1 Ohm |

**2100 MHz Evaluation PCB**



**List of Materials for Evaluation PCB 109824-2100 [1]**

| Item    | Description                         |
|---------|-------------------------------------|
| J1 - J2 | PCB Mount SMA Connector             |
| J3      | 2 mm DC Header                      |
| C1      | 3 pF Capacitor, 0402 Pkg.           |
| C2      | 2 pF Capacitor, 0402 Pkg.           |
| C3      | 3.3 pF Capacitor, 0402 Pkg.         |
| C4      | 15 pF Capacitor, 0402 Pkg.          |
| C5      | 100 pF Capacitor, 0402 Pkg.         |
| C6      | 2.2 $\mu$ F Capacitor, Tantalum     |
| L1      | 12 nH Inductor, 0402 Pkg.           |
| L2      | 10 nH Inductor, 0402 Pkg.           |
| R1      | 5.1 Ohm Resistor, 0402 Pkg.         |
| U1      | HMC452ST89 / HMC452ST89E Linear Amp |
| PCB [2] | 109822 Evaluation PCB, 10 mils      |

[1] Reference this number when ordering complete evaluation PCB

[2] Circuit Board Material: Rogers 4350, Er = 3.48

The circuit board used in this application should use RF circuit design techniques. Signal lines should have 50 Ohm impedance while the package ground leads and exposed paddle should be connected directly to the ground plane similar to that shown. A sufficient number of via holes should be used to connect the top and bottom ground planes. The evaluation board should be mounted to an appropriate heat sink. The evaluation circuit board shown is available from Hittite upon request.

Компания «Океан Электроники» предлагает заключение долгосрочных отношений при поставках импортных электронных компонентов на взаимовыгодных условиях!

Наши преимущества:

- Поставка оригинальных импортных электронных компонентов напрямую с производств Америки, Европы и Азии, а так же с крупнейших складов мира;
- Широкая линейка поставок активных и пассивных импортных электронных компонентов (более 30 млн. наименований);
- Поставка сложных, дефицитных, либо снятых с производства позиций;
- Оперативные сроки поставки под заказ (от 5 рабочих дней);
- Экспресс доставка в любую точку России;
- Помощь Конструкторского Отдела и консультации квалифицированных инженеров;
- Техническая поддержка проекта, помощь в подборе аналогов, поставка прототипов;
- Поставка электронных компонентов под контролем ВП;
- Система менеджмента качества сертифицирована по Международному стандарту ISO 9001;
- При необходимости вся продукция военного и аэрокосмического назначения проходит испытания и сертификацию в лаборатории (по согласованию с заказчиком);
- Поставка специализированных компонентов военного и аэрокосмического уровня качества (Xilinx, Altera, Analog Devices, Intersil, Interpoint, Microsemi, Actel, Aeroflex, Peregrine, VPT, Syfer, Eurofarad, Texas Instruments, MS Kennedy, Miteq, Cobham, E2V, MA-COM, Hittite, Mini-Circuits, General Dynamics и др.);

Компания «Океан Электроники» является официальным дистрибьютором и эксклюзивным представителем в России одного из крупнейших производителей разъемов военного и аэрокосмического назначения «JONHON», а так же официальным дистрибьютором и эксклюзивным представителем в России производителя высокотехнологичных и надежных решений для передачи СВЧ сигналов «FORSTAR».



## JONHON

«JONHON» (основан в 1970 г.)

Разъемы специального, военного и аэрокосмического назначения:

(Применяются в военной, авиационной, аэрокосмической, морской, железнодорожной, горно- и нефтедобывающей отраслях промышленности)

«FORSTAR» (основан в 1998 г.)

ВЧ соединители, коаксиальные кабели, кабельные сборки и микроволновые компоненты:

(Применяются в телекоммуникациях гражданского и специального назначения, в средствах связи, РЛС, а так же военной, авиационной и аэрокосмической отраслях промышленности).



Телефон: 8 (812) 309-75-97 (многоканальный)

Факс: 8 (812) 320-03-32

Электронная почта: [ocean@oceanchips.ru](mailto:ocean@oceanchips.ru)

Web: <http://oceanchips.ru/>

Адрес: 198099, г. Санкт-Петербург, ул. Калинина, д. 2, корп. 4, лит. А