

## 2K 5.0V I<sup>2</sup>C™ Serial EEPROM

### Features:

- Single-Supply with Operation from 4.5V to 5.5V
- Low-Power CMOS Technology:
  - Read current 1 mA, max.
  - Standby current 5  $\mu$ A, max.
- 2-Wire Serial Interface, I<sup>2</sup>C™ Compatible
- Cascadable up to Eight Devices
- Schmitt Trigger Inputs for Noise Suppression
- Output Slope Control to Eliminate Ground Bounce
- 100 kHz and 400 kHz Clock Compatibility
- Fast Page or Byte Write Time 1 ms, typical
- Self-Timed Erase/Write Cycle
- 16-Byte Page Write Buffer
- Hardware Write-Protect for Upper Half of the Array (80h-FFh)
- ESD Protection >4,000V
- More than 1 Million Erase/Write Cycles
- Data Retention >200 Years
- Factory Programming Available
- Packages Include 8-lead PDIP, SOIC, TSSOP, DFN, TDFN and MSOP
- Pb-Free and RoHS Compliant
- Temperature ranges:
  - Industrial (I):       -40°C to +85°C
  - Automotive (E):     -40°C to +125°C

### Description:

The Microchip Technology Inc. 24C02C is a 2K bit Serial Electrically Erasable PROM with a voltage range of 4.5V to 5.5V. The device is organized as a single block of 256 x 8-bit memory with a 2-wire serial interface. Low-current design permits operation with max. standby and active currents of only 5  $\mu$ A and 1 mA, respectively. The device has a page write capability for up to 16 bytes of data and has fast write cycle times of only 1 ms for both byte and page writes. Functional address lines allow the connection of up to eight 24C02C devices on the same bus for up to 16K bits of contiguous EEPROM memory. The device is available in the standard 8-pin PDIP, 8-pin SOIC (3.90 mm), 8-pin 2x3 DFN and TDFN, 8-pin MSOP and TSSOP packages.

### Block Diagram



### Package Types



# 24C02C

## 1.0 ELECTRICAL CHARACTERISTICS

### Absolute Maximum Ratings<sup>(†)</sup>

|   |                                |
|---|--------------------------------|
| V <sub>CC</sub> .....                               | 7.0V                           |
| All inputs and outputs w.r.t. V <sub>SS</sub> ..... | -0.6V to V <sub>CC</sub> +1.0V |
| Storage temperature .....                           | -65°C to +150°C                |
| Ambient temperature with power applied.....         | -40°C to +125°C                |
| ESD protection on all pins .....                    | ≥ 4 kV                         |

† NOTICE: Stresses above those listed under “Absolute Maximum Ratings” may cause permanent damage to the device. This is a stress rating only and functional operation of the device at these or any other conditions above those indicated in the operational listings of this specification is not implied. Exposure to Absolute Maximum Rating conditions for extended periods may affect device reliability.

**TABLE 1-1: DC CHARACTERISTICS**

| DC CHARACTERISTICS |                                    |  | Electrical Characteristics:                     |                     |                                  |   |
|--------------------|------------------------------------|--|---|---------------------|----------------------------------|---|
|                    |                                    |  | Industrial (I): V <sub>CC</sub> = +4.5V to 5.5V |                     | T <sub>A</sub> = -40°C to +85°C  |   |
|                    |                                    |  | Automotive (E): V <sub>CC</sub> = +4.5V to 5.5V |                     | T <sub>A</sub> = -40°C to +125°C |   |
| Param. No.         | Sym.                               | Characteristic                                       | Min.  | Max.                | Units                            | Conditions  |
| D1                 | —                                  | A0, A1, A2, SCL, SDA and WP pins:                    | —   | —                   | —                                | —   |
| D2                 | V <sub>IH</sub>                    | High-level input voltage                             | 0.7 V <sub>CC</sub>                             | —                   | V                                | —   |
| D3                 | V <sub>IL</sub>                    | Low-level input voltage                              | —   | 0.3 V <sub>CC</sub> | V                                | —   |
| D4                 | V <sub>HYS</sub>                   | Hysteresis of Schmitt Trigger inputs (SDA, SCL pins) | 0.05 V <sub>CC</sub>                            | —                   | V                                | <b>(Note)</b>   |
| D5                 | V <sub>OL</sub>                    | Low-level output voltage                             | —   | 0.40                | V                                | I <sub>OL</sub> = 3.0 ma @ V <sub>CC</sub> = 4.5V                           |
| D6                 | I <sub>LI</sub>                    | Input leakage current                                | —   | ±1                  | μA                               | V <sub>IN</sub> = V <sub>SS</sub> or V <sub>CC</sub> , WP = V <sub>SS</sub> |
| D7                 | I <sub>LO</sub>                    | Output leakage current                               | —   | ±1                  | μA                               | V <sub>OUT</sub> = V <sub>SS</sub> or V <sub>CC</sub>                       |
| D8                 | C <sub>IN</sub> , C <sub>OUT</sub> | Pin capacitance (all inputs/outputs)                 | —   | 10                  | pF                               | V <sub>CC</sub> = 5.0V <b>(Note)</b><br>T <sub>A</sub> = 25°C, f = 1 MHz    |
| D9                 | I <sub>CC</sub> Read               | Operating current                                    | —   | 1                   | mA                               | V <sub>CC</sub> = 5.5V, SCL = 400 kHz                                       |
|                    | I <sub>CC</sub> Write              |  | —   | 3                   | mA                               | V <sub>CC</sub> = 5.5V  |
| D10                | I <sub>CCS</sub>                   | Standby current                                      | —   | 5                   | μA                               | V <sub>CC</sub> = 5.5V SCL = SDA = V <sub>CC</sub><br>WP = V <sub>SS</sub>  |

**Note:** This parameter is periodically sampled and not 100% tested.

TABLE 1-2: AC CHARACTERISTICS

| AC CHARACTERISTICS |         |  | Electrical Characteristics:         |             |                      |                      |
|--------------------|---------|--|-------------------------------------|-------------|----------------------|----------------------|
|                    |         |  | Industrial (I): VCC = +4.5V to 5.5V |             | TA = -40°C to +85°C  |                      |
|                    |         |  | Automotive (E): VCC = +4.5V to 5.5V |             | TA = -40°C to +125°C |                      |
| Param. No.         | Sym.    | Characteristic   | Min.                                | Max.        | Units                | Conditions           |
| 1                  | FCLK    | Clock frequency  | —<br>—                              | 100<br>400  | kHz                  | —<br>(I-temp)        |
| 2                  | THIGH   | Clock high time  | 4000<br>600                         | —<br>—      | ns                   | —<br>(I-temp)        |
| 3                  | TLOW    | Clock low time   | 4700<br>1300                        | —<br>—      | ns                   | —<br>(I-temp)        |
| 4                  | TR      | SDA and SCL rise time<br><b>(Note 1)</b>                                     | —<br>—                              | 1000<br>300 | ns                   | —<br>(I-temp)        |
| 5                  | TF      | SDA and SCL fall time<br><b>(Note 1)</b>                                     | —                                   | 300         | ns                   | —<br>(I-temp)        |
| 6                  | THD:STA | Start condition hold time  | 4000<br>600                         | —<br>—      | ns                   | —<br>(I-temp)        |
| 7                  | TSU:STA | Start condition setup time   | 4700<br>600                         | —<br>—      | ns                   | —<br>(I-temp)        |
| 8                  | THD:DAT | Data input hold time   | 0                                   | —           | ns                   | <b>(Note 2)</b>      |
| 9                  | TSU:DAT | Data input setup time  | 250<br>100                          | —<br>—      | ns                   | —<br>(I-temp)        |
| 10                 | TSU:STO | Stop condition setup time  | 4000<br>600                         | —<br>—      | ns                   | —<br>(I-temp)        |
| 11                 | TAA     | Output valid from clock<br><b>(Note 2)</b>                                   | —<br>—                              | 3500<br>900 | ns                   | —<br>(I-temp)        |
| 12                 | TBUF    | Bus free time: Time the bus must be free before a new transmission can start | 4700<br>1300                        | —<br>—      | ns                   | —<br>(I-temp)        |
| 13                 | TOF     | Output fall time from VIH minimum to VIL maximum<br>CB ≤ 100 pF              | 10 + 0.1CB                          | 250         | ns                   | <b>(Note 1)</b>      |
| 14                 | TSP     | Input filter spike suppression (SDA and SCL pins)                            | —                                   | 50          | ns                   | <b>(Note 3)</b>      |
| 15                 | TWC     | Write cycle time (byte or page)  | —                                   | 1.5<br>1    | ms                   | —<br>(I-temp)        |
| 16                 | —       | Endurance  | 1,000,000                           | —           | cycles               | 25°C <b>(Note 4)</b> |

**Note 1:** Not 100% tested. CB = total capacitance of one bus line in pF.

- 2:** As a transmitter, the device must provide an internal minimum delay time to bridge the undefined region (minimum 300 ns) of the falling edge of SCL to avoid unintended generation of Start or Stop conditions.
- 3:** The combined TSP and VHYS specifications are due to new Schmitt Trigger inputs, which provide improved noise spike suppression. This eliminates the need for a TI specification for standard operation.
- 4:** This parameter is not tested but ensured by characterization. For endurance estimates in a specific application, please consult the Total Endurance™ Model, which can be obtained from Microchip's web site at [www.microchip.com](http://www.microchip.com).

# 24C02C

FIGURE 1-1: BUS TIMING DATA



## 2.0 PIN DESCRIPTIONS

The descriptions of the pins are listed in Table 2-1.

**TABLE 2-1: PIN FUNCTION TABLE**

| Name | PDIP | SOIC | TSSOP | DFN/TDFN | MSOP | Function                     |
|------|------|------|-------|----------|------|------------------------------|
| A0   | 1    | 1    | 1     | 1        | 1    | Address Pin A0               |
| A1   | 2    | 2    | 2     | 2        | 2    | Address Pin A1               |
| A2   | 3    | 3    | 3     | 3        | 3    | Address Pin A2               |
| Vss  | 4    | 4    | 4     | 4        | 4    | Ground                       |
| SDA  | 5    | 5    | 5     | 5        | 5    | Serial Address/Data I/O      |
| SCL  | 6    | 6    | 6     | 6        | 6    | Serial Clock                 |
| WP   | 7    | 7    | 7     | 7        | 7    | Write-Protect Input          |
| Vcc  | 8    | 8    | 8     | 8        | 8    | +4.5 V to 5.5 V Power Supply |

### 2.1 SDA Serial Data

This is a bidirectional pin used to transfer addresses and data into and data out of the device. It is an open drain terminal; therefore, the SDA bus requires a pull-up resistor to Vcc (typical 10 k $\Omega$  for 100 kHz, 2 k $\Omega$  for 400 kHz).

For normal data transfer SDA is allowed to change only during SCL low. Changes during SCL high are reserved for indicating the Start and Stop conditions.

### 2.2 SCL Serial Clock

This input is used to synchronize the data transfer from and to the device.

### 2.3 A0, A1, A2

The levels on these inputs are compared with the corresponding bits in the slave address. The chip is selected if the compare is true.

Up to eight 24C02C devices may be connected to the same bus by using different Chip Select bit combinations. These inputs must be connected to either Vcc or Vss.

### 2.4 WP

This is the hardware write-protect pin. It must be tied to Vcc or Vss. If tied to Vcc, the hardware write protection is enabled. If the WP pin is tied to Vss the hardware write protection is disabled.

### 2.5 Noise Protection

The 24C02C employs a Vcc threshold detector circuit which disables the internal erase/write logic if the Vcc is below 3.8 volts at nominal conditions.

The SCL and SDA inputs have Schmitt Trigger and filter circuits which suppress noise spikes to assure proper device operation even on a noisy bus.

## 3.0 FUNCTIONAL DESCRIPTIONS

The 24C02C supports a bidirectional 2-wire bus and data transmission protocol. A device that sends data onto the bus is defined as transmitter, and a device receiving data as receiver. The bus has to be controlled by a master device that generates the Serial Clock (SCL), controls the bus access, and generates the Start and Stop conditions, while the 24C02C works as slave. Both master and slave can operate as transmitter or receiver but the master device determines which mode is activated.

## 4.0 BUS CHARACTERISTICS

The following **bus protocol** has been defined:

- Data transfer may be initiated only when the bus is not busy.
- During data transfer, the data line must remain stable whenever the clock line is high. Changes in the data line while the clock line is high will be interpreted as a Start or Stop condition.

Accordingly, the following bus conditions have been defined (Figure 4-1).

### 4.1 Bus Not Busy (A)

Both data and clock lines remain high.

### 4.2 Start Data Transfer (B)

A high-to-low transition of the SDA line while the clock (SCL) is high determines a Start condition. All commands must be preceded by a Start condition.

### 4.3 Stop Data Transfer (C)

A low-to-high transition of the SDA line while the clock (SCL) is high determines a Stop condition. All operations must be ended with a Stop condition.

## 4.4 Data Valid (D)

The state of the data line represents valid data when, after a Start condition, the data line is stable for the duration of the high period of the clock signal.

The data on the line must be changed during the low period of the clock signal. There is one bit of data per clock pulse.

Each data transfer is initiated with a Start condition and terminated with a Stop condition. The number of the data bytes transferred between the Start and Stop conditions is determined by the master device and is theoretically unlimited, although only the last sixteen will be stored when doing a write operation. When an overwrite does occur it will replace data in a first-in first-out fashion.

## 4.5 Acknowledge

Each receiving device, when addressed, is required to generate an acknowledge after the reception of each byte. The master device must generate an extra clock pulse, which is associated with this Acknowledge bit.

|   |
|---|
| <b>Note:</b> The 24C02C does not generate any Acknowledge bits if an internal programming cycle is in progress. |
|---|

The device that acknowledges has to pull down the SDA line during the Acknowledge clock pulse in such a way that the SDA line is stable low during the high period of the acknowledge related clock pulse. Of course, setup and hold times must be taken into account. A master must signal an end of data to the slave by not generating an Acknowledge bit on the last byte that has been clocked out of the slave. In this case, the slave must leave the data line high to enable the master to generate the Stop condition (Figure 4-2).

**FIGURE 4-1: DATA TRANSFER SEQUENCE ON THE SERIAL BUS**

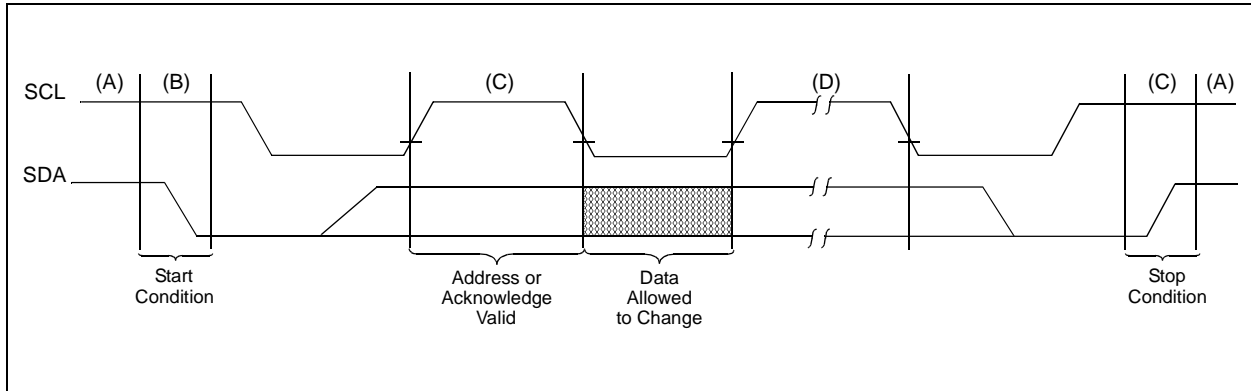

**FIGURE 4-2: ACKNOWLEDGE TIMING**

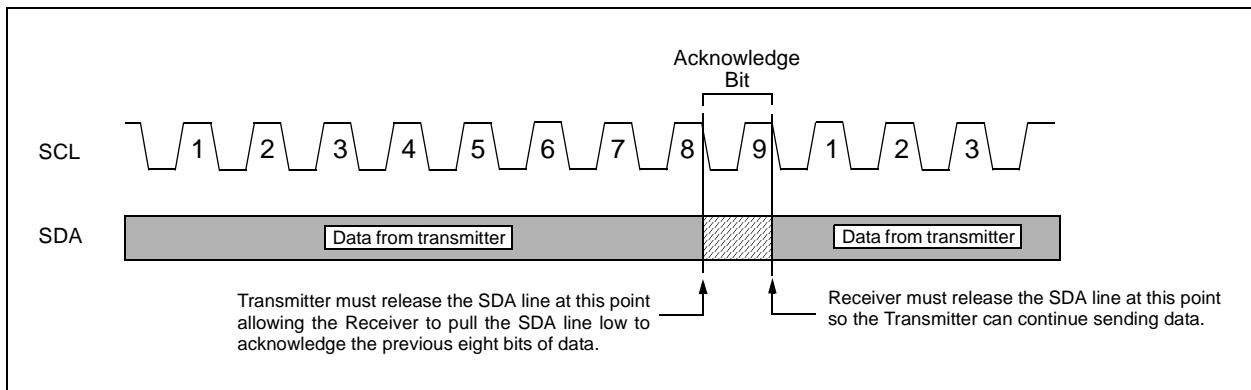

## 5.0 DEVICE ADDRESSING

A control byte is the first byte received following the Start condition from the master device (Figure 5-1). The control byte consists of a four-bit control code; for the 24C02C this is set as '1010' binary for read and write operations. The next three bits of the control byte are the Chip Select bits (A2, A1, A0). The Chip Select bits allow the use of up to eight 24C02C devices on the same bus and are used to select which device is accessed. The Chip Select bits in the control byte must correspond to the logic levels on the corresponding A2, A1 and A0 pins for the device to respond. These bits are in effect the three Most Significant bits of the word address.

The last bit of the control byte defines the operation to be performed. When set to a '1' a read operation is selected, and when set to a '0' a write operation is selected. Following the Start condition, the 24C02C monitors the SDA bus checking the control byte being transmitted. Upon receiving a '1010' code and appropriate Chip Select bits, the slave device outputs an Acknowledge signal on the SDA line. Depending on the state of the R/W bit, the 24C02C will select a read or write operation.

FIGURE 5-1: CONTROL BYTE FORMAT

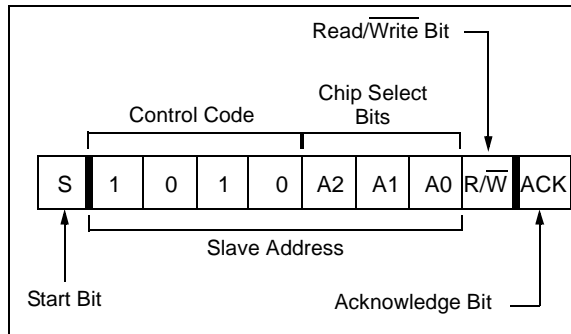

## 5.1 Contiguous Addressing Across Multiple Devices

The Chip Select bits A2, A1, A0 can be used to expand the contiguous address space for up to 16K bits by adding up to eight 24C02C devices on the same bus. In this case, software can use A0 of the **control byte** as address bit A9, A1 as address bit A10, and A2 as address bit A11. It is not possible to write or read across device boundaries.



## 6.0 WRITE OPERATIONS

### 6.1 Byte Write

Following the Start signal from the master, the device code (4 bits), the Chip Select bits (3 bits) and the R/W bit, which is a logic low, is placed onto the bus by the master transmitter. The device will acknowledge this control byte during the ninth clock pulse. The next byte transmitted by the master is the word address and will be written into the Address Pointer of the 24C02C. After receiving another Acknowledge signal from the 24C02C the master device will transmit the data word to be written into the addressed memory location. The 24C02C acknowledges again and the master generates a Stop condition. This initiates the internal write cycle, and during this time the 24C02C will not generate Acknowledge signals (Figure 6-1). If an attempt is made to write to the protected portion of the array when the hardware write protection has been enabled, the device will acknowledge the command but no data will be written. The write cycle time must be observed even if the write protection is enabled.

### 6.2 Page Write

The write control byte, word address and the first data byte are transmitted to the 24C02C in the same way as in a byte write. But instead of generating a Stop condition, the master transmits up to 15 additional data bytes to the 24C02C which are temporarily stored in the on-chip page buffer and will be written into the memory after the master has transmitted a Stop condition. After the receipt of each word, the four lower order Address Pointer bits are internally incremented by one. The higher order four bits of the word address remains constant. If the master should transmit more than 16 bytes prior to generating the Stop condition, the address counter will roll over and the previously received data will be overwritten.

As with the byte write operation, once the Stop condition is received an internal write cycle will begin (Figure 6-2). If an attempt is made to write to the protected portion of the array when the hardware write protection has been enabled, the device will acknowledge the command, but no data will be written. The write cycle time must be observed even if the write protection is enabled.

**Note:** Page write operations are limited to writing bytes within a single physical page, **regardless** of the number of bytes actually being written. Physical page boundaries start at addresses that are integer multiples of the page buffer size (or 'page size') and end at addresses that are integer multiples of [page size - 1]. If a Page Write command attempts to write across a physical page boundary, the result is that the data wraps around to the beginning of the current page (overwriting data previously stored there), instead of being written to the next page as might be expected. It is therefore necessary for the application software to prevent page write operations that would attempt to cross a page boundary.

### 6.3 Write Protection

The WP pin must be tied to VCC or VSS. If tied to VCC, the upper half of the array (080-0FF) will be write-protected. If the WP pin is tied to VSS, then write operations to all address locations are allowed.

**FIGURE 6-1: BYTE WRITE**

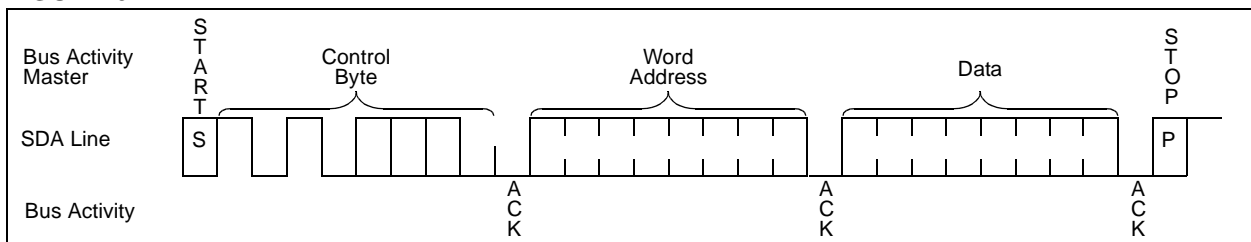

**FIGURE 6-2: PAGE WRITE**

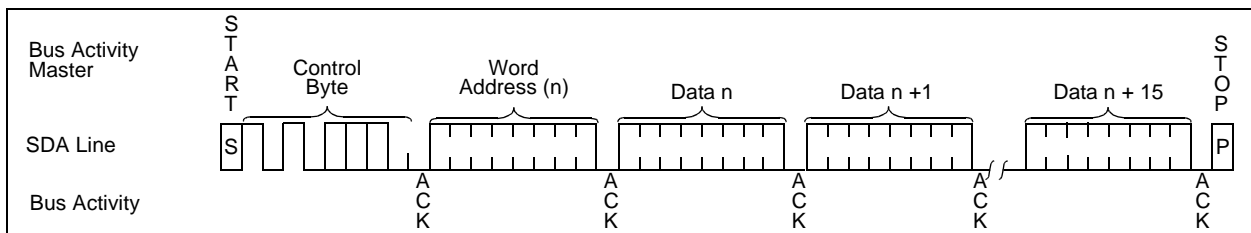

## 7.0 ACKNOWLEDGE POLLING

Since the device will not acknowledge during a write cycle, this can be used to determine when the cycle is complete (this feature can be used to maximize bus throughput). Once the Stop condition for a Write command has been issued from the master, the device initiates the internally timed write cycle. ACK polling can be initiated immediately. This involves the master sending a Start condition followed by the control byte for a Write command ( $R/\overline{W} = 0$ ). If the device is still busy with the write cycle, then no ACK will be returned. If no ACK is returned, then the Start bit and control byte must be re-sent. If the cycle is complete, then the device will return the ACK and the master can then proceed with the next Read or Write command. See Figure 7-1 for flow diagram.

FIGURE 7-1: ACKNOWLEDGE POLLING FLOW



## 8.0 READ OPERATION

Read operations are initiated in the same way as write operations with the exception that the R/W bit of the slave address is set to one. There are three basic types of read operations: current address read, random read, and sequential read.

### 8.1 Current Address Read

The 24C02C contains an address counter that maintains the address of the last word accessed, internally incremented by one. Therefore, if the previous read access was to address n, the next current address read operation would access data from address n + 1. Upon receipt of the slave address with the R/W bit set to one, the 24C02C issues an acknowledge and transmits the eight bit data word. The master will not acknowledge the transfer, but does generate a Stop condition and the 24C02C discontinues transmission (Figure 8-1).

**FIGURE 8-1: CURRENT ADDRESS READ**



### 8.2 Random Read

Random read operations allow the master to access any memory location in a random manner. To perform this type of read operation, first the word address must be set. This is done by sending the word address to the 24C02C as part of a write operation. After the word address is sent, the master generates a Start condition following the acknowledge. This terminates the write operation, but not before the internal Address Pointer is set. Then the master issues the control byte again but with the R/W bit set to a one. The 24C02C will then issue an acknowledge and transmits the eight bit data word. The master will not acknowledge the transfer but does generate a Stop condition and the 24C02C discontinues transmission (Figure 8-2). After this command, the internal address counter will point to the address location following the one that was just read.

### 8.3 Sequential Read

Sequential reads are initiated in the same way as a random read except that after the 24C02C transmits the first data byte, the master issues an acknowledge as opposed to a Stop condition in a random read. This directs the 24C02C to transmit the next sequentially addressed 8-bit word (Figure 8-3).

To provide sequential reads, the 24C02C contains an internal Address Pointer which is incremented by one at the completion of each operation. This Address Pointer allows the entire memory contents to be serially read during one operation. The internal Address Pointer will automatically roll over from address FF to address 00.

**FIGURE 8-2: RANDOM READ**



**FIGURE 8-3: SEQUENTIAL READ**



# 24C02C

## 9.0 PACKAGING INFORMATION

### 9.1 Package Marking Information

8-Lead PDIP (300 mil)



Example:



8-Lead SOIC (3.90 mm)

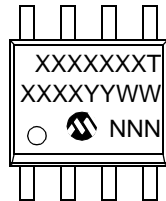

Example:

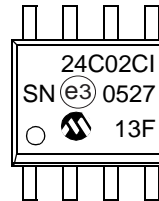

8-Lead TSSOP



Example:

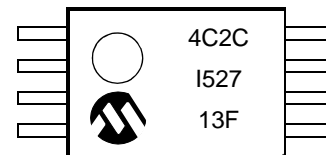

8-Lead MSOP

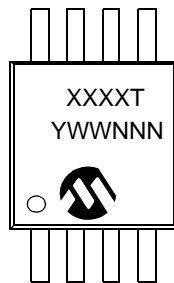

Example:



8-Lead 2x3 DFN

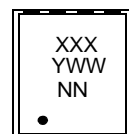

Example:

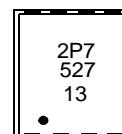

8-Lead 2x3 TDFN

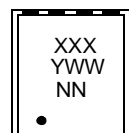

Example:

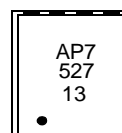

| Part Number | 1st Line Marking Codes |       |         |         |         |         |
|-------------|------------------------|-------|---------|---------|---------|---------|
|             | TSSOP                  | MSOP  | DFN     |         | TDFN    |         |
|             |                        |       | I Temp. | E Temp. | I Temp. | E Temp. |
| 24C02C      | 4C2C                   | 4C2CT | 2P7     | 2P8     | AP7     | AP8     |

**Note:** T = Temperature grade (I, E)

|  |
|--|
| <p><b>Legend:</b> XX...X Part number or part number code<br/> T Temperature (I, E)<br/> Y Year code (last digit of calendar year)<br/> YY Year code (last 2 digits of calendar year)<br/> WW Week code (week of January 1 is week '01')<br/> NNN Alphanumeric traceability code (2 characters for small packages)<br/> ⓔ Pb-free JEDEC designator for Matte Tin (Sn)</p>                 |
| <p><b>Note:</b> For very small packages with no room for the Pb-free JEDEC designator ⓔ, the marking will only appear on the outer carton or reel label.</p> <p><b>Note:</b> In the event the full Microchip part number cannot be marked on one line, it will be carried over to the next line, thus limiting the number of available characters for customer-specific information.</p> |

**Note:** Please visit [www.microchip.com/Pbfree](http://www.microchip.com/Pbfree) for the latest information on Pb-free conversion.

\*Standard OTP marking consists of Microchip part number, year code, week code, and traceability code.

# 24C02C

## 8-Lead Plastic Dual In-Line (P) – 300 mil Body [PDIP]

**Note:** For the most current package drawings, please see the Microchip Packaging Specification located at <http://www.microchip.com/packaging>

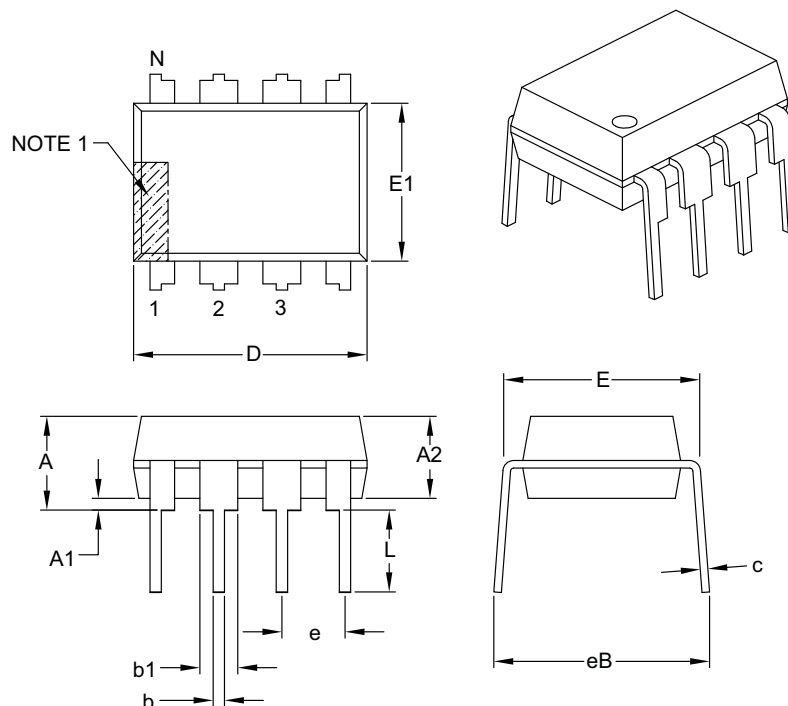

| Dimension Limits           | Units | INCHES   |      |      |
|----------------------------|-------|----------|------|------|
|                            |       | MIN      | NOM  | MAX  |
| Number of Pins             | N     | 8        |      |      |
| Pitch                      | e     | .100 BSC |      |      |
| Top to Seating Plane       | A     | –        | –    | .210 |
| Molded Package Thickness   | A2    | .115     | .130 | .195 |
| Base to Seating Plane      | A1    | .015     | –    | –    |
| Shoulder to Shoulder Width | E     | .290     | .310 | .325 |
| Molded Package Width       | E1    | .240     | .250 | .280 |
| Overall Length             | D     | .348     | .365 | .400 |
| Tip to Seating Plane       | L     | .115     | .130 | .150 |
| Lead Thickness             | c     | .008     | .010 | .015 |
| Upper Lead Width           | b1    | .040     | .060 | .070 |
| Lower Lead Width           | b     | .014     | .018 | .022 |
| Overall Row Spacing §      | eB    | –        | –    | .430 |

**Notes:**

- Pin 1 visual index feature may vary, but must be located with the hatched area.
- § Significant Characteristic.
- Dimensions D and E1 do not include mold flash or protrusions. Mold flash or protrusions shall not exceed .010" per side.
- Dimensioning and tolerancing per ASME Y14.5M.

BSC: Basic Dimension. Theoretically exact value shown without tolerances.

Microchip Technology Drawing C04-018B

## 8-Lead Plastic Small Outline (SN) – Narrow, 3.90 mm Body [SOIC]

**Note:** For the most current package drawings, please see the Microchip Packaging Specification located at <http://www.microchip.com/packaging>



| Dimension Limits         | Units | MILLIMETERS |     |      |
|--------------------------|-------|-------------|-----|------|
|                          |       | MIN         | NOM | MAX  |
| Number of Pins           | N     | 8           |     |      |
| Pitch                    | e     | 1.27 BSC    |     |      |
| Overall Height           | A     | –           | –   | 1.75 |
| Molded Package Thickness | A2    | 1.25        | –   | –    |
| Standoff §               | A1    | 0.10        | –   | 0.25 |
| Overall Width            | E     | 6.00 BSC    |     |      |
| Molded Package Width     | E1    | 3.90 BSC    |     |      |
| Overall Length           | D     | 4.90 BSC    |     |      |
| Chamfer (optional)       | h     | 0.25        | –   | 0.50 |
| Foot Length              | L     | 0.40        | –   | 1.27 |
| Footprint                | L1    | 1.04 REF    |     |      |
| Foot Angle               | φ     | 0°          | –   | 8°   |
| Lead Thickness           | c     | 0.17        | –   | 0.25 |
| Lead Width               | b     | 0.31        | –   | 0.51 |
| Mold Draft Angle Top     | α     | 5°          | –   | 15°  |
| Mold Draft Angle Bottom  | β     | 5°          | –   | 15°  |

**Notes:**

1. Pin 1 visual index feature may vary, but must be located within the hatched area.
2. § Significant Characteristic.
3. Dimensions D and E1 do not include mold flash or protrusions. Mold flash or protrusions shall not exceed 0.15 mm per side.
4. Dimensioning and tolerancing per ASME Y14.5M.

BSC: Basic Dimension. Theoretically exact value shown without tolerances.

REF: Reference Dimension, usually without tolerance, for information purposes only.

Microchip Technology Drawing C04-057B

# 24C02C

## 8-Lead Plastic Small Outline (SN) – Narrow, 3.90 mm Body [SOIC]

**Note:** For the most current package drawings, please see the Microchip Packaging Specification located at <http://www.microchip.com/packaging>

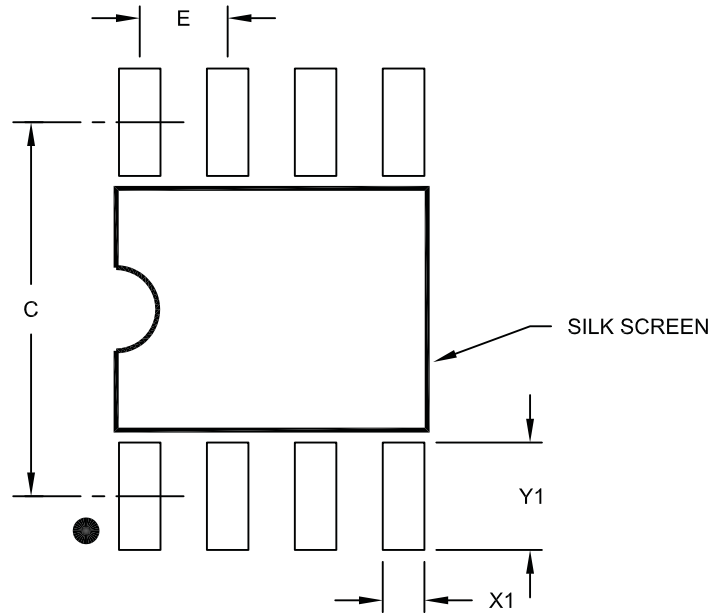

RECOMMENDED LAND PATTERN

| Dimension Limits        | Units | MILLIMETERS |      |      |
|-------------------------|-------|-------------|------|------|
|                         |       | MIN         | NOM  | MAX  |
| Contact Pitch           | E     | 1.27 BSC    |      |      |
| Contact Pad Spacing     | C     |             | 5.40 |      |
| Contact Pad Width (X8)  | X1    |             |      | 0.60 |
| Contact Pad Length (X8) | Y1    |             |      | 1.55 |

Notes:

1. Dimensioning and tolerancing per ASME Y14.5M

BSC: Basic Dimension. Theoretically exact value shown without tolerances.

Microchip Technology Drawing No. C04-2057A



## 8-Lead Plastic Thin Shrink Small Outline (ST) – 4.4 mm Body [TSSOP]

**Note:** For the most current package drawings, please see the Microchip Packaging Specification located at <http://www.microchip.com/packaging>



| Dimension Limits         | Units  | MILLIMETERS |      |      |
|--------------------------|--------|-------------|------|------|
|                          |        | MIN         | NOM  | MAX  |
| Number of Pins           | N      | 8           |      |      |
| Pitch                    | e      | 0.65 BSC    |      |      |
| Overall Height           | A      | –           | –    | 1.20 |
| Molded Package Thickness | A2     | 0.80        | 1.00 | 1.05 |
| Standoff                 | A1     | 0.05        | –    | 0.15 |
| Overall Width            | E      | 6.40 BSC    |      |      |
| Molded Package Width     | E1     | 4.30        | 4.40 | 4.50 |
| Molded Package Length    | D      | 2.90        | 3.00 | 3.10 |
| Foot Length              | L      | 0.45        | 0.60 | 0.75 |
| Footprint                | L1     | 1.00 REF    |      |      |
| Foot Angle               | $\phi$ | 0°          | –    | 8°   |
| Lead Thickness           | c      | 0.09        | –    | 0.20 |
| Lead Width               | b      | 0.19        | –    | 0.30 |

**Notes:**

- Pin 1 visual index feature may vary, but must be located within the hatched area.
- Dimensions D and E1 do not include mold flash or protrusions. Mold flash or protrusions shall not exceed 0.15 mm per side.
- Dimensioning and tolerancing per ASME Y14.5M.

BSC: Basic Dimension. Theoretically exact value shown without tolerances.

REF: Reference Dimension, usually without tolerance, for information purposes only.

Microchip Technology Drawing C04-086B

# 24C02C

## 8-Lead Plastic Micro Small Outline Package (MS) [MSOP]

**Note:** For the most current package drawings, please see the Microchip Packaging Specification located at <http://www.microchip.com/packaging>



| Dimension Limits         | Units  | MILLIMETERS |      |      |
|--------------------------|--------|-------------|------|------|
|                          |        | MIN         | NOM  | MAX  |
| Number of Pins           | N      | 8           |      |      |
| Pitch                    | e      | 0.65 BSC    |      |      |
| Overall Height           | A      | –           | –    | 1.10 |
| Molded Package Thickness | A2     | 0.75        | 0.85 | 0.95 |
| Standoff                 | A1     | 0.00        | –    | 0.15 |
| Overall Width            | E      | 4.90 BSC    |      |      |
| Molded Package Width     | E1     | 3.00 BSC    |      |      |
| Overall Length           | D      | 3.00 BSC    |      |      |
| Foot Length              | L      | 0.40        | 0.60 | 0.80 |
| Footprint                | L1     | 0.95 REF    |      |      |
| Foot Angle               | $\phi$ | 0°          | –    | 8°   |
| Lead Thickness           | c      | 0.08        | –    | 0.23 |
| Lead Width               | b      | 0.22        | –    | 0.40 |

### Notes:

- Pin 1 visual index feature may vary, but must be located within the hatched area.
- Dimensions D and E1 do not include mold flash or protrusions. Mold flash or protrusions shall not exceed 0.15 mm per side.
- Dimensioning and tolerancing per ASME Y14.5M.

BSC: Basic Dimension. Theoretically exact value shown without tolerances.

REF: Reference Dimension, usually without tolerance, for information purposes only.

Microchip Technology Drawing C04-111B

## 8-Lead Plastic Dual Flat, No Lead Package (MC) – 2x3x0.9 mm Body [DFN]

**Note:** For the most current package drawings, please see the Microchip Packaging Specification located at <http://www.microchip.com/packaging>

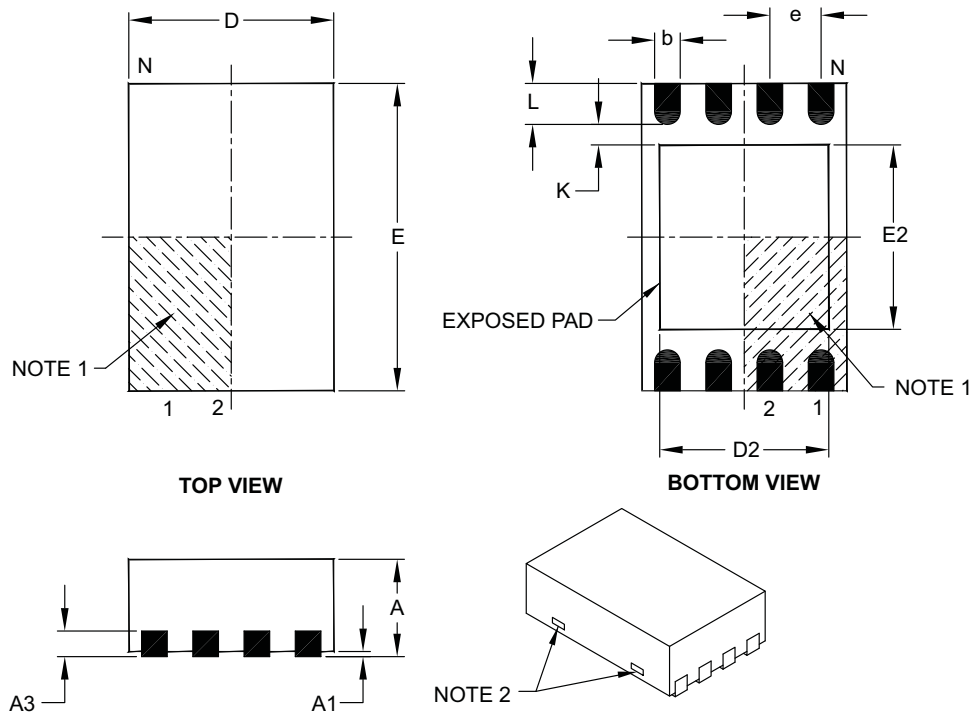

| Dimension Limits       | Units | MILLIMETERS |      |      |
|------------------------|-------|-------------|------|------|
|                        |       | MIN         | NOM  | MAX  |
| Number of Pins         | N     | 8           |      |      |
| Pitch                  | e     | 0.50 BSC    |      |      |
| Overall Height         | A     | 0.80        | 0.90 | 1.00 |
| Standoff               | A1    | 0.00        | 0.02 | 0.05 |
| Contact Thickness      | A3    | 0.20 REF    |      |      |
| Overall Length         | D     | 2.00 BSC    |      |      |
| Overall Width          | E     | 3.00 BSC    |      |      |
| Exposed Pad Length     | D2    | 1.30        | –    | 1.55 |
| Exposed Pad Width      | E2    | 1.50        | –    | 1.75 |
| Contact Width          | b     | 0.20        | 0.25 | 0.30 |
| Contact Length         | L     | 0.30        | 0.40 | 0.50 |
| Contact-to-Exposed Pad | K     | 0.20        | –    | –    |

**Notes:**

- Pin 1 visual index feature may vary, but must be located within the hatched area.
- Package may have one or more exposed tie bars at ends.
- Package is saw singulated.
- Dimensioning and tolerancing per ASME Y14.5M.

BSC: Basic Dimension. Theoretically exact value shown without tolerances.

REF: Reference Dimension, usually without tolerance, for information purposes only.

Microchip Technology Drawing C04-123C

# 24C02C

## 8-Lead Plastic Dual Flat, No Lead Package (MC) – 2x3x0.9 mm Body [DFN]

**Note:** For the most current package drawings, please see the Microchip Packaging Specification located at <http://www.microchip.com/packaging>



RECOMMENDED LAND PATTERN

| Dimension Limits           | Units | MILLIMETERS |      |      |
|----------------------------|-------|-------------|------|------|
|                            |       | MIN         | NOM  | MAX  |
| Contact Pitch              | E     | 0.50 BSC    |      |      |
| Optional Center Pad Width  | W2    |             |      | 1.45 |
| Optional Center Pad Length | T2    |             |      | 1.75 |
| Contact Pad Spacing        | C1    |             | 2.90 |      |
| Contact Pad Width (X8)     | X1    |             |      | 0.30 |
| Contact Pad Length (X8)    | Y1    |             |      | 0.75 |
| Distance Between Pads      | G     | 0.20        |      |      |

Notes:

1. Dimensioning and tolerancing per ASME Y14.5M

BSC: Basic Dimension. Theoretically exact value shown without tolerances.

Microchip Technology Drawing No. C04-2123A

## 8-Lead Plastic Dual Flat, No Lead Package (MN) – 2x3x0.75 mm Body [TDFN]

**Note:** For the most current package drawings, please see the Microchip Packaging Specification located at <http://www.microchip.com/packaging>

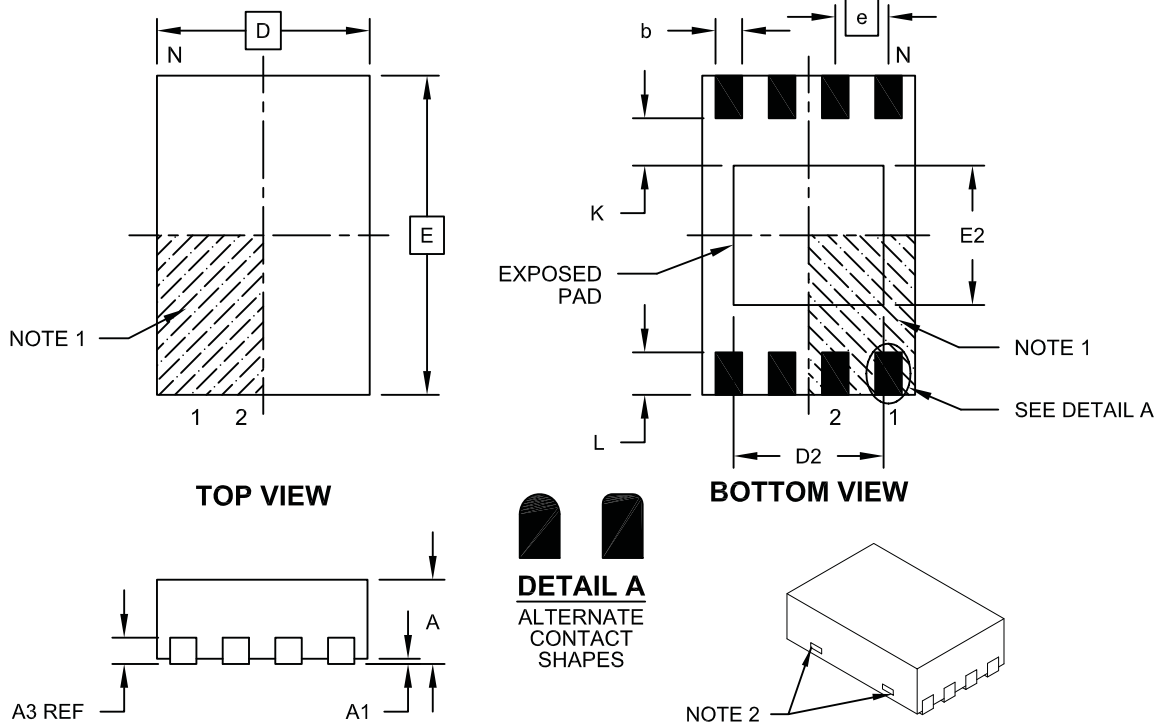

| Dimension              | Units | MILLIMETERS |      |      |
|------------------------|-------|-------------|------|------|
|                        |       | MIN         | NOM  | MAX  |
| Number of Pins         | N     | 8           |      |      |
| Pitch                  | e     | 0.50 BSC    |      |      |
| Overall Height         | A     | 0.70        | 0.75 | 0.80 |
| Standoff               | A1    | 0.00        | 0.02 | 0.05 |
| Contact Thickness      | A3    | 0.20 REF    |      |      |
| Overall Length         | D     | 2.00 BSC    |      |      |
| Overall Width          | E     | 3.00 BSC    |      |      |
| Exposed Pad Length     | D2    | 1.20        | -    | 1.60 |
| Exposed Pad Width      | E2    | 1.20        | -    | 1.60 |
| Contact Width          | b     | 0.20        | 0.25 | 0.30 |
| Contact Length         | L     | 0.25        | 0.30 | 0.45 |
| Contact-to-Exposed Pad | K     | 0.20        | -    | -    |

**Notes:**

- Pin 1 visual index feature may vary, but must be located within the hatched area.
- Package may have one or more exposed tie bars at ends.
- Package is saw singulated
- Dimensioning and tolerancing per ASME Y14.5M

BSC: Basic Dimension. Theoretically exact value shown without tolerances.

REF: Reference Dimension, usually without tolerance, for information purposes only.

Microchip Technology Drawing No. C04-129B

# 24C02C

## 8-Lead Plastic Dual Flat, No Lead Package (MN) – 2x3x0.75 mm Body [TDFN]

**Note:** For the most current package drawings, please see the Microchip Packaging Specification located at <http://www.microchip.com/packaging>

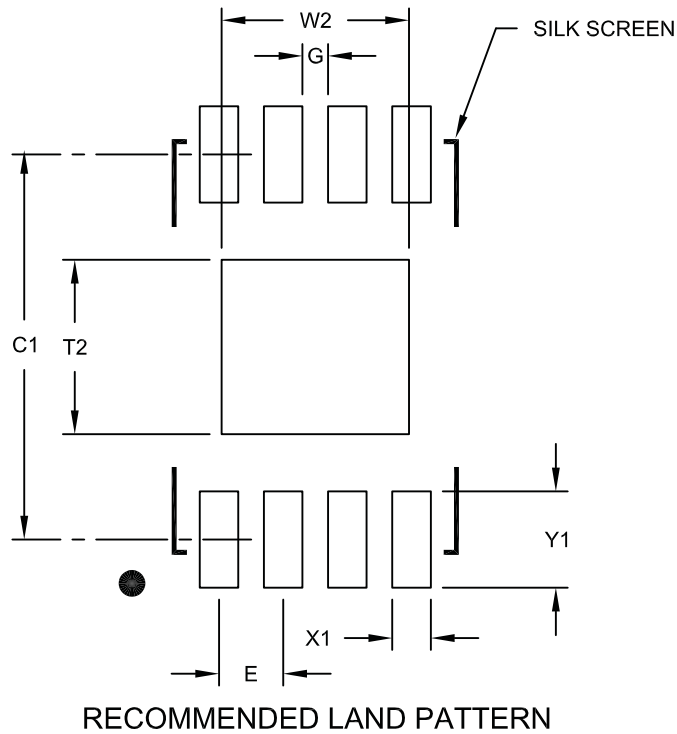

| Dimension Limits           | Units | MILLIMETERS |      |      |
|----------------------------|-------|-------------|------|------|
|                            |       | MIN         | NOM  | MAX  |
| Contact Pitch              | E     | 0.50 BSC    |      |      |
| Optional Center Pad Width  | W2    |             |      | 1.46 |
| Optional Center Pad Length | T2    |             |      | 1.36 |
| Contact Pad Spacing        | C1    |             | 3.00 |      |
| Contact Pad Width (X8)     | X1    |             |      | 0.30 |
| Contact Pad Length (X8)    | Y1    |             |      | 0.75 |
| Distance Between Pads      | G     | 0.20        |      |      |

**Notes:**

1. Dimensioning and tolerancing per ASME Y14.5M

BSC: Basic Dimension. Theoretically exact value shown without tolerances.

Microchip Technology Drawing No. C04-2129A

## **APPENDIX A: REVISION HISTORY**

### **Revision D**

Corrections to Section 1.0, Electrical Characteristics.

### **Revision E**

Added DFN package.

### **Revision F (02/2007)**

Revised Features section; Section 1.0 revised Ambient temperature; Revised Tables 1-1, 1-2, (removed commercial temp); Revised Table 2-1; Replaced On-line Support page; Replaced Package Drawings; Revised Product ID section.

### **Revision G (03/2007)**

Replaced Package Drawings (Rev. AM).

### **Revision H (04/2008)**

Replaced Package Drawings; Added TDFN package; Revised Product ID section.

### **Revision J (08/2008)**

Corrections to Table 1-1, DC Characteristics; Updated Table 1-2, AC Characteristics; Revised Figure 1-1; Updated Package Drawings.

# 24C02C

---

NOTES:



---

## THE MICROCHIP WEB SITE

Microchip provides online support via our WWW site at [www.microchip.com](http://www.microchip.com). This web site is used as a means to make files and information easily available to customers. Accessible by using your favorite Internet browser, the web site contains the following information:

- **Product Support** – Data sheets and errata, application notes and sample programs, design resources, user's guides and hardware support documents, latest software releases and archived software
- **General Technical Support** – Frequently Asked Questions (FAQ), technical support requests, online discussion groups, Microchip consultant program member listing
- **Business of Microchip** – Product selector and ordering guides, latest Microchip press releases, listing of seminars and events, listings of Microchip sales offices, distributors and factory representatives

## CUSTOMER CHANGE NOTIFICATION SERVICE

Microchip's customer notification service helps keep customers current on Microchip products. Subscribers will receive e-mail notification whenever there are changes, updates, revisions or errata related to a specified product family or development tool of interest.

To register, access the Microchip web site at [www.microchip.com](http://www.microchip.com), click on Customer Change Notification and follow the registration instructions.

## CUSTOMER SUPPORT

Users of Microchip products can receive assistance through several channels:

- Distributor or Representative
- Local Sales Office
- Field Application Engineer (FAE)
- Technical Support
- Development Systems Information Line

Customers should contact their distributor, representative or field application engineer (FAE) for support. Local sales offices are also available to help customers. A listing of sales offices and locations is included in the back of this document.

**Technical support is available through the web site at: <http://support.microchip.com>**

## READER RESPONSE

It is our intention to provide you with the best documentation possible to ensure successful use of your Microchip product. If you wish to provide your comments on organization, clarity, subject matter, and ways in which our documentation can better serve you, please FAX your comments to the Technical Publications Manager at (480) 792-4150.

Please list the following information, and use this outline to provide us with your comments about this document.

To: Technical Publications Manager  
RE: Reader Response  
Total Pages Sent \_\_\_\_\_

From: Name \_\_\_\_\_  
Company \_\_\_\_\_  
Address \_\_\_\_\_  
City / State / ZIP / Country \_\_\_\_\_  
Telephone: (\_\_\_\_\_) \_\_\_\_\_ - \_\_\_\_\_ FAX: (\_\_\_\_\_) \_\_\_\_\_ - \_\_\_\_\_

Application (optional):

Would you like a reply? \_\_\_Y \_\_\_N

Device: 24C02C

Literature Number: DS21202J

Questions:

1. What are the best features of this document?

---

---

2. How does this document meet your hardware and software development needs?

---

---

3. Do you find the organization of this document easy to follow? If not, why?

---

---

4. What additions to the document do you think would enhance the structure and subject?

---

---

5. What deletions from the document could be made without affecting the overall usefulness?

---

---

6. Is there any incorrect or misleading information (what and where)?

---

---

7. How would you improve this document?

---

---

## PRODUCT IDENTIFICATION SYSTEM

To order or obtain information, e.g., on pricing or delivery, refer to the factory or the listed sales office.

| <u>PART NO.</u>  | <u>X</u>          | <u>/XX</u>  |
|--|-------------------|---|
| Device   | Temperature Range | Package   |
| <p><b>Device:</b></p> <p>24C02C: 2K I<sup>2</sup>C™ Serial EEPROM<br/>           24C02CT: 2K I<sup>2</sup>C™ Serial EEPROM (Tape and Reel)</p> <p><b>Temperature Range:</b></p> <p>I = -40°C to +85°C<br/>           E = -40°C to +125°C</p> <p><b>Package:</b></p> <p>P = Plastic DIP (300 mil Body), 8-lead<br/>           SN = Plastic SOIC, (3.90 mm Body), 8-lead<br/>           ST = TSSOP (4.4 mm Body), 8-lead<br/>           MS = Plastic Micro Small Outline (MSOP), 8-lead<br/>           MC = Plastic Dual Flat (DFN), No lead package, 2x3 mm body, 8-lead<br/>           MNY<sup>(1)</sup> = Plastic Dual Flat (TDFN), No lead package, 2x3 mm body, 8-lead</p> <p><b>Note 1:</b> "Y" indicates a Nickel, Palladium, Gold (NiPdAu) finish.</p> |                   | <p><b>Examples:</b></p> <p>a) 24C02C-I/P: Industrial Temperature, PDIP Package</p> <p>b) 24C02C-E/SN: Extended Temperature, SOIC Package</p> <p>c) 24C02C-I/MNY: Industrial Temperature, 2x3 TDFN Package</p> |

# 24C02C

---

NOTES:

---

**Note the following details of the code protection feature on Microchip devices:**

- Microchip products meet the specification contained in their particular Microchip Data Sheet.
- Microchip believes that its family of products is one of the most secure families of its kind on the market today, when used in the intended manner and under normal conditions.
- There are dishonest and possibly illegal methods used to breach the code protection feature. All of these methods, to our knowledge, require using the Microchip products in a manner outside the operating specifications contained in Microchip's Data Sheets. Most likely, the person doing so is engaged in theft of intellectual property.
- Microchip is willing to work with the customer who is concerned about the integrity of their code.
- Neither Microchip nor any other semiconductor manufacturer can guarantee the security of their code. Code protection does not mean that we are guaranteeing the product as "unbreakable."

Code protection is constantly evolving. We at Microchip are committed to continuously improving the code protection features of our products. Attempts to break Microchip's code protection feature may be a violation of the Digital Millennium Copyright Act. If such acts allow unauthorized access to your software or other copyrighted work, you may have a right to sue for relief under that Act.

---

Information contained in this publication regarding device applications and the like is provided only for your convenience and may be superseded by updates. It is your responsibility to ensure that your application meets with your specifications. MICROCHIP MAKES NO REPRESENTATIONS OR WARRANTIES OF ANY KIND WHETHER EXPRESS OR IMPLIED, WRITTEN OR ORAL, STATUTORY OR OTHERWISE, RELATED TO THE INFORMATION, INCLUDING BUT NOT LIMITED TO ITS CONDITION, QUALITY, PERFORMANCE, MERCHANTABILITY OR FITNESS FOR PURPOSE. Microchip disclaims all liability arising from this information and its use. Use of Microchip devices in life support and/or safety applications is entirely at the buyer's risk, and the buyer agrees to defend, indemnify and hold harmless Microchip from any and all damages, claims, suits, or expenses resulting from such use. No licenses are conveyed, implicitly or otherwise, under any Microchip intellectual property rights.

**Trademarks**

The Microchip name and logo, the Microchip logo, Accuron, dsPIC, KEELOQ, KEELOQ logo, MPLAB, PIC, PICmicro, PICSTART, rfPIC and SmartShunt are registered trademarks of Microchip Technology Incorporated in the U.S.A. and other countries.

FilterLab, Linear Active Thermistor, MXDEV, MXLAB, SEEVAL, SmartSensor and The Embedded Control Solutions Company are registered trademarks of Microchip Technology Incorporated in the U.S.A.

Analog-for-the-Digital Age, Application Maestro, CodeGuard, dsPICDEM, dsPICDEM.net, dsPICworks, dsSPEAK, ECAN, ECONOMONITOR, FanSense, In-Circuit Serial Programming, ICSP, ICEPIC, Mindi, MiWi, MPASM, MPLAB Certified logo, MPLIB, MPLINK, mTouch, PICkit, PICDEM, PICDEM.net, PICtail, PIC<sup>32</sup> logo, PowerCal, PowerInfo, PowerMate, PowerTool, REAL ICE, rfLAB, Select Mode, Total Endurance, UNI/O, WiperLock and ZENA are trademarks of Microchip Technology Incorporated in the U.S.A. and other countries.

SQTP is a service mark of Microchip Technology Incorporated in the U.S.A.

All other trademarks mentioned herein are property of their respective companies.

© 2008, Microchip Technology Incorporated, Printed in the U.S.A., All Rights Reserved.

 Printed on recycled paper.

**QUALITY MANAGEMENT SYSTEM**  
**CERTIFIED BY DNV**  
**== ISO/TS 16949:2002 ==**

*Microchip received ISO/TS-16949:2002 certification for its worldwide headquarters, design and wafer fabrication facilities in Chandler and Tempe, Arizona; Gresham, Oregon and design centers in California and India. The Company's quality system processes and procedures are for its PIC® MCUs and dsPIC® DSCs, KEELOQ® code hopping devices, Serial EEPROMs, microperipherals, nonvolatile memory and analog products. In addition, Microchip's quality system for the design and manufacture of development systems is ISO 9001:2000 certified.*



---

---

## WORLDWIDE SALES AND SERVICE

---

---

### AMERICAS

**Corporate Office**  
2355 West Chandler Blvd.  
Chandler, AZ 85224-6199  
Tel: 480-792-7200  
Fax: 480-792-7277  
Technical Support:  
<http://support.microchip.com>  
Web Address:  
[www.microchip.com](http://www.microchip.com)

**Atlanta**  
Duluth, GA  
Tel: 678-957-9614  
Fax: 678-957-1455

**Boston**  
Westborough, MA  
Tel: 774-760-0087  
Fax: 774-760-0088

**Chicago**  
Itasca, IL  
Tel: 630-285-0071  
Fax: 630-285-0075

**Dallas**  
Addison, TX  
Tel: 972-818-7423  
Fax: 972-818-2924

**Detroit**  
Farmington Hills, MI  
Tel: 248-538-2250  
Fax: 248-538-2260

**Kokomo**  
Kokomo, IN  
Tel: 765-864-8360  
Fax: 765-864-8387

**Los Angeles**  
Mission Viejo, CA  
Tel: 949-462-9523  
Fax: 949-462-9608

**Santa Clara**  
Santa Clara, CA  
Tel: 408-961-6444  
Fax: 408-961-6445

**Toronto**  
Mississauga, Ontario,  
Canada  
Tel: 905-673-0699  
Fax: 905-673-6509

### ASIA/PACIFIC

**Asia Pacific Office**  
Suites 3707-14, 37th Floor  
Tower 6, The Gateway  
Harbour City, Kowloon  
Hong Kong  
Tel: 852-2401-1200  
Fax: 852-2401-3431

**Australia - Sydney**  
Tel: 61-2-9868-6733  
Fax: 61-2-9868-6755

**China - Beijing**  
Tel: 86-10-8528-2100  
Fax: 86-10-8528-2104

**China - Chengdu**  
Tel: 86-28-8665-5511  
Fax: 86-28-8665-7889

**China - Hong Kong SAR**  
Tel: 852-2401-1200  
Fax: 852-2401-3431

**China - Nanjing**  
Tel: 86-25-8473-2460  
Fax: 86-25-8473-2470

**China - Qingdao**  
Tel: 86-532-8502-7355  
Fax: 86-532-8502-7205

**China - Shanghai**  
Tel: 86-21-5407-5533  
Fax: 86-21-5407-5066

**China - Shenyang**  
Tel: 86-24-2334-2829  
Fax: 86-24-2334-2393

**China - Shenzhen**  
Tel: 86-755-8203-2660  
Fax: 86-755-8203-1760

**China - Wuhan**  
Tel: 86-27-5980-5300  
Fax: 86-27-5980-5118

**China - Xiamen**  
Tel: 86-592-2388138  
Fax: 86-592-2388130

**China - Xian**  
Tel: 86-29-8833-7252  
Fax: 86-29-8833-7256

**China - Zhuhai**  
Tel: 86-756-3210040  
Fax: 86-756-3210049

### ASIA/PACIFIC

**India - Bangalore**  
Tel: 91-80-4182-8400  
Fax: 91-80-4182-8422

**India - New Delhi**  
Tel: 91-11-4160-8631  
Fax: 91-11-4160-8632

**India - Pune**  
Tel: 91-20-2566-1512  
Fax: 91-20-2566-1513

**Japan - Yokohama**  
Tel: 81-45-471- 6166  
Fax: 81-45-471-6122

**Korea - Daegu**  
Tel: 82-53-744-4301  
Fax: 82-53-744-4302

**Korea - Seoul**  
Tel: 82-2-554-7200  
Fax: 82-2-558-5932 or  
82-2-558-5934

**Malaysia - Kuala Lumpur**  
Tel: 60-3-6201-9857  
Fax: 60-3-6201-9859

**Malaysia - Penang**  
Tel: 60-4-227-8870  
Fax: 60-4-227-4068

**Philippines - Manila**  
Tel: 63-2-634-9065  
Fax: 63-2-634-9069

**Singapore**  
Tel: 65-6334-8870  
Fax: 65-6334-8850

**Taiwan - Hsin Chu**  
Tel: 886-3-572-9526  
Fax: 886-3-572-6459

**Taiwan - Kaohsiung**  
Tel: 886-7-536-4818  
Fax: 886-7-536-4803

**Taiwan - Taipei**  
Tel: 886-2-2500-6610  
Fax: 886-2-2508-0102

**Thailand - Bangkok**  
Tel: 66-2-694-1351  
Fax: 66-2-694-1350

### EUROPE

**Austria - Wels**  
Tel: 43-7242-2244-39  
Fax: 43-7242-2244-393

**Denmark - Copenhagen**  
Tel: 45-4450-2828  
Fax: 45-4485-2829

**France - Paris**  
Tel: 33-1-69-53-63-20  
Fax: 33-1-69-30-90-79

**Germany - Munich**  
Tel: 49-89-627-144-0  
Fax: 49-89-627-144-44

**Italy - Milan**  
Tel: 39-0331-742611  
Fax: 39-0331-466781

**Netherlands - Drunen**  
Tel: 31-416-690399  
Fax: 31-416-690340

**Spain - Madrid**  
Tel: 34-91-708-08-90  
Fax: 34-91-708-08-91

**UK - Wokingham**  
Tel: 44-118-921-5869  
Fax: 44-118-921-5820

Компания «Океан Электроники» предлагает заключение долгосрочных отношений при поставках импортных электронных компонентов на взаимовыгодных условиях!

Наши преимущества:

- Поставка оригинальных импортных электронных компонентов напрямую с производств Америки, Европы и Азии, а так же с крупнейших складов мира;
- Широкая линейка поставок активных и пассивных импортных электронных компонентов (более 30 млн. наименований);
- Поставка сложных, дефицитных, либо снятых с производства позиций;
- Оперативные сроки поставки под заказ (от 5 рабочих дней);
- Экспресс доставка в любую точку России;
- Помощь Конструкторского Отдела и консультации квалифицированных инженеров;
- Техническая поддержка проекта, помощь в подборе аналогов, поставка прототипов;
- Поставка электронных компонентов под контролем ВП;
- Система менеджмента качества сертифицирована по Международному стандарту ISO 9001;
- При необходимости вся продукция военного и аэрокосмического назначения проходит испытания и сертификацию в лаборатории (по согласованию с заказчиком);
- Поставка специализированных компонентов военного и аэрокосмического уровня качества (Xilinx, Altera, Analog Devices, Intersil, Interpoint, Microsemi, Actel, Aeroflex, Peregrine, VPT, Syfer, Eurofarad, Texas Instruments, MS Kennedy, Miteq, Cobham, E2V, MA-COM, Hittite, Mini-Circuits, General Dynamics и др.);

Компания «Океан Электроники» является официальным дистрибьютором и эксклюзивным представителем в России одного из крупнейших производителей разъемов военного и аэрокосмического назначения «JONHON», а так же официальным дистрибьютором и эксклюзивным представителем в России производителя высокотехнологичных и надежных решений для передачи СВЧ сигналов «FORSTAR».



## JONHON

«JONHON» (основан в 1970 г.)

Разъемы специального, военного и аэрокосмического назначения:

(Применяются в военной, авиационной, аэрокосмической, морской, железнодорожной, горно- и нефтедобывающей отраслях промышленности)

«FORSTAR» (основан в 1998 г.)

ВЧ соединители, коаксиальные кабели, кабельные сборки и микроволновые компоненты:

(Применяются в телекоммуникациях гражданского и специального назначения, в средствах связи, РЛС, а так же военной, авиационной и аэрокосмической отраслях промышленности).



Телефон: 8 (812) 309-75-97 (многоканальный)

Факс: 8 (812) 320-03-32

Электронная почта: [ocean@oceanchips.ru](mailto:ocean@oceanchips.ru)

Web: <http://oceanchips.ru/>

Адрес: 198099, г. Санкт-Петербург, ул. Калинина, д. 2, корп. 4, лит. А