

42 V Input Ultra Low Supply Current VR with RESET for Automotive Applications

No. EC-376-190708

OUTLINE

R5112S is an ultra-low supply current voltage regulator with a voltage detector featuring 200 mA output current and 42 V input voltage. This device consists of an Output Short-circuit Protection Circuit, an Overcurrent Protection Circuit, and a Thermal Shutdown Circuit in addition to the basic regulator circuits. The operating temperature range is between -40°C to 125°C , and the maximum input voltage is 42 V. The output voltages are internally fixed at either of the following: 1.8 V, 2.5 V, 2.8 V, 3.0 V, 3.3 V, 3.4 V, or 5.0 V. The output voltage accuracy is $\pm 0.6\%$. The detector threshold accuracy of the voltage detector is $\pm 0.6\%$. This device is offered in an 8-pin HSOP-8E package with high power dissipation.

FEATURES

- Input Voltage Range (Maximum Rating)..... 3.5 V to 42 V (50 V)
- Operating Temperature Range..... -40°C to 125°C
- Supply Current..... Typ. $3.8\ \mu\text{A}$
- Standby Current..... Typ. $0.1\ \mu\text{A}$
- Dropout Voltage..... Typ. 0.6 V ($I_{\text{OUT}} = 200\ \text{mA}$, $V_{\text{SET}} = 5.0\ \text{V}$)
- Output Voltage Range..... 1.8 V / 2.5 V / 2.8 V / 3.0 V / 3.3 V / 3.4 V / 5.0 V
*Contact Ricoh sales representatives for other voltages.
- Output Voltage Accuracy..... $\pm 0.6\%$ ($T_a = 25^{\circ}\text{C}$)
- Output Voltage Temperature-Drift Coefficient..... Typ. $\pm 60\ \text{ppm}/^{\circ}\text{C}$
- Detector Threshold Range..... R5112Sxx1B: 1.6 V to 4.8 V
R5112Sxx1D: 2.9 V to 4.8 V
- Detector Threshold Accuracy..... $\pm 0.6\%$ ($T_a = 25^{\circ}\text{C}$)
- Detector Threshold Temperature Coefficient..... Typ. $\pm 60\ \text{ppm}/^{\circ}\text{C}$
- Line Regulation..... Typ. 0.01%/V ($2.5\ \text{V} \leq V_{\text{SET}}; V_{\text{SET}} + 1\ \text{V} \leq V_{\text{IN}} \leq 42\ \text{V}$)
- Built-in Output Short-circuit Protection Circuit..... Typ. 80 mA
- Built-in Overcurrent Protection Circuit..... Typ. 350 mA
- Built-in Thermal Shutdown Circuit..... Thermal Shutdown Temperature: Typ. 170°C
- Ceramic capacitors are recommended
to be used with this device..... $C_{\text{OUT}} = 0.1\ \mu\text{F}$ or more
- Package..... HSOP-8E

APPLICATIONS

- Power source for accessories such as car audios, car navigation systems, and ETC systems
- Power source for ECUs such as EV inverter and battery charge control unit

R5112S

No. EC-376-190708

SELECTION GUIDE

The set output voltage and the automotive class code are user-selectable.

Product Name	Package	Quantity per Reel	Pb Free	Halogen Free
R5112Sxx1*-E2-#E	HSOP-8E	1,000 pcs	Yes	Yes

xx: Specify the set output voltage (V_{SET}) and the set detector threshold ($-V_{SET}$) by using serial numbers starting from 01.⁽¹⁾

*: Select the voltage detection type from the following
B: SENSE pin detection
D: VOUT pin detection

#: Select the quality class

	Operating Temperature Range	Test Temperature
A	-40°C to 125°C	25°C , High
K	-40°C to 125°C	High , 25°C , Low

⁽¹⁾ The combinations of V_{SET} and $-V_{SET}$ are the following three conditions.
SENSE pin detection: $V_{SET} = 3.3\text{ V to }5.0\text{ V}$, $-V_{SET} = 2.5\text{ V to }5.0\text{ V}$
SENSE pin detection: $V_{SET} = 1.8\text{ V to }3.2\text{ V}$, $-V_{SET} = 1.6\text{ V to }2.9\text{ V}$
VOUT pin detection: $V_{SET} = 3.3\text{ V to }5.0\text{ V}$, $-V_{SET} = 2.9\text{ V to }5.0\text{ V}$

BLOCK DIAGRAMS

**R5112SxxxB
(SENSE Pin Detection)**

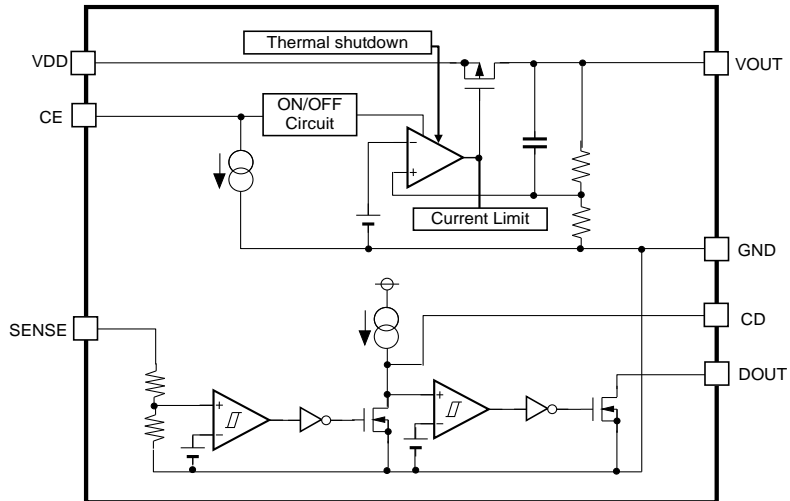

**R5112SxxxD
(VOUT Pin Detection)**

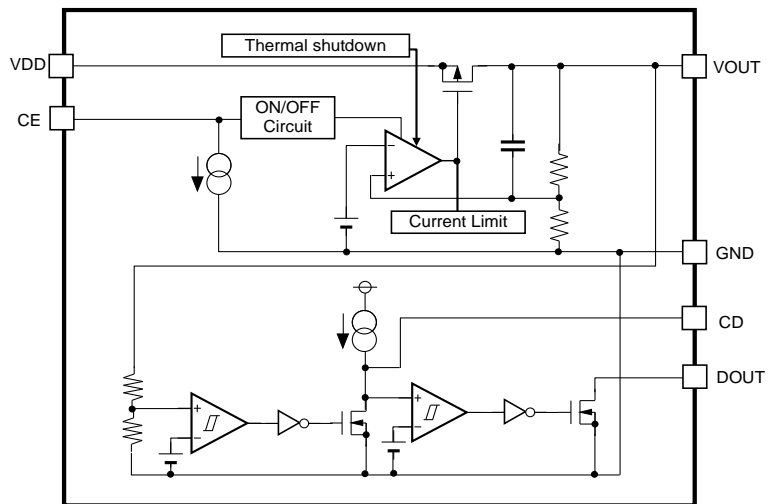

R5112S

No. EC-376-190708

PIN DESCRIPTIONS

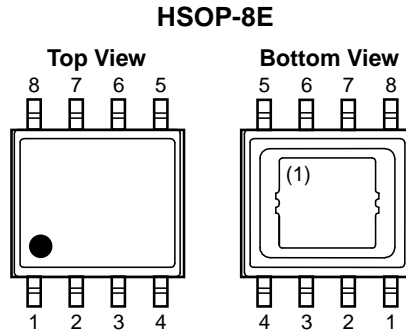

HSOP-8E (R5112SxxxB/D)

Pin No.	Symbol	Description
1	VDD	Input Pin
2	CE	Chip Enable Pin (Active-high)
3	NC ⁽³⁾	No Connection
4	DOUT ⁽²⁾	VD Output Pin (Nch Open Drain)
5	CD	Pin for setting VD Release Output Delay Time (power-on reset time)
6	SENSE	VD Voltage SENSE Pin (R5112SxxxB)
	NC ⁽³⁾	No Connection (R5112SxxxD)
7	GND	Ground Pin
8	VOUT	Output Pin

⁽¹⁾ The tab on the bottom of the package enhances thermal performance and is electrically connected to GND (substrate level). The tab is recommended to connect to the ground plane on the board. Otherwise it may be left floating.

⁽²⁾ DOUT pin should be pulled-up to an external voltage level.

⁽³⁾ NC pin is recommended to connect to the ground plane on the board. Otherwise it may be left floating

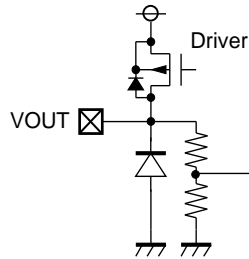
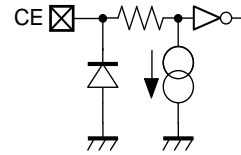
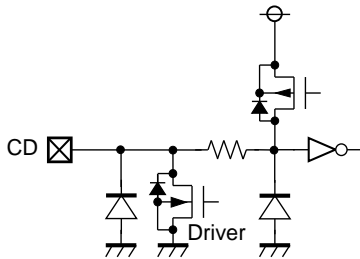
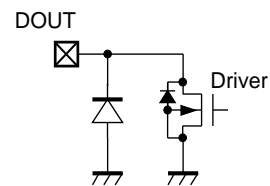
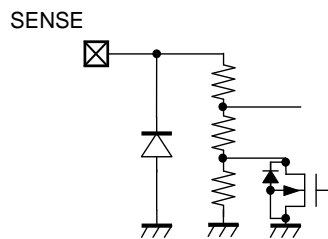
PIN EQUIVALENT CIRCUIT DIAGRAMS**VOUT Pin****CE Pin****CD Pin****DOUT Pin****SENSE Pin**

R5112S

No. EC-376-190708

ABSOLUTE MAXIMUM RATINGS

Symbol	Item	Rating	Unit
V_{IN}	Input Voltage	-0.3 to 50	V
	Peak Input Voltage ⁽¹⁾	60	V
V_{CE}	Input Voltage (CE Pin)	-0.3 to 50	V
V_{OUT}	Output Voltage	$-0.3 \text{ to } V_{IN} + 0.3 \leq 50$	V
V_{CD}	CD Pin Output Voltage	-0.3 to 7.0	V
V_{DOUT}	DOUT Pin Output Voltage	-0.3 to 7.0	V
V_{SENSE}	SENSE Pin Input Voltage	-0.3 to 7.0	V
I_{DOUT}	DOUT Pin Current	16	mA
P_D	Power Dissipation ⁽²⁾ (HSOP-8E, JEDEC STD. 51-7)	3600	mW
T_j	Junction Temperature	-40 to 150	°C
T_{stg}	Storage Temperature	-55 to 150	°C

ABSOLUTE MAXIMUM RATINGS

Electronic and mechanical stress momentarily exceeded absolute maximum ratings may cause permanent damage and may degrade the lifetime and safety for both device and system using the device in the field. The functional operation at or over these absolute maximum ratings are not assured.

RECOMMENDED OPERATING CONDITIONS

Symbol	Item	Rating	Unit
V_{IN}	Input Voltage	3.5 to 42	V
V_{CE}	Input Voltage (CE Pin)	0 to 42	V
V_{DOUT}	DOUT Pin Output Voltage	0 to 5.5	V
V_{SENSE}	SENSE Pin Input Voltage	0 to 5.5	V
T_a	Operating Temperature	-40 to 125	°C

RECOMMENDED OPERATING CONDITIONS

All of electronic equipment should be designed that the mounted semiconductor devices operate within the recommended operating conditions. The semiconductor devices cannot operate normally over the recommended operating conditions, even if they are used over such conditions by momentary electronic noise or surge. And the semiconductor devices may receive serious damage when they continue to operate over the recommended operating conditions.

⁽¹⁾ Duration time: 200 ms

⁽²⁾ Refer to *POWER DISSIPATION* for detailed information.

ELECTRICAL CHARACTERISTICS

$C_{IN} = C_{OUT} = 0.1 \mu\text{F}$, $V_{IN} = 14 \text{ V}$, unless otherwise noted.

The specifications surrounded by are guaranteed by design engineering at $-40^\circ\text{C} \leq T_a \leq 125^\circ\text{C}$.

R5112Sxxxx-AE

For All

($T_a = 25^\circ\text{C}$)

Symbol	Item	Conditions	Min.	Typ.	Max.	Unit
I_{SS}	Supply Current	$I_{OUT} = 0 \text{ mA}$		3.8	9.8	μA
$I_{standby}$	Standby Current	$V_{IN} = 42 \text{ V}$, $V_{CE} = 0 \text{ V}$		0.1	1.0	μA
I_{PD}	CE Pull-down Current			0.2	0.6	μA
V_{CEH}	CE Input Voltage "H"		2.2		42	V
V_{CEL}	CE Input Voltage "L"		0		1.0	V

All test items listed under Electrical Characteristics are done under the pulse load condition ($T_j \approx T_a = 25^\circ\text{C}$).

VR

($T_a = 25^\circ\text{C}$)

Symbol	Item	Conditions	Min.	Typ.	Max.	Unit	
V_{OUT}	Output Voltage	$V_{SET} + 1 \text{ V} \leq V_{IN} \leq 42 \text{ V}$ ($V_{SET} < 2.5 \text{ V}$: $V_{SET} + 1 \text{ V} = 3.5 \text{ V}$), $I_{OUT} = 1 \text{ mA}$	$T_a = 25^\circ\text{C}$ $-40^\circ\text{C} \leq T_a \leq 125^\circ\text{C}$	$\times 0.994$		$\times 1.006$	V
$\frac{\Delta V_{OUT}}{\Delta I_{OUT}}$	Load Regulation	$V_{IN} = V_{SET} + 3.0 \text{ V}$ $1 \text{ mA} \leq I_{OUT} \leq 200 \text{ mA}$		-10	0	40	mV
V_{DIF}	Dropout Voltage	$I_{OUT} = 200 \text{ mA}$					V
		$V_{SET} < 2.5 \text{ V}$		1.6	2.5		
		$2.5 \text{ V} \leq V_{SET} < 3.3 \text{ V}$		1.2	2.2		
		$3.3 \text{ V} \leq V_{SET} < 5.0 \text{ V}$		0.8	2.0		
		$V_{SET} = 5.0 \text{ V}$		0.6	1.2		
$\frac{\Delta V_{OUT}}{\Delta V_{IN}}$	Line Regulation	$V_{SET} + 1 \text{ V} \leq V_{IN} \leq 42 \text{ V}$ ($V_{SET} < 2.5 \text{ V}$: $V_{SET} + 1 \text{ V} = 3.5 \text{ V}$), $I_{OUT} = 1 \text{ mA}$		-0.02	0.01	0.02	%/V
I_{LIM}	Output Current Limit	$V_{IN} = V_{SET} + 3.0 \text{ V}$		220	350	420	mA
I_{SC}	Short current Limit	$V_{OUT} = 0 \text{ V}$		60	80	110	mA
T_{TSD}	Thermal Shutdown Detection Temperature	Junction Temperature		170			$^\circ\text{C}$
T_{TSR}	Thermal Shutdown Release Temperature	Junction Temperature		135			$^\circ\text{C}$

All test items listed under Electrical Characteristics are done under the pulse load condition ($T_j \approx T_a = 25^\circ\text{C}$).

R5112S

No. EC-376-190708

 $C_{IN} = C_{OUT} = 0.1 \mu F$, $V_{IN} = 14 V$, unless otherwise noted.The specifications surrounded by \square are guaranteed by design engineering at $-40^{\circ}C \leq T_a \leq 125^{\circ}C$.**VD**

(Ta = 25°C)

Symbol	Item	Conditions	Min.	Typ.	Max.	Unit	
$-V_{DET}$	Detector Threshold	$V_{DD} = V_{OUT}$ (V_{OUT} detection)	Ta = 25°C	$\times 0.994$		$\times 1.006$	V
			$-40^{\circ}C \leq T_a \leq 125^{\circ}C$	$\square \times 0.984$		$\square \times 1.016$	
V_{HYS}	Detector Threshold Hysteresis		$\frac{-V_{DET}}{\square \times 0.011}$	$\frac{-V_{DET}}{\times 0.018}$	$\frac{-V_{DET}}{\square \times 0.025}$	V	
t _{delay}	Release Output Delay Time (Power-on Reset)	$C_D = 10 \text{ nF}$	$\square 3$	6	$\square 15$	ms	
V_{DOUT}	D _{OUT} Pull-up Voltage				$\square 5.5$	V	
I _{OUTDOUT}	Nch. Output Current (D _{OUT} Output Pin)	$V_{IN} = 3.5 \text{ V}$, $V_{DOUT} = 0.1 \text{ V}$	$\square 1.0$	2.6		mA	
I _{LEAKDOUT}	Nch. Leakage Current (D _{OUT} Output Pin)	$V_{DOUT} = 5.5 \text{ V}$			$\square 0.3$	μA	
R _{LCD}	C _D Pin Discharge Nch Tr.ON Resistance	$V_{CE} = 0 \text{ V}$, $V_{CD} = 0.1 \text{ V}$		12	$\square 30$	kΩ	
R _{SENSE}	SENSE Resistance		$\square 2$		$\square 50$	MΩ	

All test items listed under Electrical Characteristics are done under the pulse load condition ($T_j \approx T_a = 25^{\circ}C$).

Product-specific Electrical Characteristics

R5112SxxxB-AE

(Ta = 25°C)

Product Name	V _{OUT} [V]					V _{DET} [V]					V _{HYS} [V]	
	Ta = 25°C			-40°C ≤ Ta ≤ 125°C		Ta = 25°C			-40°C ≤ Ta ≤ 125°C		Min.	Max.
	Min.	Typ.	Max.	Min.	Max.	Min.	Typ.	Max.	Min.	Max.		
R5112x011B	4.970	5.000	5.030	4.920	5.080	4.573	4.600	4.627	4.527	4.674	0.050	0.117
R5112x021B	1.790	1.800	1.810	1.772	1.829	1.590	1.600	1.610	1.574	1.626	0.017	0.041
R5112x031B	4.970	5.000	5.030	4.920	5.080	4.473	4.500	4.527	4.428	4.572	0.049	0.115
R5112x041B	4.970	5.000	5.030	4.920	5.080	4.374	4.400	4.426	4.330	4.470	0.048	0.112
R5112x051B	4.970	5.000	5.030	4.920	5.080	4.274	4.300	4.326	4.231	4.369	0.047	0.110
R5112x061B	4.970	5.000	5.030	4.920	5.080	4.175	4.200	4.225	4.133	4.267	0.045	0.107
R5112x071B	4.970	5.000	5.030	4.920	5.080	3.678	3.700	3.722	3.641	3.759	0.040	0.094
R5112x081B	3.281	3.300	3.319	3.248	3.353	2.982	3.000	3.018	2.952	3.048	0.032	0.077
R5112x091B	3.281	3.300	3.319	3.248	3.353	2.883	2.900	2.917	2.854	2.946	0.031	0.074
R5112x101B	3.281	3.300	3.319	3.248	3.353	2.783	2.800	2.817	2.755	2.845	0.030	0.071
R5112x111B	3.281	3.300	3.319	3.248	3.353	2.684	2.700	2.716	2.657	2.743	0.029	0.069
R5112x121B	4.970	5.000	5.030	4.920	5.080	4.075	4.100	4.125	4.034	4.166	0.044	0.105
R5112x131B	3.380	3.400	3.420	3.346	3.454	3.081	3.100	3.119	3.050	3.150	0.034	0.079
R5112x141B	3.281	3.300	3.319	3.248	3.353	3.081	3.100	3.119	3.050	3.150	0.034	0.079
R5112x151B	4.970	5.000	5.030	4.920	5.080	2.982	3.000	3.018	2.952	3.048	0.032	0.077
R5112x161B	2.982	3.000	3.018	2.952	3.048	2.684	2.700	2.716	2.657	2.743	0.029	0.069

R5112SxxxD-AE

(Ta = 25°C)

Product Name	V _{OUT} [V]					V _{DET} [V]					V _{HYS} [V]	
	Ta = 25°C			-40°C ≤ Ta ≤ 125°C		Ta = 25°C			-40°C ≤ Ta ≤ 125°C		Min.	Max.
	Min.	Typ.	Max.	Min.	Max.	Min.	Typ.	Max.	Min.	Max.		
R5112x011D	4.970	5.000	5.030	4.920	5.080	4.573	4.600	4.627	4.527	4.674	0.068	0.117
R5112x031D	4.970	5.000	5.030	4.920	5.080	4.473	4.500	4.527	4.428	4.572	0.066	0.115
R5112x041D	4.970	5.000	5.030	4.920	5.080	4.374	4.400	4.426	4.330	4.470	0.065	0.112
R5112x051D	4.970	5.000	5.030	4.920	5.080	4.274	4.300	4.326	4.231	4.369	0.063	0.110
R5112x061D	4.970	5.000	5.030	4.920	5.080	4.175	4.200	4.225	4.133	4.267	0.062	0.107
R5112x071D	4.970	5.000	5.030	4.920	5.080	3.678	3.700	3.722	3.641	3.759	0.054	0.094
R5112x081D	3.281	3.300	3.319	3.248	3.353	2.982	3.000	3.018	2.952	3.048	0.044	0.077
R5112x091D	3.281	3.300	3.319	3.248	3.353	2.883	2.900	2.917	2.854	2.946	0.043	0.074
R5112x121D	4.970	5.000	5.030	4.920	5.080	4.075	4.100	4.125	4.034	4.166	0.060	0.105
R5112x131D	3.380	3.400	3.420	3.346	3.454	3.081	3.100	3.119	3.050	3.150	0.046	0.079
R5112x141D	3.281	3.300	3.319	3.248	3.353	3.081	3.100	3.119	3.050	3.150	0.046	0.079
R5112x151D	4.970	5.000	5.030	4.920	5.080	2.982	3.000	3.018	2.952	3.048	0.032	0.077

R5112S

No. EC-376-190708

 $C_{IN} = C_{OUT} = 0.1 \mu\text{F}$, $V_{IN} = 14 \text{ V}$, unless otherwise noted.**R5112Sxxxx-KE****For All**($-40^{\circ}\text{C} \leq T_a \leq 125^{\circ}\text{C}$)

Symbol	Item	Conditions	Min.	Typ.	Max.	Unit
I_{SS}	Supply Current	$I_{OUT} = 0 \text{ mA}$		3.8	9.8	μA
$I_{standby}$	Standby Current	$V_{IN} = 42 \text{ V}$, $V_{CE} = 0 \text{ V}$		0.1	1.0	μA
I_{PD}	CE Pull-down Current	$V_{CE} = 2 \text{ V}$		0.2	0.6	μA
V_{CEH}	CE Input Voltage "H"		2.2		42	V
V_{CEL}	CE Input Voltage "L"		0		1.0	V

VR($-40^{\circ}\text{C} \leq T_a \leq 125^{\circ}\text{C}$)

Symbol	Item	Conditions	Min.	Typ.	Max.	Unit	
V_{OUT}	Output Voltage	$V_{SET} + 1 \text{ V} \leq V_{IN} \leq 42 \text{ V}$ ($V_{SET} < 2.5 \text{ V}$: $V_{SET} + 1 \text{ V} = 3.5 \text{ V}$), $I_{OUT} = 1 \text{ mA}$	$T_a = 25^{\circ}\text{C}$	$\times 0.994$		$\times 1.006$	V
			$-40^{\circ}\text{C} \leq T_a \leq 125^{\circ}\text{C}$	$\times 0.984$		$\times 1.016$	
$\frac{\Delta V_{OUT}}{\Delta I_{OUT}}$	Load Regulation	$V_{IN} = V_{SET} + 3.0 \text{ V}$ $1 \text{ mA} \leq I_{OUT} \leq 200 \text{ mA}$	-10	0	40	mV	
V_{DIF}	Dropout Voltage	$I_{OUT} = 200 \text{ mA}$	$V_{SET} < 2.5 \text{ V}$		1.6	2.5	V
			$2.5 \text{ V} \leq V_{SET} < 3.3 \text{ V}$		1.2	2.2	
			$3.3 \text{ V} \leq V_{SET} < 5.0 \text{ V}$		0.8	2.0	
			$V_{SET} = 5.0 \text{ V}$		0.6	1.2	
$\frac{\Delta V_{OUT}}{\Delta V_{IN}}$	Line Regulation	$V_{SET} + 1 \text{ V} \leq V_{IN} \leq 42 \text{ V}$ ($V_{SET} < 2.5 \text{ V}$: $V_{SET} + 1 \text{ V} = 3.5 \text{ V}$), $I_{OUT} = 1 \text{ mA}$	-0.02	0.01	0.02	%/V	
I_{LIM}	Output Current Limit	$V_{IN} = V_{SET} + 3.0 \text{ V}$	220	350	420	mA	
I_{SC}	Short current Limit	$V_{OUT} = 0 \text{ V}$	60	80	110	mA	
T_{TSD}	Thermal Shutdown Temperature	Junction Temperature	150	170		$^{\circ}\text{C}$	
T_{TSR}	Thermal Shutdown Release Temperature	Junction Temperature	125	135		$^{\circ}\text{C}$	

$C_{IN} = C_{OUT} = 0.1 \mu\text{F}$, $V_{IN} = 14 \text{ V}$, unless otherwise noted.

VD

($-40^\circ\text{C} \leq T_a \leq 125^\circ\text{C}$)

Symbol	Item	Conditions	Min.	Typ.	Max.	Unit	
$-V_{DET}$	Detector Threshold	$V_{DD} = V_{OUT}$ (V_{OUT} detection)	$T_a = 25^\circ\text{C}$	$\times 0.994$		$\times 1.006$	V
			$-40^\circ\text{C} \leq T_a \leq 125^\circ\text{C}$	$\times 0.984$		$\times 1.016$	
V_{HYS}	Detector Threshold Hysteresis		$-V_{DET}$ $\times 0.011$	$-V_{DET}$ $\times 0.018$	$-V_{DET}$ $\times 0.025$	V	
t_{delay}	Release Output Delay Time (Power-on Reset)	$C_D = 10 \text{ nF}$	3	6	15	ms	
V_{DOUT}	D_{OUT} Pull-up Voltage				5.5	V	
$I_{OUTDOUT}$	Nch. Output Current (D_{OUT} Output Pin)	$V_{IN} = 3.5 \text{ V}$, $V_{DOUT} = 0.1 \text{ V}$	1.0	2.6		mA	
$I_{LEAKDOUT}$	Nch. Leakage Current (D_{OUT} Output Pin)	$V_{DOUT} = 5.5 \text{ V}$			0.3	μA	
R_{LCD}	C_D Pin Discharge Nch Tr.ON Resistance	$V_{CE} = 0 \text{ V}$, $V_{CD} = 0.1 \text{ V}$		12	30	k Ω	
R_{SENSE}	SENSE Resistance		2		50	M Ω	

R5112S

No. EC-376-190708

Product-specific Electrical Characteristics

R5112SxxxB-KE

($-40^{\circ}\text{C} \leq T_a \leq 125^{\circ}\text{C}$)

Product Name	V _{OUT} [V]					V _{DET} [V]					V _{HYS} [V]	
	Ta = 25°C			-40°C ≤ Ta ≤ 125°C		Ta = 25°C			-40°C ≤ Ta ≤ 125°C			
	Min.	Typ.	Max.	Min.	Max.	Min.	Typ.	Max.	Min.	Max.	Min.	Max.
R5112x011B	4.970	5.000	5.030	4.920	5.080	4.573	4.600	4.627	4.527	4.674	0.050	0.117
R5112x021B	1.790	1.800	1.810	1.772	1.829	1.590	1.600	1.610	1.574	1.626	0.017	0.041
R5112x031B	4.970	5.000	5.030	4.920	5.080	4.473	4.500	4.527	4.428	4.572	0.049	0.115
R5112x041B	4.970	5.000	5.030	4.920	5.080	4.374	4.400	4.426	4.330	4.470	0.048	0.112
R5112x051B	4.970	5.000	5.030	4.920	5.080	4.274	4.300	4.326	4.231	4.369	0.047	0.110
R5112x061B	4.970	5.000	5.030	4.920	5.080	4.175	4.200	4.225	4.133	4.267	0.045	0.107
R5112x071B	4.970	5.000	5.030	4.920	5.080	3.678	3.700	3.722	3.641	3.759	0.040	0.094
R5112x081B	3.281	3.300	3.319	3.248	3.353	2.982	3.000	3.018	2.952	3.048	0.032	0.077
R5112x091B	3.281	3.300	3.319	3.248	3.353	2.883	2.900	2.917	2.854	2.946	0.031	0.074
R5112x101B	3.281	3.300	3.319	3.248	3.353	2.783	2.800	2.817	2.755	2.845	0.030	0.071
R5112x111B	3.281	3.300	3.319	3.248	3.353	2.684	2.700	2.716	2.657	2.743	0.029	0.069
R5112x121B	4.970	5.000	5.030	4.920	5.080	4.075	4.100	4.125	4.034	4.166	0.044	0.105
R5112x131B	3.380	3.400	3.420	3.346	3.454	3.081	3.100	3.119	3.050	3.150	0.034	0.079
R5112x141B	3.281	3.300	3.319	3.248	3.353	3.081	3.100	3.119	3.050	3.150	0.034	0.079
R5112x151B	4.970	5.000	5.030	4.920	5.080	2.982	3.000	3.018	2.952	3.048	0.032	0.077
R5112x161B	2.982	3.000	3.018	2.952	3.048	2.684	2.700	2.716	2.657	2.743	0.029	0.069

R5112SxxxD-KE

($-40^{\circ}\text{C} \leq T_a \leq 125^{\circ}\text{C}$)

Product Name	V _{OUT} [V]					V _{DET} [V]					V _{HYS} [V]	
	Ta = 25°C			-40°C ≤ Ta ≤ 125°C		Ta = 25°C			-40°C ≤ Ta ≤ 125°C			
	Min.	Typ.	Max.	Min.	Max.	Min.	Typ.	Max.	Min.	Max.	Min.	Max.
R5112x011D	4.970	5.000	5.030	4.920	5.080	4.573	4.600	4.627	4.527	4.674	0.068	0.117
R5112x031D	4.970	5.000	5.030	4.920	5.080	4.473	4.500	4.527	4.428	4.572	0.066	0.115
R5112x041D	4.970	5.000	5.030	4.920	5.080	4.374	4.400	4.426	4.330	4.470	0.065	0.112
R5112x051D	4.970	5.000	5.030	4.920	5.080	4.274	4.300	4.326	4.231	4.369	0.063	0.110
R5112x061D	4.970	5.000	5.030	4.920	5.080	4.175	4.200	4.225	4.133	4.267	0.062	0.107
R5112x071D	4.970	5.000	5.030	4.920	5.080	3.678	3.700	3.722	3.641	3.759	0.054	0.094
R5112x081D	3.281	3.300	3.319	3.248	3.353	2.982	3.000	3.018	2.952	3.048	0.044	0.077
R5112x091D	3.281	3.300	3.319	3.248	3.353	2.883	2.900	2.917	2.854	2.946	0.043	0.074
R5112x121D	4.970	5.000	5.030	4.920	5.080	4.075	4.100	4.125	4.034	4.166	0.060	0.105
R5112x131D	3.380	3.400	3.420	3.346	3.454	3.081	3.100	3.119	3.050	3.150	0.046	0.079
R5112x141D	3.281	3.300	3.319	3.248	3.353	3.081	3.100	3.119	3.050	3.150	0.046	0.079
R5112x151D	4.970	5.000	5.030	4.920	5.080	2.982	3.000	3.018	2.952	3.048	0.032	0.077

THEORY OF OPERATION

Timing Chart

R5112SxxxB/D Voltage Detector

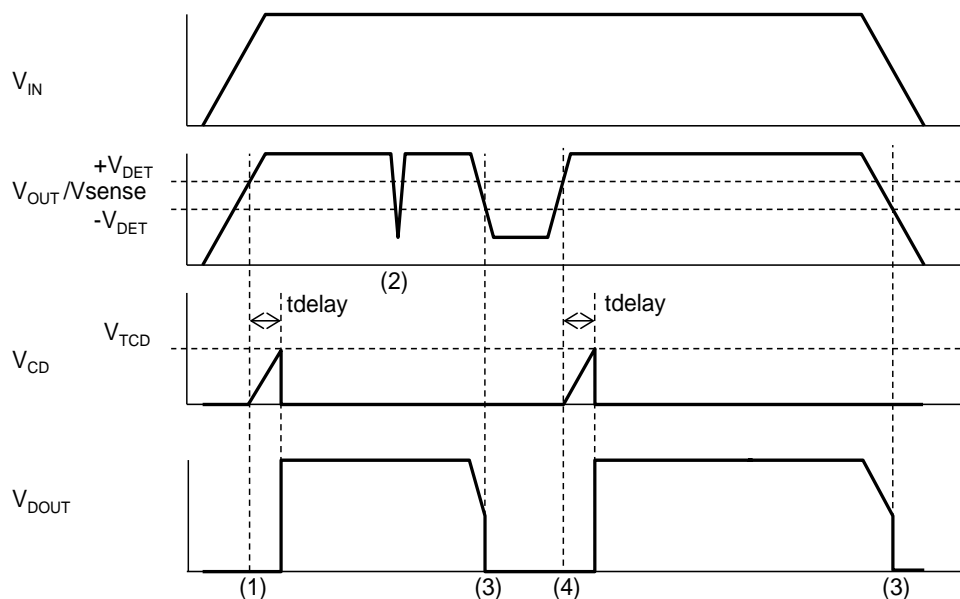

R5112SxxxB/D VD Timing Chart

- (1) When the V_{OUT} pin voltage (V_{OUT})/SENSE pin voltage (V_{SENSE}) becomes more than the release voltage ($+V_{DET}$), the D_{OUT} pin voltage (V_{DOUT}) becomes "H" after the release output delay time (t_{delay}).
- (2) When the detect output delay time is 25 μs (Typ.) or less even if V_{OUT}/V_{SENSE} becomes lower than the detector threshold ($-V_{DET}$), the voltage detector (VD) does not go into the detecting state.
- (3) When V_{OUT}/V_{SENSE} becomes lower than $-V_{DET}$, V_{DOUT} becomes "L" after the detect output delay time (t_{PHL} , Typ. 25 μs) and the VD goes into the detecting state.
- (4) When V_{OUT}/V_{SENSE} becomes more than $+V_{DET}$, V_{DOUT} becomes "H" after the release output delay time ($V_{TCD} = \text{Typ. } 0.73 \text{ V}$).

Delay Operation and Released Output Delay Time (tdelay)

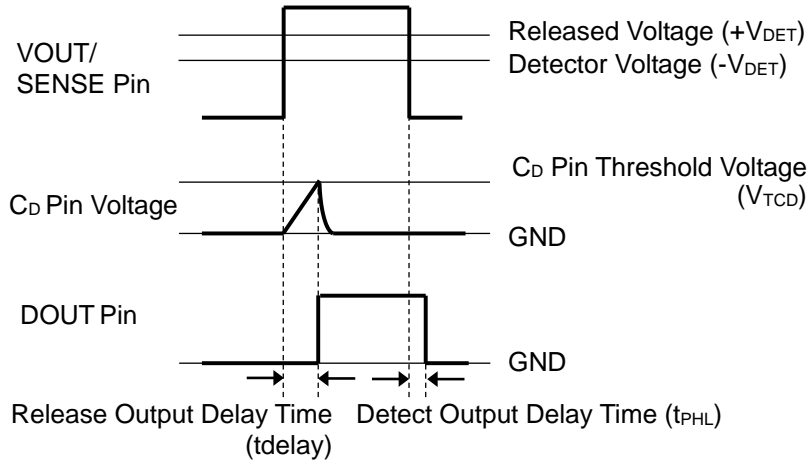

Released Output Delay Timing Diagram

When the operating voltage higher than the released voltage is applied to VOUT pin (R5112SxxxD) or SENSE pin (R5112SxxxB), charge to an external capacitor starts, then C_D pin voltage (V_{CD}) increases. DOUT pin (R5112SxxxB/D) maintains the released output until V_{CD} reaches the threshold voltage of the release output delay pin (V_{TCD}). And when V_{CD} is over V_{TCD}, DOUT pin is inverted from “L” to “H”. That is, the charged external capacitor starts discharging.

When the operating voltage lower than the detector threshold is applied to VOUT pin/SENSE pin, the detect output delay time, which is the time until the output voltage is inverted from “H” to “L”, remains constant independent of the external capacitor.

Released Output Delay Time

Released Output Delay Time (tdelay) is determined by the following formula. C_D (F) represents capacitance of the external capacitor

$$tdelay (s) = 0.73 \times C_D (F) / (1.2 \times 10^{-6})$$

Use 100 pF or higher C_D when allowing this device to detect VOUT/SENSE pin decreasing slower than 0.1 V/s. Released Output Delay Time indicates the time between the instance when VOUT pin (R5112SxxxD) or SENSE pin (R5112SxxxB) shifts from “1.5 V” to “-V_{DET} + 2.0 V” by the application of a pulse voltage and the instance when the output voltage reaches 2.5 V after pulled up DOUT pin (R5112SxxxB/D) to 5.0 V with a resistor of 100 kΩ.

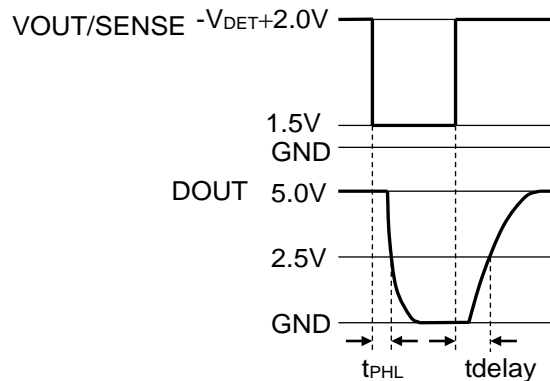

Voltage Setting (R5112SxxxB/D)

VD detects the drop of the VR output voltage (V_{OUT}). When the VD release voltage ($+V_{DET}$) is set to a voltage above the VR output voltage, the reset signal of VD is not released even if VD monitors the VR output voltage returns to the normal value after detecting the drop of VR. To prevent this issue, the following condition is required between V_{OUT} and $+V_{DET}$.

$$(VR \text{ Set Output Voltage}) \times 0.984 - 40 \text{ mV} > (VD \text{ Set Detector Threshold}) \times 1.016 \times 1.025$$

When using a device without the above conditions of V_{OUT} and $+V_{DET}$, careful consideration must be given to the system operation before use.

Standby Function

When the CE pin voltage (V_{CE}) is low, the R5112S goes into the standby mode. During the standby mode, the voltage regulator (VR) stops the output, and the voltage detector (VD) stops the voltage monitoring. When V_{CE} is low, the DOUT pin voltage (V_{DOUT}) is fixed to low regardless of the V_{OUT} and SENSE pin voltage.

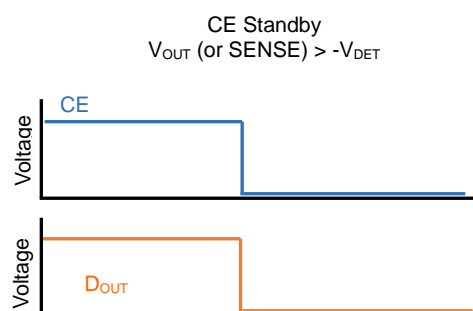

R5112S

No. EC-376-190708

APPLICATION INFORMATION

TYPICAL APPLICATIONS

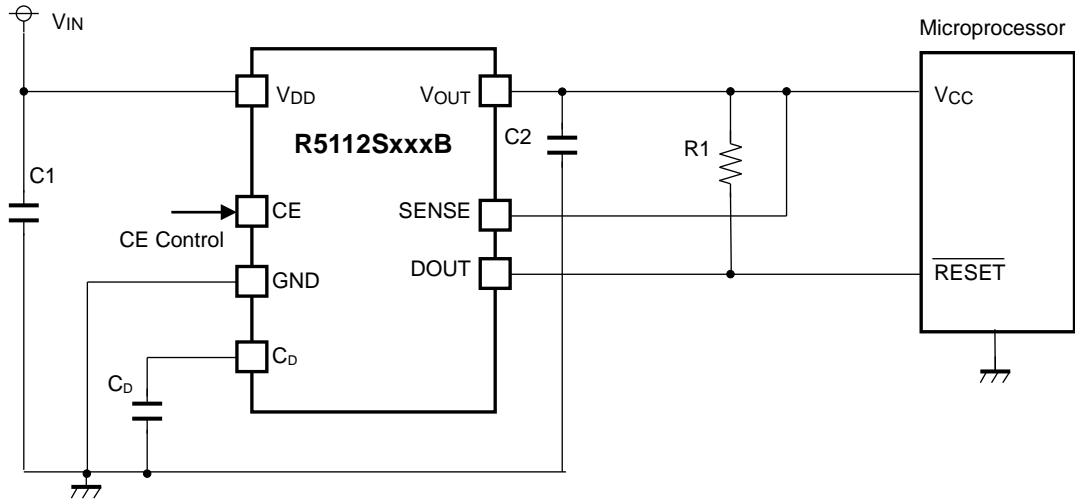

R5112SxxxB Typical Applications

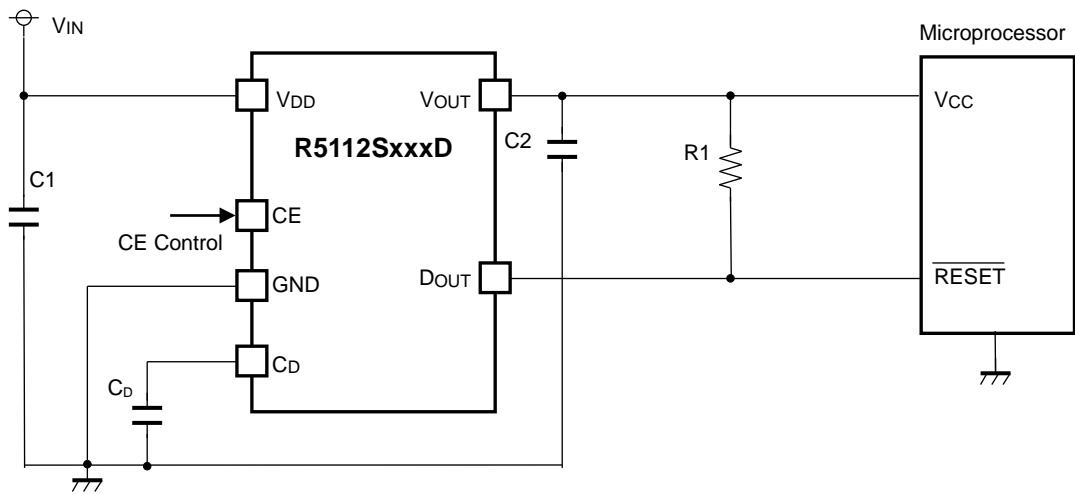

R5112SxxxD Typical Applications

Recommended Components

Symbol	Description
C1 (C _{IN})	Ceramic Capacitor, 0.1 μ F or more, 50V Rated Voltage, CGA3E3X8R1H104K080AB, TDK
C2 (C _{OUT})	Ceramic Capacitor, 0.1 μ F or more, 50V Rated Voltage, CGA3E3X8R1H104K080AB, TDK
C _D	A capacitor corresponding to setting for Release Output Delay Time is required. Refer to <i>Delay Operation and Released Output Delay Time (t_{delay})</i> in <i>THEORY OF OPERATION</i> for details.
R1	A resistor is required to set with consideration of the output current and the leakage current. Refer to <i>ELECTRICAL CHARACTERISTICS</i> for details.

TYPICAL APPLICATION FOR IC CHIP BREAKDOWN PREVENTION

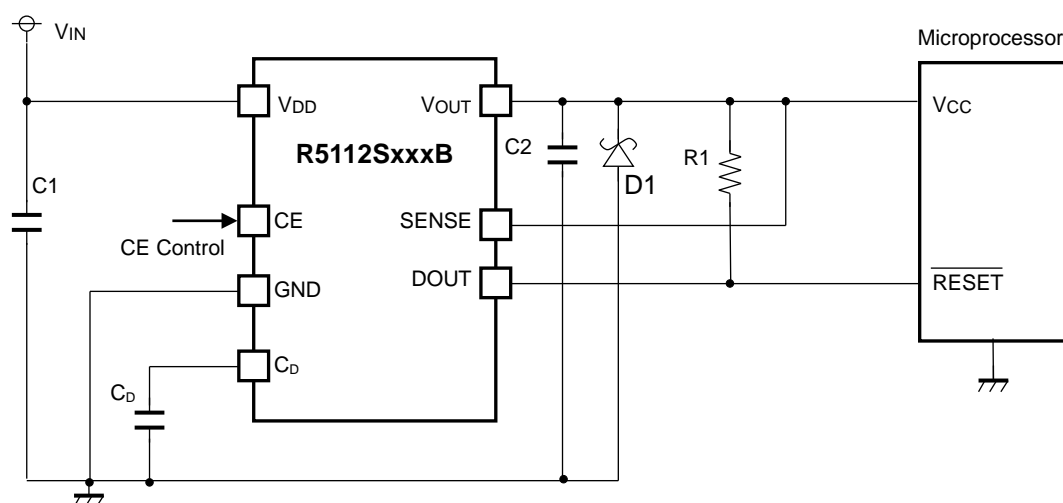

R5112SxxxB Typical Application for IC Chip Breakdown Prevention

When a sudden surge of electrical current travels along the VOUT pin and GND due to a short-circuit, electrical resonance of a circuit involving an output capacitor (C2) and a short circuit inductor generates a negative voltage and may damage the device or the load devices. Connecting a schottky diode (D1) between the VOUT pin and GND has the effect of preventing damage to them.

Input Transient/Load Transient vs. Output Capacity (C2)

R5112 performs a stable operation by using 0.1 μF of ceramic capacitor as the output capacitor. However, the variation of output voltage may not meet the demand of the system when input voltage and load current vary. In such cases, the variation of output voltage can be minimized significantly by using 10 μF or higher ceramic capacitor. When using a high-capacity electrolytic capacitor for the output line, place the electrolytic capacitor a few centimeters apart from the IC after arranging the ceramic capacitor close to the IC.

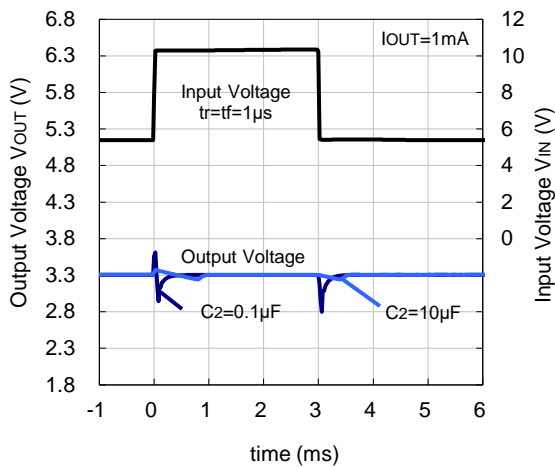
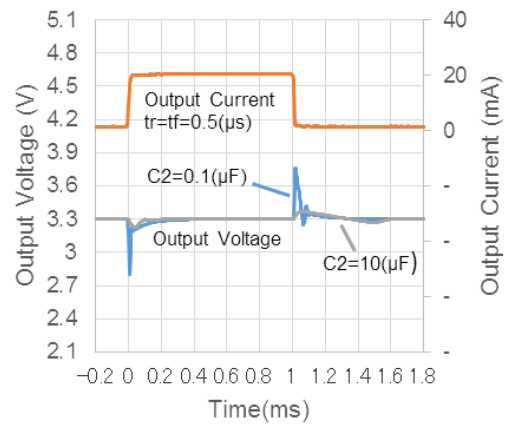
Input Transient Response ($V_{\text{SET}} = 3.3 \text{ V}$)Load Transient Response ($V_{\text{SET}} = 3.3 \text{ V}$)

ESR vs. OUTPUT CURRENT

It is recommended that a ceramic type capacitor be used for this device. However, other types of capacitors having lower ESR can also be used. The relation between the output current (I_{OUT}) and the ESR of output capacitor is shown below.

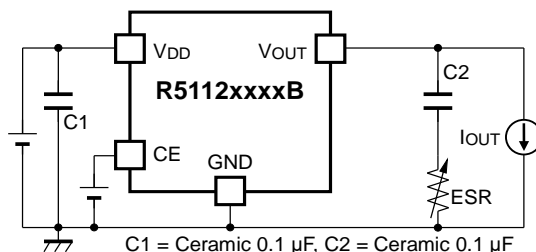

Measurement Conditions

Frequency Band: 10 Hz to 2 MHz

Measurement Temperature: -40°C to 125°C

Hatched Area: Noise level is 40 μV (average) or below

Ceramic Capacitors: C1 = 0.1 μF, C2 = 0.1 μF

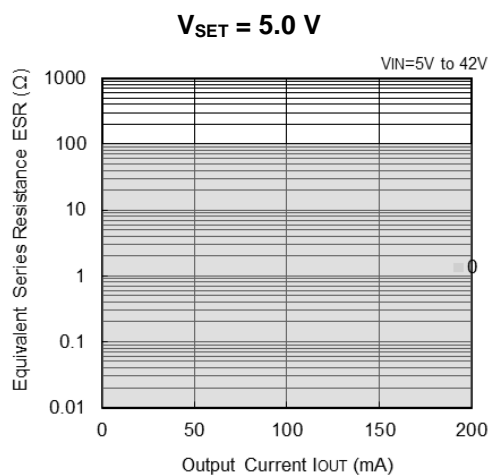
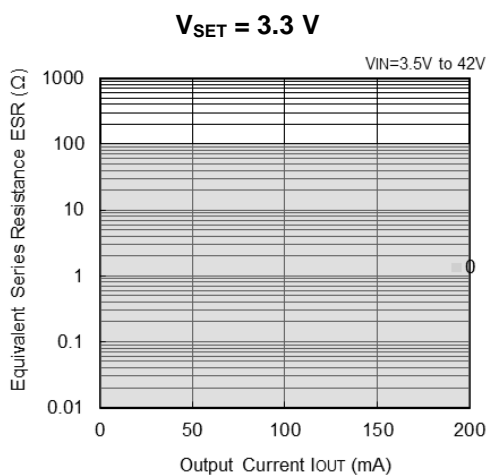
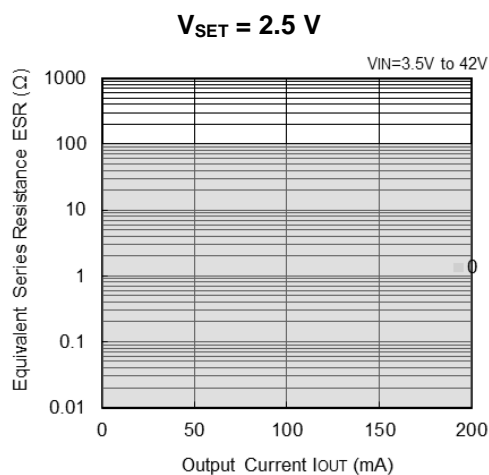
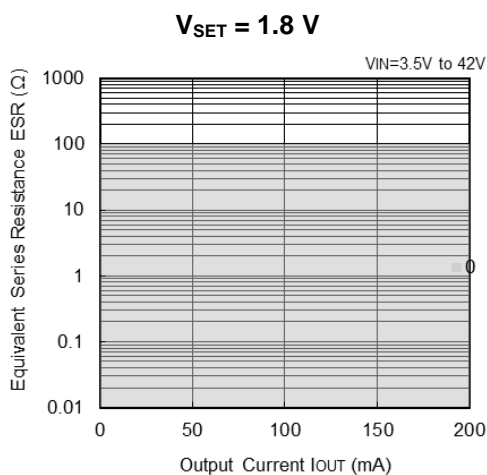

TECHNICAL NOTES

Phase Compensation

In the R5112S, phase compensation is provided to secure stable operation even when the load current is varied. For this purpose, be sure to use 0.1 μF or more of a capacitor (C2).

In case of using a tantalum type capacitor and the ESR (Equivalent Series Resistance) value of the capacitor is large, the output might be unstable. Evaluate the circuit including consideration of frequency characteristics.

PCB Layout

Ensure the VDD and GND lines are sufficiently robust. If their impedance is too high, noise pickup or unstable operation may result. Connect 0.1 μF or more of the capacitor C1 between the VDD and GND, and as close as possible to the pins. In addition, connect the capacitor C2 between VOUT and GND, and as close as possible to the pins.

Prohibited Area of the Input Voltage Variation

When the input voltage is steeply changed in the following prohibited area, the device may fail to detect or fail to release.

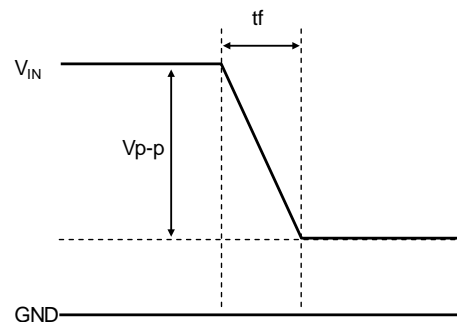
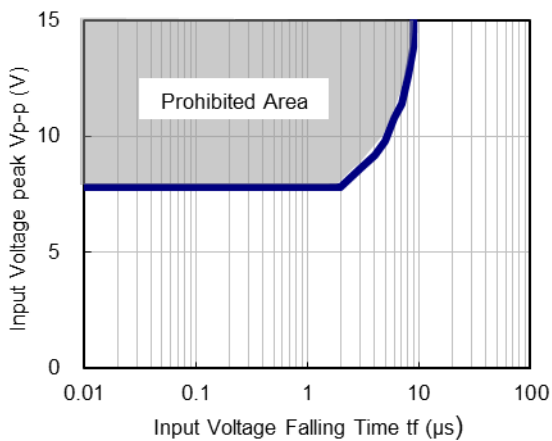

Variation Prohibited Area at Input Voltage (V_{IN}) Falling

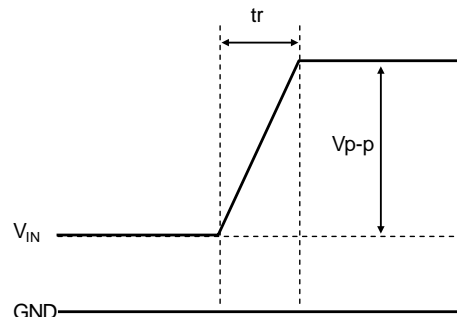
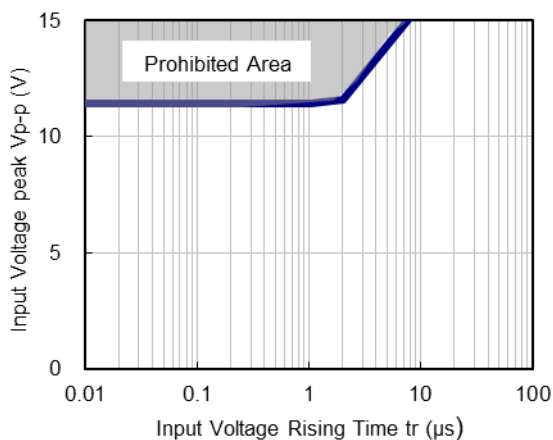

Variation Prohibited Area at Input Voltage (V_{IN}) Rising

TYPICAL CHARACTERISTICS

Note: Typical Characteristics are intended to be used as reference data; they are not guaranteed.

1) Output Voltage vs. Output Current (Ta = 25°C)

V_{SET} = 1.8 V

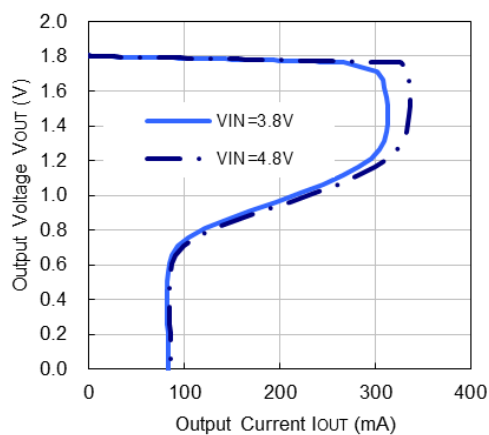

V_{SET} = 2.5 V

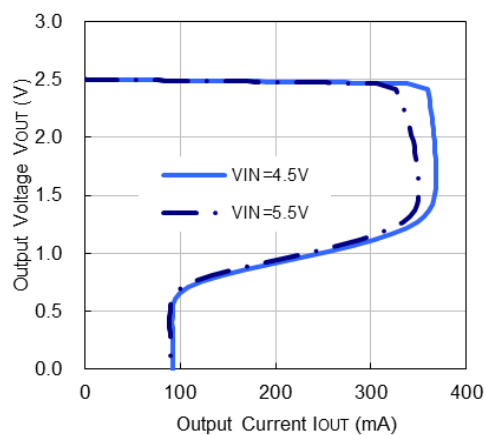

V_{SET} = 3.3 V

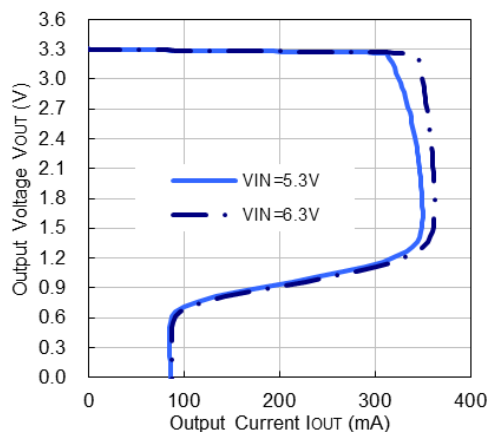

V_{SET} = 5.0 V

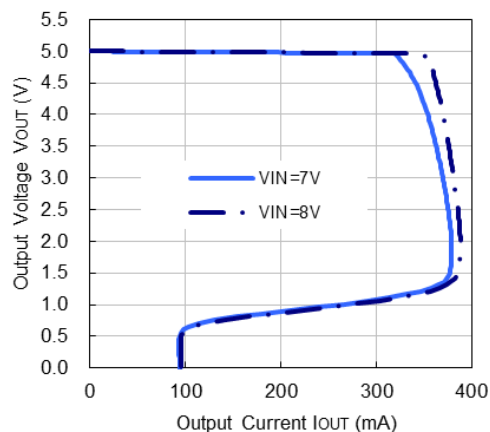

2) Output Voltage vs. Input Voltage (Ta = 25°C)

V_{SET} = 1.8 V

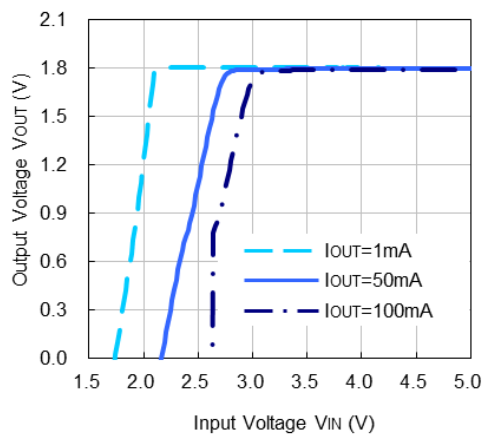

V_{SET} = 2.5 V

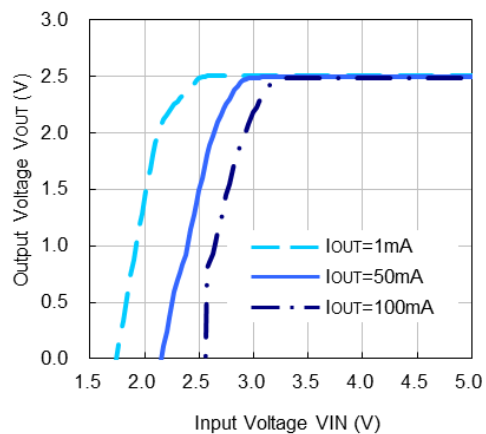

$V_{SET} = 3.3\text{ V}$

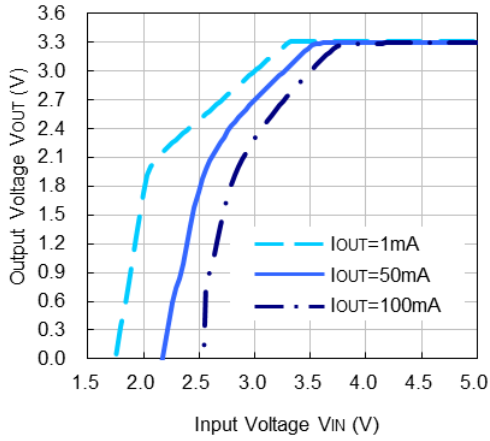

$V_{SET} = 5.0\text{ V}$

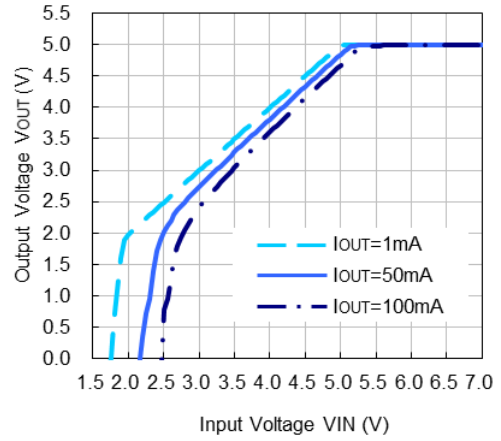

3) Supply Current vs. Temperature

$V_{SET} = 1.8\text{ V}$

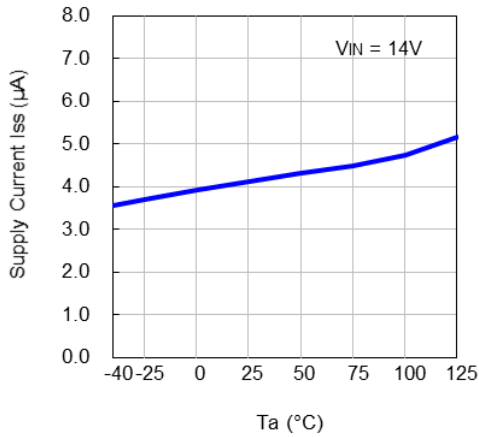

$V_{SET} = 2.5\text{ V}$

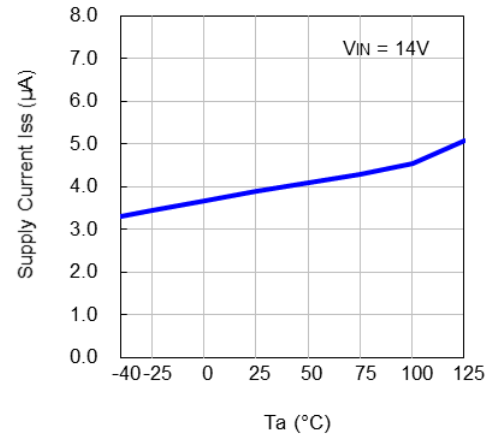

$V_{SET} = 3.3\text{ V}$

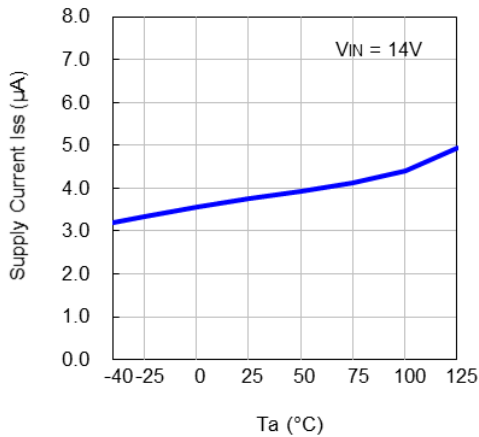

$V_{SET} = 5.0\text{ V}$

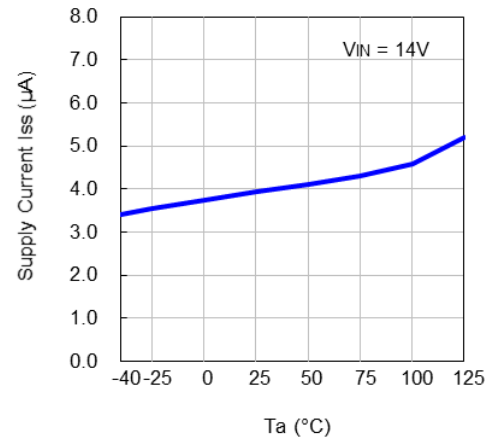

4) Supply Current vs. Input Voltage

$V_{SET} = 1.8\text{ V}$

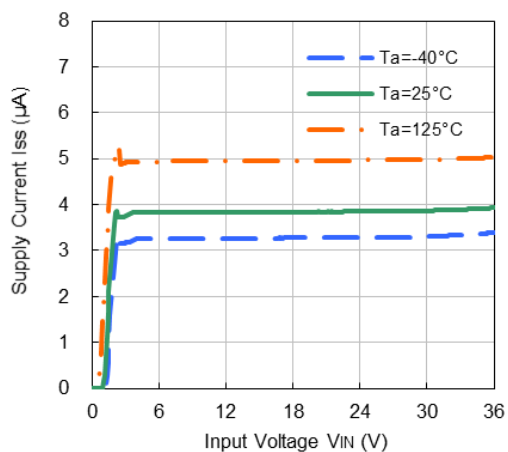

$V_{SET} = 2.5\text{ V}$

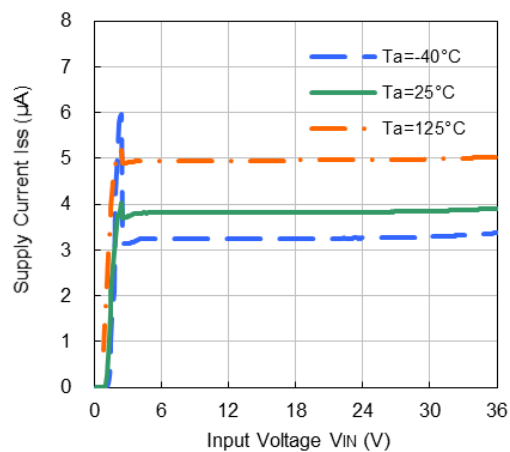

$V_{SET} = 3.3\text{ V}$

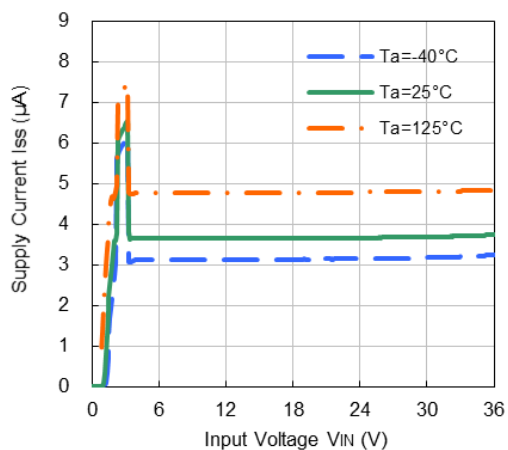

$V_{SET} = 5.0\text{ V}$

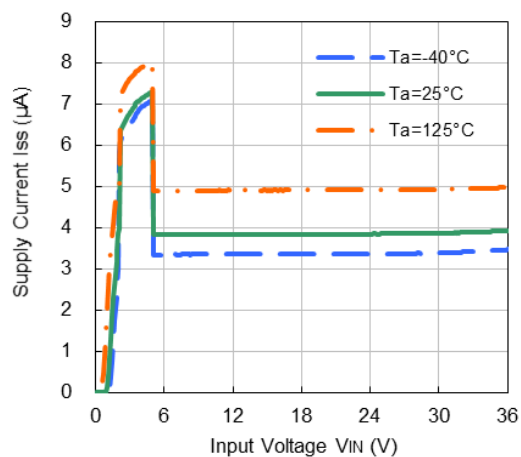

5) Output Voltage vs. Temperature

$V_{SET} = 1.8\text{ V}$

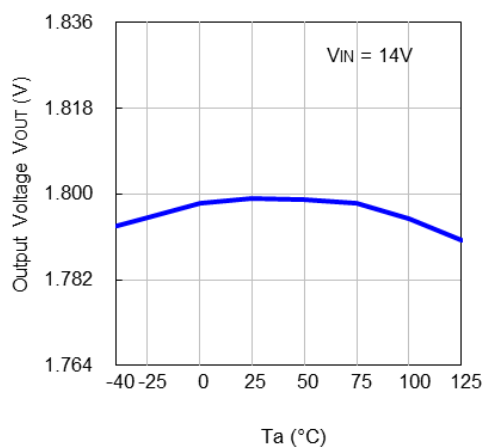

$V_{SET} = 2.5\text{ V}$

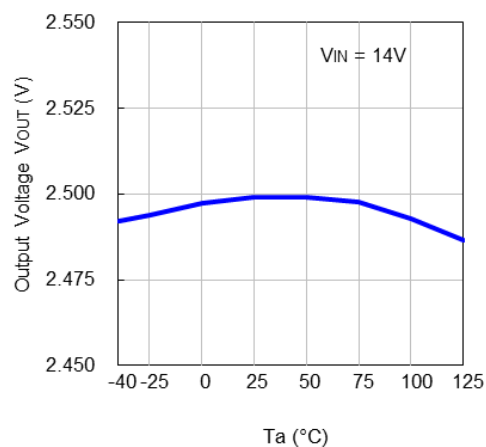

$V_{SET} = 3.3\text{ V}$

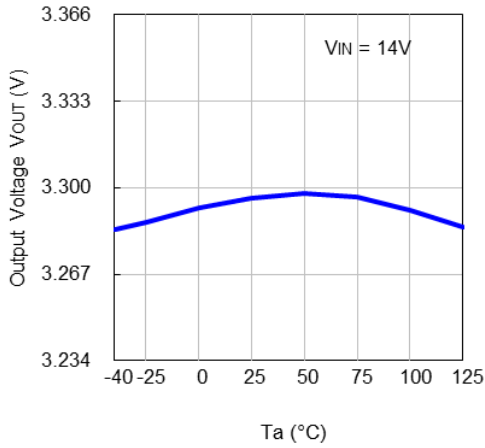

$V_{SET} = 5.0\text{ V}$

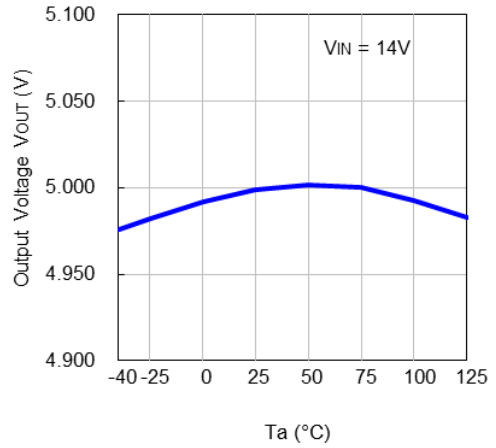

6) Dropout Voltage vs. Output Current

$V_{SET} = 1.8\text{ V}$

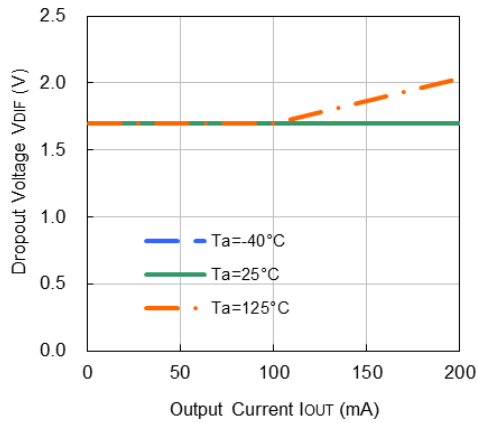

$V_{SET} = 2.5\text{ V}$

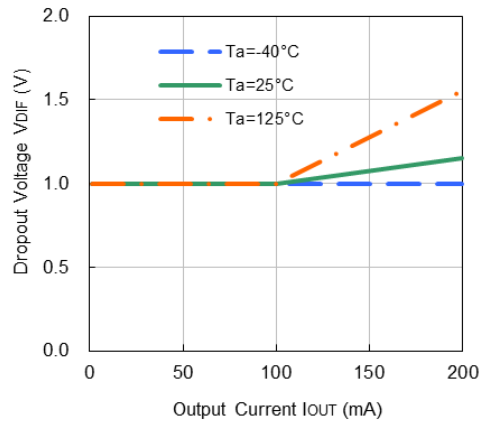

$V_{SET} = 3.3\text{ V}$

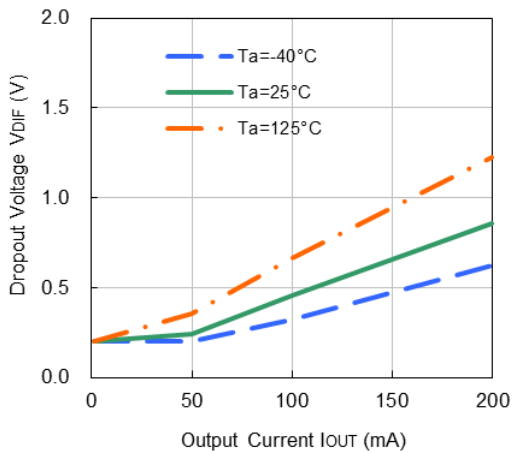

$V_{SET} = 5.0\text{ V}$

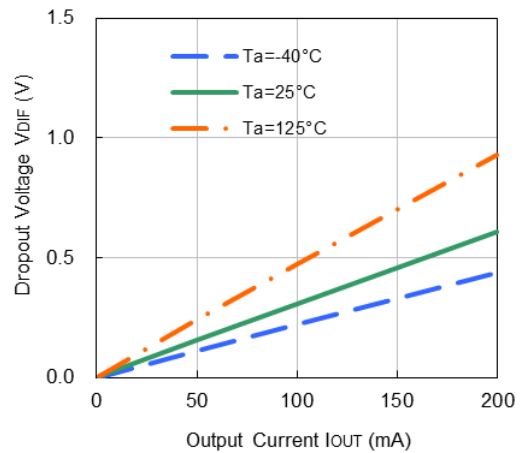

7) Dropout Voltage vs. Output Voltage (Ta = 25°C)

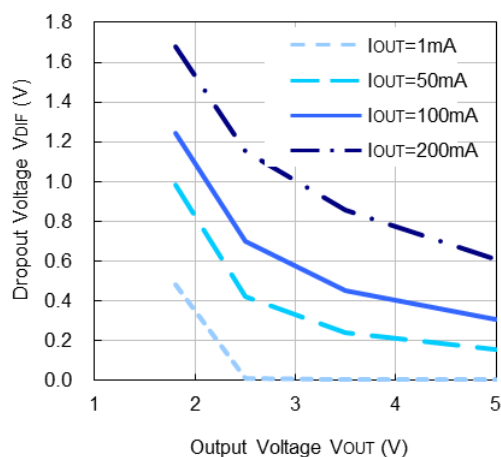

8) Ripple Rejection vs. Input Voltage (Ta = 25°C, Ripple = 0.2 Vpp)

V_{SET} = 1.8 V

V_{SET} = 2.5 V

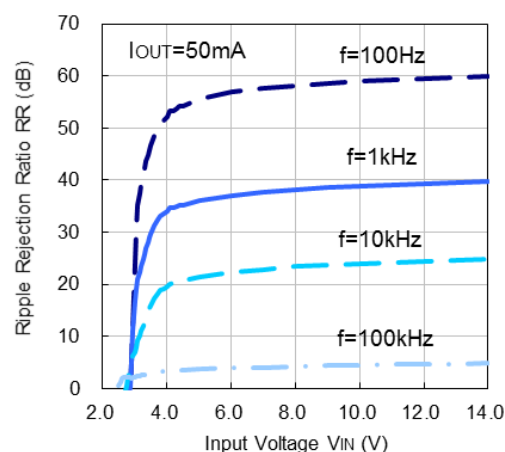
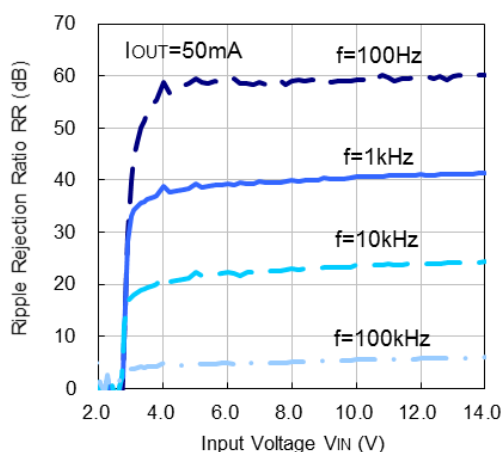

V_{SET} = 3.3 V

V_{SET} = 5.0 V

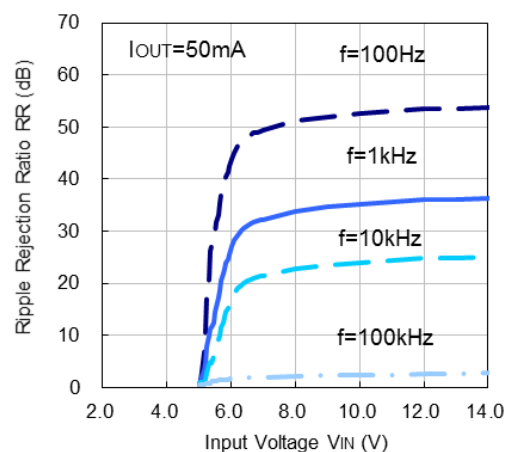
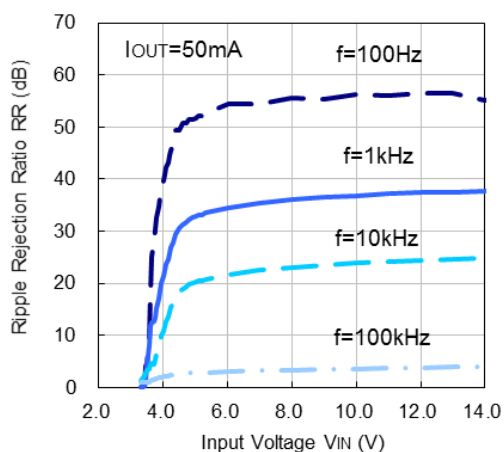

9) Ripple Rejection vs. Frequency (Ta = 25°C, Ripple = 0.2 Vpp)

V_{SET} = 1.8 V

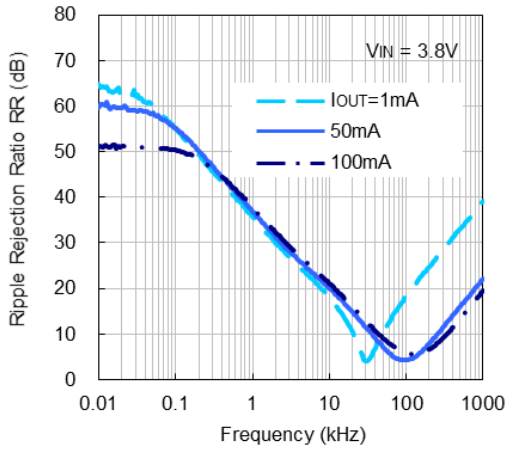

V_{SET} = 2.5 V

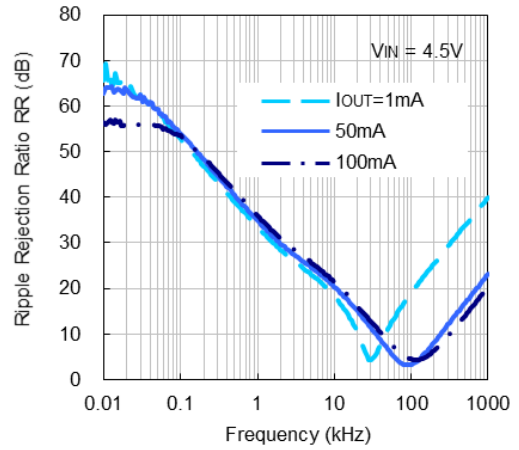

V_{SET} = 3.3 V

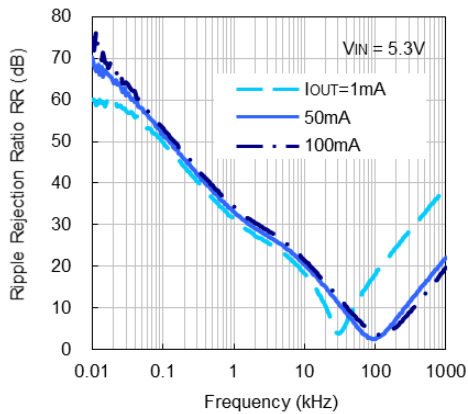

V_{SET} = 5.0 V

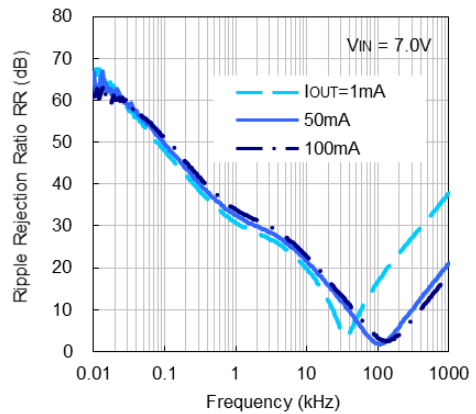

10) Input Transient Response (Ta = 25°C)

V_{SET} = 1.8 V

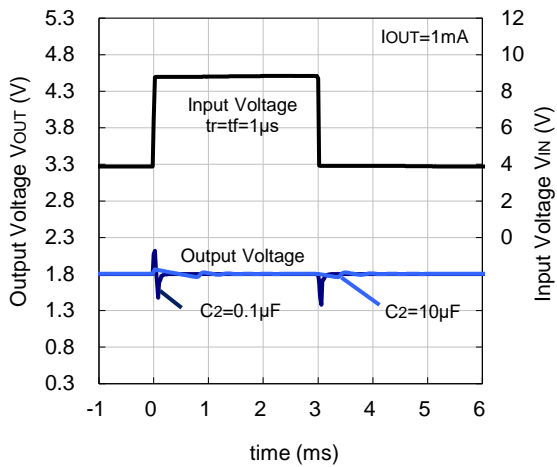

V_{SET} = 2.5 V

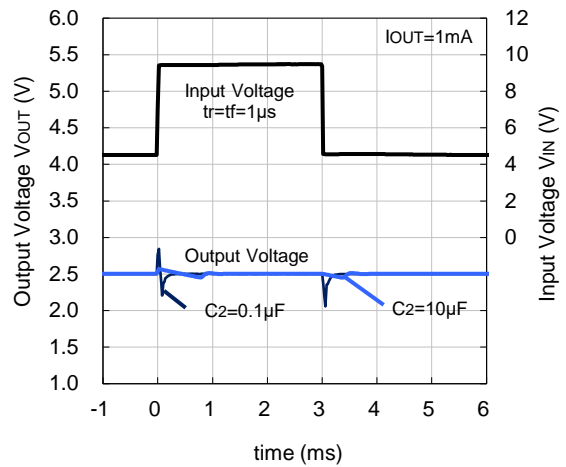

$V_{SET} = 3.3\text{ V}$

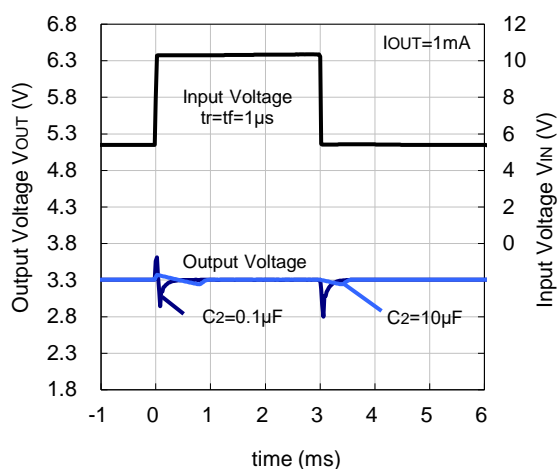

$V_{SET} = 5.0\text{ V}$

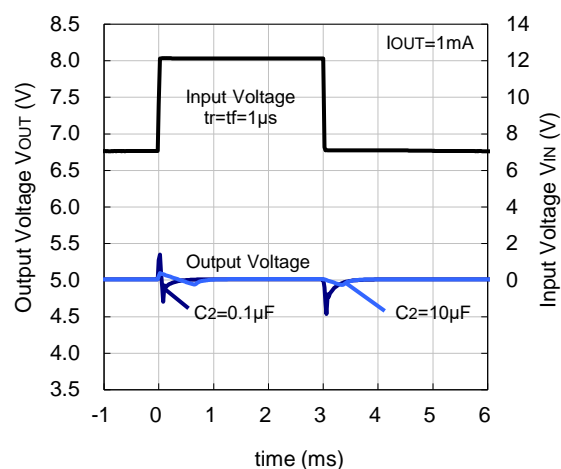

11) Load Transient Response ($T_a = 25^\circ\text{C}$)

$V_{SET} = 1.8\text{ V}$

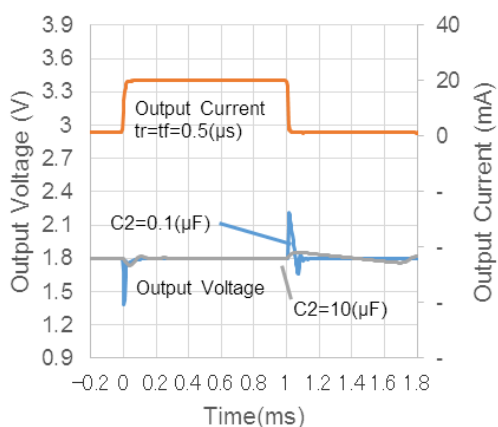

$V_{SET} = 2.5\text{ V}$

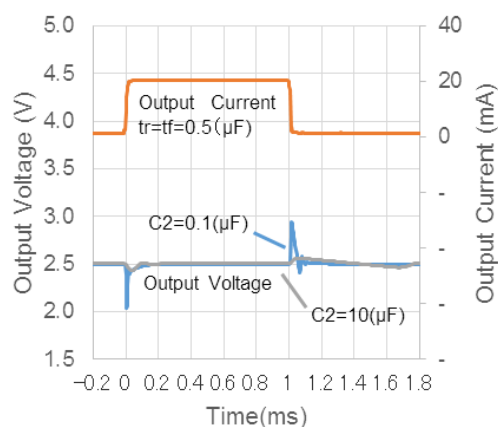

$V_{SET} = 3.3\text{ V}$

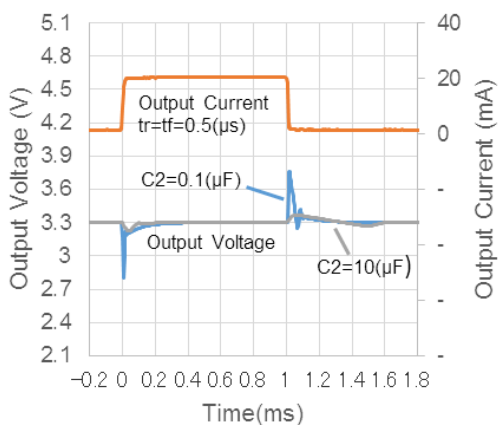

$V_{SET} = 5.0\text{ V}$

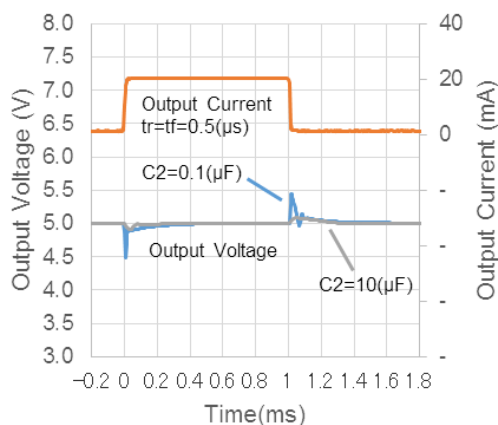

R5112S

No. EC-376-190708

12) CE Transient Response ($T_a = 25^\circ\text{C}$)

$V_{\text{SET}} = 1.8\text{ V}$

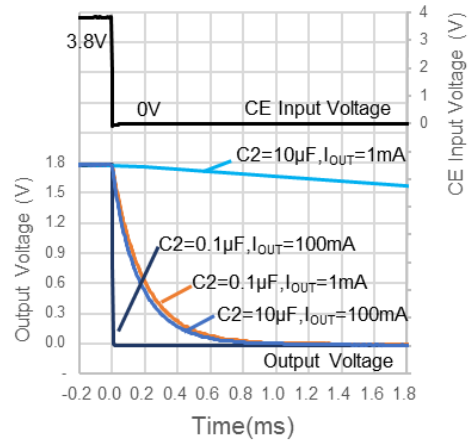
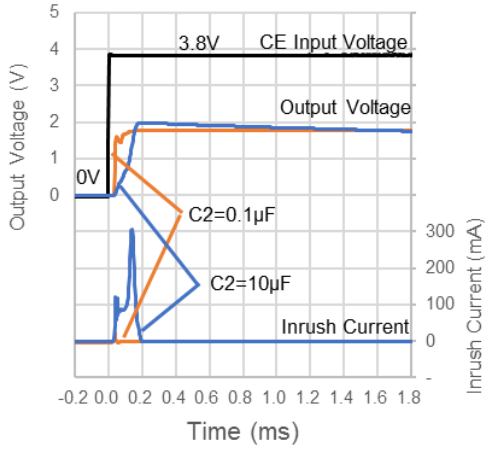

$V_{\text{SET}} = 2.5\text{ V}$

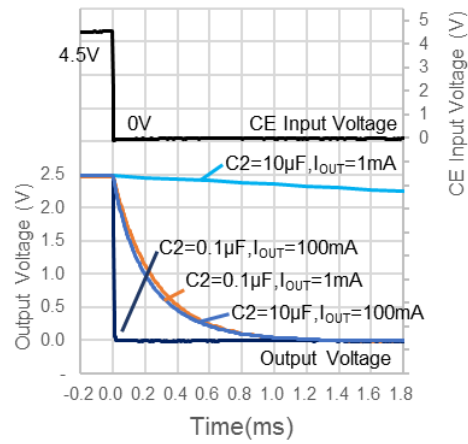
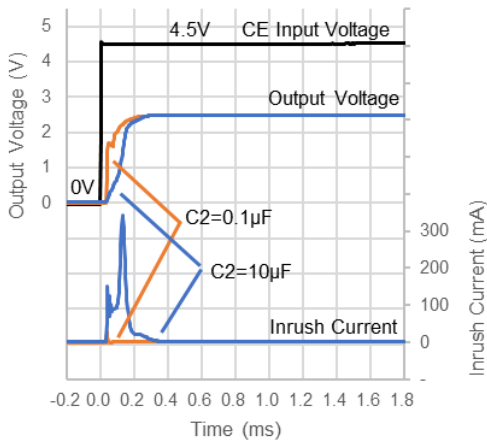

$V_{\text{SET}} = 3.3\text{ V}$

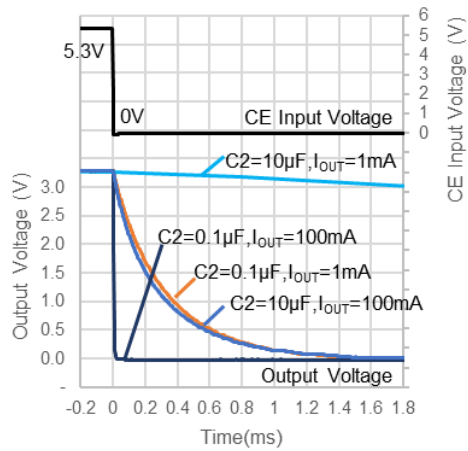
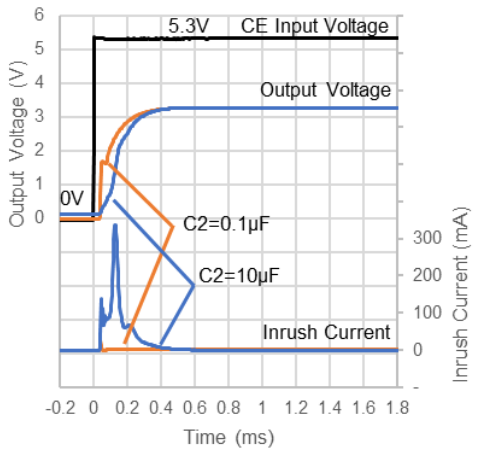

$V_{SET} = 5.0\text{ V}$

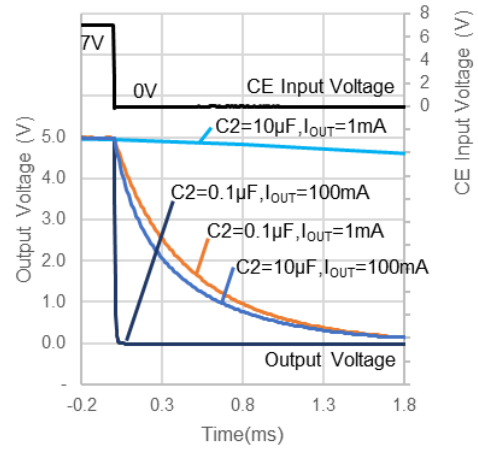
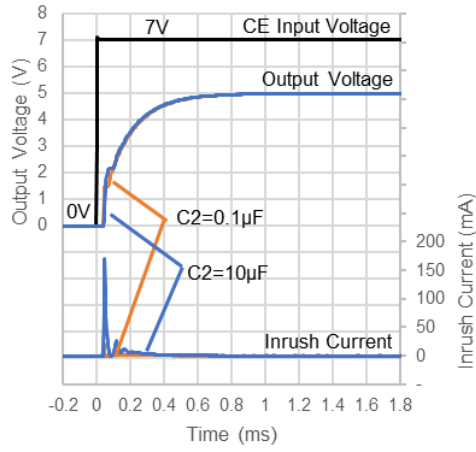

13) Power-on Transient Response (Ta = 25°C)

V_{SET} = 1.8 V

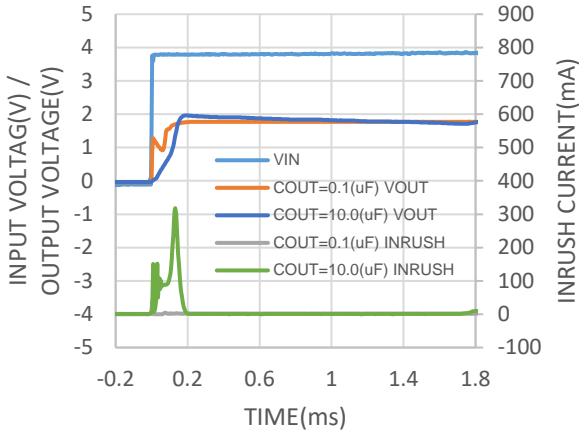

V_{SET} = 2.5 V

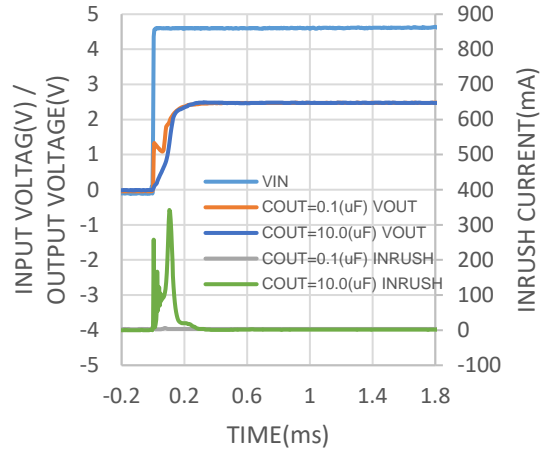

V_{SET} = 3.3 V

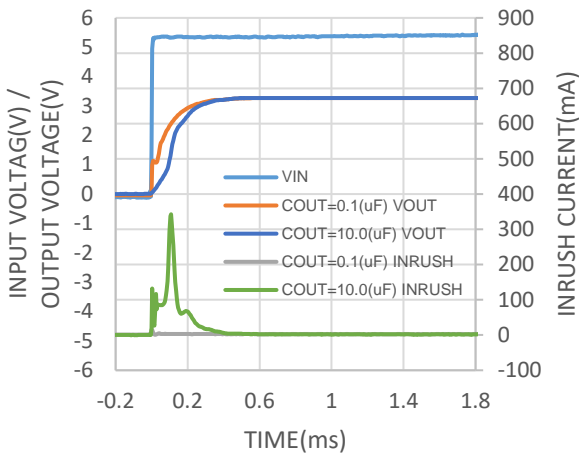

V_{SET} = 5.0 V

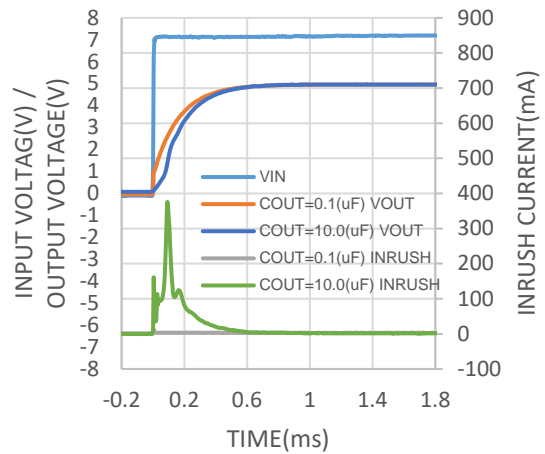

14) Load Dump (Ta = 25°C)

V_{SET} = 1.8 V

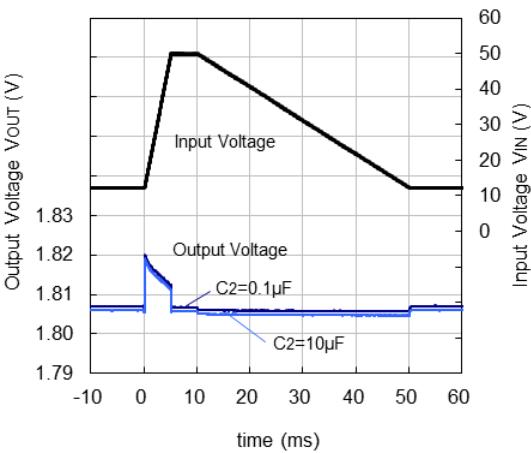

V_{SET} = 2.5 V

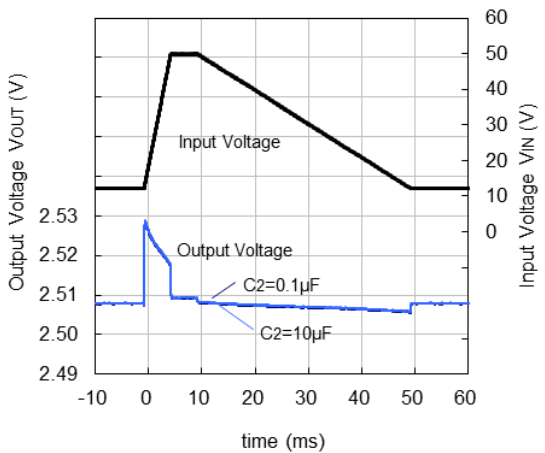

V_{SET} = 3.3 V

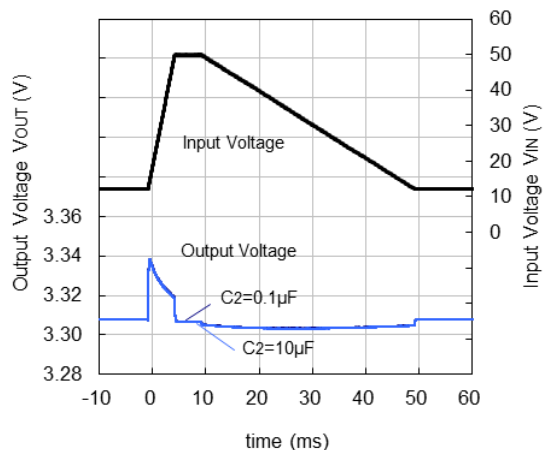

V_{SET} = 5.0 V

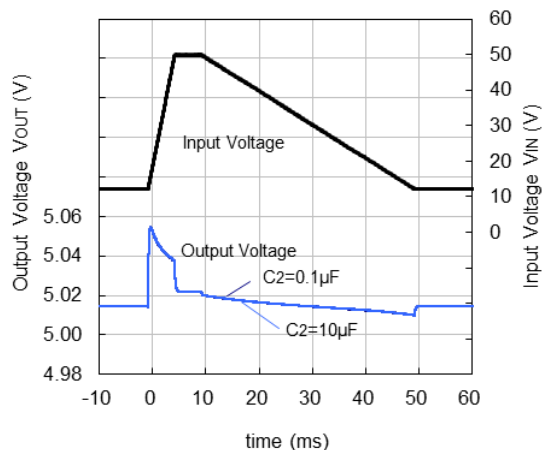

15) Cranking (Ta = 25°C)

V_{SET} = 5.0 V

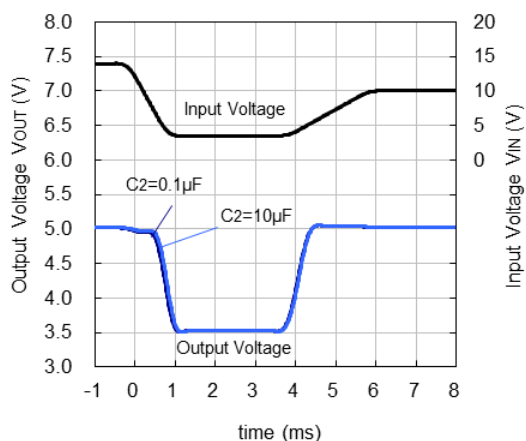

16) Detect/Release Delay Time vs. Temperature

Detect Output Delay Time

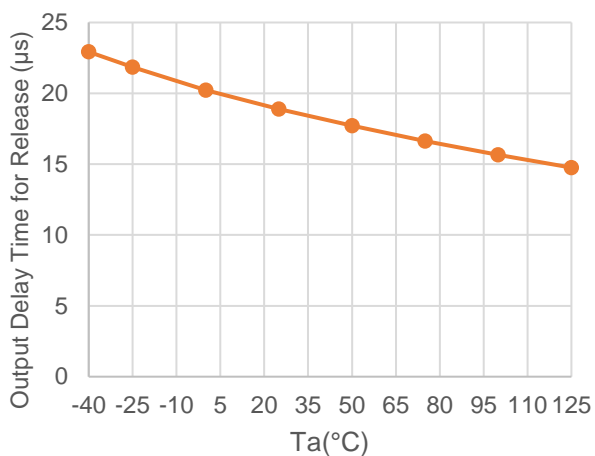

Release Output Delay Time

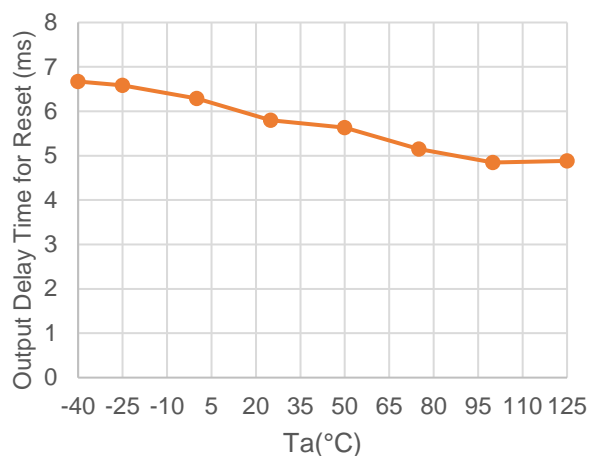

17) Detect/Release Delay Time vs. Input Voltage

Detect Output Delay Time

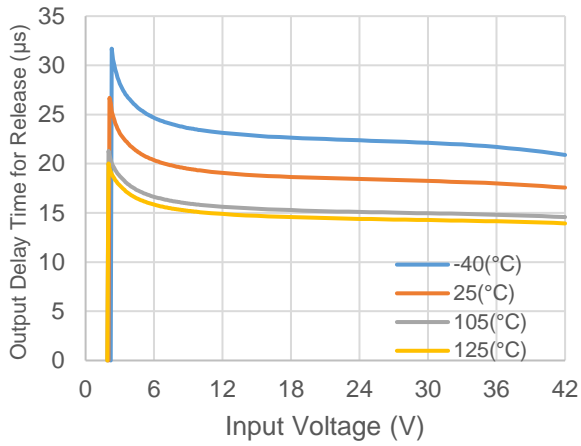

Release Output Delay Time

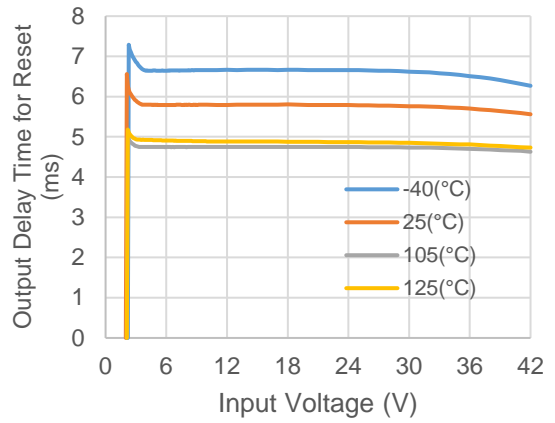

18) Detect (Release) Delay Time vs. External Capacitance for CD Pin (Ta = 25°C)

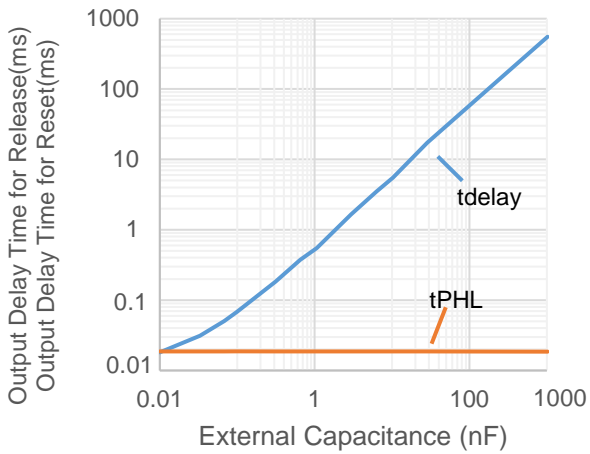

19) Pulse Width vs. Overdrive Voltage (Ta = 25°C)

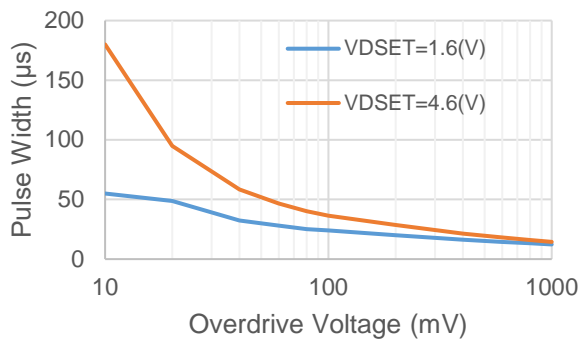

20) D_{OUT} Pin Voltage vs. SENSE Pin Input Voltage (Ta = 25°C)

-V_{SET} = 1.6 V

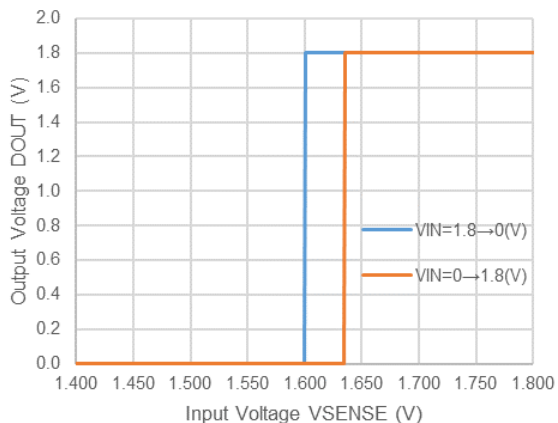

-V_{SET} = 2.2 V

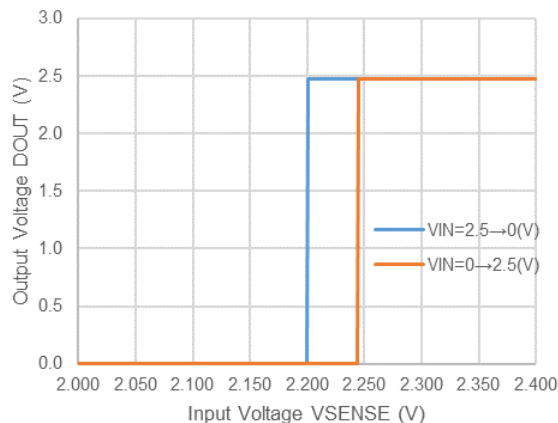

-V_{SET} = 3.0 V

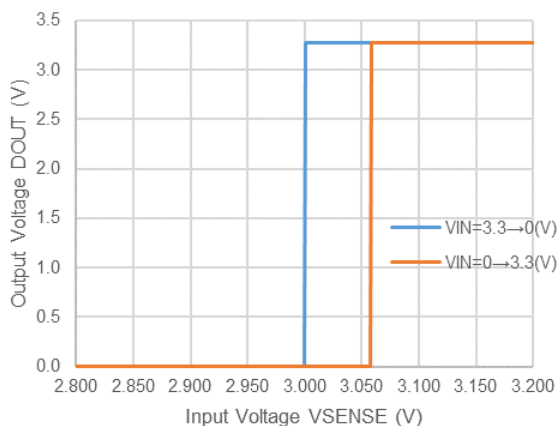

-V_{SET} = 4.6 V

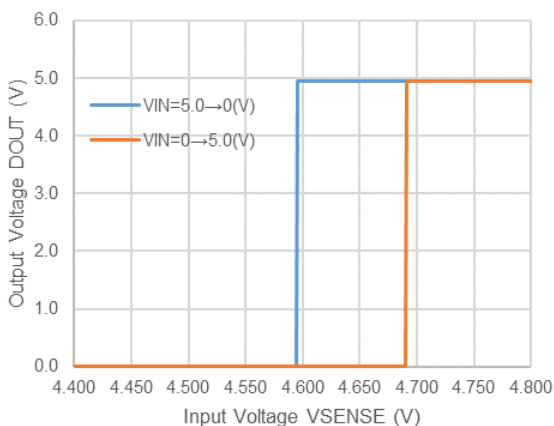

21) C_D Driver Output Current vs. Input Voltage

CE = 5.0 V, SENSE = 5.5 V

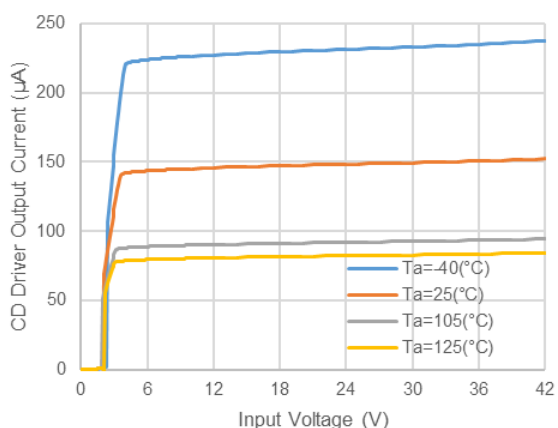

22) Nch Driver Output Current vs. Input Voltage

D_{OUT} = 0.1 V

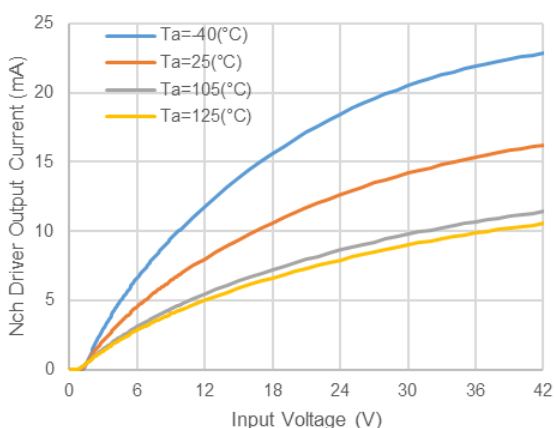

23) D_{OUT} Pin Voltage vs. Input Voltage (V_{OUT} Detection) (Ta = 25°C)

-V_{SET} = 1.6 V

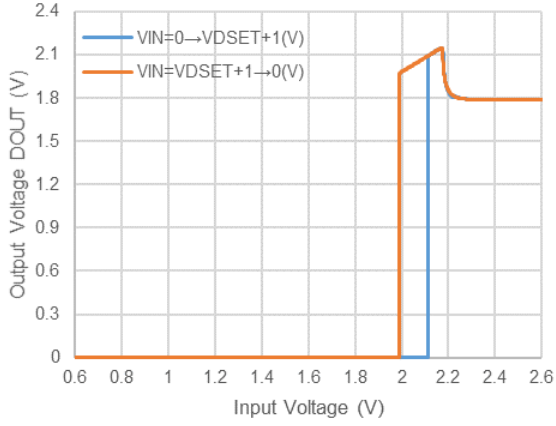

-V_{SET} = 2.2 V

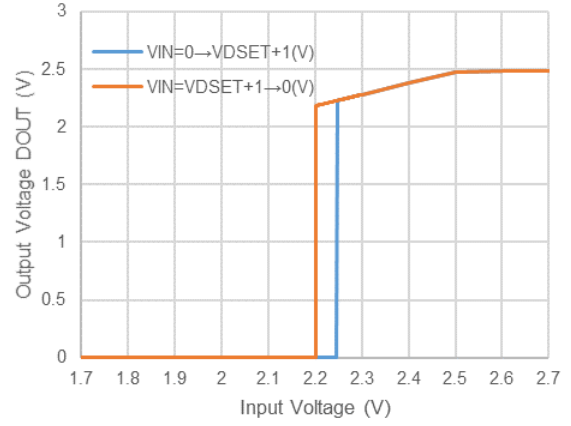

-V_{SET} = 3.0 V

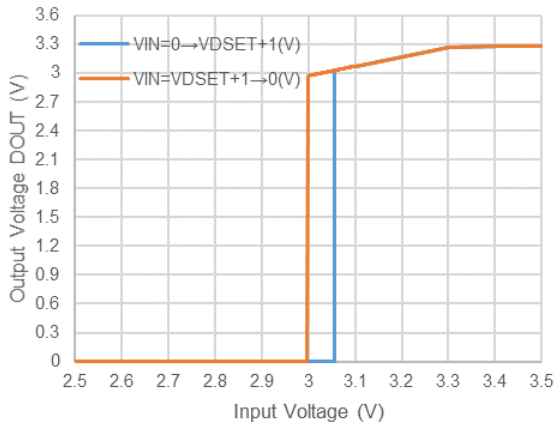

-V_{SET} = 4.6 V

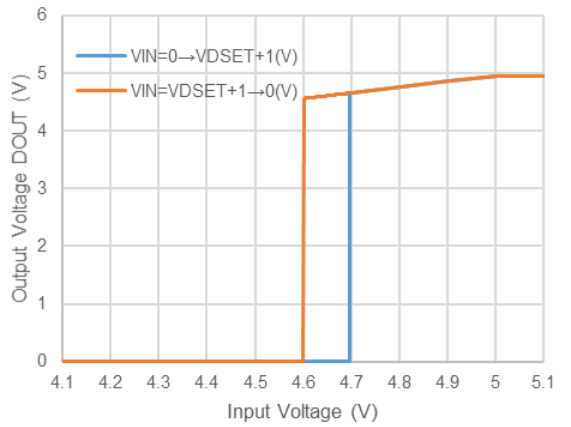

The power dissipation of the package is dependent on PCB material, layout, and environmental conditions. The following measurement conditions are based on JEDEC STD. 51-7.

Measurement Conditions

Item	Measurement Conditions
Environment	Mounting on Board (Wind Velocity = 0 m/s)
Board Material	Glass Cloth Epoxy Plastic (Four-Layer Board)
Board Dimensions	76.2 mm × 114.3 mm × 0.8 mm
Copper Ratio	Outer Layer (First Layer): Less than 95% of 50 mm Square Inner Layers (Second and Third Layers): Approx. 100% of 50 mm Square Outer Layer (Fourth Layer): Approx. 100% of 50 mm Square
Through-holes	φ 0.3 mm × 21 pcs

Measurement Result

(Ta = 25°C, Tjmax = 150°C)

Item	Measurement Result
Power Dissipation	3600 mW
Thermal Resistance (θja)	θja = 34.5°C/W
Thermal Characterization Parameter (ψjt)	ψjt = 10°C/W

θja: Junction-to-Ambient Thermal Resistance

ψjt: Junction-to-Top Thermal Characterization Parameter

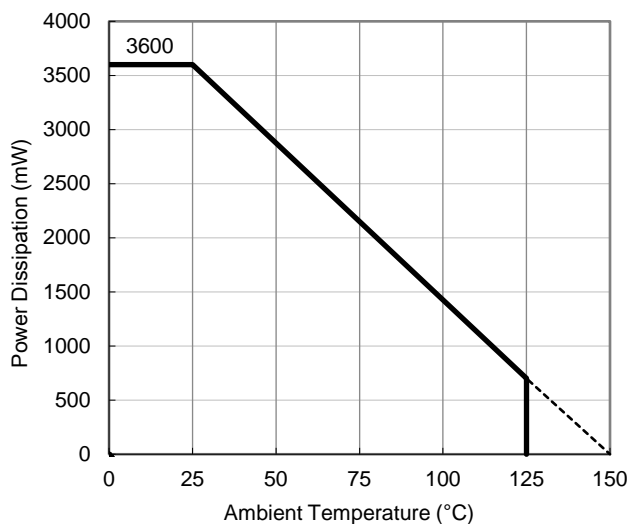

Power Dissipation vs. Ambient Temperature

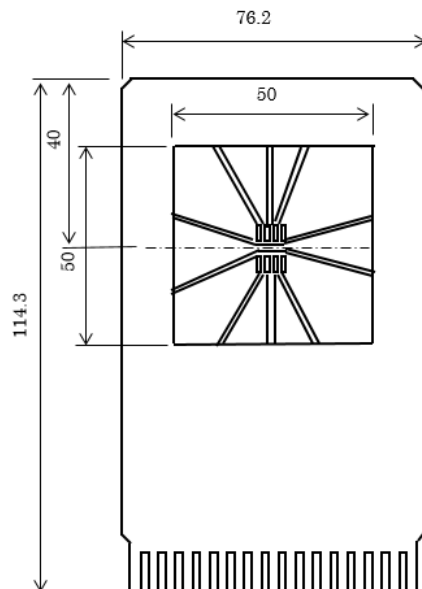

Measurement Board Pattern

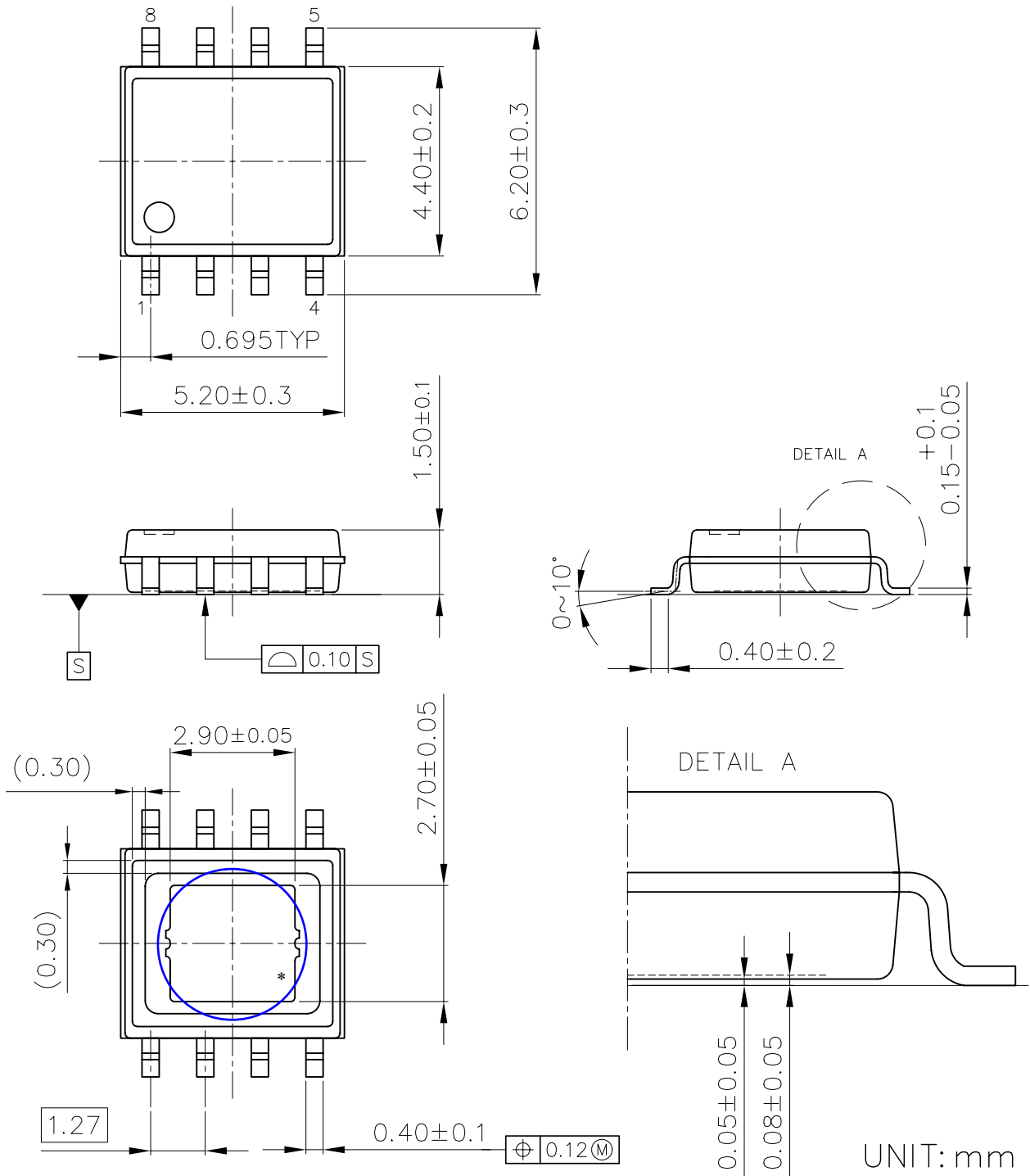

HSOP-8E Package Dimensions

* The tab on the bottom of the package shown by blue circle is substrate potential (GND). It is recommended that this tab be connected to the ground plane on the board but it is possible to leave the tab floating.



1. The products and the product specifications described in this document are subject to change or discontinuation of production without notice for reasons such as improvement. Therefore, before deciding to use the products, please refer to Ricoh sales representatives for the latest information thereon.
2. The materials in this document may not be copied or otherwise reproduced in whole or in part without prior written consent of Ricoh.
3. Please be sure to take any necessary formalities under relevant laws or regulations before exporting or otherwise taking out of your country the products or the technical information described herein.
4. The technical information described in this document shows typical characteristics of and example application circuits for the products. The release of such information is not to be construed as a warranty of or a grant of license under Ricoh's or any third party's intellectual property rights or any other rights.
5. The products in this document are designed for automotive applications. However, when using the products for automotive applications, please make sure to contact Ricoh sales representative in advance due to confirming the quality level.
6. We are making our continuous effort to improve the quality and reliability of our products, but semiconductor products are likely to fail with certain probability. In order to prevent any injury to persons or damages to property resulting from such failure, customers should be careful enough to incorporate safety measures in their design, such as redundancy feature, fire containment feature and fail-safe feature. We do not assume any liability or responsibility for any loss or damage arising from misuse or inappropriate use of the products.
7. Anti-radiation design is not implemented in the products described in this document.
8. The X-ray exposure can influence functions and characteristics of the products. Confirm the product functions and characteristics in the evaluation stage.
9. WLCSP products should be used in light shielded environments. The light exposure can influence functions and characteristics of the products under operation or storage.
10. There can be variation in the marking when different AOI (Automated Optical Inspection) equipment is used. In the case of recognizing the marking characteristic with AOI, please contact Ricoh sales or our distributor before attempting to use AOI.
11. Please contact Ricoh sales representatives should you have any questions or comments concerning the products or the technical information.



Ricoh is committed to reducing the environmental loading materials in electrical devices with a view to contributing to the protection of human health and the environment.

Ricoh has been providing RoHS compliant products since April 1, 2006 and Halogen-free products since April 1, 2012.

RICOH RICOH ELECTRONIC DEVICES CO., LTD.

<https://www.e-devices.ricoh.co.jp/en/>

Sales & Support Offices

Ricoh Electronic Devices Co., Ltd.

Shin-Yokohama Office (International Sales)

2-3, Shin-Yokohama 3-chome, Kohoku-ku, Yokohama-shi, Kanagawa, 222-8530, Japan
Phone: +81-50-3814-7687 Fax: +81-45-474-0074

Ricoh Americas Holdings, Inc.

675 Campbell Technology Parkway, Suite 200 Campbell, CA 95008, U.S.A.
Phone: +1-408-610-3105

Ricoh Europe (Netherlands) B.V.

Semiconductor Support Centre

Prof. W.H. Keesomlaan 1, 1183 DJ Amstelveen, The Netherlands
Phone: +31-20-5474-309

Ricoh International B.V. - German Branch

Semiconductor Sales and Support Centre

Oberrather Strasse 6, 40472 Düsseldorf, Germany
Phone: +49-211-6546-0

Ricoh Electronic Devices Korea Co., Ltd.

3F, Haesung Bldg, 504, Teheran-ro, Gangnam-gu, Seoul, 135-725, Korea
Phone: +82-2-2135-5700 Fax: +82-2-2051-5713

Ricoh Electronic Devices Shanghai Co., Ltd.

Room 403, No.2 Building, No.690 Bibo Road, Pu Dong New District, Shanghai 201203,
People's Republic of China
Phone: +86-21-5027-3200 Fax: +86-21-5027-3299

Ricoh Electronic Devices Shanghai Co., Ltd. Shenzhen Branch

1205, Block D (Jinlong Building), Kingkey 100, Hongbao Road, Luohu District,
Shenzhen, China
Phone: +86-755-8348-7600 Ext 225

Ricoh Electronic Devices Co., Ltd.

Taipei office

Room 109, 10F-1, No.51, Hengyang Rd., Taipei City, Taiwan
Phone: +886-2-2313-1621/1622 Fax: +886-2-2313-1623

Mouser Electronics

Authorized Distributor

Click to View Pricing, Inventory, Delivery & Lifecycle Information:

[Ricoch Electronics:](#)

[R5112S011B-E2-KE](#) [R5112S011D-E2-KE](#) [R5112S121B-E2-KE](#) [RP122K281D5-TR](#) [R5112S161B-E2-KE](#)

Компания «Океан Электроники» предлагает заключение долгосрочных отношений при поставках импортных электронных компонентов на взаимовыгодных условиях!

Наши преимущества:

- Поставка оригинальных импортных электронных компонентов напрямую с производств Америки, Европы и Азии, а так же с крупнейших складов мира;
- Широкая линейка поставок активных и пассивных импортных электронных компонентов (более 30 млн. наименований);
- Поставка сложных, дефицитных, либо снятых с производства позиций;
- Оперативные сроки поставки под заказ (от 5 рабочих дней);
- Экспресс доставка в любую точку России;
- Помощь Конструкторского Отдела и консультации квалифицированных инженеров;
- Техническая поддержка проекта, помощь в подборе аналогов, поставка прототипов;
- Поставка электронных компонентов под контролем ВП;
- Система менеджмента качества сертифицирована по Международному стандарту ISO 9001;
- При необходимости вся продукция военного и аэрокосмического назначения проходит испытания и сертификацию в лаборатории (по согласованию с заказчиком);
- Поставка специализированных компонентов военного и аэрокосмического уровня качества (Xilinx, Altera, Analog Devices, Intersil, Interpoint, Microsemi, Actel, Aeroflex, Peregrine, VPT, Syfer, Eurofarad, Texas Instruments, MS Kennedy, Miteq, Cobham, E2V, MA-COM, Hittite, Mini-Circuits, General Dynamics и др.);

Компания «Океан Электроники» является официальным дистрибьютором и эксклюзивным представителем в России одного из крупнейших производителей разъемов военного и аэрокосмического назначения «JONHON», а так же официальным дистрибьютором и эксклюзивным представителем в России производителя высокотехнологичных и надежных решений для передачи СВЧ сигналов «FORSTAR».



JONHON

«JONHON» (основан в 1970 г.)

Разъемы специального, военного и аэрокосмического назначения:

(Применяются в военной, авиационной, аэрокосмической, морской, железнодорожной, горно- и нефтедобывающей отраслях промышленности)

«FORSTAR» (основан в 1998 г.)

ВЧ соединители, коаксиальные кабели, кабельные сборки и микроволновые компоненты:

(Применяются в телекоммуникациях гражданского и специального назначения, в средствах связи, РЛС, а так же военной, авиационной и аэрокосмической отраслях промышленности).



Телефон: 8 (812) 309-75-97 (многоканальный)

Факс: 8 (812) 320-03-32

Электронная почта: ocean@oceanchips.ru

Web: <http://oceanchips.ru/>

Адрес: 198099, г. Санкт-Петербург, ул. Калинина, д. 2, корп. 4, лит. А