

Applications

- Automotive
- Instrumentation
- White goods
- Telecommunications

Benefits

- RoHS Compliant
- Halogen and Lead Free
- Sharp detection feeling
- Compact Size

JJ Series – Detector Switches

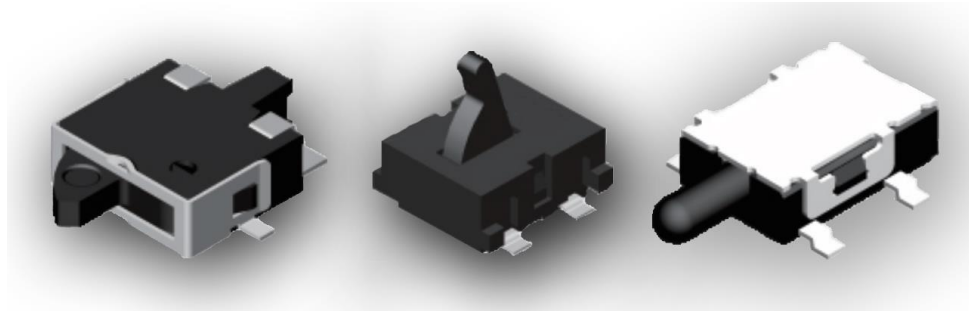

TE Connectivity is pleased to introduce its JJ Series of Detector Switches, suitable for a wide variety of applications given their several presentations ranging from horizontal or vertical actuated options as well as Gull-winged, J-leaded and Through-Hole mounting possibilities.

The Detector Switches will be offered in a wide range of sizes giving the possibility for countless applications going from automotive to telecommunications.

JJ Series – Family Classification

Series	Body Size
JJA	3.5x2.8 mm
JJB	3.5x2.98 mm
JJC	3.5x3.3 mm
JJD	4.2x3.6 mm
JJE	4.7x3.5 mm
JJF	4.7x3.8 mm
JJG	5.7x4.0 mm (High-Rating)
JJH	5.7x4.0 mm (Standard-Rating)
JJI	5.0x4.4 mm
JJJ	6.0x4.85 mm / 5.5x4.7 mm
JJK	6.3x3.0 mm
JJL	6.5x3.9 mm
JJM	5.7x4.0 mm
JJN	5.7x4.0 mm (Wedge)
JJO	10.0x3.8 mm
JJP	10.6x10.0 mm

JJE Family – 4.7x3.5 mm

JJE --- NOH		
	Contact Rating	10mA, 5VDC Max.
	Contact Resistance	1Ω Max.
	Insulation Resistance	100MΩ Min.
	Dielectric Strength	100VAC/1 minute
	Operating Force	36gF Max.
	Travel	2.5mm
	Operating Life	100,000 cycles
	Operating Temperature	-40°C to 85°C
	Storage Temperature	-40°C to 85°C

Features	Applications
<ul style="list-style-type: none"> Guiding post for easy orientation Long travel type 	<ul style="list-style-type: none"> Consumer electronics Medical devices

Circuit

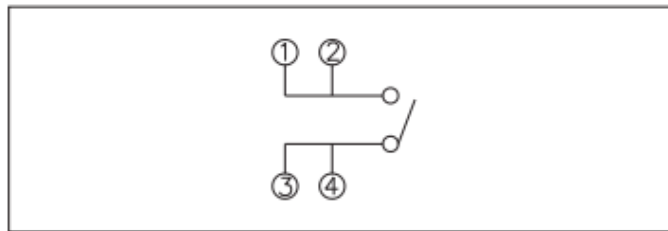

Diagram

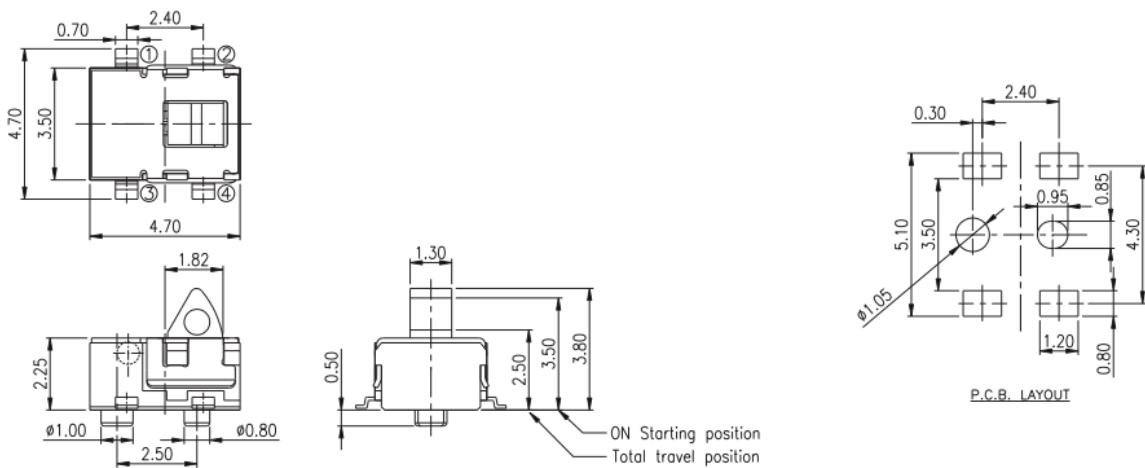

1. Style

“Detector Switches” are mainly used as signal switches of electric devices, with the general requirements of mechanical and electrical characteristic.

1.1 Operating Temperature Range: -40°C to 85°C

1.2 Storage Temperature Range: -40°C to 85°C

1.3 The shelf life of product is within 6 months.

2. Current Range: 10mA, 5VDC Max.

3. Type of Actuation: Momentary

4. Test Sequence:

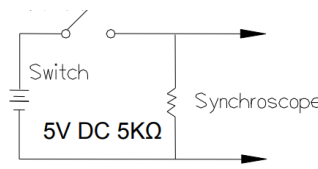
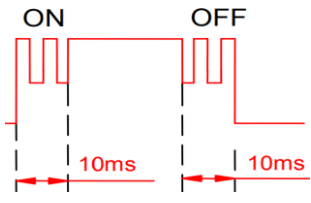
	Item	Description	Test Conditions	Requirements
Appearance	1	Visual Examination	Physical inspection without applying any external forces.	There shall be no defects that affect the serviceability of the product.
Electric Performance	2	Contact Resistance	Actuate the switch (2.80) and measure contact resistance using a micro-Ohmmeter.	1Ω Max.
	3	Insulation Resistance	Measurements shall be made at 100 VDC potential between terminals and cover.	100MΩ Min
	4	Dielectric Withstanding Voltage	100 VAC (50Hz or 60Hz) shall be applied across terminals and cover for 1 minute	There shall be no breakdown or flashover
	5	Bounce	3 to 4 operations at a rate of 1 cycles per second Bounce 	10 m seconds Max. 

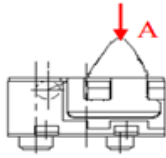
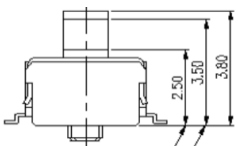
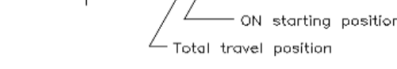
Mechanical Performance	6	Operating Force	As the specification shows operating force is measured 	36gf (0.35N) Max.
	7	Contact (On) point		3.5±0.20mm
	8	Stroke		1.30mm
	9	Stop Strength	Operation direction: 1kg (9.8N) static operation force applies on the center of the actuator for 15 seconds.	As shown in items 2 through 7.
	10	Solder Heat Resistance	(See chart below)	Shall be free from pronounced backlash and falling-off or breakage terminals (As shown in item 2 to7)
	11	Solderability	1) Soldering Temperature : 245±3°C Lead-Free solder : M705E JIS Z 3282 A (Tin 96.5%, Silver 3%, Copper 0.5%) 2) Flux: 5-10 sec. 3) Duration of solder mmersion:5±1sec	No anti-soldering and the coverage of dipping into solder must more than 90% was requested
Durability	12	Operating Life	Tested as follows: 1) 1mA,5 VDC resistive load 2) Applying a static load the operating force to the center of the stem in the direction of operation Static Load = OF Max. 3) Rate of Operation:15~20 operation per minute. 4) Cycle of Operation: 100,000 cycles Min.	1) As shown in item 4 to 5 2) Operating force: ±50% of initial force. 3) Contact Resistance: 10Ω Max 4) Insulation Resistance: 10MΩ Min
Environmental Endurance	13	Vibration	Test per Method IEC 60068-2-6: 1) Swing distance=1.5mm) 2) Frequency: 10-55Hz in 9.81-minute/10cycle. 3) Direction: 3 vertical directions including the directions of operation 4) Test time: 98.1 minute each direction	1) As shown in item 4 to 7 2)Contact Resistance: 10Ω Max 3)Insulation Resistance: 10MΩ Min

Environmental Endurance	14	Shock	Test per Method IEC60068-2-27 1) Acceleration; 50G 2) Action time: 11±1m seconds 3) Testing Direction: 6 sides 4) Test Cycle: 3 times in each direction	1) As shown in item 4 to 7 2) Contact Resistance: 10Ω Max 3) Insulation Resistance: 10MΩ Min
	15	Cold Resistance	Following the test set forth below the sample shall be left in normal temperature and humidity conditions for 1 hour before the measurements are made: 1) Temperature: -40±2°C 2) Time: 96hours	1) As shown in item 4 to 7 2) Contact Resistance: 10Ω Max 3) Insulation Resistance: 10MΩ Min
	16	Heat Resistance	Following the test set forth below the sample shall be left in normal temperature and humidity conditions for 1 hour before the measurements are made: 1) Temperature: 85±2°C 2) Time: 96 hours	1) As shown in item 4 to 7 2) Contact Resistance: 10Ω Max 3) Insulation Resistance: 10MΩ Min
	17	Humidity Resistance	Following the test set forth below the sample shall be left in normal temperature and humidity conditions for 1 hour before the measurements are made: 1) Temperature: 40±2°C 2) Relative Humidity: 90 to 95% 3) Time: 96 hours	1) As shown in item 4 to 7 2) Contact Resistance: 10Ω Max 3) Insulation Resistance: 10MΩ Min

5. Soldering Conditions:

■ Recommended Soldering Profile for the JJE Series

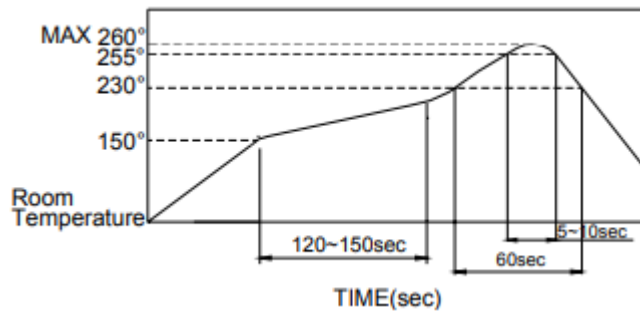

■ The condition mentioned above is the temperature on the Cu foil of the PCB surface. There are cases where board's temperature greatly differs from switch's surface be used not to allow switch's surface temperature to exceed 260°C.

■ Manual Soldering

Soldering Temperature: 350°C Max.

Continuous Soldering Time: 5 second Max.

■ Precautions in Handling

1. Care must be taken to ensure excess flux on the top surface of the printed circuit board does not adhere to the switch.
2. Do not wash the switch.

■ Recommended storage conditions:

Store the products in the original packaging material. After opening the package, the remaining products must be stored in the appropriate moisture-proof & airtight environment.

Do not store the switch in the following environment or it may affect performance and solderability:

1. temperatures below -10° C to 40°C & humidity at 85% (min)
2. environment with corrosive gas
3. storage over 6 months
4. place in direct sunlight

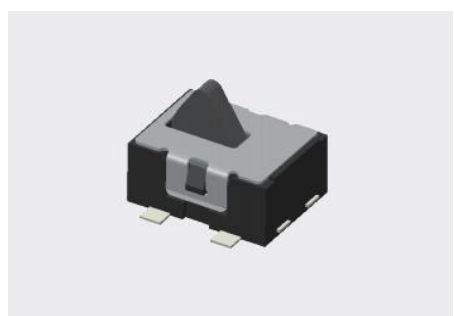
JJE --- NO		
	Contact Rating	1mA, 5VDC Max.
	Contact Resistance	1Ω Max.
	Insulation Resistance	50MΩ Min.
	Dielectric Strength	250VAC/1 minute
	Operating Force	60gF Max.
	Travel	2.5mm
	Operating Life	100,000 cycles
	Operating Temperature	-40°C to 85°C
	Storage Temperature	-40°C to 85°C

Circuit

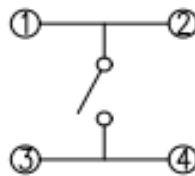

Diagrams

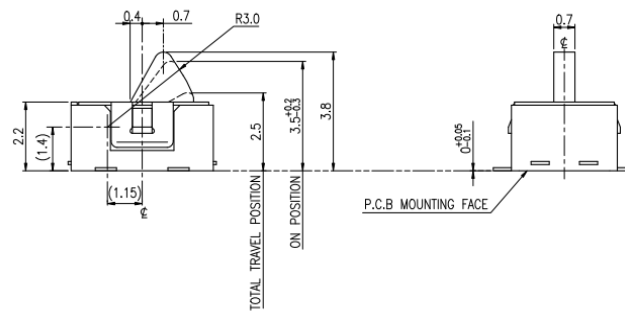
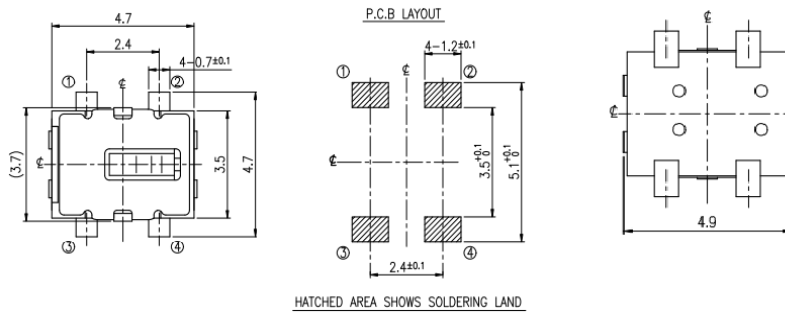



1. Style

“Detector Switches” are mainly used as signal switches of electric devices, with the general requirements of mechanical and electrical characteristic.

1.1 Operating Temperature Range: -40°C to 85°C

1.2 Storage Temperature Range: -40°C to 85°C

1.3 The shelf life of product is within 6 months.

2. Current Range: 1mA, 5VDC Max.

3. Type of Actuation: Momentary

4. Test Sequence:

	Item	Description	Test Conditions	Requirements
Appearance	1	Visual Examination	Physical inspection without applying any external forces.	There shall be no defects that affect the serviceability of the product.
Electric Performance	2	Contact Resistance	Applying a static load twice the operating force to the measure position of the slider. Shall be measured at 1KHz ± 200Hz (Max. 20mV, Max. 50mA.) or 1A, 5VDC. By voltage drop method.	1Ω Max.
	3	Insulation Resistance	Measurements shall be made at 250 VDC potential between terminals and cover.	50MΩ Min.
	4	Dielectric Withstanding Voltage	Apply 250 VAC (50Hz or 60Hz) between terminals and cover for 1 minute.	There shall be no breakdown or flashover

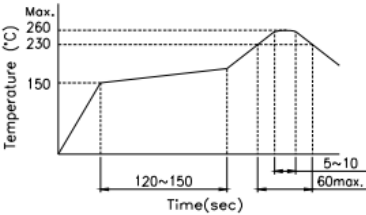
Mechanical Performance	5	Operating Force	Applying force to the center of the stem for 1.60±0.2mm (0.063±.008in.)	50gF Max. (0.49N Max.)
	6	Terminal Strength	A static load of 300gf shall be applied to the tip of terminal in the desired direction for 1 minute. The number of tests shall be once per terminal.	Shall be free from terminal looseness and damage and breakage of terminal Holding portion.
	7	Control Strength	1) A static load of 500gf shall be applied in the operating direction of the slider for 1 minute. 2) A static load of 150gf shall be applied to the slider in the vertical direction of operation for 1 minute.	1) Contact resistance: 10Ω Max. 2) Insulation resistance: 10MΩ Min. 3) Withstand voltage: 250VAC for 1 minute 4) Operating force: within ±30% of initial Value. 5) Appearance: every part should not defect in appearance
	8	Solderability	Switch shall be checked after following test: 1) Soldering temperature: 260±5°C 2) Dipping time: 3±0.5 sec.	More than 90% of Immersed part shall be covered with Solder. Excluding the cutting surface.
	9	Soldering Heat Resistance	Switch shall be measured after following test. 1) Hand soldering temperature: 350°C Max. Time: 3 seconds Max. 2) Reflow soldering: 2 times or less  Above mentions time-temperature Chart is based on the temperature on The parts-mounting surface of PCB.	1) Contact resistance: 10Ω Max. 2) Insulation resistance: 10MΩ Min. 3) Withstand voltage: 250VAC for 1 minute 4) Operating force: within ±30% of initial Value. 5) Appearance: every part should not defect in appearance
Durability	10	Operating Life	Tested as follows: 1) Rate of operation: 15 to 20 operations per minute. 2) Cycle of operation: 100,000 cycles Min.	1) Contact resistance: 10Ω Max. 2) Insulation resistance: 10MΩ Min. 3) Withstand voltage: 250VAC for 1 minute 4) Operating force: within ±30% of initial Value. 5) Appearance: every part should not defect in appearance

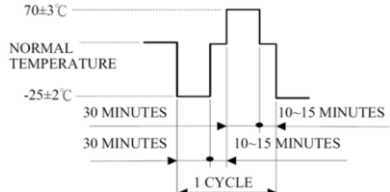
Weather Performance	11	Humidity Resistance	Testing switch being kept in the conditions at $65\pm 2^{\circ}\text{C}$ and 90 to 95% RH for 96 hours, then in a normal ambient condition for 1 hour, then to be measured within 1 hour.	1) Contact resistance: 10Ω Max. 2) Insulation resistance: $10\text{M}\Omega$ Min. 3) Withstand voltage: 250VAC for 1 minute 4) Operating force: within $\pm 30\%$ of initial Value. 5) Appearance: every part should not defect in appearance
	12	Heat Resistance	Testing switch being kept in the Conditions at $80\pm 2^{\circ}\text{C}$ in temperature for 96 hours, then in a normal ambient condition for 1 hour, then to be measured within 1 hour.	
	13	Cold Resistance	Testing switch being kept in the conditions at $-40\pm 2^{\circ}\text{C}$ in temperature for 96 hours, then in a normal ambient condition for 1 hour, then to be measured within 1 hour. Water drops shall be removed.	
	14	Temperature Cycle Test	After 5 cycles of following conditions, the Switch shall be allowed to stand under Normal temperature and humidity conditions for 1 hour, and water drops Shall be removed. 	

■ Precautions in Handling

1. Care must be taken to ensure excess flux on the top surface of the printed circuit board does not adhere to the switch.
2. Do not wash the switch.

■ Recommended storage conditions:

Store the products in the original packaging material. After opening the package, the remaining products must be stored in the appropriate moisture-proof & airtight environment.

Do not store the switch in the following environment or it may affect performance and solderability:

1. temperatures below -10°C to 40°C & humidity at 85% (min)
2. environment with corrosive gas
3. storage over 6 months
4. place in direct sunlight

How to order

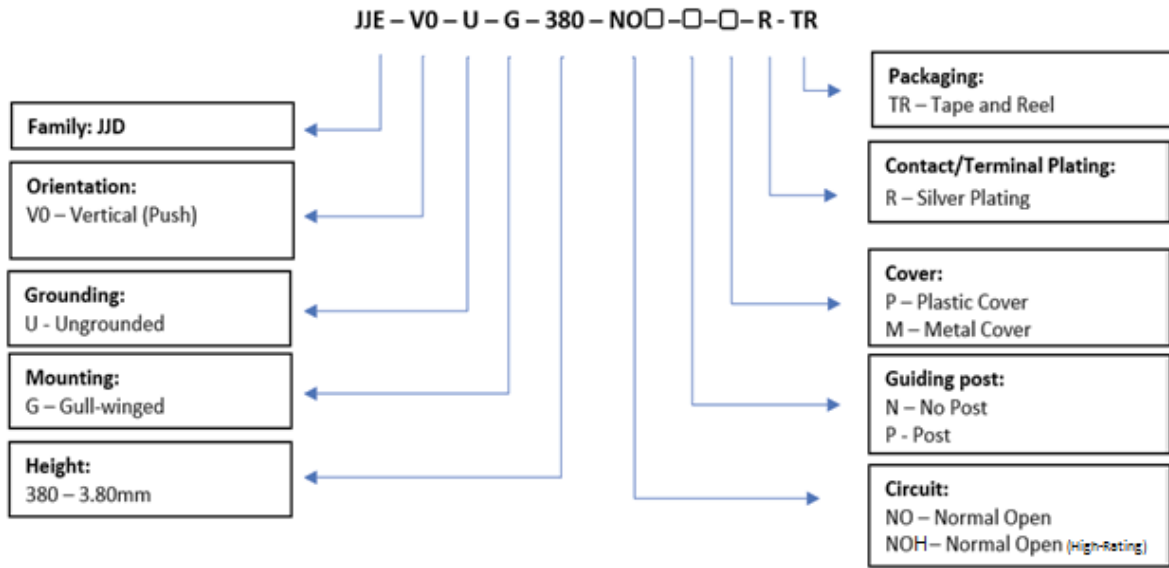

PN List

Smart PN	Orientation	Grounding	Mounting	Height	Circuit	Guiding Post	Cover	Plating	Packaging	MOQ	TE PN
JJEV0UG380NOHPMRTR	Vertical Push	Ungrounded	Gull-winged	3.80mm	NOH	Post	Metal	Silver	Tape and Reel	1,800	2331394-1
JJEV0UG380NOHNMTRTR	Vertical Push	Ungrounded	Gull-winged	3.80mm	NOH	No Post	Metal	Silver	Tape and Reel	1,800	2331395-1
JJEV0UG380NONMTRTR	Vertical Push	Ungrounded	Gull-winged	3.80mm	NO	No Post	Metal	Silver	Tape and Reel	3,000	2331417-1

Компания «Океан Электроники» предлагает заключение долгосрочных отношений при поставках импортных электронных компонентов на взаимовыгодных условиях!

Наши преимущества:

- Поставка оригинальных импортных электронных компонентов напрямую с производств Америки, Европы и Азии, а так же с крупнейших складов мира;
- Широкая линейка поставок активных и пассивных импортных электронных компонентов (более 30 млн. наименований);
- Поставка сложных, дефицитных, либо снятых с производства позиций;
- Оперативные сроки поставки под заказ (от 5 рабочих дней);
- Экспресс доставка в любую точку России;
- Помощь Конструкторского Отдела и консультации квалифицированных инженеров;
- Техническая поддержка проекта, помощь в подборе аналогов, поставка прототипов;
- Поставка электронных компонентов под контролем ВП;
- Система менеджмента качества сертифицирована по Международному стандарту ISO 9001;
- При необходимости вся продукция военного и аэрокосмического назначения проходит испытания и сертификацию в лаборатории (по согласованию с заказчиком);
- Поставка специализированных компонентов военного и аэрокосмического уровня качества (Xilinx, Altera, Analog Devices, Intersil, Interpoint, Microsemi, Actel, Aeroflex, Peregrine, VPT, Syfer, Eurofarad, Texas Instruments, MS Kennedy, Miteq, Cobham, E2V, MA-COM, Hittite, Mini-Circuits, General Dynamics и др.);

Компания «Океан Электроники» является официальным дистрибьютором и эксклюзивным представителем в России одного из крупнейших производителей разъемов военного и аэрокосмического назначения «JONHON», а так же официальным дистрибьютором и эксклюзивным представителем в России производителя высокотехнологичных и надежных решений для передачи СВЧ сигналов «FORSTAR».



JONHON

«JONHON» (основан в 1970 г.)

Разъемы специального, военного и аэрокосмического назначения:

(Применяются в военной, авиационной, аэрокосмической, морской, железнодорожной, горно- и нефтедобывающей отраслях промышленности)

«FORSTAR» (основан в 1998 г.)

ВЧ соединители, коаксиальные кабели, кабельные сборки и микроволновые компоненты:

(Применяются в телекоммуникациях гражданского и специального назначения, в средствах связи, РЛС, а так же военной, авиационной и аэрокосмической отраслях промышленности).



Телефон: 8 (812) 309-75-97 (многоканальный)

Факс: 8 (812) 320-03-32

Электронная почта: ocean@oceanchips.ru

Web: <http://oceanchips.ru/>

Адрес: 198099, г. Санкт-Петербург, ул. Калинина, д. 2, корп. 4, лит. А