

V-Series

V-Series

CONTURA II, III SWITCHES

The V-Series Contura II & III snap-in rocker switches offer countless unique options including choices for ratings, circuits, colors, illuminations and symbols. These single or double pole switches feature removable actuators in a choice of actuator styles and colors, and can be illuminated with either square or bar shaped lenses. Actuators may be purchased and stocked separately. An optional plug-in terminal connector enables pre-wiring of wire harnesses.

The Contura switches with sealed option, are certified to IP66, signifying complete protection against dust and prolonged spray and submersion under pressure, and are recognized to UL1500 - Ignition Protection for Marine Products. These switches are vibration, shock, thermoshock, moisture and salt spray resistant. Temperature ratings range from -40°C to +85°C.



Resources:

Download 3D CAD Files



Watch Product Video



Product Highlights:

- ♦ Countless options for ratings, circuits, colors, illuminations and legends
- ♦ Certified to IP66 for front panel components
- ♦ Vibration, shock, thermoshock, moisture and salt spray resistant
- ♦ Temperature range from -40°C to +85°C.

Typical Applications:

- ♦ On/Off Highway Equipment
- ♦ Marine
- ♦ Military Armored Vehicles
- ♦ Mining Machinery and Equipment
- ♦ Any application requiring environmental protection



Carling Technologies®

Innovative Designs. Powerful Solutions.

Carling Technologies, Inc.
60 Johnson Avenue, Plainville, CT 06062
Email: sales@carlingtech.com
Application Support: team2@carlingtech.com
Phone: 860.793.9281 Fax: 860.793.9231

www.carlingtech.com

V-Series Switch

DESIGN FEATURES

INTERCHANGEABLE ACTUATORS

Panel redesign is a snap with our wide range of rocker styles. Achieve maximum design variety with minimum inventory. Simply swap rockers to create an entirely new look for your panel.

DUAL SEAL PROTECTION

Seals out water, dust, debris, and enables switch certification to IP66 for front panel components.

CLEAN CONNECTIONS

Options for both eight and ten terminal base styles with AMP & Packard compatible connectors affords myriad circuit options while providing ease of assembly.

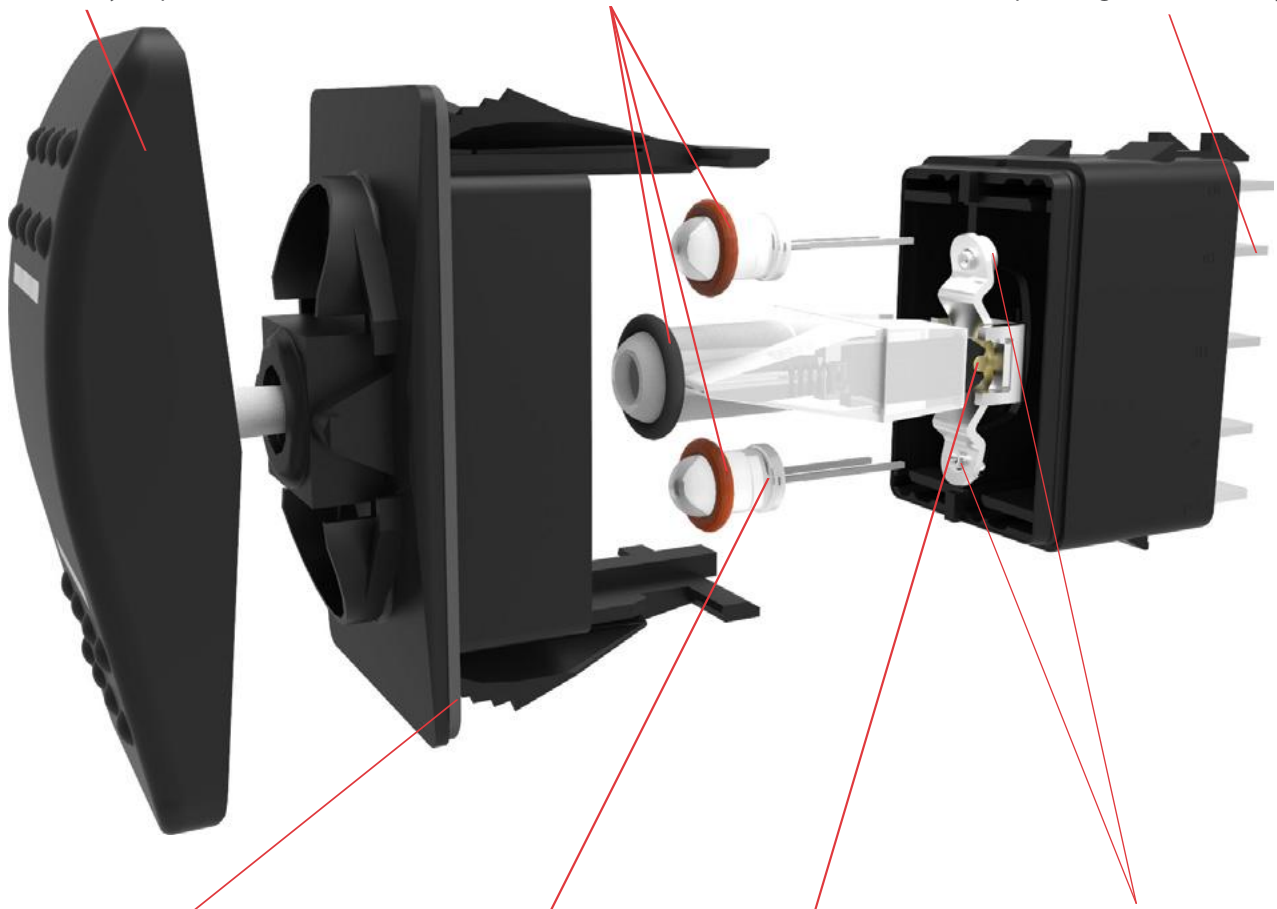

OPTIONAL PANEL SEAL

Prevents water/dust ingress behind panel.

MULTIPLE LIGHTING OPTIONS

In addition to Incandescent lamps, our LED illumination is offered in a wide array of light intensities, colors, as well as dual level, tri-color, and flashing options.

BRASS ROLLER PIN

Robust mechanism eliminates the need for lubricants. Enables switch to withstand -40°C to +85°C temperatures.

SILVER PLATED BUTT CONTACT MECHANISM

Providing 50k to 100k electrical cycles and a variety of different electrical ratings.

*Manufacturer reserves the right to change product specification without prior notice.

Contura II & III

The Contura II & III actuators are constructed of thermoplastic polycarbonate and are offered with a hard nylon overlay or a "soft-touch" elastomer overlay. These models incorporate aesthetic designs on the top and bottom of the rocker featuring two rows of raised "bumps" on the Contura II and three "indented" lines on the Contura III.



Contura X

The raised bracket/bezel on the Contura X helps prevent inadvertent actuation of the rocker, as well as preventing debris from being trapped under the actuator. This curved rocker style is available with a variety of lenses and legends.



Contura IV

The Contura IV's "Shape to create a Shape" actuator works with the curves, contours & advanced styling of the latest panel designs, flowing with these advanced curves & radii. This actuator style fits on the Contura flush bracket/bezel.



Contura XI

The raised bracket/bezel on the Contura XI helps prevent inadvertent actuation of the rocker, as well as preventing debris from being trapped under the actuator. This convex style rocker is available with a wide variety of lenses and legends.



Contura V

The symmetrically curved Contura V actuator provides the perfect complement to the Contura IV's "Shape to create a Shape" design concept. With its flush style mounting bracket, Contura V can be mounted in between two Contura IV's, by itself, or in groups.



Contura XII

The Contura XII version features a paddle style actuator with the raised bracket/bezel of Contura X and XI. The contoured handle design provides intuitive recognition and ease of operation and is available with all Contura X and XI lens and legend offerings.



Contura VI (WAVE)

The Contura VI WAVE sealed rocker switches, when used in a row, create a uniquely appealing "wave" design on your panel. A variety of colors and finishes are available for both rocker and wave insert. Contura VI features bar and oval lenses.



Contura XIV

The Contura XIV represents a sleek new crossover rocker design which should appeal to Trucks, Buses and Heavy Vehicles as well as the Marine Industry. Intuitive feel is provided by recessed ridges along with a Center Groove which effectively defines the boundary between top and bottom switch functions.



Contura VII

Contura VII featuring gently curved corners and edges assuring compatibility with most any panel design. Intuitive feel is maximized by the use of 2 embossed circular pads located at opposite ends of the rocker. Any combination of Bar or Oval style lenses can be located in the pads providing a truly unique look, exclusive to Contura VII.



Illuminated Indicators & Accessories

Alert operator of systems functions or malfunctions, are offered with removable/replaceable lamps in Contura II, II, V or X styles. Accessories include connectors, mounting panels, hole plugs, panel seals, and actuator removal tools. Refer to accessories page for full details



Electrical

Contact Rating	.4VA @ 24VDC (MAX) resistive 15 amps, 125VAC 10 amps, 250VAC 1/2 HP 125-250VAC 20 amps, 4-14VDC 15 amps, 15-28VDC 10A, 14VT 6A, 125VAC L
Dielectric Strength	1500 Volts RMS
Insulation Resistance	50 Megohms
Initial Contact Resistance	10 milliohms max. @ 4VDC
Life	50,000 - 100,000 cycles circuit dependent
Contacts	Silver alloy, silver tin-oxide, fine silver
Terminals	Brass or copper/silver plate 1/4" (6.3mm) Quick Connect terminations standard. Solder lug, Wire Lead

Mechanical

Endurance	150,000 cycles minimum circuit dependent
-----------	--

Physical

Lighted	Incandescent - rated 10,000 hours Neon - rated 25,000 hours LED - rated 100,000 hours 1/2 life (LED is internally ballasted for voltages to 24VDC)
Seals	Internal
Base	Optional external gasket panel seal Polyester blend rated to 125°C with a UL flammability rating of 94V0.
Contura II,III,IV,V, VI, VII Actuator	Hard Surface: Basic actuator structure molded of thermoplastic polycarbonate with a hard Nylon 66 thermoplastic surface overlay. Soft Surface: Basic actuator structure molded of thermoplastic polycarbonate with an elastomer overlay.
Contura X,XI,XII Actuator,VP Lens	Nylon 66 Reinforced rated to 105°C Polycarbonate rated at 100°C
Contura XIV	Polycarbonate lens/sub-rocker with ABS shell

Actuator Travel (Angular Displacement)

2 position	18°
3 positions	9° from center

Mounting Specifications

Panel Thickness Range	
Gaskets Acceptable Panel Thickness	
0	.030 to .250 (.76 to 6.35mm)
1	.030 to .109 & .147 to .157 (.76 to 2.77mm & 3.73 to 3.98mm)
Recommended: No gasket with panel thickness of .032, .062, .093, .125, .187 or .250	



Agency Certifications



Environmental

Sealing	Sealed version: IP66, this rating applies to front panel components of the actual switch only, and signifies complete protection against dust as well as powerful jets of water.
Corrosion	Mixed Flowing Gas (MFG) Class III 3 year accelerated exposure per ASTM B-827, B-845 Silver and gold contacts
Operating Temp.	-40°C to +85°C
Vibration 1	Per Mil-Std 202F, Method 204D Test Condition A 0.06 DA or 10G's 10-500 Hz. Tested with VCH connector. Test criteria - No loss of circuit during test, pre and post test contact resistance.
Vibration 2	Resonance search 24-50 Hz 0.40 DA 50-2000 Hz ±10 G's peak Horizontal Axis 3-5 G's max. Random 24 Hz 0.06 PSD-Gsq/Hz 60 Hz 0.50 100 Hz 0.50 200 Hz 0.025 2000 Hz 0.025 No loss of circuit during test; <10µ seconds chatter.
Shock	Per Mil-Std 202F, Method 213B, Test Condition K @ 30G's. Tested with VCH connector. Test criteria - No loss of circuit during test, pre and post test contact resistance.
Salt Spray	Per Mil-Std 202F, Method 101D, Test Condition A, 96 Hrs. Sealed version only.
Dust	Per Mil-Std 810C, Method 510.2 Air Velocity 300 ±200 Feet/Min, Test Duration 16 Hrs.
Thermal Shock	Per Mil-Std 202F, Method 107F, Test Cond. A, -55°C to +85°C. Test criteria - pre and post test contact resistance
Moisture Resistance	Per Mil-Std 202F, Method 106F, Test Criteria - pre and post test contact resistance
Ignition Protection	All Contura switches with sealed construction meet the requirements of UL1500/ISO8846 for ignition protection, in addition to conformance with EC directive 94/25/EC for marine products.

V 1 D A B T O B - A R B 00 - 0 00

1 Series 2 Circuit 3 Rating 4 Termination Illumination 5 Lamp 6 Lamp 7 Lamp 8 Bracket 9 Actuator 10 Lens 11 Color 12 Legend 13 Legend Orientation 14 Actuator Lens Legend

1 SERIES
V

2 CIRCUIT
Terminal Connections as viewed () - momentary from bottom of switch: SP - single pole - uses terminals 1, 2 & 3. 8 terminal 10 terminal DP - double pole uses terminals 1, 2, 3, 4, 5 & 6. 8 - -7 8 - -7 Terminals 7, 8, 9 & 10 for lamp circuit only. 1 - -4 1 - -4 2 - -5 2 - -5 3 - -6 3 - -6 10 - -9

Position:

SP	DP	2 & 3, 5 & 6	Connected Terminals	1 & 2, 4 & 5
1	A	ON	NONE	OFF
2	B	(ON)	NONE	OFF
3	C	ON	NONE	(OFF)
4	D	ON	NONE	ON
5	F	ON	NONE	(ON)
6	J	ON	OFF	ON
7	K	ON	OFF	(ON)
8	L	(ON)	OFF	(ON)

SPECIAL CIRCUITS

H*	2 & 3	2 & 3, 5 & 4	5 & 4
G*	2 & 3, 5 & 6	2 & 3	OFF
S*	2 & 3, 5 & 6	2 & 3	1 & 2
M*	(2 & 3, 5 & 6)	2 & 3	OFF
R*	(2 & 3, 5 & 6)	2 & 3	2 & 1
E*	5 & 6	5 & 3	5 & 1

*Jumper between terminals 2 & 5 for circuits H,G,M,R & S are specified in selection 4. External jumper between terminals 2 & 4 for circuit E are provided by customer. Circuit E may be used for SP OFF-ON-ON circuit.

6,7 LAMP (SAME CODING FOR BOTH SELECTIONS)
Selection 6: above terminals 1 & 4; Selection 7: above terminals 3 & 6

No lamp	0				
Neon	1	125VAC	2	250VAC	
Incandescent LED*	4	3V	5	6V	
			6	12V	7
			superbright	superbright	8
			Green	Red	24V



2VDC A Red L Amber F Green R Red
6VDC B C M N H G S T
12VDC C D P J V
24VDC

* Consult factory for "daylight bright" LED options. Typical current draw for LED is 20ma.

8 FLUSH BRACKET COLOR 1, PANEL SEAL

No Seal	Black	White	Gray
One Seal	B	W	G
	C	Y	H

9 ACTUATOR

0	No Actuator	
A, B	Contura II	
C, D	Contura III	

Actuator orientation above terminals: 3,6 1,4

10 LENS

0 - No Actuator	Z - No Lens	Blue	
Clear White	Amber	Green	Red
1 6 8	G	M	T
2 7 C	H	N	U
3 8 D	J	P	V
4 9 E	K	R	W
5 A F	L	S	Y

Lens color for LEDs must be clear, white, or match color of LED. Green or blue lenses are not recommended with Neon lamps.

3 RATING 3

1	.4VA @ 28VDC Resistive
B	15A 24V
C	20A 18V
D	20A 12V
E	20A 14V, 10A 14VT (circuit 1, 4, A & D only)
F	10A 14V, 6A 14VT (circuit G only)
M	.4VA/20A 12V
N	.4VA/15A 24V

11 ACTUATOR COLOR 1 AND TEXTURE

0 - No Actuator	Black	Gray	Red	White
Soft Surface	B	G	R	W
Hard Surface	C	H	S	Y

4 TERMINATION / BASE STYLE

8 term	10 Term	Termination	Jumper
1	2	.250 TAB (QC) no barriers	No
A	B	.250 TAB (QC) with barriers	No
J	K	.250 TAB (QC) no barriers	Yes T2 to 5
3	5	Solder Lug no barriers	No
C	D	Solder Lug	No
5	6	Wire Leads no barriers	No
E	F	Wire Leads	No

Note: Codes J & K for circuits H, G & M.

12 ACTUATOR LENS OR BODY LEGENDS 2

11 ON	12 OFF	13 I	14 O
OFF	ON	O	I
15 O O	16 O O	17 O I	18 I O
F N	N F	F	

For additional legend options & codes, visit us at www.carlingtech.com.

5 ILLUMINATION
Lamp #1: above terminals 1 & 4 end of switch.; Lamp #2 above terminals 3 & 6 end of switch. Positive (+) and negative (-) symbols apply to LED lamps only

Sealed	Unsealed	Lamps	Illumination Type	Lamp wired to Terminals
S	0	NONE	-	-
A	1	1	INDEPENDENT	8 (+) 7 (-)
B	2	1	DOWN	3 (+) 7 (-)
C	3	2	UP	3 (+) 7 (-)
D	4	1	DOWN	3 (+) 7 (-)
		2	DOWN	1 (+) 7 (-)
E	5	1	UP	1 (+) 7 (-)
		2	UP	3 (+) 7 (-)
F	6	2	INDEPENDENT	8 (+) 7 (-)
		1	UP	3 (+) 6 (-)
G	7	1	INDEPENDENT	8 (+) 7 (-)
		2	UP	3 (+) 7 (-)
H	Z	2	INDEPENDENT	8 (+) 7 (-)
U	Y	1	INDEPENDENT	8 (+) 7 (-)
		2	INDEPENDENT	10 (+) 9 (-)

SINGLE POLE SWITCHES ONLY

J	8	1	DOWN	3 (+) 8 (-)
		2	INDEPENDENT	6 (+) 7 (-)
K	W	1	INDEPENDENT	8 (+) 7 (-)
		2	INDEPENDENT	6 (+) 7 (-)

DOUBLE POLE SWITCHES ONLY

L	9	1	DOWN	3 (+) 6 (-)
M	R	1	UP	3 (+) 6 (-)
N	T	1	DOWN	3 (+) 6 (-)
		2	DOWN	1 (+) 4 (-)
P	V	1	UP	1 (+) 4 (-)
		2	UP	3 (+) 6 (-)

13 LEGEND ORIENTATION

0 No legend (used with codes 11-18 in selection 12)

1 Orientation 1

2 Orientation 2

3 Orientation 3

4 Orientation 4

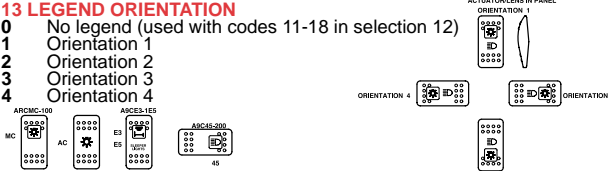

14 ACTUATOR LENS LEGEND

00 No legend this location / no actuator (used with codes 11-18 in selection 12) Selection 14 required when switch requires two legends. If the two legends consist of one lens and one body legend, lens legend must be specified in selection 12; body legend specified in selection 14. For legend options & codes, visit us at www.carlingtech.com.

Notes:

- Consult factory to verify horsepower rating for your particular circuit choice.
- Custom colors are available. Consult factory.
- Body legends not available on Soft surface actuators; White imprinting is standard on black actuators; Black imprinting is standard on white, red and gray actuators. Custom colors are available, consult factory.
- Additional ratings available. See V-Series Switch Accessories page.
- Contura II available with two square lenses. Consult factory for details.

V 1 D A S W O B - A Z E 00 - 0

1 Series 2 Circuit 3 Rating 4 Termination Illumination 5 Lock 6 Lamp 7 Bracket 8 Actuator 9 Lens 10 Function 11 Legend 12 Legend Orientation 13 Legend Orientation

1 SERIES
V

2 CIRCUIT
Terminal Connections as viewed () - momentary from bottom of switch: SP - single pole - uses terminals 1, 2 & 3. 8 terminal 10 terminal DP - double pole uses terminals 1, 2, 3, 4, 5 & 6. Terminals 7, 8, 9 & 10 for lamp circuit only.

8 - -7 8 - -7
1 - -4 1 - -4
2 - -5 2 - -5
3 - -6 3 - -6
10 - -9

Position:

SP	DP	2 & 3, 5 & 6	Connected	Terminals	1 & 2, 4 & 5
1	A	ON	NONE	OFF	
4	D	ON	NONE	ON	
6	J	ON	OFF	ON	
7	K	(ON)	OFF	(ON)	
8	L	(ON)	OFF	(ON)	
9	N	OFF	NONE	ON	

SPECIAL CIRCUITS

H*	2 & 3	2 & 3, 5 & 4	5 & 4
G*	2 & 3, 5 & 6	2 & 3	OFF
S*	2 & 3, 5 & 6	2 & 3	1 & 2
M*	(2 & 3, 5 & 6)	2 & 3	OFF
R*	(2 & 3, 5 & 6)	2 & 3	2 & 1
E*	5 & 6	5 & 3	5 & 1

*Jumper between terminals 2 & 5 for circuits H,G,M,R & S are specified in selection 4. External jumper between terminals 2 & 4 for circuit E are provided by customer. Circuit E may be used for SP OFF-ON-ON circuit.

3 RATING 4

1 .4VA @ 28VDC Resistive
B 15A 24V
C 20A 18V
D 20A 12V
E 20A 14V, 10A 14VT (circuit 1, 4, A & D only)
F 10A 14V, 6A 14VT (circuit G only)
M .4VA/20A 12V
N .4VA/15A 24V

4 TERMINATION / BASE STYLE

8 term	10 Term	Termination	Jumper
1	2	.250 TAB (QC) no barriers	No
A	B	.250 TAB (QC) with barriers	No
J	K	.250 TAB (QC) no barriers	Yes T2 to 5
3	5	Solder Lug no barriers	No
C	D	Solder Lug	No
5	6	Wire Leads no barriers	No
E	F	Wire Leads	No

Note: Codes J & K for circuits H, G & M.

5 ILLUMINATION & SWITCH SEALING
Lamp #1: above terminals 1 & 4 end of switch.; Lamp #2 above terminals 3 & 6 end of switch. Positive (+) and negative (-) symbols apply to LED lamps only

Sealed	Unsealed	Lamps	Illumination Type	Lamp wired to Terminals
S	0	NONE	-	-
C	3	2	UP	3 (+) 7 (-)
H	Z	2	INDEPENDENT	8 (+) 7 (-)

DOUBLE POLE SWITCHES ONLY

M	R	1	UP	3 (+) 6 (-)
---	---	---	----	-------------

6 LOCK
Lock above terminals 1 & 4 end of switch
W lock

7 LAMP
Lamp above terminals 3 & 6 end of switch

No lamp	0				
Neon	1	125VAC	2	250VAC	
Incandescent	4	3V	5	6V	
LED*		Red		Amber	6 12V superbright 7 18V superbright 8 24V superbright
2VDC	A		L		F
6VDC	B		M		G
12VDC	C		N		H
24VDC	D		P		J
					R
					S
					T
					V

* Consult factory for "daylight bright" LED options. Typical current draw for LED is 20ma.

8 FLUSH BRACKET COLOR 1, PANEL SEAL

No Seal	Black	White	Gray
One Seal	B	W	G
	C	Y	H

9 HARD SURFACE ACTUATOR 1

Contura II	Black	Gray	Red	White
	A	B	G	H
Contura III	C	D	E	F

Actuator orientation above terminals: 3,6 1,4

10 LENS
Z - No Lens
Clear White Amber Green Red Blue
3 8 D J P V

Lens color for LEDs must be clear, white, or match color of LED. Green or blue lenses are not recommended with Neon lamps.

11 ACTUATOR LOCK FUNCTION AND COLOR 1

Lock Color	Up	Down	Up & Down	Center 3
Match Actuator	A	H	R	1
Black	B	J	S	2
White	C	K	T	3
Red	D	L	V	4
Safety Orange	E	M	W	5

12 ACTUATOR LENS OR BODY LEGEND 2
00 - No Legend

21	22	23	24
OFF	ON	O	I
25	26	27	28
O	O	O	I
F	N		

For additional legend options & codes, visit us at www.carlingtech.com.

13 LEGEND ORIENTATION

0 No legend (used with codes 21-28 in selection 12)

1 Orientation 1
2 Orientation 2
3 Orientation 3
4 Orientation 4

Notes:
Consult factory to verify horsepower rating for your particular circuit choice.
1 Custom colors are available. Consult factory.
2 White imprinting is standard on black actuators; Black imprinting is standard on white, red and gray actuators. Custom colors are available, consult factory.
3 Only available with 3 position circuits. Center OFF and special circuits only available with center position lock function.
4 Additional ratings available. See V-Series Switch Accessories page.

Dimensional Specifications: in. [mm]

CONTURA II

SHOWN WITH SQUARE LENS



CONTURA III



8 TERMINAL BASE W/BARRIERS



8 TERMINAL BASE W/O BARRIERS



8 TERMINAL BASE W/BARRIERS



10 TERMINAL BASE W/BARRIERS



SWITCH SHOWN WITH VCH CONNECTOR 8 TERMINAL



BOTTOM VIEW TERMINAL ARRANGEMENT 8 TERMINAL BASE



BOTTOM VIEW TERMINAL ARRANGEMENT 10 TERMINAL BASE



SWITCH SHOWN WITH VC1 CONNECTOR 10 TERMINAL

Circuit Diagrams:

CIRCUIT	CIRCUIT DIAGRAM
1	
2	
3	
4	
5	
6	
7	
8	

CIRCUIT	CIRCUIT DIAGRAM
A	
B	
C	
D	
E	
F	
G	
H	

CIRCUIT	CIRCUIT DIAGRAM
J	
K	
L	
M	
R	
S	

SYMBOL LEGEND	
SYM.	DEFINITION
	DESIGNATES TERMINALS AND CONTACTS
	DESIGNATES LAMP LOCATION
	DESIGNATES MAINTAINED CIRCUITS
	DESIGNATES OTHER POSITION
	DESIGNATES MOMENTARY CIRCUITS
	DESIGNATES TWO POSITION CONNECTION
	DESIGNATES EXTERNAL JUMPER PROVIDED BY CUSTOMER

Lamp Circuit Diagrams:



Hazard Warning Circuit Diagrams:



NOTE:
J circuits are available for all non-locking V-Series styles. Consult factory for p/n details.

Reduce inventory levels and cost by stocking actuators and base switches separately.

Contura II, III, IV, V, VI, VII, X, XI, XII, XIV Base switches separately: specify **V** with code selections 2-8 in the ordering schemes.

Contura II, III, IV, V Actuator only: **VV** with code **A** or **C** for selection 9, & with selections 10-14 in the ordering schemes.

Contura VI Actuator with lenses and inserts only: **VV** with code selections 9-16

Contura II, III, IV, V, VII Actuator only: **VV** with code **A, C, E, G, P** or **Z** for selection 9 & with selections 10-14 in the ordering schemes.

Contura X, XI, XII, XIV actuators with lenses separately: **VV** with code selections 9-14 in the ordering schemes.

Panel Seal: VPS

Contura X & XI actuators without lenses separately:

VVR 6 1 00 1

1 Actuator Separately 2 Actuator Style/Color 3 Lens Opening 4 Actuator Legend 5 Legend Orientation

1 CONTURA X & XI ACTUATOR SEPARATELY
VVR

2 ACTUATOR STYLE & COLOR
Contura X Black 1 Gray 2 White 3 Red 4
Contura XI 6 7 8 9

3 LENS OPENING FOR 1
1 One bar lens 5 square lens on top/
2 One bar lenses bar lens on bottom
3 One square lens (Contura X only)
4 two square lens

4 ACTUATOR LENS OR BODY LEGEND
00 - No Legend this location
11 ON 12 OFF 13 I 14 O
OFF ON O I
15 O O 16 O O 17 O I 18 I O
F N N F
F F
For additional legend options & codes, visit us at www.carlingtech.com.

5 LEGEND ORIENTATION 1
0 No legend
1 Orientation 1
2 Orientation 2
3 Orientation 3
4 Orientation 4



Contura X, XI & XII top piece of 2-piece lens separately:

VVT 1

1 Lens Separately 2 Color

1 TOP OF LENS SEPARATELY
VVT

2 COLOR
1 Clear 2 Smoke 3 White

Contura X, XI & XII actuator lens assembly:



1 piece lens/bar lens are positioned the same as bottom lens for assembly, minus the top lens. Lenses snap in from bottom.

Notes:

- 1 If actuator lens opening for 2 bar or 2 square lenses, legend orientation 0,1, or 2 must be chosen.
- 2 Center of actuator marking not available for Contura XII.
- 3 Legend is not available for bar style lens.
- 4 Not recommended with neon lamps.
- 5 Must also order top piece of 2 piece square lens separately.

Contura XII actuators without lenses separately:

VVP J 1 Z 21 1 00

1 Actuator 2 Style & Color 3 Lens Opening 4 Lens Opening 5 Legend 6 Legend Orientation 7 Legend Orientation

1 CONTURA XII ACTUATOR SEPARATELY
VVP

2 ACTUATOR STYLE & COLOR
J Black K Gray N White M Red

3,4 LENS OPENING FOR
Z No lens 1 Bar lens 2 Square lens

5, 7 LENS OR BODY LEGEND 2
00 - No Legend 21 OFF 22 ON 23 O 24 I
25 O 26 O 27 O 28 I
F F N
For additional legend options & codes, visit us at www.carlingtech.com.

6 LEGEND ORIENTATION 3
0 No legend
1 Orientation 1
2 Orientation 2

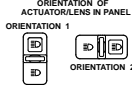

Contura X, XI & XII actuator lens assembly separately:

VVL 2 1 00 0

1 Lens Separately 2 Lens Style 3 Lens Color 4 Legend 5 Legend Orientation

1 CONTURA X, XI & XII LENS SEPARATELY
VVL

2 LENS STYLE 3
1 Bar lens
2 One Piece Square lens
3 Bottom of Two-Piece Square lens 5

3 TRANSLUCENT LENS COLOR
1 Clear 2 White 3 Amber 4 Green 4 5 Red 6 Blue 4

4 LENS OR BODY LEGEND 2
00 - No Legend 21 OFF 22 ON 23 O 24 I
25 O 26 O 27 O 28 I
F F N
For additional legend options & codes, visit us at www.carlingtech.com.

5 LEGEND ORIENTATION 3
0 No legend
1 Orientation 1
2 Orientation 2
3 Orientation 3
4 Orientation 4

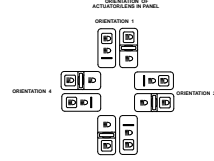

Easily integrate Contura products into your system, with Contura Accessories

Contura Connectors

Q.C. SELECTION GUIDE						
COMPANY SERIES	PART NO		WIRE RANGE		ORIENTATION	
	PLAIN BRASS	TIN PLATED BRASS	AWG	MM ² (REF)		
PACKARD 58 SERIES	02965580		12	3.0	B	
	02965471	12010601	(2)16-14	(2)1.0-2.0		
	02965470		16-14	1.0-2.0		
	02965469	06288318	20-18	.5-.8		
PACKARD METRI-PACK 630 SERIES		12084590	10	5.0	A	
		12052224	12	3.0		
		12015870	16-14	1.0-2.0		
		12020035	(2)22-18	(2).5-.8		
		12015832	12015869	20-18		.5-.8
		12052222	20-22	.35-.5		
AMP 250 SERIES FASTIN-FASTON	60253-1	60253-2	16-12	1.3-3	B	
	42100-1	42100-2	(2) 16	(2) 1.3		
	60295-1	60295-2	22-18	.3-.9		



NOTE: Consult Delphi Packard and/or Amp on actual part numbers and availability. AMP is a registered trademark of AMP Inc. Harrisburg, PA. Delphi Packard is a registered trademark of Delphi-Packard Electrical Systems Warren, Ohio



Contura X Boot (P/N VB1-01)



Contura II, III, IV & V Actuator Removal Tool (P/N VRT)



Additional V-Series Ratings

- 1 .4VA @ 28VDC Resistive
- 4 10A 250VAC 1/2 HP, 15A 125 VAC 1/2 HP, No Agency Listings
- 5¹ 10A 250VAC 1/2 HP, 15A 125 VAC 1/2 HP, UL Recognized, CSA Certified
- 6² 15A 125VAC 1/2 HP, 12(2)A 125 VAC μ T85
- 7² 15A 125VAC 1/2 HP, 12(6)A 125 VAC T85
- 8² 10A 250VAC, 15A 125VAC, 1/2 HP 125-250VAC, 12(2)A 250 VAC μ T85
- 9² 10A 250VAC, 15A 125VAC, 1/2 HP 125-250VAC, 12(6)A 250 VAC T85
- B 15A 24V
- C 20A 18V
- D 20A 12V
- E 20A 14V, 10A 14VT (circuits 1, 4, A, & D only)
- F 10A 14V, 6A, 14VT (circuit G only)
- G 20A 6V
- H 20A 3V
- L 15A 125 VAC, 10A 250VAC, 1/2 HP 125-250 VAC; 6A 125 VAC L
- M .4VA/20A 12V (combi-contact)
(combination gold/silver contacts for borderline dry circuit applications)
- N .4VA/15A 24V (combi-contact)
(combination gold/silver contacts for borderline dry circuit applications)

NOTES

Consult factory to determine availability for individual circuits and their HP rating.

1. Not available with Contura 7 or 14 rocker styles.
2. Ratings 6 - 9 are UL, CSA & VDE certified, require terminations A or B for double pole circuits, & are not available with illumination circuits 4, 8, D, J, N, & T or with wire lead or solder lug terminations.

Circuits 1, 4, A, D, H, M & E are not available with rating 6 & 8. Rating 7 & 9 only available with circuits 1, 4, A & D. Circuits 2, 3, 5, 7, 8, K, L are 1/2 HP 250VAC only with rating 8. Ratings 6 & 7 must specify lamp code 1 (125VAC neon). Ratings 8 & 9 must specify lamp code 2 (250VAC neon). Rating L available with circuits 1, 4, A & D only.

Contura Mounting Panels Dimensional Specifications: in. [mm]



Contura Hole Plug Dimensional Specifications: in. [mm]



Worldwide Headquarters

Carling Technologies, Inc.
60 Johnson Avenue, Plainville, CT 06062
Phone: 860.793.9281 **Fax:** 860.793.9231
Email: sales@carlingtech.com

Northern Region Sales Office: nrsm@carlingtech.com
Southeast Region Sales Office: sersm@carlingtech.com
Midwest Region Sales Office: mrrsm@carlingtech.com
West Region Sales Office: wrsm@carlingtech.com
Latin America Sales Office: larsm@carlingtech.com

Asia-Pacific Headquarters

Carling Technologies, Asia-Pacific Ltd.,
Kowloon, Hong Kong
Phone: Int + 852-2737-2277 **Fax:** Int + 852-2736-9332
Email: sales@carlingtech.com.hk

Shenzhen, China: shenzhen@carlingtech.com
Shanghai, China: shanghai@carlingtech.com
Pune, India: india@carlingtech.com
Kaohsiung, Taiwan: taiwan@carlingtech.com
Yokohama, Japan: japan@carlingtech.com

Europe | Middle East | Africa Headquarters

Carling Technologies LTD
4 Airport Business Park, Exeter Airport,
Clyst Honiton, Exeter, Devon, EX5 2UL, UK
Phone: Int + 44 1392.364422 **Fax:** Int + 44 1392.364477
Email: ltd.sales@carlingtech.com

Germany: gmbh@carlingtech.com
France: sas@carlingtech.com



Carling Technologies®

Innovative Designs. Powerful Solutions.

Компания «Океан Электроники» предлагает заключение долгосрочных отношений при поставках импортных электронных компонентов на взаимовыгодных условиях!

Наши преимущества:

- Поставка оригинальных импортных электронных компонентов напрямую с производств Америки, Европы и Азии, а так же с крупнейших складов мира;
- Широкая линейка поставок активных и пассивных импортных электронных компонентов (более 30 млн. наименований);
- Поставка сложных, дефицитных, либо снятых с производства позиций;
- Оперативные сроки поставки под заказ (от 5 рабочих дней);
- Экспресс доставка в любую точку России;
- Помощь Конструкторского Отдела и консультации квалифицированных инженеров;
- Техническая поддержка проекта, помощь в подборе аналогов, поставка прототипов;
- Поставка электронных компонентов под контролем ВП;
- Система менеджмента качества сертифицирована по Международному стандарту ISO 9001;
- При необходимости вся продукция военного и аэрокосмического назначения проходит испытания и сертификацию в лаборатории (по согласованию с заказчиком);
- Поставка специализированных компонентов военного и аэрокосмического уровня качества (Xilinx, Altera, Analog Devices, Intersil, Interpoint, Microsemi, Actel, Aeroflex, Peregrine, VPT, Syfer, Eurofarad, Texas Instruments, MS Kennedy, Miteq, Cobham, E2V, MA-COM, Hittite, Mini-Circuits, General Dynamics и др.);

Компания «Океан Электроники» является официальным дистрибьютором и эксклюзивным представителем в России одного из крупнейших производителей разъемов военного и аэрокосмического назначения «JONHON», а так же официальным дистрибьютором и эксклюзивным представителем в России производителя высокотехнологичных и надежных решений для передачи СВЧ сигналов «FORSTAR».



JONHON

«JONHON» (основан в 1970 г.)

Разъемы специального, военного и аэрокосмического назначения:

(Применяются в военной, авиационной, аэрокосмической, морской, железнодорожной, горно- и нефтедобывающей отраслях промышленности)

«FORSTAR» (основан в 1998 г.)

ВЧ соединители, коаксиальные кабели, кабельные сборки и микроволновые компоненты:

(Применяются в телекоммуникациях гражданского и специального назначения, в средствах связи, РЛС, а так же военной, авиационной и аэрокосмической отраслях промышленности).



Телефон: 8 (812) 309-75-97 (многоканальный)

Факс: 8 (812) 320-03-32

Электронная почта: ocean@oceanchips.ru

Web: <http://oceanchips.ru/>

Адрес: 198099, г. Санкт-Петербург, ул. Калинина, д. 2, корп. 4, лит. А