

SST-10-UV

Surface Mount UV LED

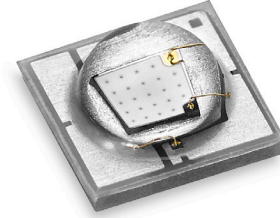

Table of Contents

Technology Overview	2
Binning Structure	3
Ordering Information	4
Ordering Bin Kits	4
Optical & Electrical Characteristics	5
Typical Spectrum	7
Radiation Pattern	7
Thermal Resistance	8
Mechanical Dimensions	9
Tape and Reel Outline	10
Soldering Profile	11
Packaging and shipping specifications	12
Revision History	13

Features:

- High Power UV LED with peak wavelengths 365 nm, 385 nm, 395 nm and 405 nm
- Industry standard 3.5 mm x 3.5 mm package
- 130° viewing angle
- Low Thermal Resistance : 1.4 °C/W
- Built-in ESD Protection
- Environmentally friendly: REACH, RoHS and Halogen compliant

Applications:

- Curing- inks, coating and adhesives
- Photocatalytic air/water purification
- Medical and Analytic instrumentation
- Diagnostics
- Fluorescence Imaging

Technology Overview

Luminus LEDs benefit from innovations in device technology, chip packaging and thermal management. This suite of technologies give engineers and system designers the freedom to develop solutions high both in power and in efficiency.

Luminus Surface Mount LED Technology

Luminus' vertical chip technology enables uniform and high brightness over the entire chip surface.

Thermal management is critical in high power LED applications. With a thermal resistance (R_{th}) from junction to board of 1.4 °C/W, the SST-10 has one of the lowest thermal resistances of UV LEDs in the market. The low R_{th} , along with Luminus vertical chip technology allows users to drive the LEDs at high current densities while maintaining a low junction temperature, thereby resulting in brighter solutions and longer lifetimes.

Reliability

Luminus LEDs are one of the most reliable light sources in the world. They pass a rigorous suite of environmental and mechanical stress tests, including mechanical shock, vibration, temperature cycling and humidity, and have been qualified for use in high power and high current applications. Luminus UV LEDs are designed for the most demanding applications with median lifetimes exceeding 30,000 hours.

Environmental Benefits

Luminus LEDs help reduce power consumption and the amount of hazardous waste entering the environment. All Luminus LEDs are RoHS and Halogen compliant and free of hazardous materials, including lead and mercury.

Binning Structure

SST-10-UV LEDs are specified for flux and peak wavelength at a drive current of 500 mA with a 20 ms pulse at 25°C and placed into one of the following Flux Bins and Peak Wavelength Bins.

Flux Bins¹

Color	Power Flux Bin (FF)	Minimum Flux (W)	Maximum Flux (W)
UV	E	720	810
	F	810	900
	G	900	990
	H	990	1080
	I	1080	1170

Note 1: Luminus maintains a +/- 6% tolerance on power measurements.

Peak Wavelength Bins

Color	Wavelength Bin (WWW)	Minimum Wavelength (nm)	Maximum Wavelength (nm)
UV	365	365	370
	370	370	375
	380	380	385
	385	385	390
	390	390	395
	395	395	400
	400	400	405
	405	405	410

Ordering Information

Products	Ordering Part Number	Description
SST-10-UV	SST-10-UV-A130-FFWWW-00 SST-10-UV-B130-FFWWW-00	UV LED in a 3535 surface mount package with a 130 degree molded lens

Part Number Nomenclature

SST — 10 — UV — X130 — FFWWW-00

Product Family	Chip Area	Color	Package Configuration ¹	Bin Kit ^{2,3}
SST: Surface Mount package	10: 1 mm ²	UV = Ultraviolet	A130 : "A" solder pad layout and 130 ° lens B130 : "B" solder pad layout and 130 ° lens	See ordering bin kits table below for complete bin definition

Note 1: Refer to drawings on page 9 for details on "A" and "B" solder pad layouts

Note 2: A Bin Kit represents a group of flux and wavelength bins that are shippable for a given ordering part number. Individual bins are not orderable..

Note 3: Flux Bin listed is minimum bin shipped - higher bins may be included at Luminus' discretion

Ordering Bin Kits

Wavelength Range (nm)	Luminous Flux		Wavelength Bins	Ordering Bin Kit Number
	Bin Kit Flux Code	Min. Flux (mW)		
365-375	E	720	365, 370	E365-00
	F	810	365, 375	F365-00

380-390	G	900	380, 385	G385-00
---------	---	-----	----------	---------

390-400	G	900	390, 395	G395-00
---------	---	-----	----------	---------

400-410	F	810	400,405	F405-00
---------	---	-----	---------	---------

Optical & Electrical Characteristics ($T_{hs} = 25^{\circ}\text{C}$)

UV						
Parameter	Symbol	Values ⁴				Unit
Peak Wavelength Range	λ	365-375	380-390	390-400	400-410	nm
Test Current for binning ⁵	I	500	500	500	500	mA
Peak Wavelength Typ.	λ_p	370	385	395	405	nm
Forward Voltage	$V_{F\ min}$	3.0	3.0	3.0	3.0	V
	V_F	3.7	3.4	3.3	3.3	V
	$V_{F\ max}$	4.0	4.0	4.0	4.0	V
Radiometric Flux ⁶	Φ_{typ}	875	1015	1015	930	mW
FWHM at 50% of Φ	$\Delta\lambda_{1/2}$	10	10	10	10	nm
Viewing Angle	$2\Phi_{1/2}$	130	130	130	130	degrees

Parameter	Symbol	Values
Absolute Maximum Current (CW) ⁷	I_{max}	365 nm- 1A 385-405 nm- 1.5 A
Maximum Junction Temperature ⁷	T_{jmax}	100 °C
Storage Temperature Range	T_s	-40 to +100 °C
Soldering Temperature	T_{SLD}	JEDEC J-STD-020C, 260 °C
ESD Sensitivity (HBM)	V_B	6000 V

Note 4: Unless otherwise noted, values listed are typical. Devices are production tested and specified at 500 mA with a 20 ms pulse at 25°C.

Note 5: While SST-10-UV devices are tested at 500 mA, they can be driven at CW currents ranging from 200 mA to 1.5 A and at duty cycles ranging from 1% to 100%. Drive current and duty cycle should be adjusted as necessary to maintain the junction temperature desired to meet application lifetime requirements.

Note 6: Typical radiometric flux is for reference only. Minimum flux values are guaranteed based on the bin kit ordered. For product roadmap and future performance of devices, contact Luminus.

Note 7: SST-10-UV LEDs are designed for operation to an absolute maximum current as specified above. Product lifetime data is specified at or below maximum drive current. Sustained operation beyond absolute maximum currents will result in a reduction of device life time. Actual device lifetimes will also depend on junction temperature and operation beyond maximum junction temperature is not recommended. Contact Luminus for lifetime derating curves and for further information. In pulsed operation, rise time from 10-90% of forward current should be longer than 0.5 μseconds.

Optical & Electrical Characteristics

Relative Power vs. Forward Current

$\phi/\phi_{(500\text{ mA})}$, 20 ms pulse, $T_j = 25^\circ\text{C}$

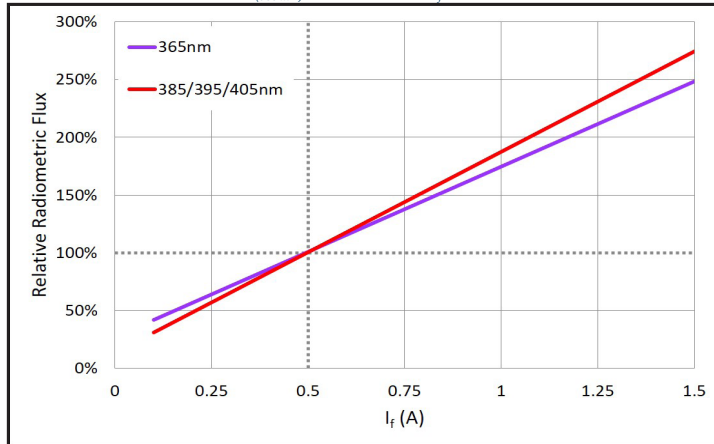

Relative Power vs. Junction Temperature

$\phi/\phi_{(25^\circ\text{C})}$, 20 ms pulse, 500 mA

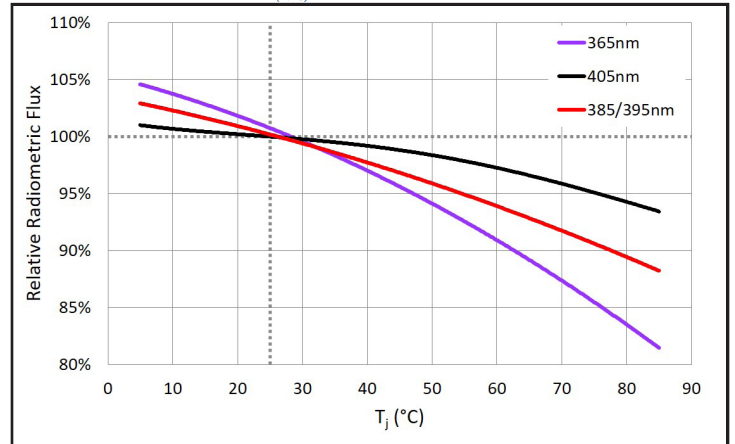

Peak Wavelength Shift vs. Forward Current

$\lambda_p = \lambda_p(I_f) - \lambda_p(500\text{ mA})$, 20 ms pulse, $T_j = 25^\circ\text{C}$

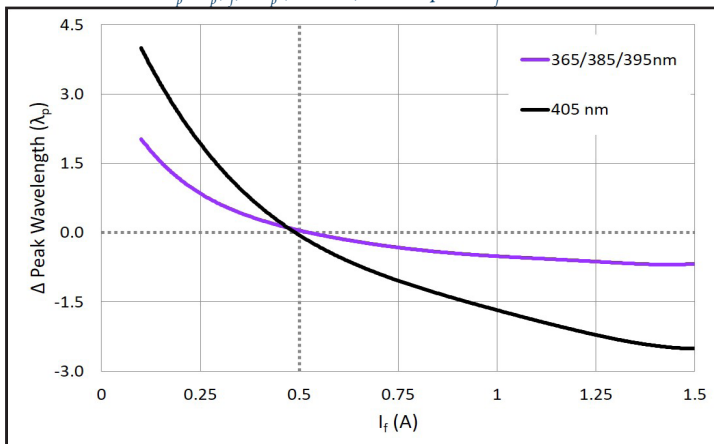

Peak Wavelength Shift vs. Junction Temperature

$\lambda_p = \lambda_p(T_j) - \lambda_p(25^\circ\text{C})$, 20 ms pulse, $I_f = 500\text{ mA}$

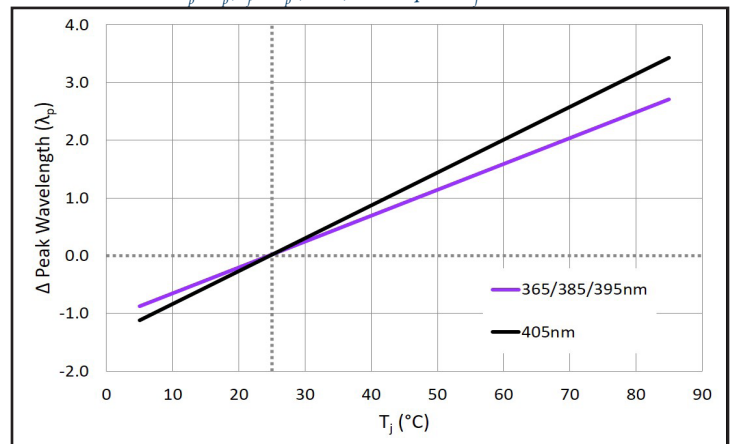

Forward Voltage vs Forward Current

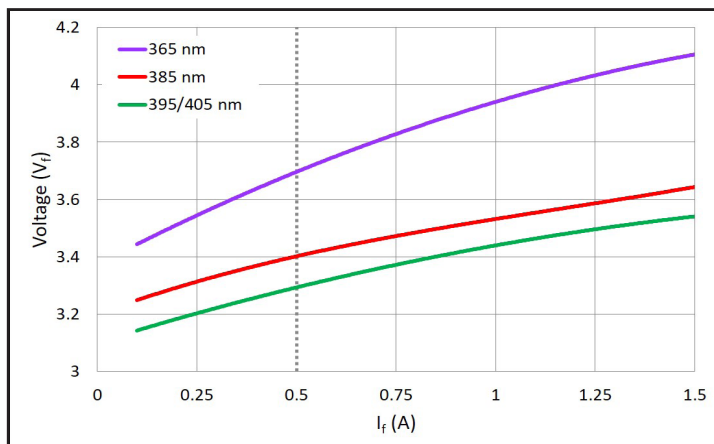

Forward Voltage Shift vs. Junction Temperature

$\Delta V_f = V_f(T_j) - V_f(25^\circ\text{C})$, 20 ms pulse, $I_f = 500\text{ mA}$



Typical Spectrum⁸



Radiation Pattern⁹



Note 8: Typical spectrum at 500 mA drive current.

Note 9: Detailed information on radiation pattern including ray trace files can be found at: <http://www.luminus.com>

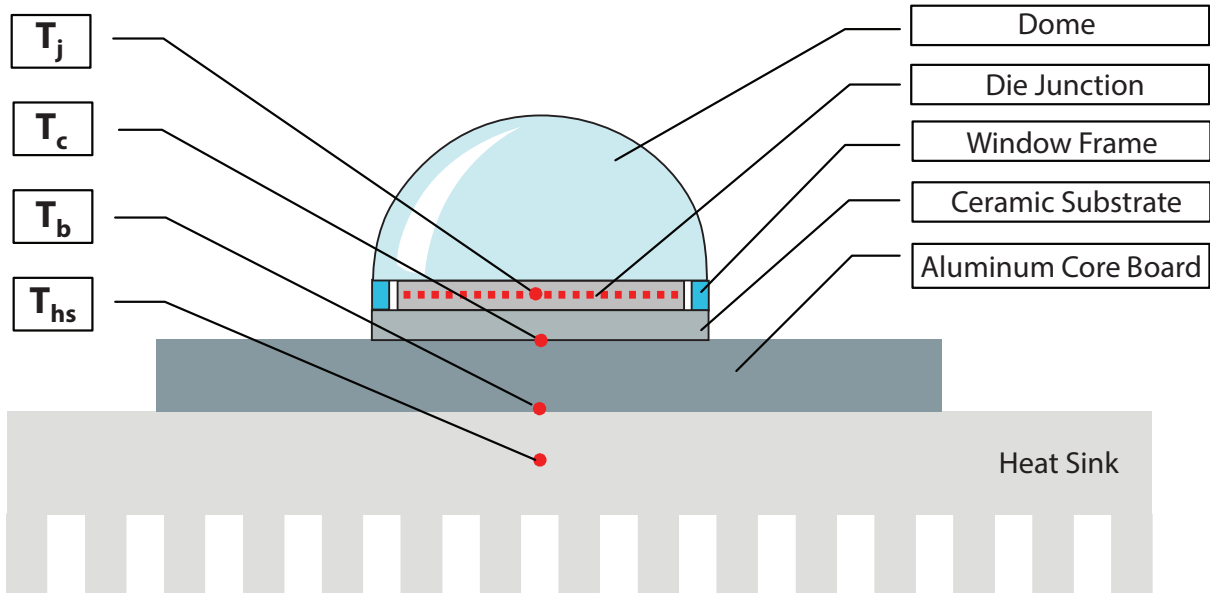
Thermal Resistance

T_{hs} definition = 3 mm from core-board

$R_{\theta j-b}^{10}$	1.4 °C/W
-----------------------	----------

Note 10: Electrical thermal resistance based on input electrical power at 500 mA and measured per JESD51-14

Mechanical Dimensions - A130 package

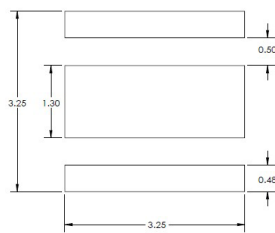
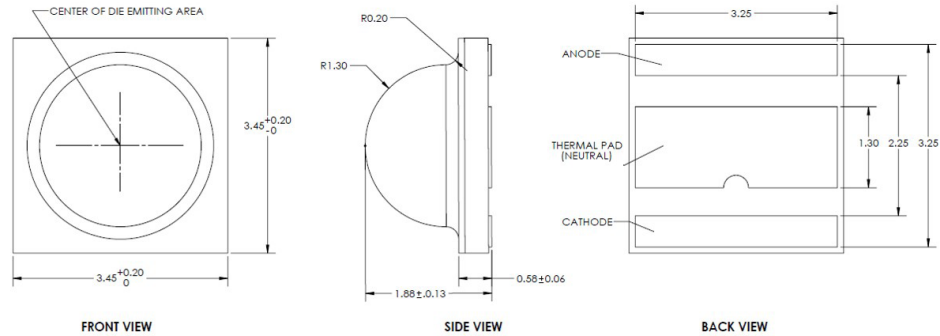

Recommended PCB Solder Pad

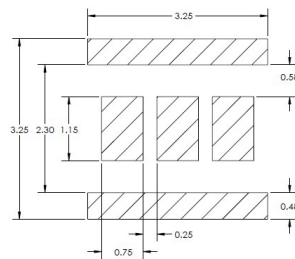

Recommended Stencil Pattern

DWG-002848

Mechanical Dimensions - B130 package

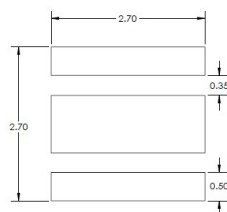
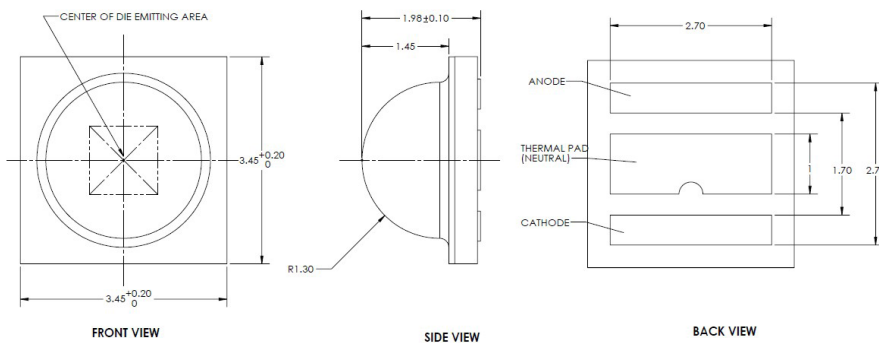

Recommended PCB Solder Pad

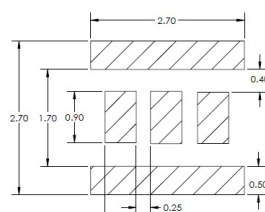

Recommended Stencil Pattern

DWG-003005

Tape and Reel Outline

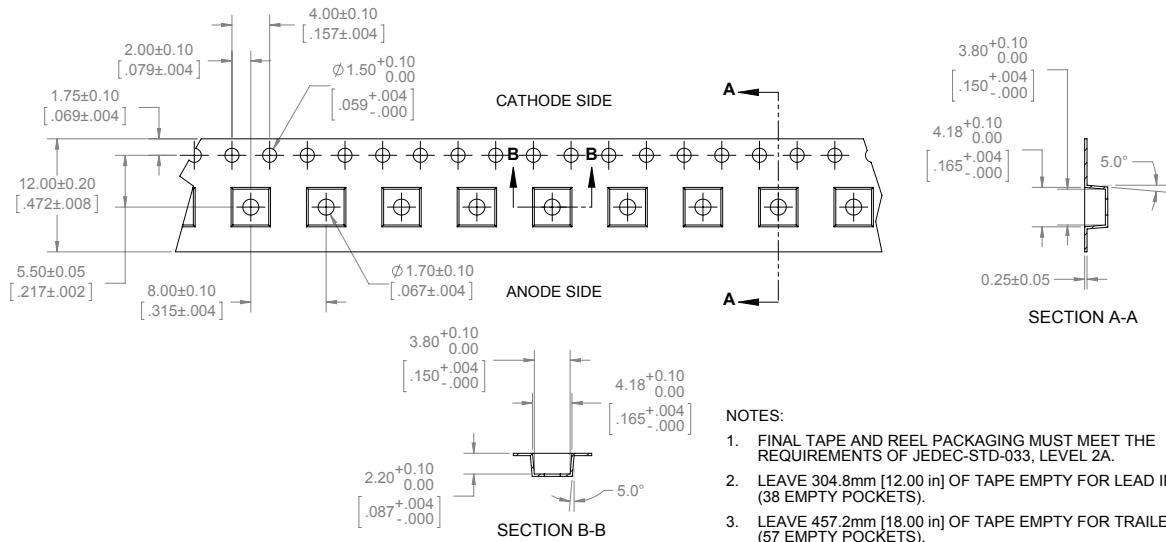

- NOTES:**
1. FINAL TAPE AND REEL PACKAGING MUST MEET THE REQUIREMENTS OF JEDEC-STD-033, LEVEL 2A.
 2. LEAVE 304.8mm [12.00 in] OF TAPE EMPTY FOR LEAD IN (38 EMPTY POCKETS).
 3. LEAVE 457.2mm [18.00 in] OF TAPE EMPTY FOR TRAILER (57 EMPTY POCKETS).
 4. MUST COMPLY TO EIA-481-C-2003

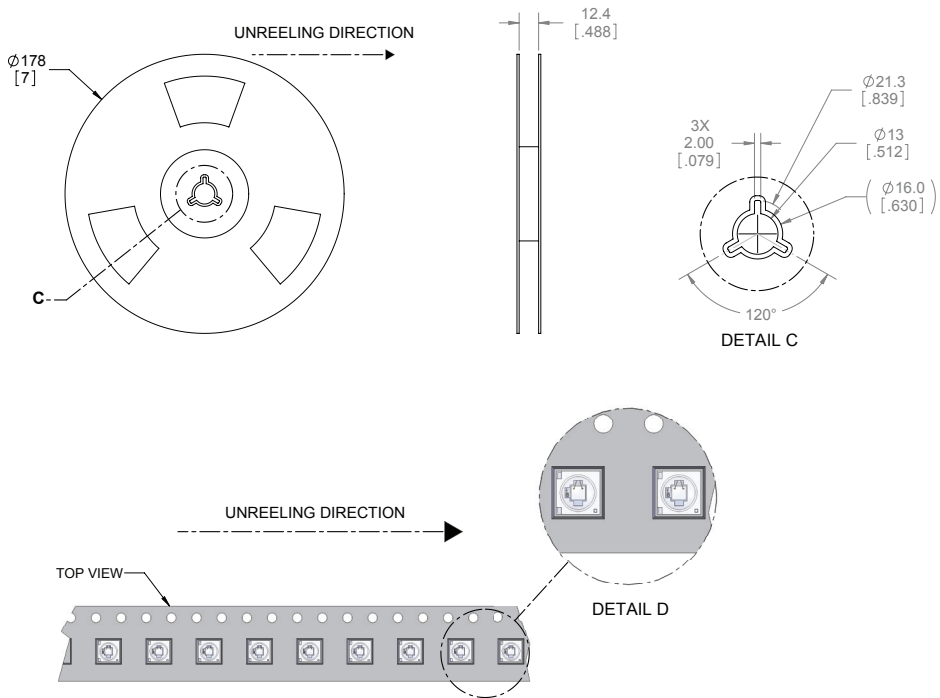

Soldering Profile

Profile Feature	Sn-Pb Eutectic Assembly	Pb-Free Assembly
Preheat & Soak		
Temperature min (T _{smin})	100 °C	150 °C
Temperature max (T _{smax})	150 °C	200 °C
Time (T _{smin} to T _{smax}) (t _s)	60-120 seconds	60-120 seconds
Average ramp-up rate (T _{smax} to T _p)	3 °C/second max	3 °C/second max
Liquidous temperature (T _L)	183 °C	217 °C
Time at liquidous (t _L)	60-150 seconds	60-150 seconds
Peak package body temperature (T _p)*	230 °C ~235 °C	255 °C ~260 °C
Classification temperature (T _c)	235 °C	260 °C
Time (t _p) within 5 °C of the specified classification temperature (T _c)	20 seconds	30 seconds
Average ramp-down rate (T _p to T _{smax})	6 °C/second max	6 °C/second max
Time 25 °C to peak temperature	6 minutes max	8 minutes max

* Tolerance for peak profile temperature(T_p) is defined as a supplier minimum and a user maximum.

** Tolerance for time at peak profile temperature(t_p) is defined as a supplier minimum and a user maximum.

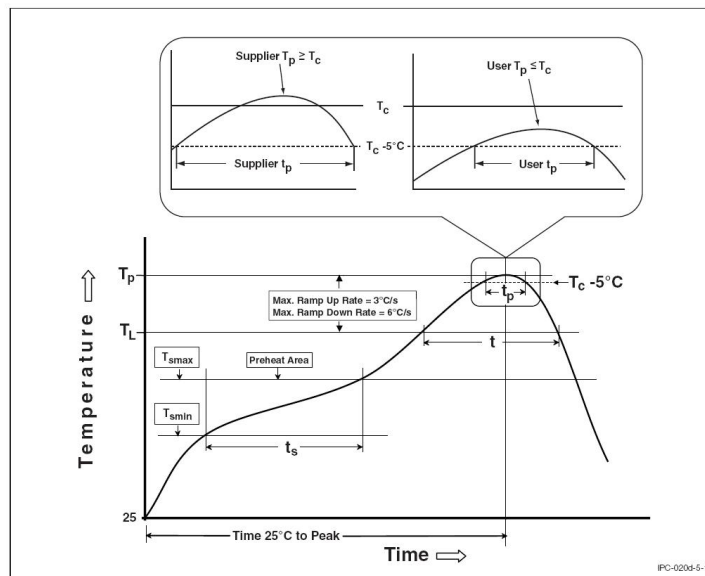

Packing and Shipping Specifications

Product Label Specification

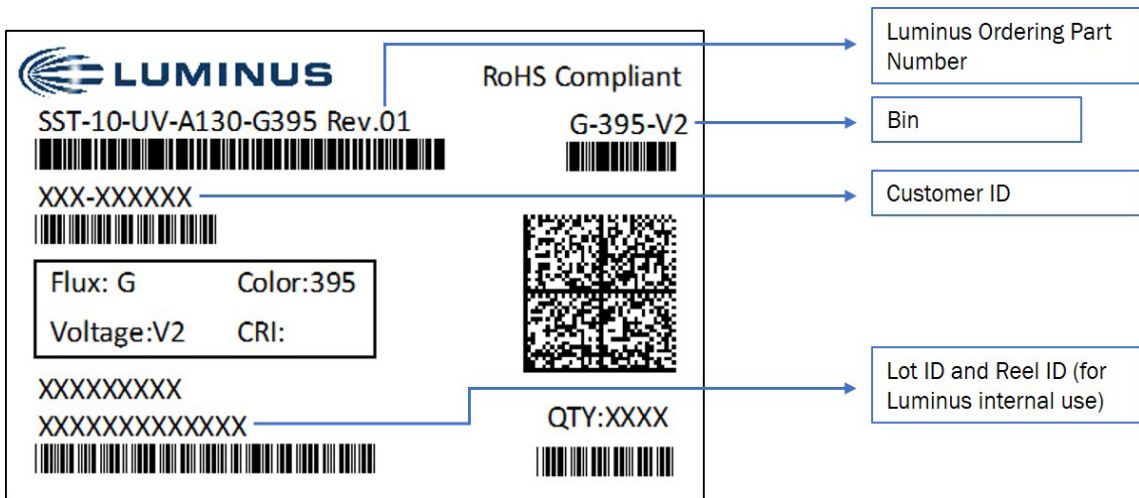

Sample label –for illustration only

Shipping Box

Box Packaging Information

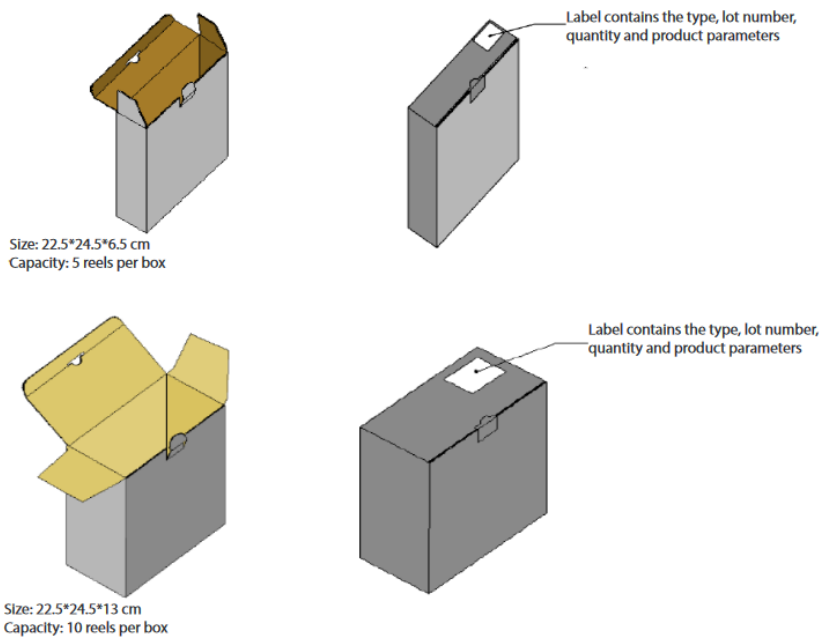

Revision History

Rev	Date	Description of Change
01	06/01/2018	Initial Release
02	8/31/2018	Added "B130" version: updated ordering part numbers, characterization graphs and mechanical drawings



The products, their specifications and other information appearing in this document are subject to change by Luminus Devices without notice. Luminus Devices assumes no liability for errors that may appear in this document, and no liability otherwise arising from the application or use of the product or information contained herein. None of the information provided herein should be considered to be a representation of the fitness or suitability of the product for any particular application or as any other form of warranty. Luminus Devices' product warranties are limited to only such warranties as accompany a purchase contract or purchase order for such products. Nothing herein is to be construed as constituting an additional warranty. No information contained in this publication may be considered as a waiver by Luminus Devices of any intellectual property rights that Luminus Devices may have in such information.

This product is protected by U.S. Patents 6,831,302; 7,074,631; 7,083,993; 7,084,434; 7,098,589; 7,105,861; 7,138,666; 7,166,870; 7,166,871; 7,170,100; 7,196,354; 7,211,831; 7,262,550; 7,274,043; 7,301,271; 7,341,880; 7,344,903; 7,345,416; 7,348,603; 7,388,233; 7,391,059 Patents Pending in the U.S. and other countries.

Компания «Океан Электроники» предлагает заключение долгосрочных отношений при поставках импортных электронных компонентов на взаимовыгодных условиях!

Наши преимущества:

- Поставка оригинальных импортных электронных компонентов напрямую с производств Америки, Европы и Азии, а так же с крупнейших складов мира;
- Широкая линейка поставок активных и пассивных импортных электронных компонентов (более 30 млн. наименований);
- Поставка сложных, дефицитных, либо снятых с производства позиций;
- Оперативные сроки поставки под заказ (от 5 рабочих дней);
- Экспресс доставка в любую точку России;
- Помощь Конструкторского Отдела и консультации квалифицированных инженеров;
- Техническая поддержка проекта, помощь в подборе аналогов, поставка прототипов;
- Поставка электронных компонентов под контролем ВП;
- Система менеджмента качества сертифицирована по Международному стандарту ISO 9001;
- При необходимости вся продукция военного и аэрокосмического назначения проходит испытания и сертификацию в лаборатории (по согласованию с заказчиком);
- Поставка специализированных компонентов военного и аэрокосмического уровня качества (Xilinx, Altera, Analog Devices, Intersil, Interpoint, Microsemi, Actel, Aeroflex, Peregrine, VPT, Syfer, Eurofarad, Texas Instruments, MS Kennedy, Miteq, Cobham, E2V, MA-COM, Hittite, Mini-Circuits, General Dynamics и др.);

Компания «Океан Электроники» является официальным дистрибьютором и эксклюзивным представителем в России одного из крупнейших производителей разъемов военного и аэрокосмического назначения «JONHON», а так же официальным дистрибьютором и эксклюзивным представителем в России производителя высокотехнологичных и надежных решений для передачи СВЧ сигналов «FORSTAR».



JONHON

«JONHON» (основан в 1970 г.)

Разъемы специального, военного и аэрокосмического назначения:

(Применяются в военной, авиационной, аэрокосмической, морской, железнодорожной, горно- и нефтедобывающей отраслях промышленности)

«FORSTAR» (основан в 1998 г.)

ВЧ соединители, коаксиальные кабели, кабельные сборки и микроволновые компоненты:

(Применяются в телекоммуникациях гражданского и специального назначения, в средствах связи, РЛС, а так же военной, авиационной и аэрокосмической отраслях промышленности).



Телефон: 8 (812) 309-75-97 (многоканальный)

Факс: 8 (812) 320-03-32

Электронная почта: ocean@oceanchips.ru

Web: <http://oceanchips.ru/>

Адрес: 198099, г. Санкт-Петербург, ул. Калинина, д. 2, корп. 4, лит. А