

Energy-saving axial fans

version 03/2009



The engineer's choice

ebmpapst

New energy-saving axial fans

The new generation of compact energy-saving axial fans

In almost all spheres of life, energy savings have become an important issue by now. Our new and compact axial fans are based on the energy-saving motor (ESM) and offer high efficiency and thus considerable energy savings and improved service life at the same time - aspects which are definitely called for with refrigeration plants, such as refrigerated display cases or refrigeration chests or condensing units.

The axial fan W1G 200 already established quite successfully on the market has now been complemented by the sizes 172, 230, 250 and 300 mm. The new plastic rotor was optimised to meet improved aerodynamic criteria and makes these fans operate even more quietly. What is more, they environment benefits from the fact that no varnish needs to be used any more!

Compared to conventional shaded pole motors, energy-saving motors are three times as efficient. Higher efficiency translates into less intrinsic heat generated during operation, with a reduced need to dissipate heat and putting a strain on the environment. This results in further energy savings, as less refrigeration capacity has to be applied in the first instance.

The new and compact energy-saving axial fans, with an output power of between 5 and 20 W, can be easily connected via a plug-in connection. Moreover, the motor speed can be optionally set via programming interface. A second speed step - e.g. for night setback, can be realised via actuator input.

The energy-saving fans are robust, maintenance-free and durable. Their service life is rated at more than 40,000 hours, equalling continuous operation of more than 4.5 years. As regards environmental impacts, their design complies with protection type IP 54 specifications. Optionally, protection type IP 65 is available. Moreover, these energy-saving axial fans comply with protection class 2.

Table of content



■ New energy-saving axial fans	2
■ Size 172	4
■ Size 200	6
■ Size 230	12
■ Size 250	14
■ Size 300	16
■ Connection leads	20
■ ebm-papst representatives & subsidiaries	22

Energy-saving axial fans

Ø 172



- **Material:** Wall ring: Plastic PP
Blade: Plastic PA
- **Number of blades:** 5
- **Direction of air flow:** "V", exhaust over struts
- **Direction of rotation:** Counter-clockwise seen on rotor
- **Type of protection:** IP 54
- **Insulation class:** "B"
- **Mounting position:** Any
- **Condensate discharges:** None
- **Mode of operation:** Continuous operation (S1)
- **Bearings:** Maintenance-free ball bearings
- **Motor protection:** Via electronics and TOP
- **Electrical connection:** Line cord with plug
- **Protection class:** II
- **Product conforming to standard:** CE
- **Approvals:** VDE; UL, CSA is applied for
- **Speed:** Using the programming unit, 2 speeds between n_{min} and n_{max} can be programmed.

Nominal data

Type	Motor	Curve	Nominal voltage VAC	Frequency Hz	Speed (1) rpm	Max. Power input (1) W	Max. Current draw (1) A	Max. operative range Pa	Perm. amb. temp. °C	Mass kg
W1G172-EC95 -01	M1G 055-BD	A	115	50/60	2400	22	0,34	55	-30..+50	0,95
W1G172-EC91 -01	M1G 055-BD	B	230	50/60	2400	22	0,17	55	-30..+50	0,95

subject to alterations

(1) Nominal data in operating point with maximum load and 115 or 230 VAC

Curves

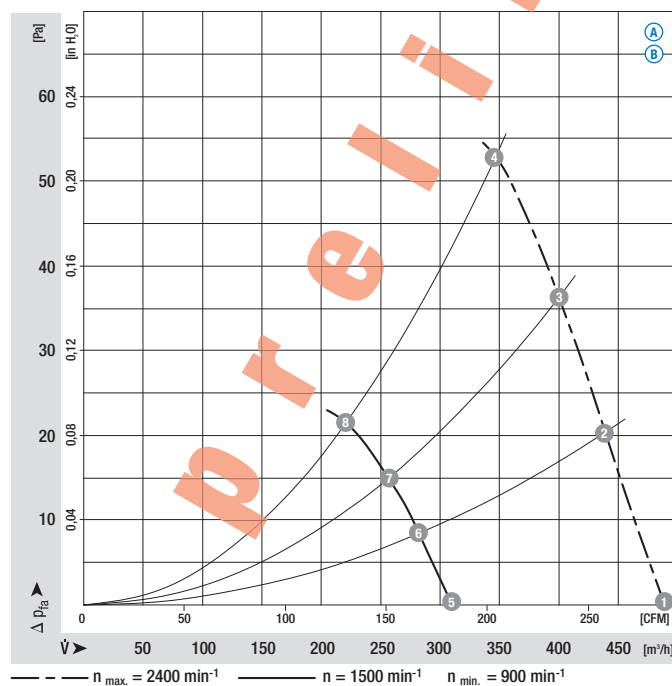

	n [rpm]	P ₁ [W]	I [A]	Lp _A [dB(A)]
A 1	2400	19	0,30	53
A 2	2400	21	0,32	53
A 3	2400	22	0,34	53
A 4	2400	22	0,34	53
A 5	1500	8	0,12	42
A 6	1500	8	0,14	43
A 7	1500	9	0,14	43
A 8	1500	9	0,14	44
B 1	2400	19	0,15	53
B 2	2400	21	0,16	53
B 3	2400	22	0,17	53
B 4	2400	22	0,17	53
B 5	1500	8	0,06	42
B 6	1500	8	0,07	43
B 7	1500	9	0,07	43
B 8	1500	9	0,07	44

- Electr. connection:

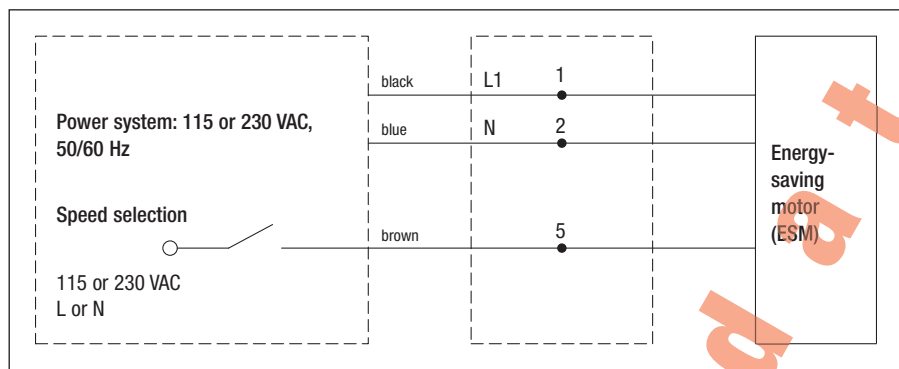

Energy-saving axial fans

Ø 200



- **Material:** Wall ring: Plastic PP
Blade: Plastic PA
- **Number of blades:** 5
- **Direction of air flow:** "V", exhaust over struts
- **Direction of rotation:** Counter-clockwise seen on rotor
- **Type of protection:** IP 54
- **Insulation class:** "B"
- **Mounting position:** Any
- **Condensate discharges:** None
- **Mode of operation:** Continuous operation (S1)
- **Bearings:** Maintenance-free ball bearings
- **Motor protection:** Via electronics and TOP
- **Electrical connection:** Line cord with plug
- **Protection class:** II
- **Product conforming to standard:** CE
- **Approvals:** VDE;
UL, CSA is applied for
- **Speed:** Using the programming unit, 2 speeds between n_{min} and n_{max} can be programmed.

Nominal data		Curve	Nominal voltage	Frequency	Speed ⁽¹⁾	Max. Power input ⁽¹⁾	Max. Current draw ⁽¹⁾	Max. operative range	Perm. amb. temp.	Mass
Type	Motor	VAC	Hz	rpm	W	A	Pa	°C	kg	
W1G200-EC91 -27	M1G 055-BD	A	115	50/60	1300	8,0	0,11	24	-30..+50	1,0
W1G200-EC87 -25	M1G 055-BD	B	230	50/60	1300	8,5	0,07	24	-30..+50	1,0

subject to alterations

⁽¹⁾ Nominal data in operating point with maximum load and 115 or 230 VAC

Curves

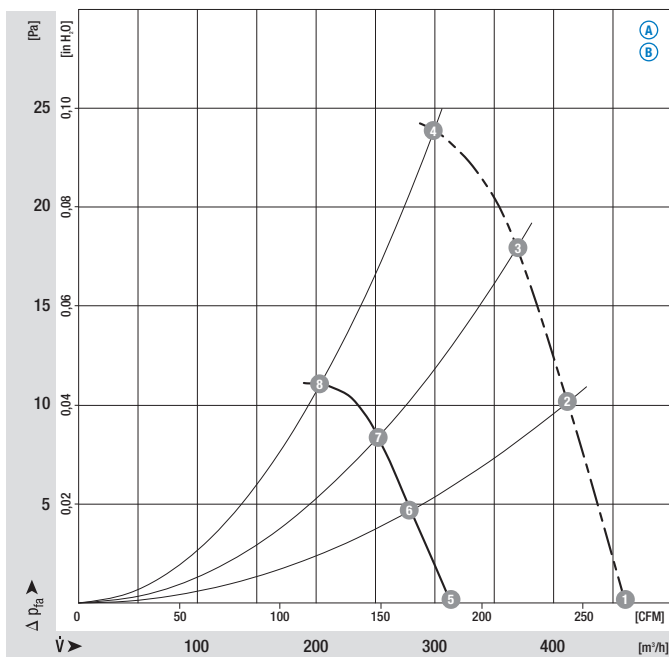

	n [rpm]	P ₁ [W]	I [A]	Lp _A [dB(A)]
A 1	1300	7	0,09	42
A 2	1300	8	0,10	41
A 3	1300	8	0,10	41
A 4	1300	8	0,11	42
A 5	900	3	0,05	33
A 6	900	4	0,05	32
A 7	900	4	0,05	32
A 8	900	4	0,05	33
B 1	1300	7	0,06	42
B 2	1300	8	0,07	41
B 3	1300	8,5	0,07	41
B 4	1300	8,5	0,07	42
B 5	900	3	0,03	33
B 6	900	4	0,04	32
B 7	900	4	0,04	32
B 8	900	4	0,04	33

– Electr. connection:

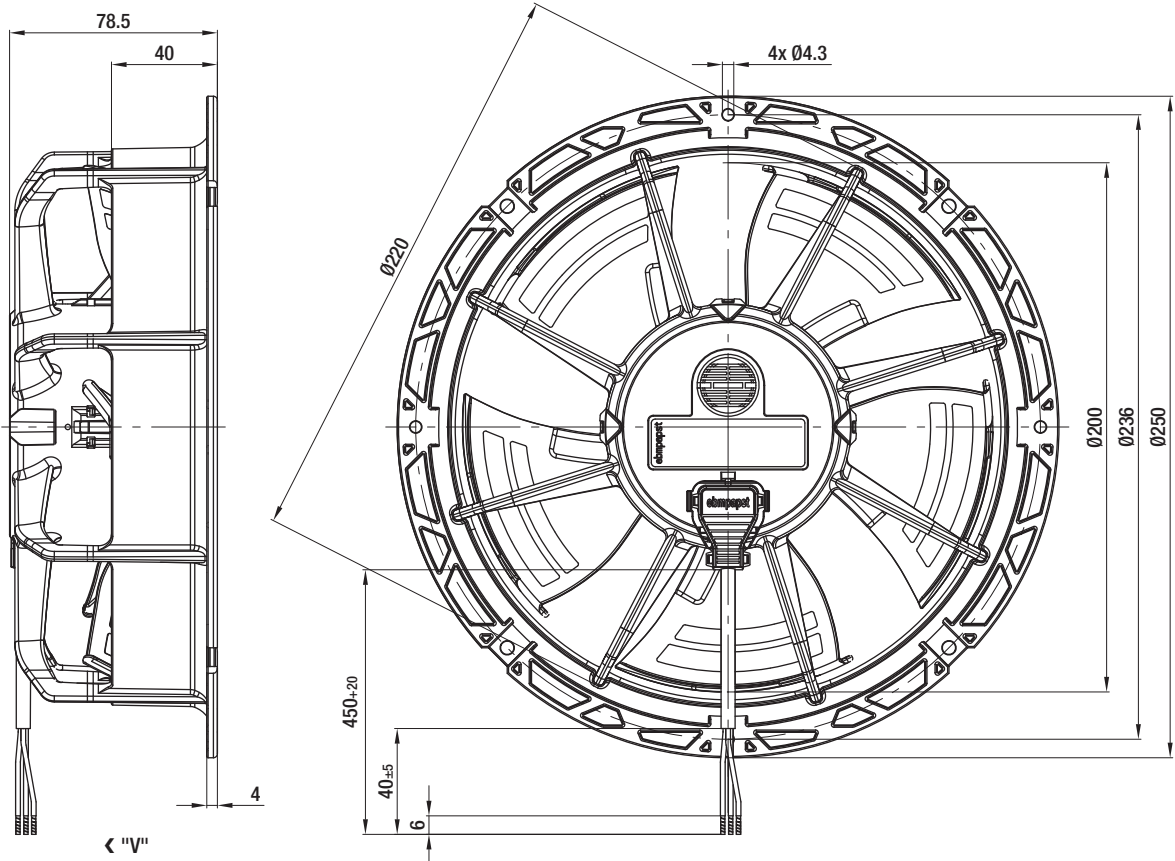
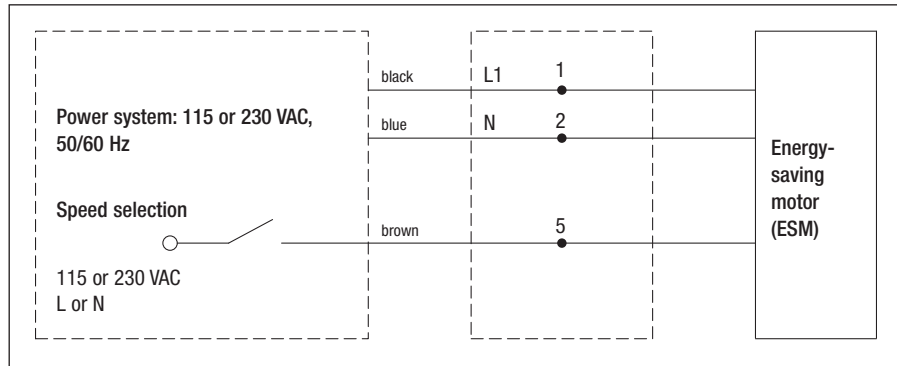

Energy-saving axial fans

Ø 200



- **Material:** Wall ring: Plastic PP
Blade: Plastic PA
- **Number of blades:** 5
- **Direction of air flow:** "V", exhaust over struts
- **Direction of rotation:** Counter-clockwise seen on rotor
- **Type of protection:** IP 54
- **Insulation class:** "B"
- **Mounting position:** Any
- **Condensate discharges:** None
- **Mode of operation:** Continuous operation (S1)
- **Bearings:** Maintenance-free ball bearings
- **Motor protection:** Via electronics and TOP
- **Electrical connection:** Line cord with plug
- **Protection class:** II
- **Product conforming to standard:** CE
- **Approvals:** VDE;
UL, CSA is applied for
- **Speed:** Using the programming unit, 2 speeds between n_{min} and n_{max} can be programmed.

Nominal data		Curve	Nominal voltage	Frequency	Speed ⁽¹⁾	Max. Power input ⁽¹⁾	Max. Current draw ⁽¹⁾	Max. operative range	Perm. amb. temp.	Mass
Type	Motor	VAC	Hz	rpm	W	A	Pa	°C	kg	
W1G200-EC95 -47	M1G 055-BD	A	115	50/60	2100	31	0,48	55	-30..+50	1,0
W1G200-EC91 -45	M1G 055-BD	B	230	50/60	2100	31	0,24	55	-30..+50	1,0

subject to alterations

⁽¹⁾ Nominal data in operating point with maximum load and 115 or 230 VAC

Curves

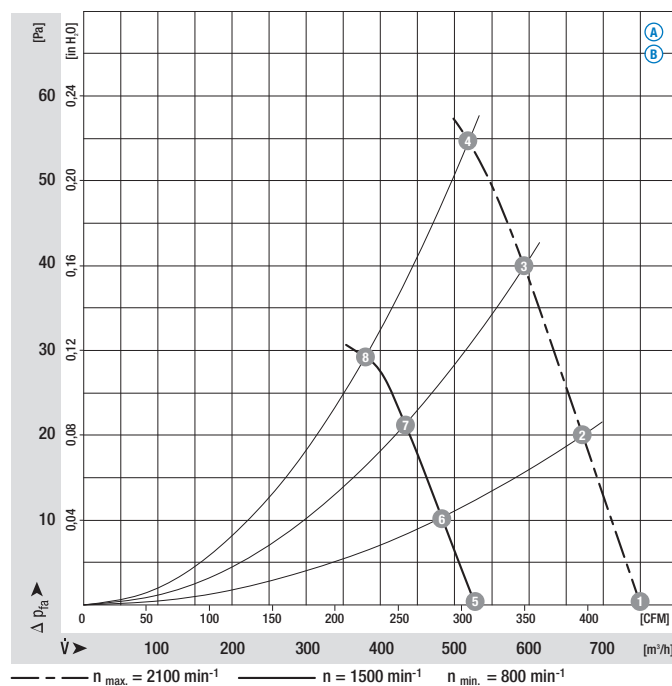

	n [rpm]	P ₁ [W]	I [A]	Lp _A [dB(A)]
A 1	2100	29	0,44	55
A 2	2100	30	0,46	54
A 3	2100	31	0,48	53
A 4	2100	31	0,48	55
A 5	1500	14	0,22	46
A 6	1500	16	0,24	45
A 7	1500	16	0,26	45
A 8	1500	16	0,26	46
B 1	2100	29	0,22	55
B 2	2100	30	0,23	54
B 3	2100	31	0,24	53
B 4	2100	31	0,24	55
B 5	1500	14	0,11	46
B 6	1500	16	0,12	45
B 7	1500	16	0,13	45
B 8	1500	16	0,13	46

– Electr. connection:

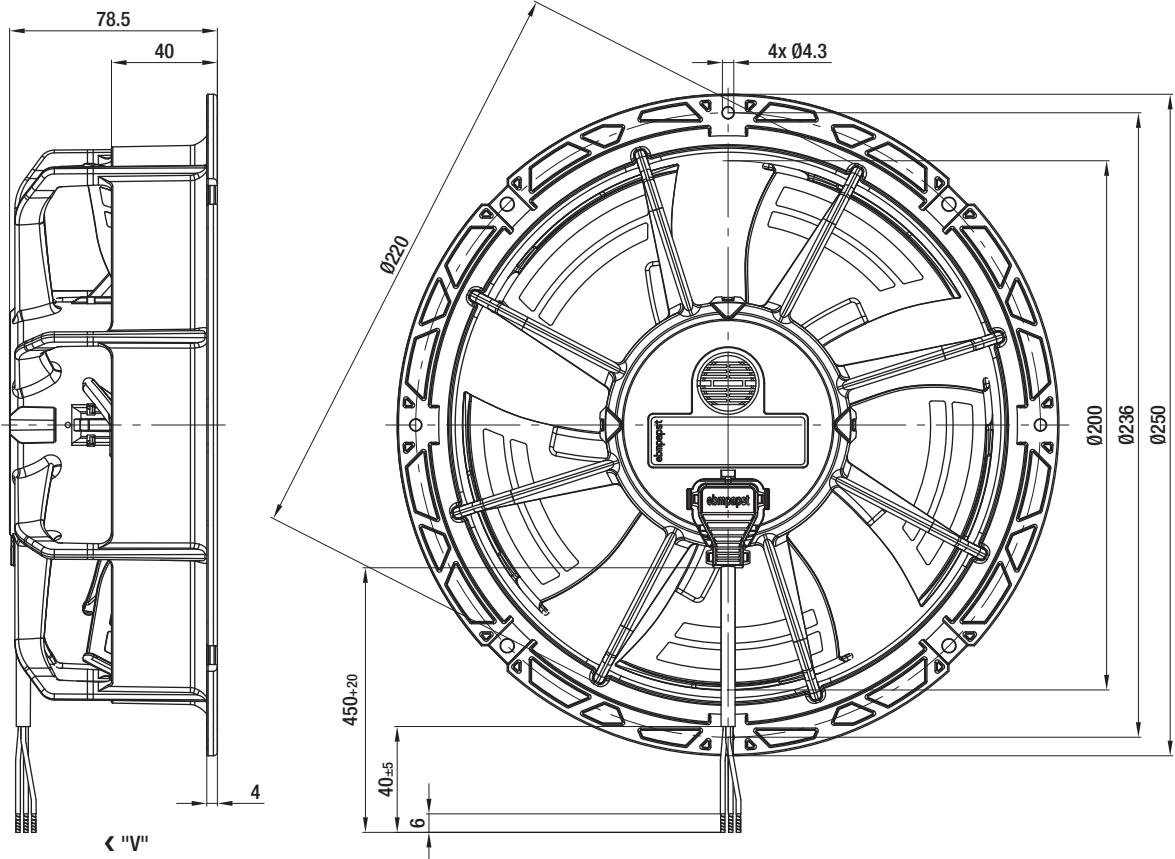

Energy-saving axial fans

Ø 200

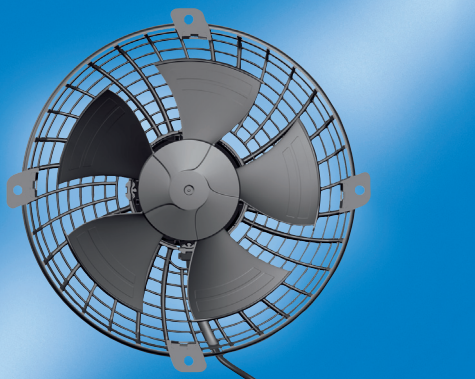

- **Material:** Blade: Plastic PA
Guard grille: Plastic PP
- **Number of blades:** 5
- **Direction of air flow:** "A", intake over guard grille
- **Direction of rotation:** Counter-clockwise seen on rotor
- **Type of protection:** IP 54
- **Insulation class:** "B"
- **Mounting position:** Any
- **Condensate discharges:** None
- **Mode of operation:** Continuous operation (S1)
- **Bearings:** Maintenance-free ball bearings
- **Motor protection:** Via electronics and TOP
- **Electrical connection:** Line cord with plug
- **Protection class:** II
- **Product conforming to standard:** CE
- **Approvals:** VDE; UL, CSA is applied for
- **Speed:** Using the programming unit, 2 speeds between n_{min} and n_{max} can be programmed.

Nominal data		Curve	Nominal voltage	Frequency	Speed ⁽¹⁾	Max. Power input ⁽¹⁾	Max. Current draw ⁽¹⁾	Max. operative range	Perm. amb. temp.	Mass
Type	Motor	VAC	Hz	rpm	W	A	Pa	°C	kg	
S1G 200-CA95 -02	M1G 055-BD	A	115	50/60	2000	31	0,43	45	-30..+50	0,95
S1G 200-CA91 -02	M1G 055-BD	B	230	50/60	2000	33,5	0,25	45	-30..+50	0,95

subject to alterations

⁽¹⁾ Nominal data in operating point with maximum load and 115 or 230 VAC

Curves

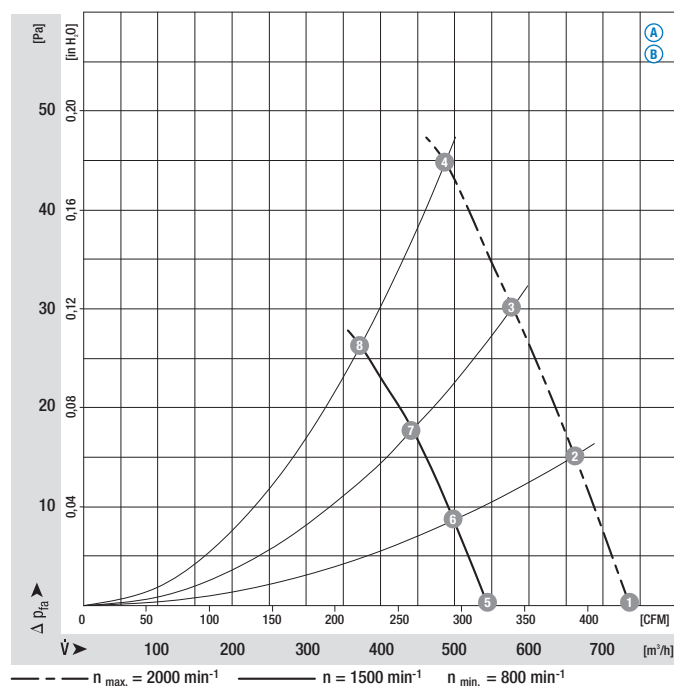

	n [rpm]	P ₁ [W]	I [A]	Lp _A [dB(A)]
A 1	2000	30	0,43	54
A 2	2000	30	0,43	54
A 3	2000	30	0,43	53
A 4	2000	31	0,43	54
A 5	1500	17	0,29	50
A 6	1500	18	0,29	50
A 7	1500	19	0,29	49
A 8	1500	20	0,29	50
B 1	2000	32	0,24	54
B 2	2000	33	0,25	54
B 3	2000	33	0,25	53
B 4	2000	33,5	0,25	54
B 5	1500	18	0,16	50
B 6	1500	19	0,16	50
B 7	1500	19	0,16	49
B 8	1500	20	0,16	50

– Electr. connection:

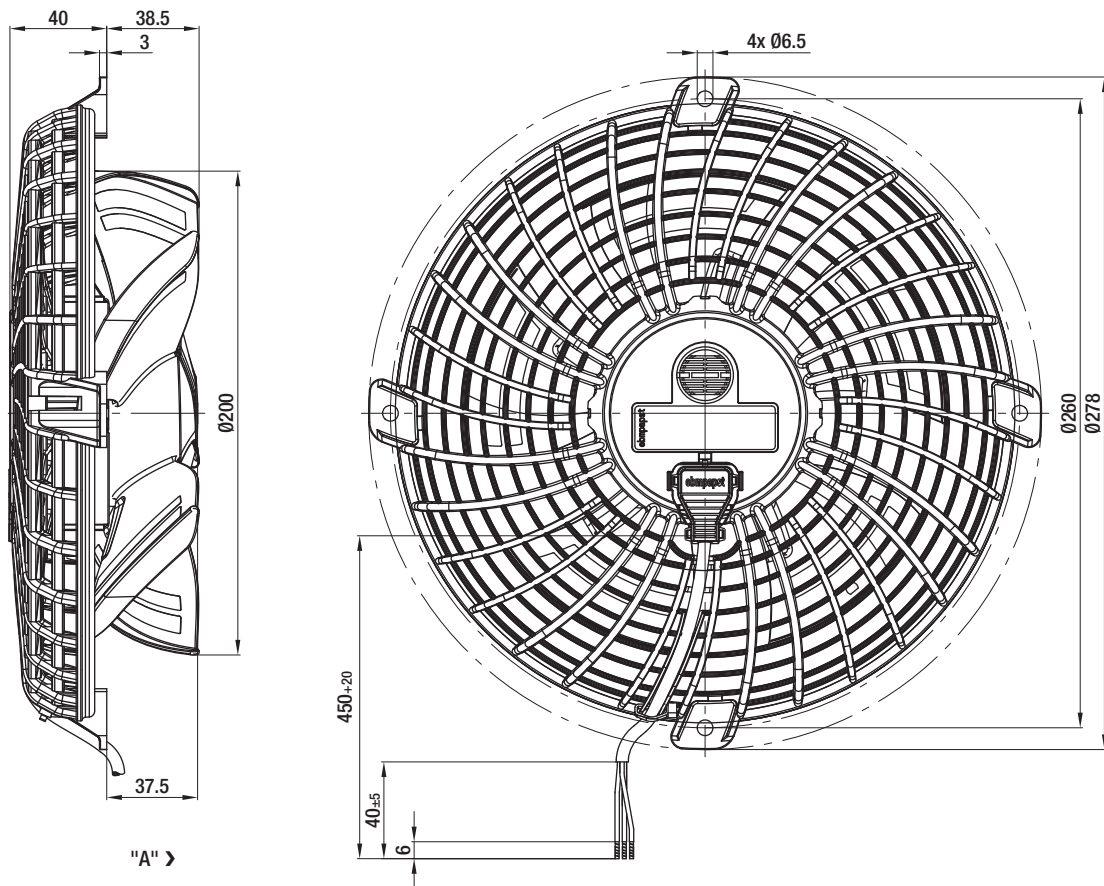
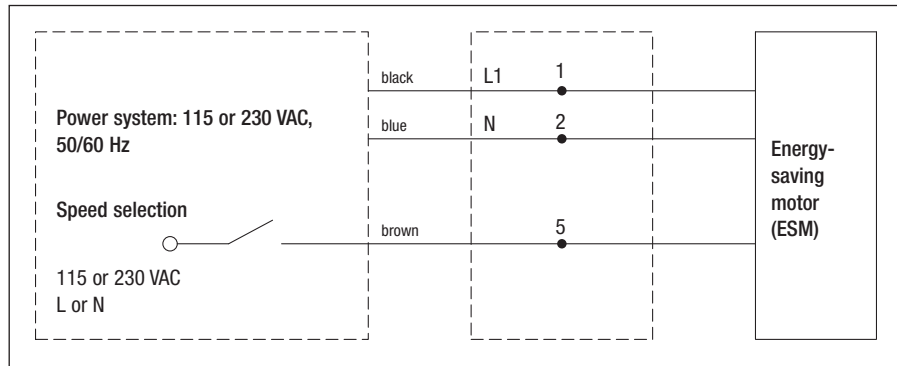

Energy-saving axial fans

Ø 230



- **Material:** Wall ring: Plastic PP
Blade: Plastic PA
- **Number of blades:** 5
- **Direction of air flow:** "V", exhaust over struts
- **Direction of rotation:** Counter-clockwise seen on rotor
- **Type of protection:** IP 54
- **Insulation class:** "B"
- **Mounting position:** Any
- **Condensate discharges:** None
- **Mode of operation:** Continuous operation (S1)
- **Bearings:** Maintenance-free ball bearings
- **Motor protection:** Via electronics and TOP
- **Electrical connection:** Line cord with plug
- **Protection class:** II
- **Product conforming to standard:** CE
- **Approvals:** VDE;
UL, CSA is applied for
- **Speed:** Using the programming unit, 2 speeds between n_{min} and n_{max} can be programmed.

Nominal data		Curve	Nominal voltage	Frequency	Speed ⁽¹⁾	Max. Power input ⁽¹⁾	Max. Current draw ⁽¹⁾	Max. operative range	Perm. amb. temp.	Mass
Type	Motor	VAC	Hz	rpm	W	A	Pa	°C	kg	
W1G230-EB97 -01	M1G 055-BD	A	115	50/60	1500	23	0,35	38	-30..+50	1,05
W1G230-EB89 -01	M1G 055-BD	B	230	50/60	1500	26	0,20	38	-30..+50	1,05

subject to alterations

⁽¹⁾ Nominal data in operating point with maximum load and 115 or 230 VAC

Curves

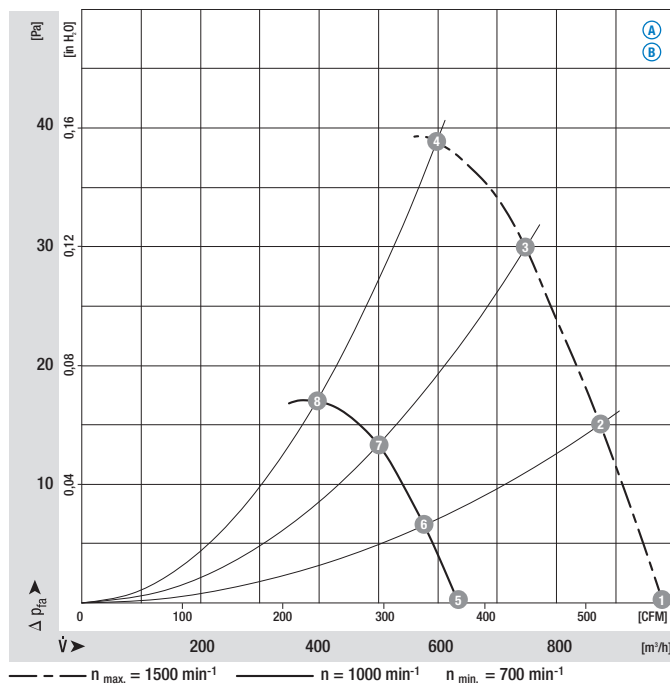

	n [rpm]	P ₁ [W]	I [A]	Lp _A [dB(A)]
A 1	1500	23	0,35	51
A 2	1500	23	0,35	51
A 3	1500	23	0,35	50
A 4	1500	23	0,35	50
A 5	1000	9	0,15	39
A 6	1000	10	0,16	39
A 7	1000	10	0,16	40
A 8	1000	10	0,16	40
B 1	1500	24	0,19	51
B 2	1500	25	0,19	51
B 3	1500	25	0,19	50
B 4	1500	26	0,20	50
B 5	1000	10	0,09	39
B 6	1000	11	0,09	39
B 7	1000	11	0,09	40
B 8	1000	11	0,09	40

– Electr. connection:

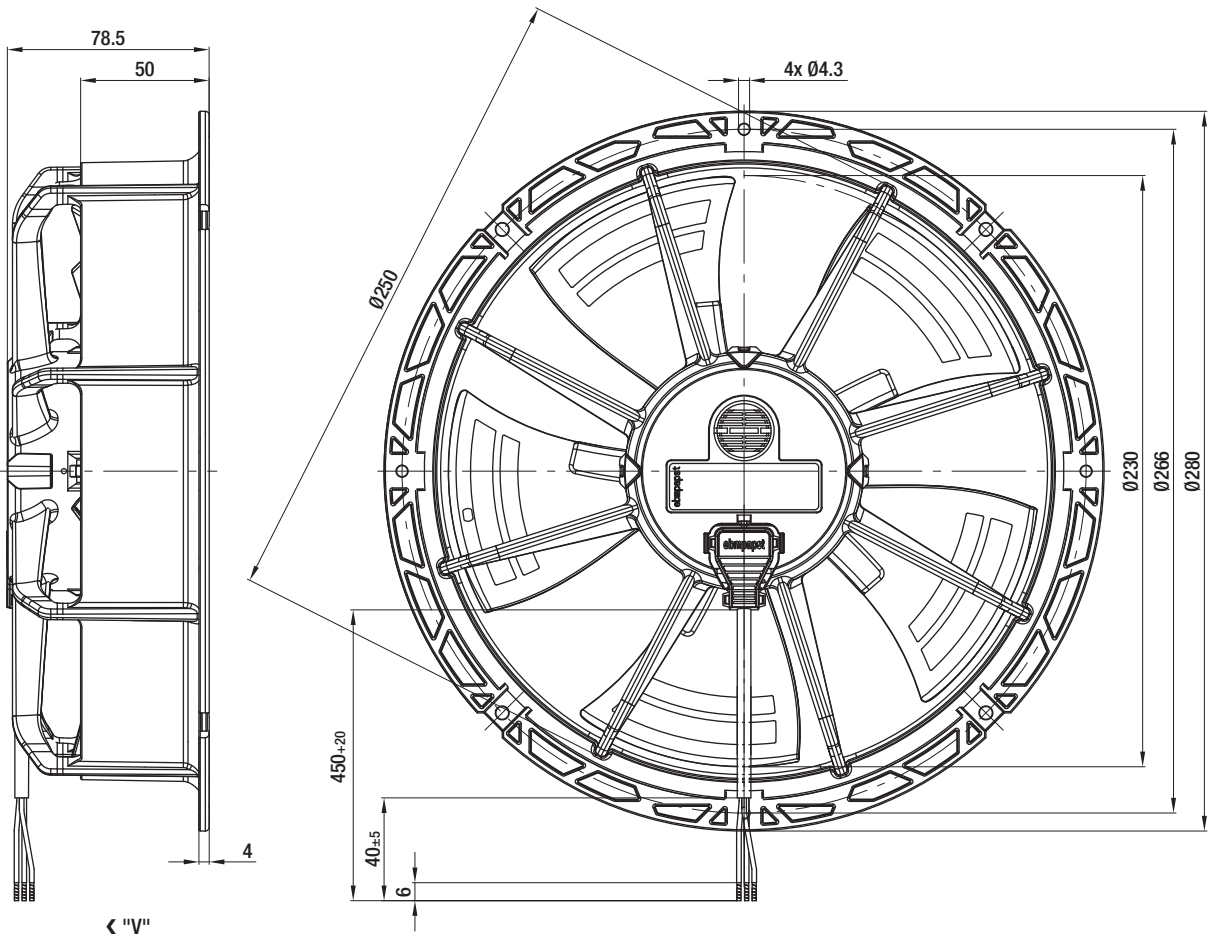
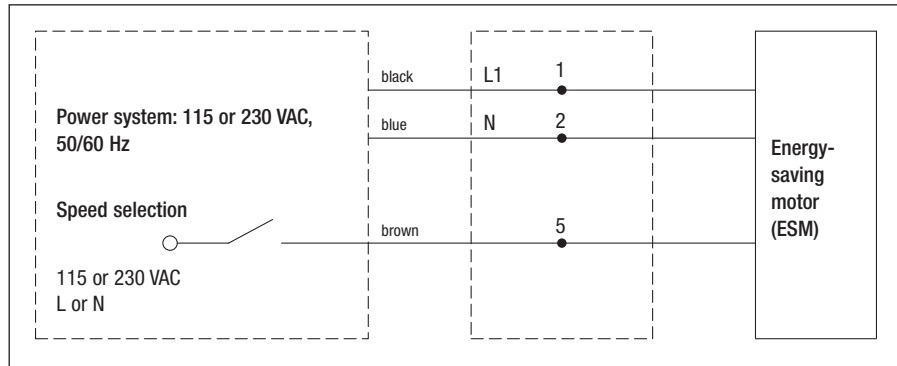

Energy-saving axial fans

Ø 250



- **Material:** Wall ring: Plastic PP
Blade: Plastic PA
- **Number of blades:** 5
- **Direction of air flow:** "V", exhaust over struts
- **Direction of rotation:** Counter-clockwise seen on rotor
- **Type of protection:** IP 54
- **Insulation class:** "B"
- **Mounting position:** Any
- **Condensate discharges:** None
- **Mode of operation:** Continuous operation (S1)
- **Bearings:** Maintenance-free ball bearings
- **Motor protection:** Via electronics and TOP
- **Electrical connection:** Line cord with plug
- **Protection class:** II
- **Product conforming to standard:** CE
- **Approvals:** VDE, UL, CSA is applied for
- **Speed:** Using the programming unit, 2 speeds between n_{min} and n_{max} can be programmed.

Nominal data		Curve	Nominal voltage	Frequency	Speed ⁽¹⁾	Max. Power input ⁽¹⁾	Max. Current draw ⁽¹⁾	Max. operative range	Perm. amb. temp.	Mass
Type	Motor	VAC	Hz	rpm	W	A	Pa	°C	kg	
W1G250-BB21 -01	M1G 055-BI	A	115	50/60	1700	32	0,47	42	-30..+50	1,55
W1G250-BB17 -01	M1G 055-BI	B	230	50/60	1700	32	0,24	42	-30..+50	1,55

subject to alterations

⁽¹⁾ Nominal data in operating point with maximum load and 115 or 230 VAC

Curves

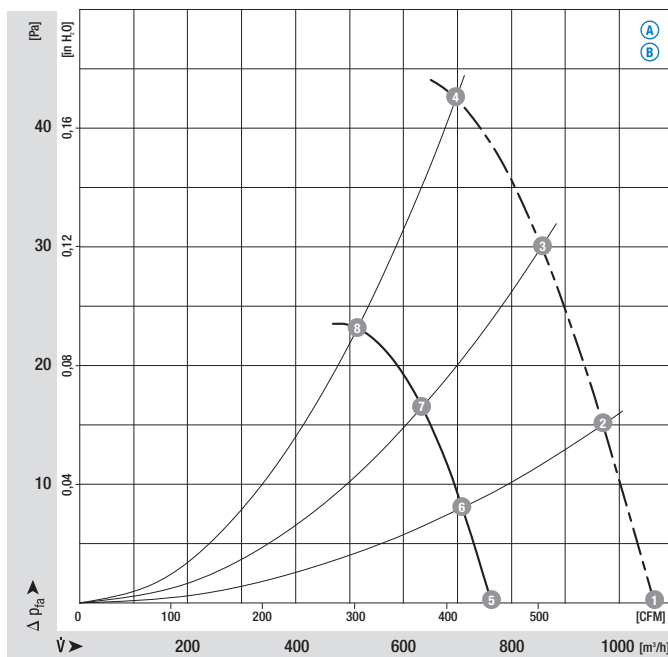

	n [rpm]	P ₁ [W]	I [A]	Lp _A [dB(A)]
A 1	1700	30	0,44	55
A 2	1700	31	0,45	56
A 3	1700	32	0,47	56
A 4	1700	32	0,47	57
A 5	1200	14	0,22	46
A 6	1200	15	0,24	46
A 7	1200	16	0,25	47
A 8	1200	17	0,26	48
B 1	1700	30	0,24	55
B 2	1700	31	0,24	56
B 3	1700	32	0,24	56
B 4	1700	32	0,24	57
B 5	1200	14	0,12	46
B 6	1200	15	0,13	46
B 7	1200	16	0,14	47
B 8	1200	17	0,14	48

– Electr.
connection:

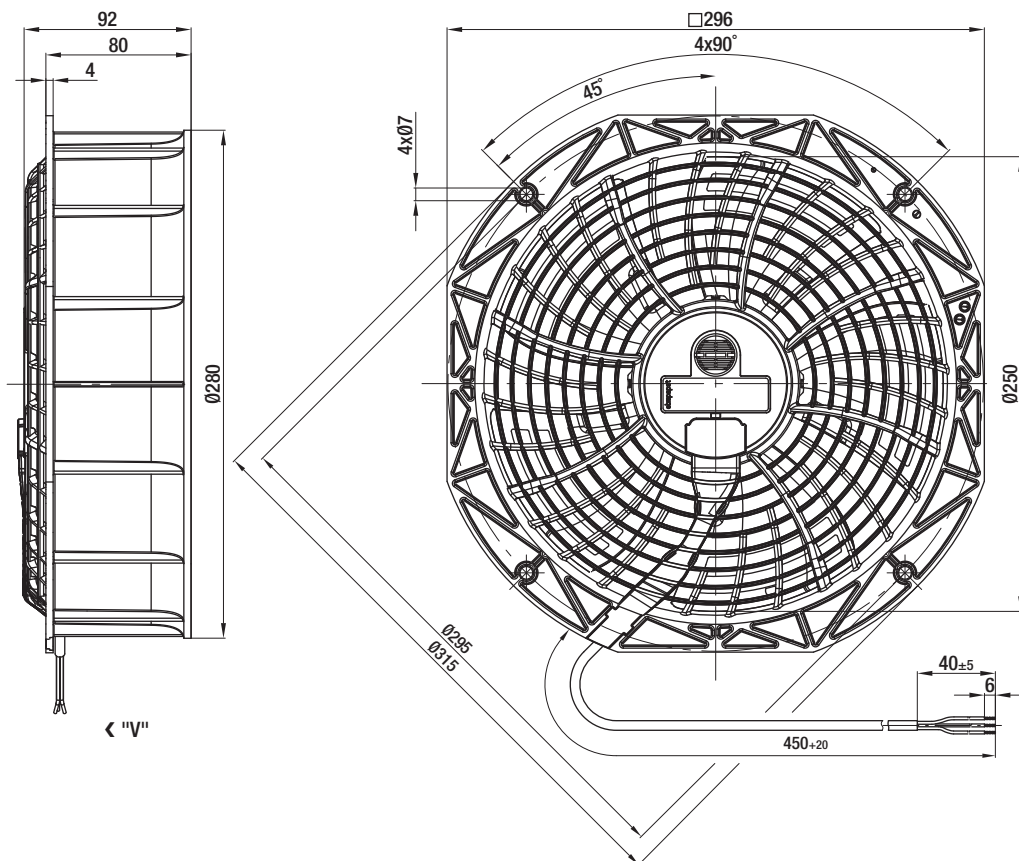
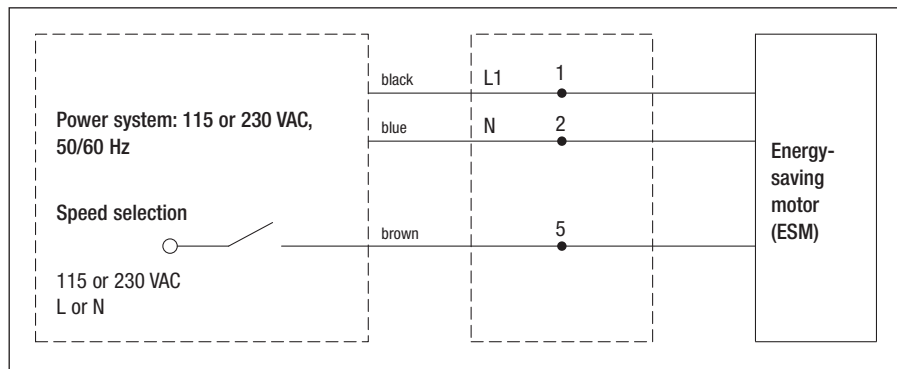

Energy-saving axial fans

Ø 300



- **Material:** Wall ring: Plastic PP
Blade: Plastic PA
- **Number of blades:** 5
- **Direction of air flow:** "V", exhaust over struts
- **Direction of rotation:** Counter-clockwise seen on rotor
- **Type of protection:** IP 54
- **Insulation class:** "B"
- **Mounting position:** Any
- **Condensate discharges:** None
- **Mode of operation:** Continuous operation (S1)
- **Bearings:** Maintenance-free ball bearings
- **Motor protection:** Via electronics and TOP
- **Electrical connection:** Line cord with plug
- **Protection class:** II
- **Product conforming to standard:** CE
- **Approvals:** VDE, UL, CSA is applied for
- **Speed:** Using the programming unit, 2 speeds between n_{min} and n_{max} can be programmed.

Nominal data		Curve	Nominal voltage	Frequency	Speed ⁽¹⁾	Max. Power input ⁽¹⁾	Max. Current draw ⁽¹⁾	Max. operative range	Perm. amb. temp.	Mass
Type	Motor	VAC	Hz	rpm	W	A	Pa	°C	kg	
W1G300-BB23 -01	M1G 055-BI	A	115	50/60	1300	35	0,50	35	-30..+50	1,75
W1G300-BB19 -01	M1G 055-BI	B	230	50/60	1300	35	0,27	35	-30..+50	1,75

subject to alterations

⁽¹⁾ Nominal data in operating point with maximum load and 115 or 230 VAC

Curves

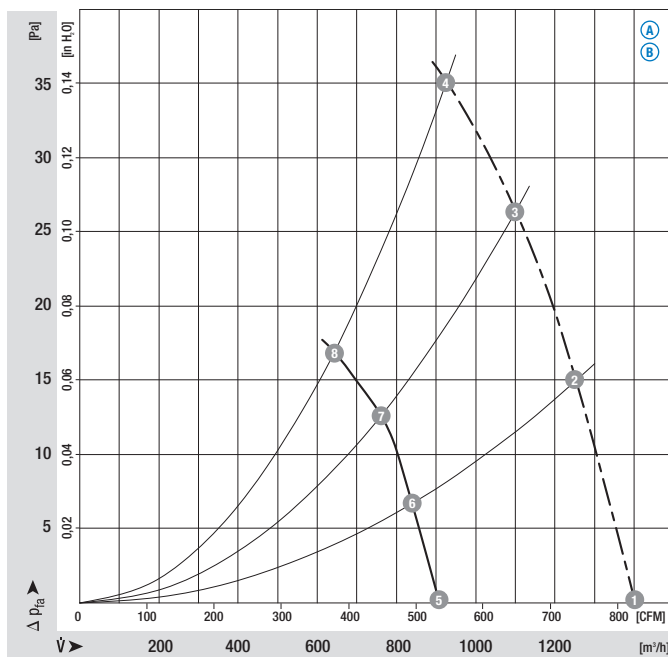

	n [rpm]	P ₁ [W]	I [A]	Lp _A [dB(A)]
A 1	1300	28	0,41	52
A 2	1300	31	0,46	52
A 3	1300	32	0,47	51
A 4	1300	35	0,50	52
A 5	900	12	0,24	43
A 6	900	14	0,26	42
A 7	900	15	0,28	42
A 8	900	16	0,30	43
B 1	1300	32	0,25	52
B 2	1300	34	0,27	52
B 3	1300	34	0,27	51
B 4	1300	35	0,27	52
B 5	900	13	0,12	43
B 6	900	14	0,13	42
B 7	900	15	0,14	42
B 8	900	16	0,15	43

- Electr. connection:

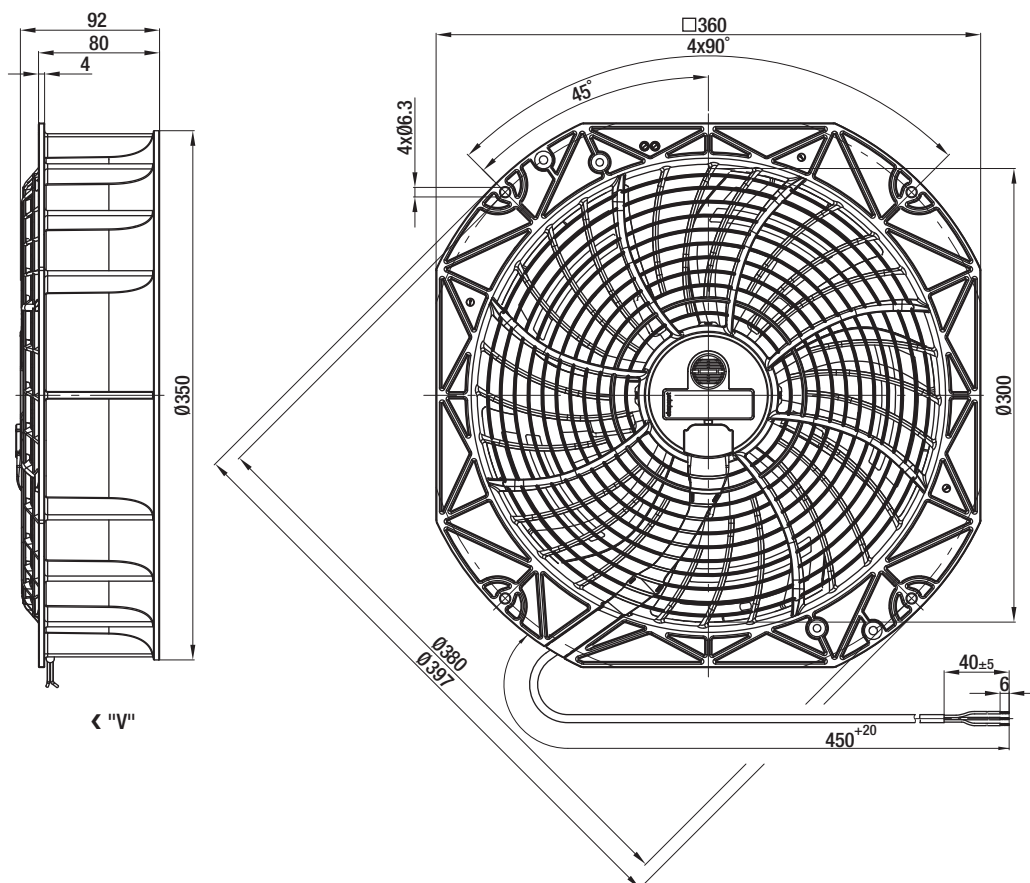
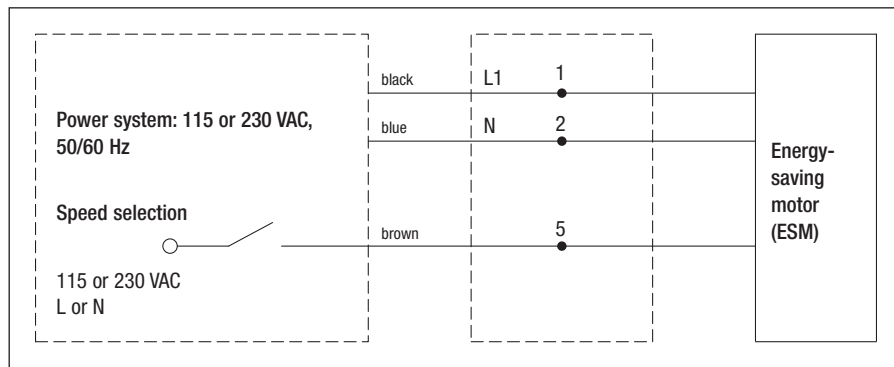

Energy-saving axial fans

Ø 300

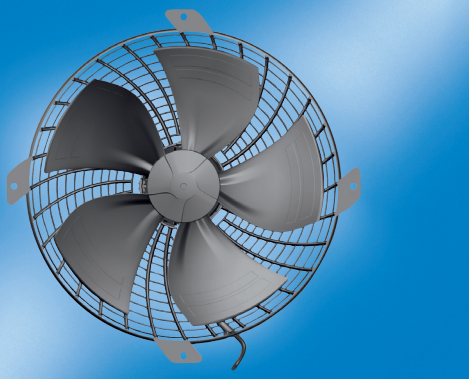

- **Material:** Blade: Plastic PA
Guard grille: Plastic PP
- **Number of blades:** 5
- **Direction of air flow:** "A", intake over guard grille
- **Direction of rotation:** Counter-clockwise seen on rotor
- **Type of protection:** IP 54
- **Insulation class:** "B"
- **Mounting position:** Any
- **Condensate discharges:** None
- **Mode of operation:** Continuous operation (S1)
- **Bearings:** Maintenance-free ball bearings
- **Motor protection:** Via electronics and TOP
- **Electrical connection:** Line cord with plug
- **Protection class:** II
- **Product conforming to standard:** CE
- **Approvals:** VDE, UL, CSA is applied for
- **Speed:** Using the programming unit, 2 speeds between n_{min} and n_{max} can be programmed.

Nominal data		Curve	Nominal voltage	Frequency	Speed ⁽¹⁾	Max. Power input ⁽¹⁾	Max. Current draw ⁽¹⁾	Max. operative range	Perm. amb. temp.	Mass
Type	Motor	VAC	Hz	rpm	W	A	Pa	°C	kg	
S1G 300-CA23 -02	M1G 055-BI	A	115	50/60	1200	35	0,56	40	-30..+50	1,4
S1G 300-CA19 -02	M1G 055-BI	B	230	50/60	1200	35	0,28	40	-30..+50	1,4

subject to alterations

⁽¹⁾ Nominal data in operating point with maximum load and 115 or 230 VAC

Curves

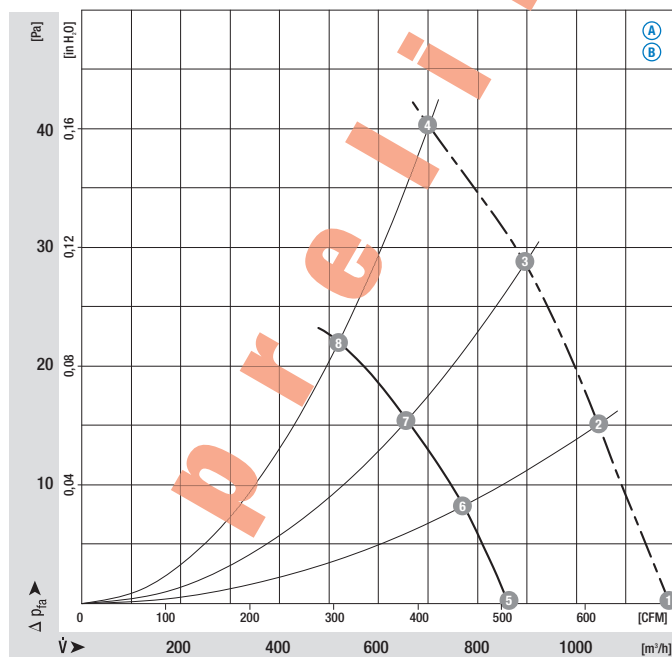

	n [rpm]	P ₁ [W]	I [A]	Lp _A [dB(A)]
A 1	1200	24	0,40	54
A 2	1200	27	0,44	53
A 3	1200	31	0,50	54
A 4	1200	35	0,56	54
A 5	900	16	0,30	51
A 6	900	18	0,34	50
A 7	900	19	0,36	49
A 8	900	21	0,40	49
B 1	1200	24	0,20	54
B 2	1200	27	0,22	53
B 3	1200	31	0,25	54
B 4	1200	35	0,28	54
B 5	900	16	0,15	51
B 6	900	18	0,17	50
B 7	900	19	0,18	49
B 8	900	21	0,20	49

– Electr.
connection:

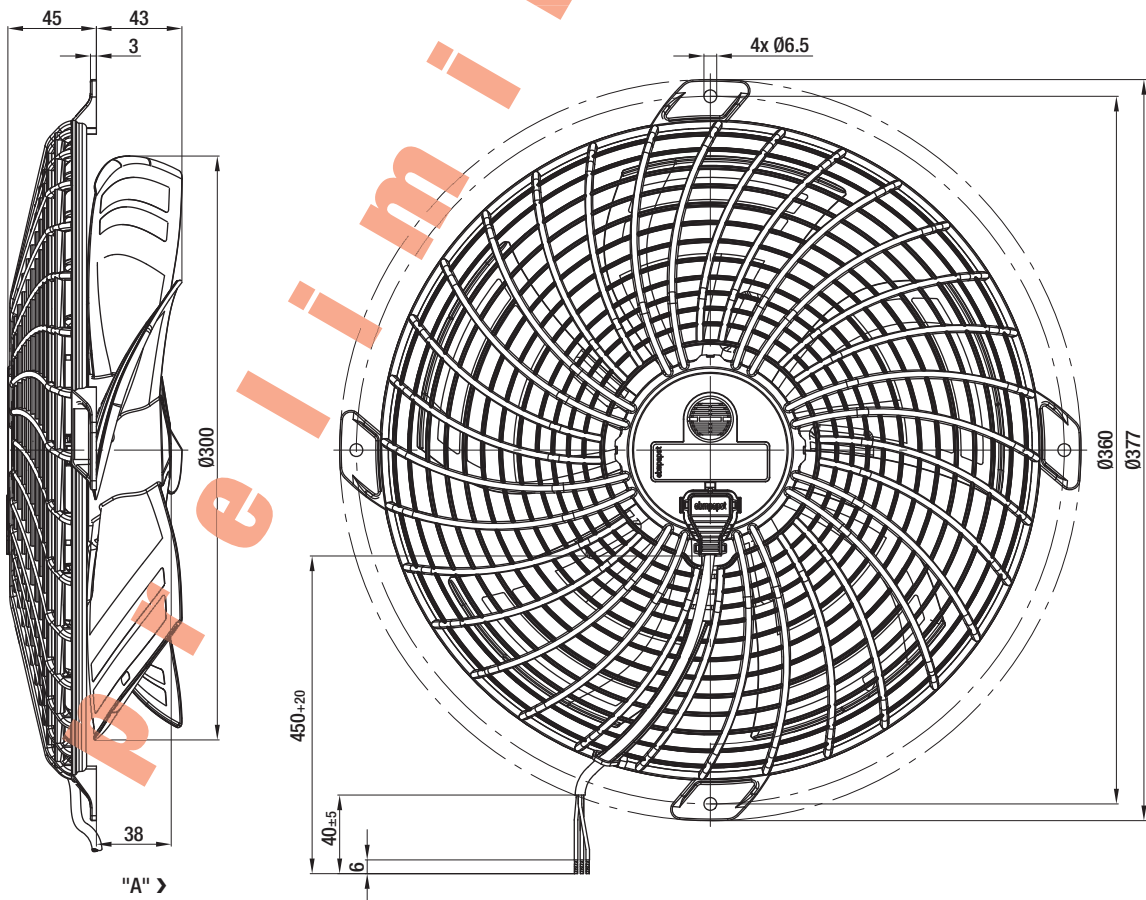
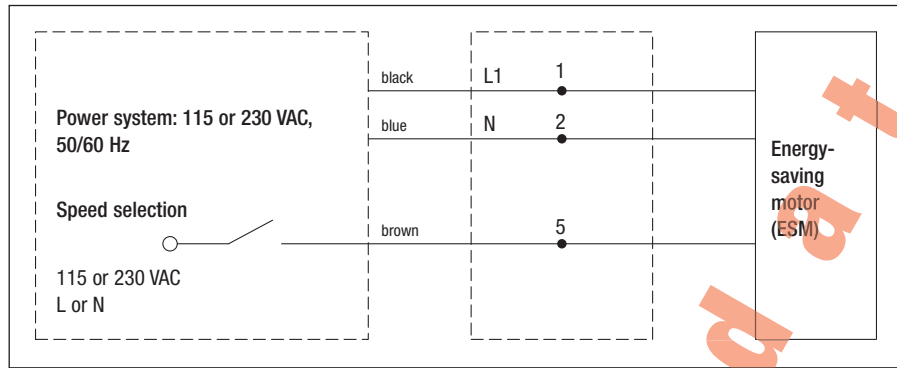

Connection leads

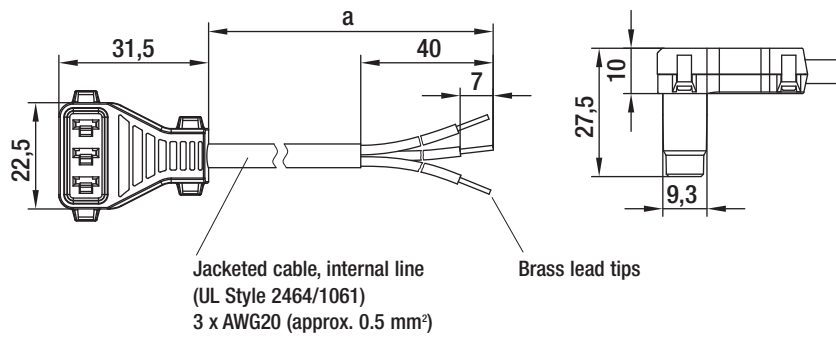

- **Design:** Cable conforms to UL standards, sealed plug

Connection lines for energy-saving motors (ESM)

Part no.	a
10637-4-1040	450
10640-4-1040	600
10638-4-1040	1500
10639-4-1040	2000

subject to alterations

-  fan agent
-  compact fan agent
-  motor specialist
-  motor agent

ebm-papst representatives & subsidiaries

Germany

ebm-papst Muldingen GmbH & Co. KG

Bachmühle 2
D-74673 Muldingen
Phone +49 (0) 79 38 / 81-0
Fax +49 (0) 79 38 / 81-110
info1@de.ebmpapst.com

www.ebmpapst.com

ebm-papst St. Georgen GmbH & Co. KG

Hermann-Papst-Straße 1
D-78112 St. Georgen
Phone +49 (0) 77 24 / 81-0
Fax +49 (0) 77 24 / 81-13 09
info2@de.ebmpapst.com

www.ebmpapst.com





















ebm-papst Landshut GmbH

Hofmark-Aich-Straße 25
D-84030 Landshut
Phone +49 (0) 8 71 / 707-0
Fax +49 (0) 8 71 / 707-465
info3@de.ebmpapst.com

www.ebmpapst.com

Agencies

-  **Berlin**
 Dipl.-Ing. (TH) Jens Duchow
 Händelstraße 7
D-16341 Panketal
Phone +49 (0) 30 / 94 41 49 62
Fax +49 (0) 30 / 94 41 49 63
Jens.Duchow@de.ebmpapst.com
-  **Bielefeld**
 Dipl.-Ing. (FH) Wolf-Jürgen Weber
 Niehausweg 13
D-33739 Bielefeld
Phone +49 (0) 52 06 / 9 17 32 31
Fax +49 (0) 52 06 / 9 17 32 35
Wolf-Juergen.Weber@de.ebmpapst.com
-  **Dortmund**
 Dipl.-Ing. (FH) Hans-Joachim Pundt
 Auf den Steinern 3
D-59519 Möhnesee-Völlinghausen
Phone +49 (0) 29 25 / 80 04 07
Fax +49 (0) 29 25 / 80 04 08
Hans-Joachim.Pundt@de.ebmpapst.com
-  **Frankfurt**
 Dipl.-Ing. Christian Kleffmann
 Dr.-Hermann-Krause-Straße 23
D-63452 Hanau
Phone +49 (0) 61 81 / 18 98 12
Fax +49 (0) 61 81 / 18 98 13
Christian.Kleffmann@de.ebmpapst.com
-  **Halle**
 Dipl.-Ing. (TU) Michael Hanning
 Lerchenweg 4
D-06120 Lieskau
Phone +49 (0) 3 45 / 5 51 24 56
Fax +49 (0) 3 45 / 5 51 24 57
Michael.Hanning@de.ebmpapst.com
-  **Hamburg**
 Ingenieurbüro Breuell GmbH
 Ing. Dirk Kahl
Elektroingenieur
Grützmühlenweg 40
D-22339 Hamburg
Phone +49 (0) 40 / 53 80 92 55
Fax +49 (0) 40 / 53 80 92 84
Dirk.Kahl@de.ebmpapst.com

-  **Kassel**
 Dipl.-Ing. (FH) Ralph Brück
 Hoherainstraße 38
D-35075 Gladenbach
Phone +49 (0) 64 62 / 40 71 10
Fax +49 (0) 64 62 / 40 71 11
Ralph.Brueck@de.ebmpapst.com
-  **Koblenz**
 Winfried Schaefer
 Hinter der Kirch 10
D-56767 Uersfeld
Phone +49 (0) 26 57 / 16 96
Fax +49 (0) 26 57 / 16 76
Winfried.Schaefer@de.ebmpapst.com
-  **Munich**
 Dipl.-Wirtsch.-Ing. (FH) Jens Peter
 Steinbergweg 6
D-82285 Hattenhofen
Phone +49 (0) 81 45 / 80 92 25
Fax +49 (0) 81 45 / 80 92 26
Jens.Peter@de.ebmpapst.com
-  **Nuremberg**
 Friedrich Klein
 Adlerstraße 49/1
D-73540 Heubach
Phone +49 (0) 71 73 / 49 83
Fax +49 (0) 71 73 / 80 53
Friedrich.Klein@de.ebmpapst.com
-  **Offenburg**
 Dipl.-Ing. (FH) Ralf Braun
 Hubeneck 21
D-77704 Oberkirch
Phone +49 (0) 78 02 / 98 22 52
Fax +49 (0) 78 02 / 98 22 53
Ralf.Braun@de.ebmpapst.com
-  **Stuttgart**
 Dipl.-Ing. (FH) Rudi Weinmann
 Hindenburgstraße 100/1
D-73207 Plochingen
Phone +49 (0) 71 53 / 92 89 80
Fax +49 (0) 71 53 / 92 89 81
Rudi.Weinmann@de.ebmpapst.com
-  **Ulm**
 Günter Wilhelm
 Allgäuer Straße 7
D-89269 Vöhringen
Phone +49 (0) 73 06 / 92 46 08
Fax +49 (0) 73 06 / 92 46 48
Gunter.Wilhelm@de.ebmpapst.com

Distributors

-  **Frankfurt**
 R.E.D. Handelsgesellschaft mbH
 Gutenbergstraße 3
D-63110 Rodgau - Jügesheim
Phone +49 (0) 61 06 / 84 10
Fax +49 (0) 61 06 / 84 11 11
info@red-elektromechanik.de
www.red-elektromechanik.de
-  **Hamburg**
 Breuell + Hilgenfeldt GmbH
 Grützmühlenweg 40
D-22339 Hamburg
Phone +49 (0) 40 / 53 80 92 20
Fax +49 (0) 40 / 53 80 92 84
info@breuell-hilgenfeldt.de
-  **Munich**
 A. Schweiger GmbH
 Ohmstraße 1
D-82054 Sauerlach
Phone +49 (0) 81 04 / 8 97 0
Fax +49 (0) 81 04 / 8 97 90
info@schweiger-gmbh.de
www.schweiger-gmbh.com
- **Express Service-Center** (1 to 5 pieces)
-  **North**
 Breuell + Hilgenfeldt GmbH
 Grützmühlenweg 40
D-22339 Hamburg
Phone +49 (0) 40 / 53 80 92 20
Fax +49 (0) 40 / 53 80 92 84
ebmpapst@breuell-hilgenfeldt.de
-  **South**
 HDS Ventilatoren Vertriebs GmbH
 Glaswiesenstraße 1
D-74677 Dörzbach
Phone +49 (0) 79 37 / 80 29 68
Fax +49 (0) 79 37 / 80 25 78
info@hds-gmbh.net

Europe

 **Austria**
 ebm-papst Motoren & Ventilatoren GmbH
 Westbahnstraße 5
A-4490 St. Florian
Phone +43 / 72 24 / 66 01 10
Fax +43 / 72 24 / 66 01 120
info@at.ebmpapst.com
www.ebmpapst.at

 **Belarus**
 ebm-papst Bel AgmbH
 Prospekt Nesavisimosti 11/2 office 325, 512
BY-220050 Minsk
Phone +375 / 17 / 209 95 61
Fax +375 / 17 / 209 95 61
info@by.ebmpapst.com
www.ebmpapst.by

 **Belgium**
 VIBO Benelux B. V.
 Sales office Belgium-Luxemburg
Romeinsestraat 6/0101
Research Park Haasrode
B-3001 Heverlee-Leuven
Phone +32 / 16 / 39 62 00
Fax +32 / 16 / 39 62 20
info@vibobenelux.com
www.vibobenelux.com

 **Bulgaria**
 ebm-papst Romania S.R.L.
 Str. Tirnavei Nr. 20
RO-500327 Brasov
Phone +40 / 268 / 312 805
Fax +40 / 268 / 312 805
dudasludovic@xnet.ro

 **Croatia**
 ebm-papst Industries Kft.
 Ezred u. 2.
H-1044 Budapest
Phone +36 / 1 / 87 22 190
Fax +36 / 1 / 87 22 194
office@hu.ebmpapst.com
www.ebmpapst.hu



 **Cyprus**
 MATERO LTD
 37, St. Kyriakides Avenue
P.O. Box 51744
CY-3080 Limassol
Phone +357 / 25 / 87 00 30
Fax +357 / 25 / 38 13 66
matero@cytanet.com.cy
www.matero.com.cy

 **Czech Republic / Slovakia**
 ebm-papst CZ s.r.o.
 Krátká 379
CZ-66461 Rajhradice u Brna
Phone +420 / 547 / 232 617
Fax +420 / 547 / 232 622
info@ebmpapst.cz
www.ebmpapst.cz

 **Denmark**
 Jenk A/S
 Vallensbækvej 21
DK-2605 Brøndby
Phone +45 / 43 / 63 11 11
Fax +45 / 43 / 63 05 05
jenk@jenk.dk
www.jenk.dk

 **Estonia**
 ebm-papst Oy Eesti Filiaal
 Kadaka tee 3
EST-10621 Tallinn
Phone +372 / 65 56 / 978
Fax +372 / 65 56 / 979
www.ebmpapst.ee

 **Finland**
 ebm-papst Oy
 Puistotie 1
FIN-02760 Espoo
Phone +358 / 9 / 88 70 22 0
Fax +358 / 9 / 88 70 22 13
mailbox@ebmpapst.fi
www.ebmpapst.fi

 **France**
 ebm-papst SARL
 ZI Nord - rue A. Mohler
BP 62
F-67212 Obernai-Cedex
Phone +33 / 820 326 266
Fax +33 / 3 / 88 67 38 83
info@ebmpapst.fr
www.ebmpapst.fr

 **Greece**
 Helcoma
 Th. Rotas & Co OE
Davaki 65
GR-17672 Kallithea-Attiki
Phone +30 / 210 / 951 37 05
Fax +30 / 210 / 951 34 90
contact@helcoma.gr
www.helcoma.gr





 **Hungary**
 ebm-papst Industries Kft.
 Ezred u. 2.
H-1044 Budapest
Phone +36 / 1 / 87 22 190
Fax +36 / 1 / 87 22 194
office@hu.ebmpapst.com
www.ebmpapst.hu

 **Iceland**
 RJ Engineers
 Stangarhyl 1A
IS-110 Reykjavik
Phone +354 / 567 80 30
Fax +354 / 567 80 15
rj@rj.is
www.rj.is

 **Ireland**
 ebm-papst Limited
 Portlaoise Business & Technology Park
Mountrath Road
IRL-Portlaoise, Co. Laois
Phone +353 / 57 86 / 643 43
Fax +353 / 57 86 / 643 46
sales@ie.ebmpapst.com
www.ebmpapst.ie





 **Italy**
 ebm-papst Srl
 Via Cornaggia 108
I-22076 Mozzate (Co)
Phone +39 / 03 31 / 83 62 01
Fax +39 / 03 31 / 82 15 10
info@it.ebmpapst.com
www.ebmpapst.it

 **Macedonia**
 ebm-papst Industries Kft.
 Ezred u. 2.
H-1044 Budapest
Phone +36 / 1 / 87 22 190
Fax +36 / 1 / 87 22 194
office@hu.ebmpapst.com
www.ebmpapst.hu

-  fan agent
-  compact fan agent
-  motor specialist
-  motor agent

ebm-papst representatives & subsidiaries





 **Netherlands**
 VIBO Benelux B. V.
 Engelseweg 127
 Postbus 230
 NL-5705 AC Helmond
 Phone +31 / 4 92 / 50 29 00
 Fax +31 / 4 92 / 50 29 50
verkoop@vibobnelux.com
www.vibobnelux.com

 **Norway**
 ebm-papst AS
 P.B. 173 Holmlia
 N-1203 Oslo
 Phone +47 / 22 / 76 33 40
 Fax +47 / 22 / 61 91 73
mailbox@ebmpapst.no
www.ebmpapst.no





 **Poland**
 ebm-papst Polska Sp. z o.o.
 ul. Annopol 4A
 PL-03236 Warszawa
 Phone +48 / 22 / 675 78 19
 Fax +48 / 22 / 676 95 87
office@ebmpapst.pl
www.ebmpapst.pl

 **Portugal**
 ebm-papst (Portugal), Lda.
 Av. Marechal Gomes da Costa, 35 e
 Rua Conselheiro Emidio Navarro
 P-1800-255 Lisboa
 Phone +351 / 218 / 394 880
 Fax +351 / 218 / 394 759
info@pt.ebmpapst.com
www.ebmpapst.pt

 **Romania**
 ebm-papst Romania S.R.L.
 Str. Tirnavei Nr. 20
 RO-500327 Brasov
 Phone +40 / 268 / 312 805
 Fax +40 / 268 / 312 805
dudasludovic@xnet.ro

 **Russia**
 ebm-papst Ural GmbH
 Posadskaja-Strasse, 23(E), 3
 RU-620102 Ekaterinburg
 Phone +7 / 343 / 233 80 00
 Fax +7 / 343 / 233 77 88
Konstantin.Molokov@ru.ebmpapst.com
www.ebmpapst.ur.ru

 ebm-papst Rus GmbH
 Nizhegorodskaya 32, str. 15 office 420
 RU-109029 Moskau
 Phone +7 / 495 / 671 53 93
 Fax +7 / 495 / 671 53 95
info@ebmpapst.ru
www.ebmpapst.ru

 ebm-papst Rus
 Saint-Petersburg's Filial
 Zastavskaya 7
 RU-196084 Sankt-Petersburg
 Phone +7 / 812 / 449 96 07
 Fax +7 / 812 / 449 96 07
spb@ru.ebmpapst.com



 **Serbia & Montenegro**
 ebm-papst Industries Kft.
 Ezred u. 2.
 H-1044 Budapest
 Phone +36 / 1 / 87 22 190
 Fax +36 / 1 / 87 22 194
office@hu.ebmpapst.com
www.ebmpapst.hu

 **Spain**
 ebm-papst Ibérica S.L.
 Avda. del Sistema Solar, 29
 E-28830 San Fernando de Henares (Madrid)
 Phone +34 / 91 / 678 08 94
 Fax +34 / 91 / 678 15 30
ventas@ebmpapst.es

 **Sweden**
 ebm-papst AB
 Äggelundavägen 2
 S-17562 Järfälla
 Phone +46 / 8 / 761 94 00
 Fax +46 / 8 / 36 23 06
info@ebmpapst.se
www.ebmpapst.se

 **Switzerland**
 ebm-papst AG
 Rütisbergstrasse 1
 CH-8156 Oberhasli
 Phone +41 / 44 / 732 20 70
 Fax +41 / 44 / 732 20 77
verkauf@ebmpapst.ch
www.ebmpapst.ch

 **Turkey**
 Akantel Elektronik San. Tic. LTD. Sti.
 Atatürk Organize Sanayi
 Bölgesi 10007 SK. No.:6
 TR-35620 Cigli-Izmir
 Phone +90 / 232 / 328 20 90
 Fax +90 / 232 / 328 02 70
akantel@akantel.com.tr
www.ebmpapst.com.tr

 **Ukraine**
 ebm-papst Ukraine LLC
 Lapse Boulevard, 4, Building 47
 UA-03067 Kiev
 Phone +38 / 044 / 206 30 91
 Fax +38 / 044 / 206 30 91
mail@ebmpapst.ua
www.ebmpapst.ua

 **United Kingdom**
 ebm-papst UK Ltd.
 Chelmsford Business Park
 GB-Chelmsford Essex CM2 5EZ
 Phone +44 / 12 45 / 46 85 55
 Fax +44 / 12 45 / 46 63 36
sales@uk.ebmpapst.com
www.ebmpapst.co.uk

 ebm-papst Automotive & Drives (UK) Ltd.
 The Smithy
 Fidlers Lane, East Ilsley
 GB-Berkshire RG20 7LG
 Phone +44 / 87 07 / 66 51 70
 Fax +44 / 87 07 / 66 51 80
A&Dsales@uk.ebmpapst.com
www.ebmpapst-ad.com

America



Argentina



ebm-papst de Argentina S.A.
Hernandarias 148 Lomas del Mirador
Pcia. de Buenos Aires (1752)
Phone +54 / 11 46 57 61 35
Fax +54 / 11 46 57 20 92
ventas@ar.ebmpapst.com
www.ebmpapst.com.ar



Brasil



ebm-papst Motores Ventiladores Ltda.
Av. José Giorgi, 301 Galpões B6+B7
Condominio Logical Center
BR-06707-100 Cotia - São Paulo
Phone +55 / 11 / 31 64 89 00
Fax +55 / 11 / 47 77 14 56
vendas@br.ebmpapst.com
www.ebmpapst.com.br



Canada



ebm-papst Canada Inc.
1800 Ironstone Manor, Unit 2
CDN-Pickering, Ontario, L1W3J9
Phone +1 / 905 / 420 / 35 33
Fax +1 / 905 / 420 / 37 72
sales@ca.ebmpapst.com
www.ebmpapst.ca



Mexico



ebm Industrial S.de R.L. de C.V.
Paseo de Tamarindos 400-A-5º Piso
Col. Bosques de las Lomas
MEX-Mexico 05120, D.F.
Phone +52 / 55 / 33 00 51 44
Fax +52 / 55 / 33 00 52 43
sales@mx.ebmpapst.com
www.ebmpapst.com.mx

USA



ebm-papst Inc.
P.O. Box 4009
100 Hyde Road
USA-Farmington, CT 06034
Phone +1 / 860 / 674 15 15
Fax +1 / 860 / 674 85 36
sales@us.ebmpapst.com
www.ebmpapst.us



ebm-papst Automotive & Drives, Inc.
3200 Greenfield, Suite 255
USA-Dearborn, MI 48120
Phone +1 / 313 / 406 80 80
Fax +1 / 313 / 406 80 81
automotive@us.ebmpapst.com
www.ebmpapst-automotive.us

Africa



South Africa



ebm-papst South Africa (Pty) Ltd.
P.O. Box 3124
1119 Yacht Avenue
ZA-2040 Honeydew
Phone +27 / 11 / 794 34 34
Fax +27 / 11 / 794 50 20
info@za.ebmpapst.com
www.ebmpapst.co.za

-  fan agent
-  compact fan agent
-  motor specialist
-  motor agent

ebm-papst representatives & subsidiaries

Asia

 **China**
 ebm-papst Ventilator (Shanghai) Co., Ltd.
 No. 418, Huajing Road
 WaiGaoQiao Free Trade Zone
 No. 2001, Yang Gao (N) Road
 VRC-200131 Shanghai, P.R. of China
 Phone +86 / 21 / 50 46 01 83
 Fax +86 / 21 / 50 46 11 19
 sales@cn.ebmpapst.com
 www.ebmpapst.com.cn

 **Hong Kong**
 ebm-papst Ventilator (Shanghai) Co., Ltd.
 Hong Kong Representative Office
 Unit Nos. 13-15, 9/F, Technology Park
 18 On Lai Street, Siu Lek Yuen, Shatin,
 N.T. Hong Kong P.R. of China
 Phone +852 / 21 45 / 86 78
 Fax +852 / 21 45 / 76 78
 info@hk.ebmpapst.com

 **India**
 ebm NADI International Pvt Ltd.
 26/3, G.N.T. Road, Erukkencherry
 IND-Chennai-600118
 Phone +91 / 44 / 25 37 25 56
 Fax +91 / 44 / 25 37 11 49
 ebmnadi@md2.vsnl.net.in
 www.ebmnadi.com

 **Indonesia**
 ebm-papst Indonesia
 Wisma Slipi, Jl. Letjend S. Parman Kav. 12
 14th Floor, No. 1410
 RI-11480 Jakarta Barat
 Phone +62 / 21 / 53 66 19 01
 Fax +62 / 21 / 53 66 19 05
 salesdept@id.ebmpapst.com

 **Israel**
 Polak Bros. Import Agencies Ltd.
 9 Hamefalsim Street
 IL-Kiryat Arie, Petach-Tikva 49514
 Phone +972 / 3 / 910 03 00
 Fax +972 / 3 / 579 66 79
 polak@polak.co.il
 www.polak.co.il

 **Japan**
 ebm-papst Industries Japan K.K.
 12 Floor, Benex S-3 Bldg.
 3-20-8 Shinyokohama, Kohoku-ku
 J-222-0033 Yokohama
 Phone +81 / 45 / 470 / 57 51
 Fax +81 / 45 / 470 / 57 52
 info@jp.ebmpapst.com
 www.ebmpapst.jp

 **Korea**
 ebm-papst Korea Co. Ltd.
 6F, Trutec Bldg.
 B 6-2, Digital Media City (DMC)
 Sangam-Dong, Mapo-Gu
 ROK-Seoul 121-270
 Phone +82 / 2 / 36 62 / 13 24
 Fax +82 / 2 / 36 62 / 13 26
 info@kr.ebmpapst.com
 www.ebmpapst.co.kr

 **Malaysia**
 ebm-papst Malaysia
 Representative Office
 Block F1, 9A-4, Jln PJU 1/42
 Dataran Prima
 MAL-47301 Petaling Jaya
 Phone +60 / 3 / 78 06 54 40
 Fax +60 / 3 / 78 06 54 41
 salesdept@my.ebmpapst.com

 **Singapore**
 ebm-papst SEA Pte. Ltd.
 No. 23 Ubi Road 4
 #06-00 Olympia Industrial Building
 SGP-Singapore 408620
 Phone +65 / 65 51 37 89
 Fax +65 / 68 42 84 39
 salesdept@sg.ebmpapst.com

 **Taiwan**
 ETECO Engineering & Trading Corp.
 10F-I, No. 92, Teh-Wei Str.
 RC-Tsow-Inn District, Kaohsiung
 Phone +886 / 7 / 557 42 68
 Fax +886 / 7 / 557 27 88
 eteco@ms22.hinet.net

 **Thailand**
 ebm-papst Thailand Co., Ltd.
 99/349 Na-Nakorn Bldg., 4th Floor
 Chaeng Wattana Road, Thungsonghong,
 THA-10210 Laksi, BKK
 Phone +66 / 2 / 5 76 15 24
 Fax +66 / 2 / 5 76 15 42
 salesdept@th.ebmpapst.com

 **United Arab Emirates**
 ebm-papst Middle East FZE
 PO Box 17755
 Jebel Ali Free Zone / FZS1 / AP05
 UAE-Dubai
 Phone +971 / 4 / 886 08 26
 Fax +971 / 4 / 886 08 27
 info@ae.ebmpapst.com
 www.ebmpapst.ae

Australia



Australia

ebm-papst A&NZ Pty Ltd.



10 Oxford Road



AUS-Laverton North, Victoria, 3026

Phone +61 / 3 / 83 25 64 00

Fax +61 / 3 / 83 25 64 64

sales@ebmpapst.com.au

www.ebmpapst.com.au



New Zealand

ebm-papst A&NZ Pty Ltd.



102 Henderson Valley Road



NZ-Henderson, Auckland 1230

Phone +64 / 9 / 837 18 84

Fax +64 / 9 / 837 18 99

sales@ebmpapst.com.au

www.ebmpapst.com.au

Printed in Germany

ebm-papst
Mulfingen GmbH & Co. KG

Bachmühle 2
D-74673 Mulfingen
Phone +49 (0) 79 38 / 81-0
Fax +49 (0) 79 38 / 81-110
info1@de.ebmpapst.com

www.ebmpapst.com

ebmpapst

Компания «Океан Электроники» предлагает заключение долгосрочных отношений при поставках импортных электронных компонентов на взаимовыгодных условиях!

Наши преимущества:

- Поставка оригинальных импортных электронных компонентов напрямую с производств Америки, Европы и Азии, а так же с крупнейших складов мира;
- Широкая линейка поставок активных и пассивных импортных электронных компонентов (более 30 млн. наименований);
- Поставка сложных, дефицитных, либо снятых с производства позиций;
- Оперативные сроки поставки под заказ (от 5 рабочих дней);
- Экспресс доставка в любую точку России;
- Помощь Конструкторского Отдела и консультации квалифицированных инженеров;
- Техническая поддержка проекта, помощь в подборе аналогов, поставка прототипов;
- Поставка электронных компонентов под контролем ВП;
- Система менеджмента качества сертифицирована по Международному стандарту ISO 9001;
- При необходимости вся продукция военного и аэрокосмического назначения проходит испытания и сертификацию в лаборатории (по согласованию с заказчиком);
- Поставка специализированных компонентов военного и аэрокосмического уровня качества (Xilinx, Altera, Analog Devices, Intersil, Interpoint, Microsemi, Actel, Aeroflex, Peregrine, VPT, Syfer, Eurofarad, Texas Instruments, MS Kennedy, Miteq, Cobham, E2V, MA-COM, Hittite, Mini-Circuits, General Dynamics и др.);

Компания «Океан Электроники» является официальным дистрибьютором и эксклюзивным представителем в России одного из крупнейших производителей разъемов военного и аэрокосмического назначения «JONHON», а так же официальным дистрибьютором и эксклюзивным представителем в России производителя высокотехнологичных и надежных решений для передачи СВЧ сигналов «FORSTAR».



JONHON

«JONHON» (основан в 1970 г.)

Разъемы специального, военного и аэрокосмического назначения:

(Применяются в военной, авиационной, аэрокосмической, морской, железнодорожной, горно- и нефтедобывающей отраслях промышленности)

«FORSTAR» (основан в 1998 г.)

ВЧ соединители, коаксиальные кабели, кабельные сборки и микроволновые компоненты:

(Применяются в телекоммуникациях гражданского и специального назначения, в средствах связи, РЛС, а так же военной, авиационной и аэрокосмической отраслях промышленности).



Телефон: 8 (812) 309-75-97 (многоканальный)

Факс: 8 (812) 320-03-32

Электронная почта: ocean@oceanchips.ru

Web: <http://oceanchips.ru/>

Адрес: 198099, г. Санкт-Петербург, ул. Калинина, д. 2, корп. 4, лит. А