

TELEDYNE RELAYS

A Unit of Teledyne Electronics and Communications

SURFACE MOUNT, MAGNETIC-LATCHING BROADBAND RF RELAYS DPDT

SERIES GRF180

DESCRIPTION

The Series GRF180 relay is the first hermetically sealed, ultraminiature RF relay designed from inception for surface mount applications. This magnetic-latching relay features extremely low internal circuit losses for exceptional time and frequency domain response characteristics through and beyond the UHF spectrum and into the S band. The GRF180 features a unique ground shield that isolates and shields each lead to ensure excellent contact-to-contact and pole-to-pole isolation. This ground shield provides a ground interface that results in improved high-frequency performance as well as parametric repeatability. The GRF180 extends performance advantages over similar RF devices that simply offer formed leads for surface mounting.

The GRF180 is robust to shock, vibration and temperature extremes for use in space applications and other demanding environments. It is engineered for use in RF attenuators, RF

switch matrices, automated test equipment, spacecraft and other applications that require dependable high-frequency signal fidelity and performance. Its low profile and .100" grid spaced terminals make the GRF180 ideal for applications where extreme packaging density and/or close PC board spacing are required.

Unique features and manufacturing techniques include:

- Positive mounting means to RF ground plane.
- Unique uniframe design provides high magnetic efficiency and mechanical rigidity.
- High force/mass ratios for resistance to shock and vibration.
- Advanced cleaning techniques provide maximum assurance of internal cleanliness.
- Gold-plated precious metal alloy contacts ensure reliable dc and RF signal switching, as well as low and stable insertion loss.
- Robust to high temperature solder reflow environments.

PRINCIPLE OF OPERATION

Energizing Coil A produces a magnetic field opposing the magnetic field of the permanent magnet in Circuit A. As the net holding force decreases, the attractive force in the air gap of Circuit B, which also results from the magnetic field of the permanent magnet, becomes great enough to break the armature free of Core A, and snap it into a closed position against Core B. The armature remains in this position upon removal of power from Coil A, but will snap back into position A upon energizing Coil B. Since operation depends upon cancellation of a magnetic field, it is necessary to apply the correct polarity to the relay coils as indicated on the relay schematic.

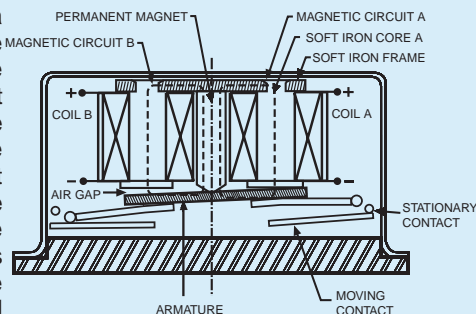

When latching relays are installed in equipment, the latch and reset coils should not be pulsed simultaneously. Coils should not be pulsed with less than rated coil voltage and the pulse width should be a minimum of three times the specified operate time of the relay. If these conditions are not followed, it is possible for the relay to be in the magnetic neutral position.

ENVIRONMENTAL AND PHYSICAL SPECIFICATIONS

Temperature (Ambient)	Storage	-65°C to +125°C
	Operating	-55°C to +85°C
Vibration (General Note 1)		30 g's to 500 Hz
Shock (General Note 1)		100 g's, 6 msec, half-sine
Enclosure		Hermetically sealed
Weight		0.10 oz. (2.9g) max.

SERIES GRF180

TYPICAL RF CHARACTERISTICS (See RF Notes)

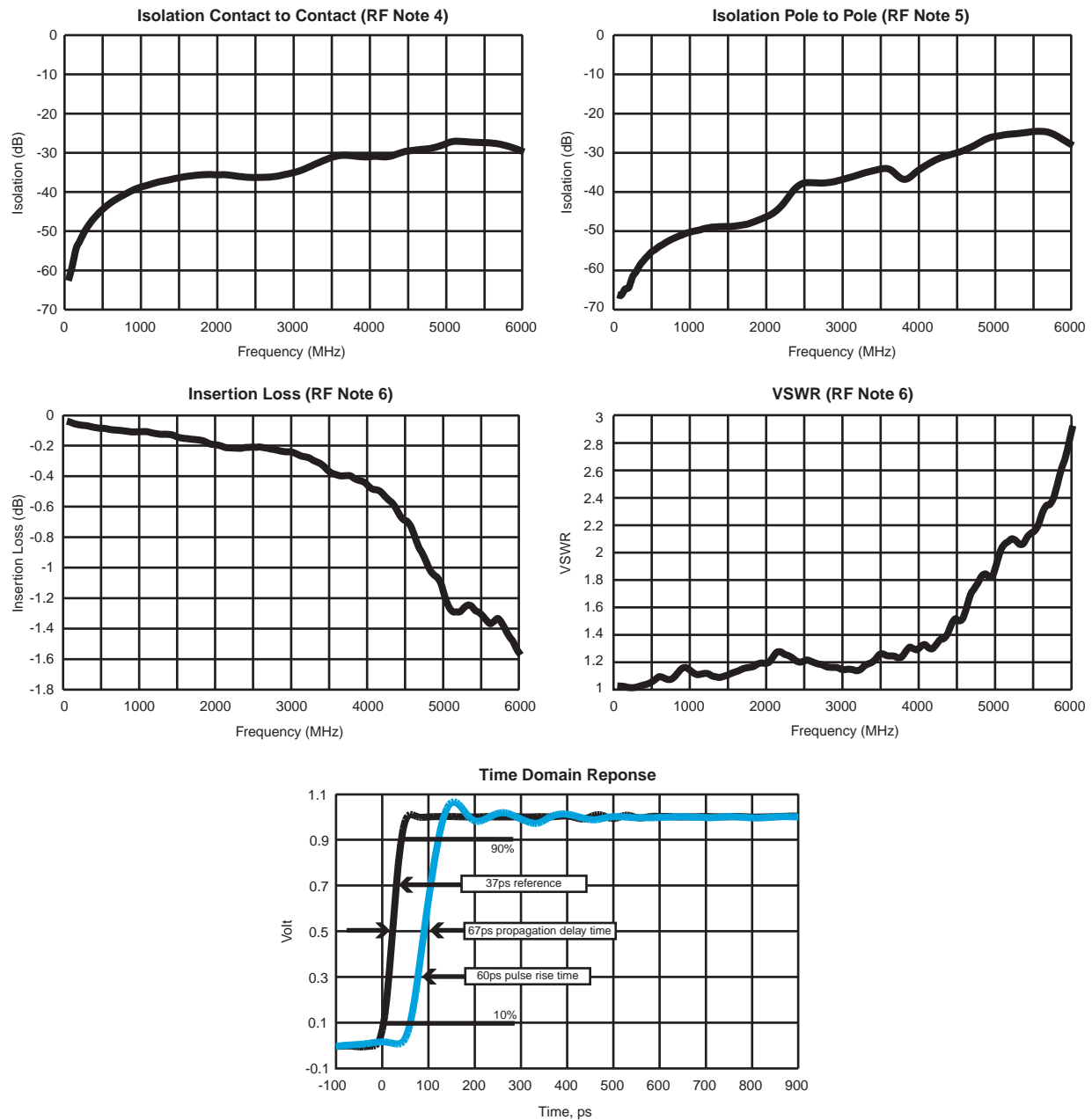

RF NOTES

- Test conditions:
 - Fixture: .031" copper clad, reinforced PTFE, RT/duroid® 6002 with SMA connectors. (RT/duroid® is a registered trademark of Rogers Corporation.)
 - RF ground shield is soldered to PCB RF ground plane.
 - Room ambient temperature.
 - Terminals not tested were terminated with 50-ohm load.
 - Contact signal level: -10 dBm.
 - No. of test samples: 3.
- Data presented herein represents typical characteristics and is not intended for use as specification limits.
- Data is per pole, except for pole-to-pole data.
- Data is the average from readings taken on all open contacts.
- Data is the average from readings taken on poles after Coil A is energized then Coil B is energized.
- Data is the average from readings taken on all closed contacts.
- Test fixture effect de-embedded from frequency and time response data.

SERIES GRF180

GENERAL ELECTRICAL SPECIFICATIONS (@ 25°C) (General Note 2)

Contact Arrangement	2 Form C (DPDT)
Rated Duty	Continuous
Contact Resistance	.15Ω maximum before life; 0.25Ω maximum after life at 0.25A/28Vdc
Contact Load Rating (DC)	Resistive: 0.25A/28Vdc Low Level: 10 to 50 μA/10 to 50 mV
Characteristic Contact Life Ratings (General Note 3)	10,000,000 cycles (typical) at low level (General Note 3) 100,000 cycles minimum at all other loads specified above
Contact Overload Rating	0.5A/28Vdc Resistive (100 cycles minimum)
Contact Carry Rating	Contact factory
Coil Operating Power	GRF180-5: 410 mW typical @ nominal rated voltage
	GRF180-12: 288 mW typical @ nominal rated voltage
	GRF180-26: 351 mW typical @ nominal rated voltage
Operate Time	2.0 msec. maximum at nominal rated coil voltage
Minimum Operate Pulse	6.0 msec. width at rated voltage
Interconnect Capacitance	0.02 pf typical
Insulation Resistance	1,000 MΩ minimum between mutually isolated terminals
Dielectric Strength	Atmospheric pressure: 350 Vrms (60 Hz)

DETAILED ELECTRICAL SPECIFICATIONS (@ 25°C) (General Note 2)

BASE PART NUMBERS		GRF180-5	GRF180-12	GRF180-26
Coil Voltage (Vdc)	Nom.	5.0	12.0	26.5
	Max.	6.0	16.0	32.0
Coil Resistance (Ohms ±20%)		61	500	2000
Set & Reset Voltage (Vdc max.)		3.5	9.0	18.0

GENERAL NOTES

- Relays will exhibit no contact chatter in excess of 10 μsec or transfer in excess of 1 μsec.
- Unless otherwise specified, parameters are initial values.
- For extended contact life ratings, contact factory.
- Contacts shown in position resulting when Coil B last energized.
- For hi-rel applications, contact factory at (800) 284-7007.
- Relays may be subjected to 260°C, peak solder reflow temperature, 1 minute, 3 passes.
- Butt-lead ends are coplanar within .003" (0.08).
- Application notes available for PCB layout and mounting information.

OUTLINE DIMENSIONS

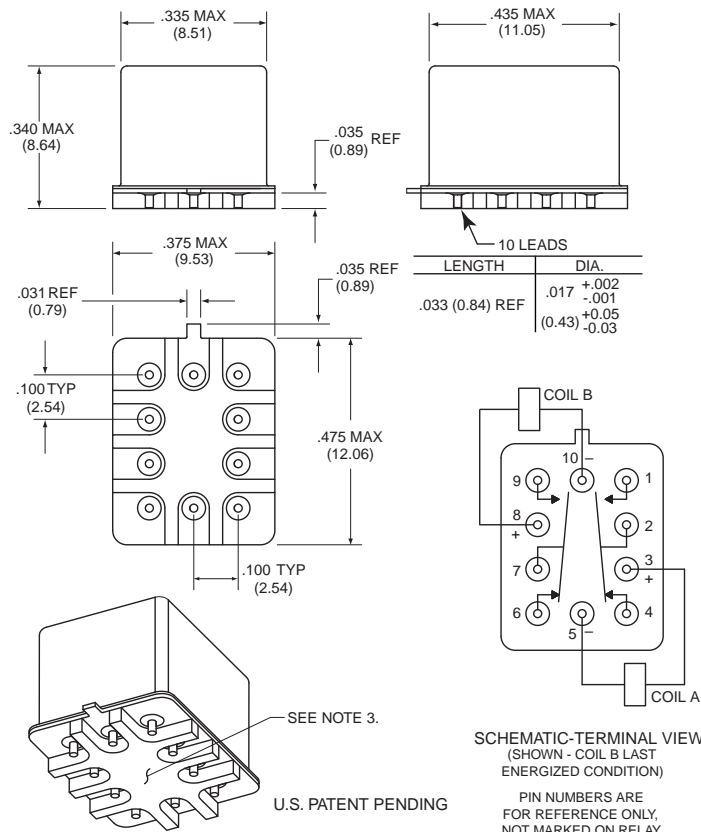

NOTES:

- DIMENSIONS ARE IN INCHES. METRIC EQUIVALENTS IN MILLIMETERS ARE SHOWN IN ().
- UNLESS OTHERWISE SPECIFIED, TOLERANCES ON DIMENSIONS ARE .010 INCH (0.025 mm).
- FOR OPTIMAL RF PERFORMANCE, SOLDER BOTTOM OF GROUND SHIELD TO PCB RF GROUND PLANE.

Appendix A: Spacer Pads

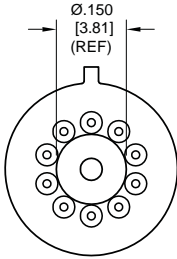
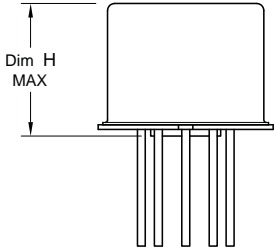
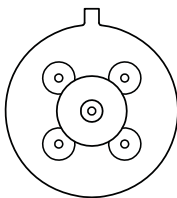
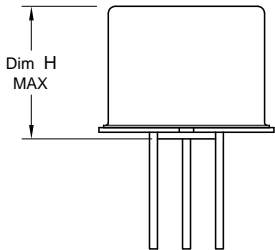
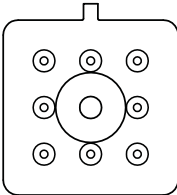
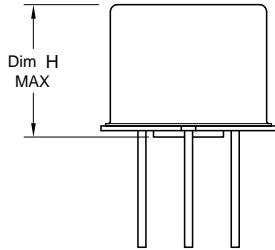
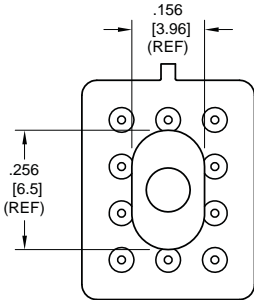
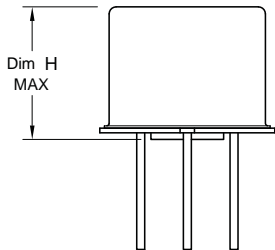
Pad designation and bottom view dimensions	Height	For use with the following:	Dim. H Max.
 <p style="text-align: center;">“M4” Pad for TO-5</p>		ER411T ER412, ER412D, ER412DD	.295 (7.49)
		712, 712D, 712TN, RF300, RF310, RF320	.300 (7.62)
		ER420, ER422D, ER420DD, 421, ER421D, ER421DD, ER422, ER422D, ER422DD, 722, 722D, RF341	.305 (7.75)
		ER431T, ER432T, ER432, ER432D, ER432DD	.400 (10.16)
		732, 732D, 732TN, RF303, RF313, RF323	.410 (10.41)
		RF312	.350 (8.89)
 <p style="text-align: center;">“M4” Pad for TO-5</p>		ER411, ER411D, ER411DD	.295 (7.49)
		ER431, ER431D, ER431DD	.400 (10.16)
		RF311	.300 (7.62)
		RF331	.410 (10.41)
 <p style="text-align: center;">“M4” Pad for Centigrid®</p>		172, 172D	.305 (7.75)
		ER114, ER114D, ER114DD, J114, J114D, J114DD	.300 (7.62)
		ER134, ER134D, ER134DD, J134, J134D, J134DD	.400 (10.16)
		RF100	.315 (8.00)
		RF103	.420 (10.67)
 <p style="text-align: center;">“M9” Pad for Centigrid®</p>		122C, A152	.320 (8.13)
		ER116C, J116C	.300 (7.62)
		ER136C, J136C	.400 (10.16)
		RF180	.325 (8.25)
		A150	.305 (7.75)

Notes:

1. Spacer pad material: Polyester film.
2. To specify an “M4” or “M9” spacer pad, refer to the mounting variants portion of the part numbering example in the applicable datasheet.
3. Dimensions are in inches (mm).
4. Unless otherwise specified, tolerance is $\pm .010$ (.25).
5. Add 10 m Ω to the contact resistance show in the datasheet.
6. Add 0.01 oz. (0.25 g) to the weight of the relay assembly shown in the datasheet.

Appendix A: Spreader Pads

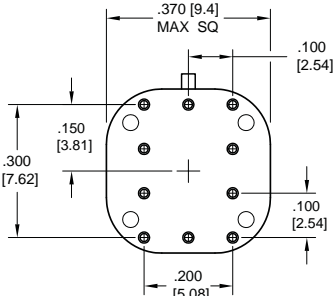
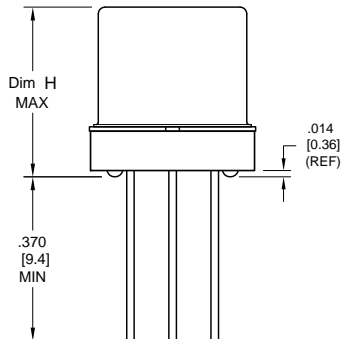
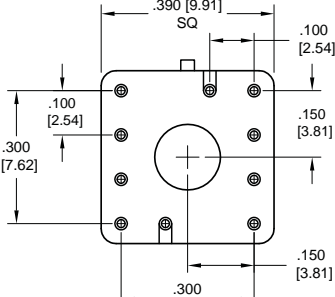
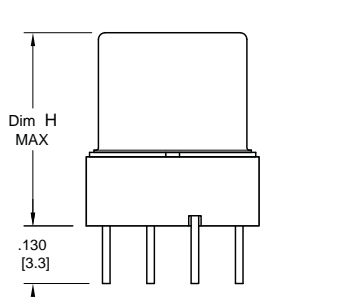
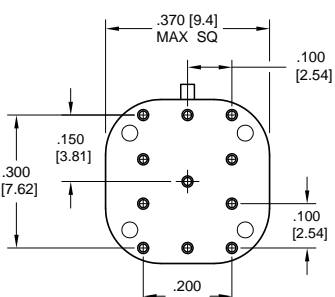
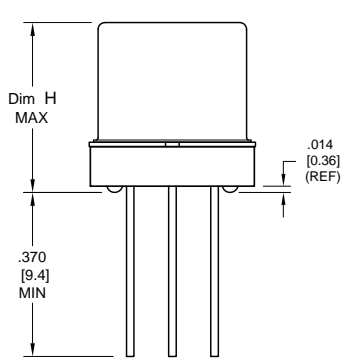
Pad designation and bottom view dimensions	Height	For use with the following:	Dim. H Max.
 <p>"M" Pad <u>5/</u> <u>6/</u> <u>9/</u></p>		ER411T, J411T, ER412, ER412D ER412DD, J412, J412D, J412DD ER412T, J412T	.388 (9.86)
		712, 712D, 712TN	.393 (9.99)
		ER431T, J431T, ER432, ER432D ER432DD, J432, J432D, J432DD ER432T, J432T	.493 (12.52)
		732, 732D, 732TN	.503 (12.78)
		ER420, J420, ER420D, J420D ER420DD, J420DD, ER421, J421 ER421D, J421D, ER421DD J422D, ER422DD, J422DD, 722	.398 (10.11)
 <p>"M4" Pad <u>7/</u> <u>8/</u></p>		ER411T ER412, ER412D, ER412DD J412, J412D, J412DD	.441 (11.20)
		712, 712D	.451 (11.46)
		ER421, ER421D, ER421DD 722, 732D	.451 (11.46)
		ER431T ER432, ER432D, ER432DD	.546 (13.87)
		732, 732D	.556 (14.12)
 <p>"M5" Pad <u>5/</u> <u>6/</u> <u>9/</u></p>		ER411, ER411D, ER411DD ER411TX ER412X, ER412DX, ER412DDX ER412TX	.388 (9.86)
		712X, 712DX, 712TNX	.393 (9.99)
		ER420X, ER420DX, ER420DDX ER421X, ER421DX, ER421DDX ER422X, ER422DX ER422DDX, 722X, 722DDX	.398 (10.11)
		ER431, ER431D, ER431DD ER431TX ER432X, ER432DX, ER432DDX ER432TX	.493 (12.52)
		732X, 732DX, 732TNX	.503 (12.78)

Notes:

1. Spreader pad material: Diallyl Phthalate.
2. To specify an "M", "M2" or "M3" spreader pad, refer to the mounting variants portion of the part number example in the applicable datasheet.
3. Dimensions are in inches (mm).
4. Unless otherwise specified, tolerance is $\pm .010$ " (0.25).
- 5/. Add 25 m Ω to the contact resistance shown in the datasheet.
- 6/. Add .01 oz. (0.25 g) to the weight of the relay assembly shown in the datasheet.
- 7/. Add 50 m Ω to the contact resistance shown in the datasheet.
- 8/. Add 0.025 oz (0.71 g) to the weight of the relay assembly shown in the datasheet.
- 9/. M3 pad to be used only when the relay has a center pin (e.g. ER411M3-12A, 722XM3-26.)

Appendix A: Ground Pin Positions

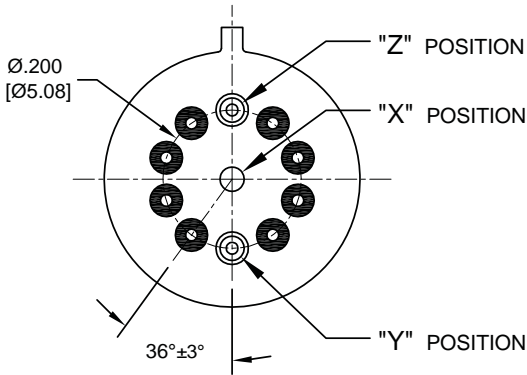

TO-5 Relays:

ER411T, ER412, ER412T, ER420, ER421, ER422,
ER431T, ER432, ER432T, 712, 712TN, 400H, 400K,
400V, RF300, RF303, RF341, RF312, RF310, RF313,
RF320, RF323

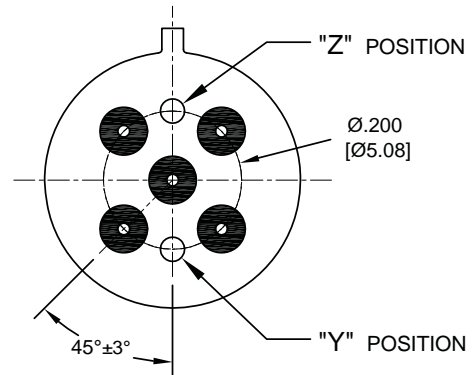

TO-5 Relays:

ER411, ER431, RF311, RF331

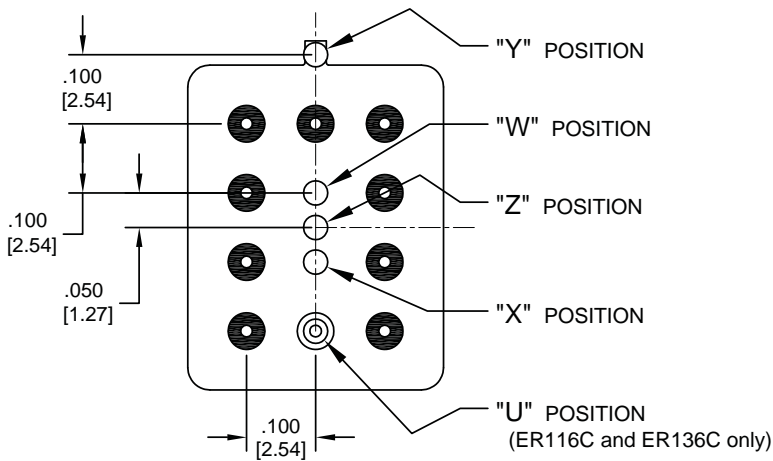

Centigrid® Relays:

RF180, ER116C, 122C, ER136C

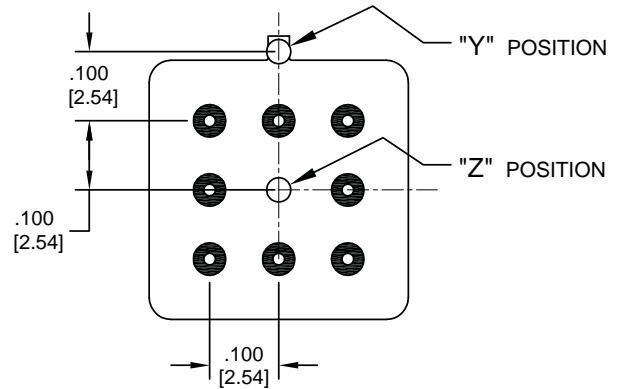

Centigrid® Relays:

RF100, RF103, ER114, ER134, 172

- Indicates ground pin position
- Indicates glass insulated lead position
- ⊙ Indicates ground pin or lead position depending on relay type

NOTES

1. Terminal views shown
2. Dimensions are in inches (mm)
3. Tolerances: ± .010 (±.25) unless otherwise specified
4. Ground pin positions are within .015 (0.38) dia. of true position
5. Ground pin head dia., 0.035 (0.89) ref: height 0.010 (0.25) ref.
6. Lead dia. 0.017 (0.43) nom.

Компания «Океан Электроники» предлагает заключение долгосрочных отношений при поставках импортных электронных компонентов на взаимовыгодных условиях!

Наши преимущества:

- Поставка оригинальных импортных электронных компонентов напрямую с производств Америки, Европы и Азии, а так же с крупнейших складов мира;
- Широкая линейка поставок активных и пассивных импортных электронных компонентов (более 30 млн. наименований);
- Поставка сложных, дефицитных, либо снятых с производства позиций;
- Оперативные сроки поставки под заказ (от 5 рабочих дней);
- Экспресс доставка в любую точку России;
- Помощь Конструкторского Отдела и консультации квалифицированных инженеров;
- Техническая поддержка проекта, помощь в подборе аналогов, поставка прототипов;
- Поставка электронных компонентов под контролем ВП;
- Система менеджмента качества сертифицирована по Международному стандарту ISO 9001;
- При необходимости вся продукция военного и аэрокосмического назначения проходит испытания и сертификацию в лаборатории (по согласованию с заказчиком);
- Поставка специализированных компонентов военного и аэрокосмического уровня качества (Xilinx, Altera, Analog Devices, Intersil, Interpoint, Microsemi, Actel, Aeroflex, Peregrine, VPT, Syfer, Eurofarad, Texas Instruments, MS Kennedy, Miteq, Cobham, E2V, MA-COM, Hittite, Mini-Circuits, General Dynamics и др.);

Компания «Океан Электроники» является официальным дистрибьютором и эксклюзивным представителем в России одного из крупнейших производителей разъемов военного и аэрокосмического назначения «JONHON», а так же официальным дистрибьютором и эксклюзивным представителем в России производителя высокотехнологичных и надежных решений для передачи СВЧ сигналов «FORSTAR».



JONHON

«JONHON» (основан в 1970 г.)

Разъемы специального, военного и аэрокосмического назначения:

(Применяются в военной, авиационной, аэрокосмической, морской, железнодорожной, горно- и нефтедобывающей отраслях промышленности)

«FORSTAR» (основан в 1998 г.)

ВЧ соединители, коаксиальные кабели,
кабельные сборки и микроволновые компоненты:

(Применяются в телекоммуникациях гражданского и специального назначения, в средствах связи, РЛС, а так же военной, авиационной и аэрокосмической отраслях промышленности).



Телефон: 8 (812) 309-75-97 (многоканальный)

Факс: 8 (812) 320-03-32

Электронная почта: ocean@oceanchips.ru

Web: <http://oceanchips.ru/>

Адрес: 198099, г. Санкт-Петербург, ул. Калинина, д. 2, корп. 4, лит. А