

DATA SHEET

SKY12208-478LF: 0.02 to 2.7 GHz 50 W High Power Silicon PIN Diode SPDT Switch

Applications

- Transmit/receive and fail-safe switching in land mobile radios, public safety radios, and military communication systems

Features

- High power handling: 50 W CW, 300 W peak
- Low insertion loss: 0.3 dB typical
- Controlled with positive power supply
- High antenna to receive isolation: 45 dB typical
- Bias driver circuit available on request
- Small, QFN (16-pin, 4 x 4 mm) Pb-free package (MSL1, 260 °C per JEDEC J-STD-020)



Skyworks Green™ products are compliant with all applicable legislation and are halogen-free. For additional information, refer to *Skyworks Definition of Green™*, document number SQ04-0074.

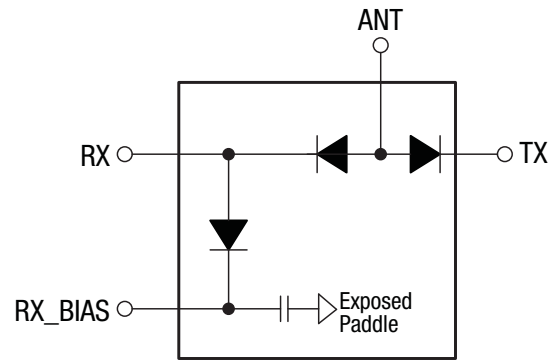

S2403

Figure 1. SKY12208-478LF Block Diagram

Description

The SKY12208-478LF is a high power handling, Single-Pole, Double-Throw (SPDT) silicon PIN diode switch. The device can cover two frequency bands, 0.02 to 0.70 GHz or 0.05 to 2.7 GHz, by changing the value of an RF choke in the SMT bias network. The different Evaluation Board components for each band are noted in Table 10.

The SKY12208-478LF features low insertion loss, excellent power handling, and superb linearity with low DC power consumption. The device is well-suited for use as a high power transmit/receive switch in a variety of telecommunication systems.

The device is provided in a 4 x 4 mm, 16-pin Quad Flat No-Lead (QFN) package. A functional block diagram is shown in Figure 1. The pin configuration and package are shown in Figure 2. Signal pin assignments and functional pin descriptions are provided in Table 1.



Figure 2. SKY12208-478LF Pinout – 16-Pin QFN (Top View)

Table 1. SKY12208-478LF Signal Descriptions

Pin	Name	Description	Pin	Name	Description
1	GND	Ground. Must be connected to ground using lowest possible impedance.	9	RX_BIAS	RF ground port and DC bias input port
2	ANT	Antenna RF port and DC bias input port	10	N/C	No connection
3	GND	Ground. Must be connected to ground using lowest possible impedance.	11	N/C	No connection
4	N/C	No connection	12	N/C	No connection
5	N/C	No connection	13	GND	Ground. Must be connected to ground using lowest possible impedance.
6	GND	Ground. Must be connected to ground using lowest possible impedance.	14	TX	Transmit RF input port and DC bias input port
7	RX	Receive output port and DC bias input port	15	GND	Ground. Must be connected to ground using lowest possible impedance.
8	GND	Ground. Must be connected to ground using lowest possible impedance.	16	N/C	No connection

Electrical and Mechanical Specifications

The absolute maximum ratings of the SKY12208-478LF are provided in Table 2. Recommended operating conditions are specified in Table 3 and electrical specifications are provided in Table 4 (28 V bias @ 0.25 GHz), Table 5 (5 V bias @ 0.25 GHz), Table 6 (5 V bias @ 2.0 GHz), and Table 7 (28 V bias @ 2.0 GHz).

Typical performance characteristics of the SKY12208-478LF are illustrated in Figures 3 through 8 (0.25 GHz) and Figures 9 through 18 (2.0 GHz).

The state of the SKY12208-478LF is determined by the logic provided in Table 8. Table 9 provides the logic for use with the SKY12208-478LF Evaluation Board.

Power derating data is plotted against temperature in Figures 19 and 20. Equivalent circuit diagrams for transmit and receive are shown in Figure 21.

Table 2. SKY12208-478LF Absolute Maximum Ratings

Parameter	Symbol	Minimum	Maximum	Units
RF CW input power, TX and ANT ports ($T_{\text{SUBSTRATE}} = 25\text{ }^{\circ}\text{C}$)	P_{IN}		75	W
RF peak input power, TX and ANT ports ($T_{\text{SUBSTRATE}} = 25\text{ }^{\circ}\text{C}$, RF burst width = 10 μs , RF burst repetition rate = 25 kHz)	P_{IN}		300	W
RF CW input power, RX port ($T_{\text{SUBSTRATE}} = 25\text{ }^{\circ}\text{C}$)	P_{IN}		60	W
RF peak input power, RX port ($T_{\text{SUBSTRATE}} = 25\text{ }^{\circ}\text{C}$, RF burst width = 10 μs , RF burst repetition rate = 25 kHz)	P_{IN}		240	W
Control port reverse voltage	V_{CTL}		200	V
Control port forward current	I_{CTL}		200	mA
Operating temperature	T_{OP}	-55	+175	$^{\circ}\text{C}$
Storage temperature	T_{STG}	-55	+200	$^{\circ}\text{C}$
Electrostatic discharge:	ESD			
Charged Device Model (CDM), Class 4			1000	V
Human Body Model (HBM), Class 1A			250	V
Machine Model (MM), Class A			100	V

Note: Exposure to maximum rating conditions for extended periods may reduce device reliability. There is no damage to device with only one parameter set at the limit and all other parameters set at or below their nominal value. Exceeding any of the limits listed here may result in permanent damage to the device.

CAUTION: Although this device is designed to be as robust as possible, Electrostatic Discharge (ESD) can damage this device. This device must be protected at all times from ESD. Static charges may easily produce potentials of several kilovolts on the human body or equipment, which can discharge without detection. Industry-standard ESD precautions should be used at all times.

Table 3. Recommended Operating Conditions (Per ANT, TX, RX, and RX_BIAS Inputs)

Parameter	Symbol	Min	Typical	Max	Units
Control port reverse voltage	V_{CTL}	5	28	100	V
Control port forward current	I_{CTL}	20	50	100	mA

Table 4. SKY12208-478LF Electrical Specifications, Bias Voltage = 28 V (1 of 2) (Note 1)
(T_{OP} = +25 °C, Characteristic Impedance [Z₀] = 50 Ω, EVB Optimized for 0.02 to 0.70 GHz Operation, Unless Otherwise Noted)

Parameter	Symbol	Test Condition	Min	Typical	Max	Units	
Insertion loss, TX to ANT ports	IL _{TX-ANT}	V _{PIN_2} = 1 V, I _{PIN_14} = -50 mA, I _{PIN_9} = -50 mA, V _{PIN_7} = 28 V, TX port P _{IN} @ pin 14 = 0 dBm:		0.39		dB	
							0.02 GHz
							0.05 GHz
							0.25 GHz
							0.50 GHz
0.70 GHz							
Insertion loss, ANT to RX ports	IL _{ANT-RX}	V _{PIN_2} = 1 V, V _{PIN_14} = 28 V, I _{PIN_7} = -50 mA, V _{PIN_9} = 28 V, ANT port P _{IN} @ pin 2 = 0 dBm:		0.40		dB	
							0.02 GHz
							0.05 GHz
							0.25 GHz
							0.50 GHz
0.70 GHz							
Isolation, TX to RX ports	ISO _{TX-RX}	V _{PIN_2} = 1 V, I _{PIN_14} = -50 mA, I _{PIN_9} = -50 mA, V _{PIN_7} = 28 V, TX port P _{IN} @ pin 14 = 0 dBm:		49		dB	
							0.02 GHz
							0.05 GHz
							0.25 GHz
							0.50 GHz
0.70 GHz							
Isolation, ANT to TX ports	ISO _{ANT-TX}	V _{PIN_2} = 1 V, V _{PIN_14} = 28 V, I _{PIN_7} = -50 mA, V _{PIN_9} = 28 V, ANT port P _{IN} @ pin 2 = 0 dBm:		58		dB	
							0.02 GHz
							0.05 GHz
							0.25 GHz
							0.50 GHz
0.70 GHz							
Isolation, ANT to RX ports	ISO _{ANT-RX}	V _{PIN_2} = 1 V, I _{PIN_14} = -50 mA, I _{PIN_9} = -50 mA, V _{PIN_7} = 28 V, ANT port P _{IN} @ pin 2 = 0 dBm:		49		dB	
							0.02 GHz
							0.05 GHz
							0.25 GHz
							0.50 GHz
0.70 GHz							

Table 4. SKY12208-478LF Electrical Specifications, Bias Voltage = 28 V (2 of 2) (Note 1)
(T_{OP} = +25 °C, Characteristic Impedance [Z₀] = 50 Ω, EVB Optimized for 0.02 to 0.70 GHz Operation, Unless Otherwise Noted)

Parameter	Symbol	Test Condition	Min	Typical	Max	Units		
Input return loss		0.02 to 0.70 GHz: RX insertion loss state, ANT port (@ pin 2)		22		dB		
		TX insertion loss state, TX port (@ pin 14)		23		dB		
Transmit 2 nd harmonic	2fo	TX insertion loss state, TX port P _{IN} @ pin 14 = +30 dBm:						
		0.05 GHz		-78		dBc		
		0.25 GHz		-82		dBc		
		0.50 GHz		-95		dBc		
Transmit 3 rd harmonic	3fo	TX insertion loss state, TX port P _{IN} @ pin 14 = +30 dBm:						
		0.05 GHz		-92		dBc		
		0.25 GHz		-85		dBc		
		0.50 GHz		-81		dBc		
Transmit 3 rd Order Input Intercept Point	IIP3	0.70 GHz		-78		dBc		
		V _{PIN_2} = 1 V, I _{PIN_14} = -50 mA, I _{PIN_9} = -50 mA, V _{PIN_7} = 28 V, TX port P _{IN} @ pin 14 = +30 dBm/tone, tone spacing = 1 MHz, @ 0.25 GHz		+70		dBm		
		Maximum transmit CW input power	P _{IN_CW}	V _{PIN_2} = 1 V, I _{PIN_14} = -50 mA, I _{PIN_9} = -50 mA, V _{PIN_7} = 28 V, 0.25 GHz		50		W
		Maximum receive CW input power	P _{IN_CW}	V _{PIN_2} = 1 V, V _{PIN_14} = 28 V, I _{PIN_7} = -50 mA, V _{PIN_9} = 28 V, 0.25 GHz		40		W
Transmit RF switching time	tsw	10% to 90% RF on, repetition rate = 0.1 MHz, @ 0.25 GHz		85		ns		

Note 1: Performance is guaranteed only under the conditions listed in this Table.

Table 5. SKY12208-478LF Electrical Specifications, Bias Voltage = 5 V (1 of 2) (Note 1)
(T_{OP} = +25 °C, Characteristic Impedance [Z₀] = 50 Ω, EVB Optimized for 0.02 to 0.70 GHz Operation, Unless Otherwise Noted)

Parameter	Symbol	Test Condition	Min	Typical	Max	Units
Insertion loss, TX to ANT ports	IL _{TX-ANT}	V _{PIN_2} = 1 V, I _{PIN_14} = -50 mA, I _{PIN_9} = -50 mA, V _{PIN_7} = 5 V, TX port P _{IN} @ pin 14 = 0 dBm: 0.02 GHz 0.05 GHz 0.25 GHz 0.50 GHz 0.70 GHz				
				0.37		dB
				0.21		dB
				0.19		dB
				0.30		dB
0.50		dB				
Insertion loss, ANT to RX ports	IL _{ANT-RX}	V _{PIN_2} = 1 V, V _{PIN_14} = 5 V, I _{PIN_7} = -50 mA, V _{PIN_9} = 5 V, ANT port P _{IN} @ pin 2 = 0 dBm: 0.02 GHz 0.05 GHz 0.25 GHz 0.50 GHz 0.70 GHz				
				0.40		dB
				0.23		dB
				0.20		dB
				0.32		dB
0.50		dB				
Isolation, TX to RX ports	ISO _{TX-RX}	V _{PIN_2} = 1 V, I _{PIN_14} = -50 mA, I _{PIN_9} = -50 mA, V _{PIN_7} = 5 V, TX port P _{IN} @ pin 14 = 0 dBm: 0.02 GHz 0.05 GHz 0.25 GHz 0.50 GHz 0.70 GHz				
				49		dB
				49		dB
				43		dB
				43		dB
45		dB				
Isolation, ANT to TX ports	ISO _{ANT-TX}	V _{PIN_2} = 1 V, V _{PIN_14} = 5 V, I _{PIN_7} = -50 mA, V _{PIN_9} = 5 V, ANT port P _{IN} @ pin 2 = 0 dBm: 0.02 GHz 0.05 GHz 0.25 GHz 0.50 GHz 0.70 GHz				
				61		dB
				48		dB
				37		dB
				31		dB
29		dB				
Isolation, ANT to RX ports	ISO _{ANT-RX}	V _{PIN_2} = 1 V, I _{PIN_14} = -50 mA, I _{PIN_9} = -50 mA, V _{PIN_7} = 5 V, ANT port P _{IN} @ pin 2 = 0 dBm: 0.02 GHz 0.05 GHz 0.25 GHz 0.50 GHz 0.70 GHz				
				49		dB
				49		dB
				43		dB
				43		dB
45		dB				

Table 5. SKY12208-478LF Electrical Specifications, Bias Voltage = 5 V (2 of 2) (Note 1)
(T_{OP} = +25 °C, Characteristic Impedance [Z₀] = 50 Ω, EVB Optimized for 0.02 to 0.70 GHz Operation, Unless Otherwise Noted)

Parameter	Symbol	Test Condition	Min	Typical	Max	Units		
Input return loss		0.02 to 0.70 GHz: RX insertion loss state, ANT port (@ pin 2)		22		dB		
		TX insertion loss state, TX port (@ pin 14)		24		dB		
Transmit 2 nd harmonic	2fo	TX insertion loss state, TX port P _{IN} @ pin 14 = +30 dBm:						
		0.05 GHz		-31		dBc		
		0.25 GHz		-40		dBc		
		0.50 GHz		-50		dBc		
Transmit 3 rd harmonic	3fo	TX insertion loss state, TX port P _{IN} @ pin 14 = +30 dBm:						
		0.05 GHz		-36		dBc		
		0.25 GHz		-43		dBc		
		0.50 GHz		-52		dBc		
Transmit 3 rd Order Input Intercept Point	IIP3	0.70 GHz		-67		dBc		
		V _{PIN_2} = 1 V, I _{PIN_14} = -50 mA, I _{PIN_9} = -50 mA, V _{PIN_7} = 5 V, TX port P _{IN} @ pin 14 = +30 dBm/tone, tone spacing = 1 MHz, @ 0.25 GHz		+70		dBm		
		Maximum transmit CW input power	P _{IN_CW}	V _{PIN_2} = 1 V, I _{PIN_14} = -50 mA, I _{PIN_9} = -50 mA, V _{PIN_7} = 5 V, 0.25 GHz		15		W
		Maximum receive CW input power	P _{IN_CW}	V _{PIN_2} = 1 V, V _{PIN_14} = 5 V, I _{PIN_7} = 50 mA, V _{PIN_9} = 5 V, 0.25 GHz		10		W
Transmit RF switching time	tsw	10% to 90% RF on, repetition rate = 0.1 MHz, @ 0.25 GHz		85		ns		

Note 1: Performance is guaranteed only under the conditions listed in this Table.

Table 6. SKY12208-478LF Electrical Specifications, Bias Voltage = 28 V (1 of 2) (Note 1)
(T_{OP} = +25 °C, Characteristic Impedance [Z₀] = 50 Ω, EVB Optimized for 0.05 to 2.70 GHz Operation, Unless Otherwise Noted)

Parameter	Symbol	Test Condition	Min	Typical	Max	Units	
Insertion loss, TX to ANT ports	IL _{TX-ANT}	V _{PIN_2} = 1 V, I _{PIN_14} = -50 mA, I _{PIN_9} = -50 mA, V _{PIN_7} = 28 V, TX port P _{IN} @ pin 14 = 0 dBm:					
			0.05 GHz		0.48	0.50	dB
			0.50 GHz		0.25		dB
			1.00 GHz		0.23		dB
			1.50 GHz		0.27		dB
			2.00 GHz		0.33		dB
			2.50 GHz		0.39		dB
Insertion loss, ANT to RX ports	IL _{ANT-RX}	V _{PIN_2} = 1 V, V _{PIN_14} = 28 V, I _{PIN_7} = -50 mA, V _{PIN_9} = 28 V, ANT port P _{IN} @ pin 2 = 0 dBm:					
			0.05 GHz		0.45	0.50	dB
			0.50 GHz		0.24		dB
			1.00 GHz		0.23		dB
			1.50 GHz		0.29		dB
			2.00 GHz		0.36		dB
			2.50 GHz		0.42		dB
Isolation, TX to RX ports	ISO _{TX-RX}	V _{PIN_2} = 1 V, I _{PIN_14} = -50 mA, I _{PIN_9} = -50 mA, V _{PIN_7} = 28 V, TX port P _{IN} @ pin 14 = 0 dBm:					
			0.05 GHz		50	39	dB
			0.50 GHz		44		dB
			1.00 GHz		49		dB
			1.50 GHz		54		dB
			2.00 GHz		42		dB
			2.50 GHz		36		dB
Isolation, ANT to TX ports	ISO _{ANT-TX}	V _{PIN_2} = 1 V, V _{PIN_14} = 28 V, I _{PIN_7} = -50 mA, V _{PIN_9} = 28 V, ANT port P _{IN} @ pin 2 = 0 dBm:					
			0.05 GHz		50	27	dB
			0.50 GHz		31		dB
			1.00 GHz		25		dB
			1.50 GHz		22		dB
			2.00 GHz		21		dB
			2.50 GHz		20		dB
Isolation, ANT to RX ports	ISO _{ANT-RX}	V _{PIN_2} = 1 V, I _{PIN_14} = -50 mA, I _{PIN_9} = -50 mA, V _{PIN_7} = 28 V, ANT port P _{IN} @ pin 2 = 0 dBm:					
			0.05 GHz		51	39	dB
			0.50 GHz		44		dB
			1.00 GHz		47		dB
			1.50 GHz		48		dB
			2.00 GHz		40		dB
			2.50 GHz		35		dB

Table 6. SKY12208-478LF Electrical Specifications, Bias Voltage = 28 V (2 of 2) (Note 1)
(T_{OP} = +25 °C, Characteristic Impedance [Z₀] = 50 Ω, EVB Optimized for 0.05 to 2.70 GHz Operation, Unless Otherwise Noted)

Parameter	Symbol	Test Condition	Min	Typical	Max	Units
Input return loss		0.05 to 2.70 GHz: RX insertion loss state, ANT port (@ pin 2)		21		dB
		TX insertion loss state, TX port (@ pin 14)		20		dB
Transmit 2 nd harmonic	2fo	TX insertion loss state, TX port P _{IN} @ pin 14 = +30 dBm:				
		0.05 GHz		-81		dBc
		0.50 GHz		-95		dBc
		1.00 GHz		-89		dBc
		1.50 GHz		-94		dBc
		2.00 GHz		-85		dBc
2.50 GHz		-84		dBc		
Transmit 3 rd harmonic	3fo	TX insertion loss state, TX port P _{IN} @ pin 14 = +30 dBm:				
		0.05 GHz		-95		dBc
		0.50 GHz		-100		dBc
		1.00 GHz		-98		dBc
		1.50 GHz		-93		dBc
		2.00 GHz		-103		dBc
2.50 GHz		-102		dBc		
Transmit 3 rd Order Input Intercept Point	IIP3	V _{PIN_2} = 1 V, I _{PIN_14} = -50 mA, I _{PIN_9} = -50 mA, V _{PIN_7} = 28 V, TX port P _{IN} @ pin 14 = +30 dBm/tone, tone spacing = 1 MHz, @ 2.0 GHz		+77		dBm
Maximum transmit CW input power	P _{IN_CW}	V _{PIN_2} = 1 V, I _{PIN_14} = -50 mA, I _{PIN_9} = -50 mA, V _{PIN_7} = 28 V, 2.0 GHz		50		W
Maximum receive CW input power	P _{IN_CW}	V _{PIN_2} = 1 V, V _{PIN_14} = 28 V, I _{PIN_7} = 50 mA, V _{PIN_9} = 28 V, 2.0 GHz		40		W
Transmit RF switching time	t _{sw}	10% to 90% RF on, repetition rate = 0.1 MHz, @ 2.0 GHz		85		ns

Note 1: Performance is guaranteed only under the conditions listed in this Table.

Table 7. SKY12208-478LF Electrical Specifications, Bias Voltage = 5 V (1 of 2) (Note 1)
(T_{OP} = +25 °C, Characteristic Impedance [Z₀] = 50 Ω, EVB Optimized for 0.05 to 2.70 GHz Operation, Unless Otherwise Noted)

Parameter	Symbol	Test Condition	Min	Typical	Max	Units
Insertion loss, TX to ANT ports	IL _{TX-ANT}	V _{PIN_2} = 1 V, I _{PIN_14} = -50 mA, I _{PIN_9} = -50 mA, V _{PIN_7} = 5 V, TX port P _{IN} @ pin 14 = 0 dBm:			0.50	0.05 GHz
						0.61
						0.50 GHz
						0.20
						1.00 GHz
						0.21
						1.50 GHz
0.24						
2.00 GHz						
0.29						
2.50 GHz						
0.37						
Insertion loss, ANT to RX ports	IL _{ANT-RX}	V _{PIN_2} = 1 V, V _{PIN_14} = 5 V, I _{PIN_7} = -50 mA, V _{PIN_9} = 5 V, ANT port P _{IN} @ pin 2 = 0 dBm:			0.50	0.05 GHz
						0.60
						0.50 GHz
						0.19
						1.00 GHz
						0.22
						1.50 GHz
0.27						
2.00 GHz						
0.33						
2.50 GHz						
0.41						
Isolation, TX to RX ports	ISO _{TX-RX}	V _{PIN_2} = 1 V, I _{PIN_14} = -50 mA, I _{PIN_9} = -50 mA, V _{PIN_7} = 5 V, TX port P _{IN} @ pin 14 = 0 dBm:	39			0.05 GHz
						50
						0.50 GHz
						45
						1.00 GHz
						48
						1.50 GHz
55						
2.00 GHz						
41						
2.50 GHz						
35						
Isolation, ANT to TX ports	ISO _{ANT-TX}	V _{PIN_2} = 1 V, V _{PIN_14} = 5 V, I _{PIN_7} = -50 mA, V _{PIN_9} = 5 V, ANT port P _{IN} @ pin 2 = 0 dBm:	27			0.05 GHz
						51
						0.50 GHz
						31
						1.00 GHz
						25
						1.50 GHz
22						
2.00 GHz						
21						
2.50 GHz						
19						
Isolation, ANT to RX ports	ISO _{ANT-RX}	V _{PIN_2} = 1 V, I _{PIN_14} = -50 mA, I _{PIN_9} = -50 mA, V _{PIN_7} = 5 V, ANT port P _{IN} @ pin 2 = 0 dBm:	39			0.05 GHz
						48
						0.50 GHz
						43
						1.00 GHz
						46
						1.50 GHz
47						
2.00 GHz						
40						
2.50 GHz						
34						

Table 7. SKY12208-478LF Electrical Specifications, Bias Voltage = 5 V (2 of 2) (Note 1)
(T_{OP} = +25 °C, Characteristic Impedance [Z₀] = 50 Ω, EVB Optimized for 0.05 to 2.70 GHz Operation, Unless Otherwise Noted)

Parameter	Symbol	Test Condition	Min	Typical	Max	Units
Input return loss		0.05 to 2.70 GHz: RX insertion loss state, ANT port (@ pin 2)		21		dB
		TX insertion loss state, TX port (@ pin 14)		20		dB
Transmit 2 nd harmonic	2fo	TX insertion loss state, TX port P _{IN} @ pin 14 = +30 dBm:				
		0.05 GHz		-25		dBc
		0.50 GHz		-40		dBc
		1.00 GHz		-50		dBc
		1.50 GHz		-55		dBc
		2.00 GHz		-52		dBc
2.50 GHz		-45		dBc		
Transmit 3 rd harmonic	3fo	TX insertion loss state, TX port P _{IN} @ pin 14 = +30 dBm:				
		0.05 GHz		-36		dBc
		0.50 GHz		-49		dBc
		1.00 GHz		-60		dBc
		1.50 GHz		-65		dBc
		2.00 GHz		-68		dBc
2.50 GHz		-45		dBc		
Transmit 3 rd Order Input Intercept Point	IIP3	V _{PIN_2} = 1 V, I _{PIN_14} = -50 mA, I _{PIN_9} = -50 mA, V _{PIN_7} = 5 V, TX port P _{IN} @ pin 14 = +30 dBm/tone, tone spacing = 1 MHz, @ 2.0 GHz		+56		dBm
Maximum transmit CW input power	P _{IN_CW}	V _{PIN_2} = 1 V, I _{PIN_14} = -50 mA, I _{PIN_9} = -50 mA, V _{PIN_7} = 5 V, 2.0 GHz		15		W
Maximum receive CW input power	P _{IN_CW}	V _{PIN_2} = 1 V, V _{PIN_14} = 5 V, I _{PIN_7} = 50 mA, V _{PIN_9} = 5 V, 2.0 GHz		10		W
Transmit RF switching time	t _{sw}	10% to 90% RF on, repetition rate = 0.1 MHz, @ 2.0 GHz		85		ns

Note 1: Performance is guaranteed only under the conditions listed in this Table.

Typical Performance Characteristics

($T_{OP} = +25\text{ }^{\circ}\text{C}$, Characteristic Impedance [Z_0] = 50 Ω , EVB Optimized for 0.02 to 0.70 GHz Operation, Unless Otherwise Noted)

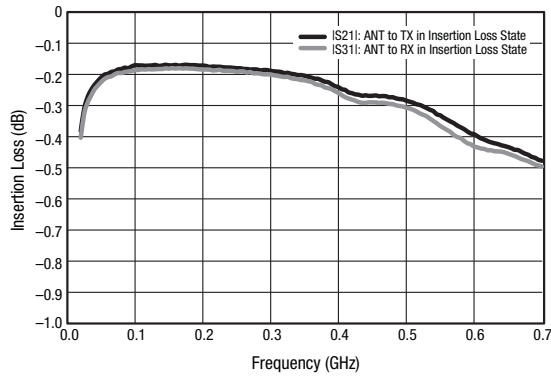

Figure 3. Insertion Loss vs Frequency
(ANT to RX and ANT to TX Ports; $V_{CTL} = 28\text{ V}$, $I_{CTL} = -50\text{ mA}$)

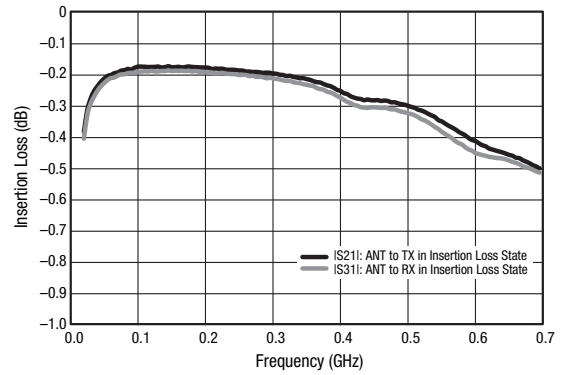

Figure 4. Insertion Loss vs Frequency
(ANT to RX and ANT to TX Ports; $V_{CTL} = 5\text{ V}$, $I_{CTL} = -50\text{ mA}$)

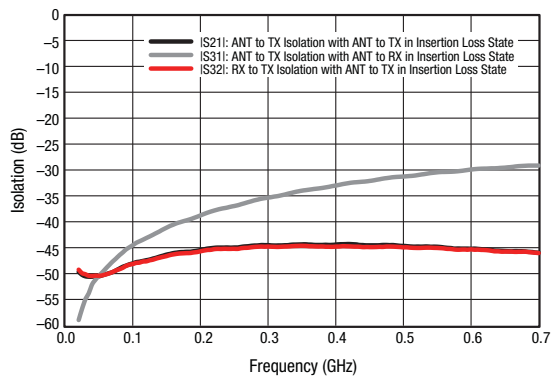

Figure 5. Isolation vs Frequency
(ANT to RX, TX to RX, and ANT to TX Ports;
 $V_{CTL} = 28\text{ V}$, $I_{CTL} = -50\text{ mA}$)

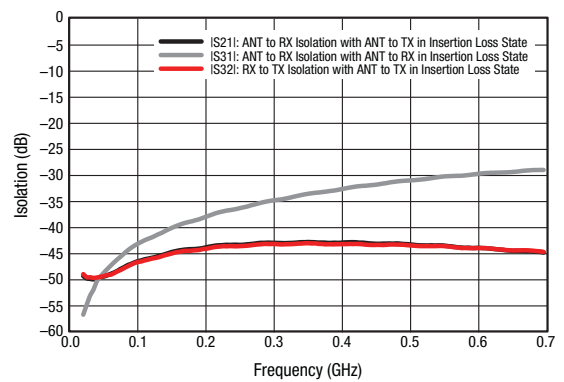

Figure 6. Isolation vs Frequency
(ANT to RX, TX to RX, and ANT to TX Ports;
 $V_{CTL} = 5\text{ V}$, $I_{CTL} = -50\text{ mA}$)

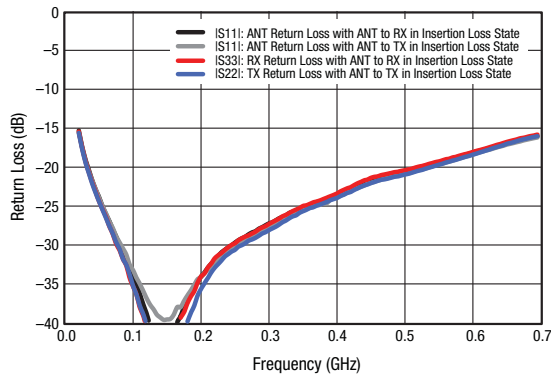

Figure 7. Return Loss vs Frequency
(ANT, TX, and RX Ports; $V_{CTL} = 28\text{ V}$, $I_{CTL} = -50\text{ mA}$)

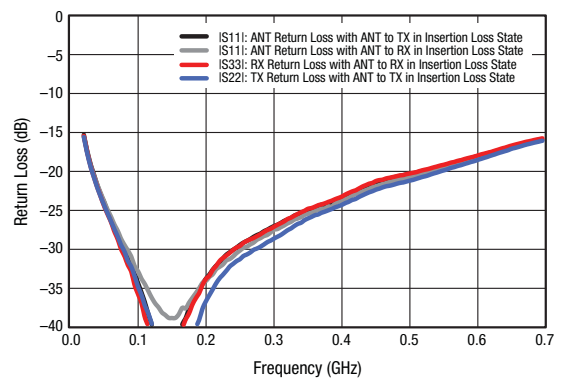

Figure 8. Return Loss vs Frequency
(ANT, TX, and RX Ports; $V_{CTL} = 5\text{ V}$, $I_{CTL} = -50\text{ mA}$)

Typical Performance Characteristics

($T_{OP} = +25\text{ }^{\circ}\text{C}$, Characteristic Impedance [Z_0] = 50 Ω , EVB Optimized for 0.05 to 2.70 GHz Operation, Unless Otherwise Noted)

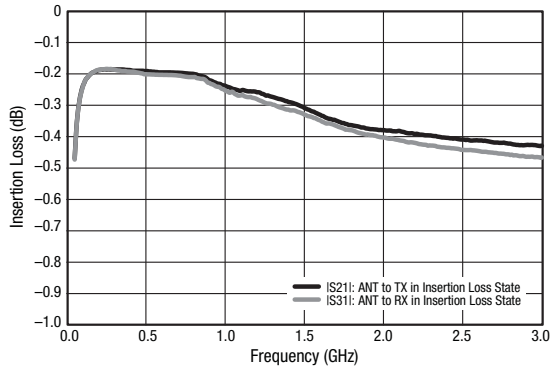

Figure 9. Insertion Loss vs Frequency
(ANT to RX and ANT to TX Ports; $V_{CTL} = 28\text{ V}$, $I_{CTL} = -50\text{ mA}$)

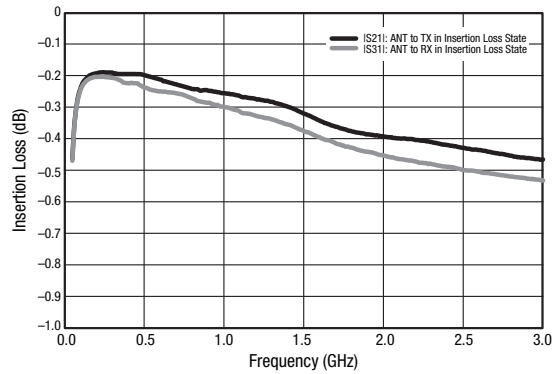

Figure 10. Insertion Loss vs Frequency
(ANT to RX and ANT to TX Ports; $V_{CTL} = 5\text{ V}$, $I_{CTL} = -50\text{ mA}$)

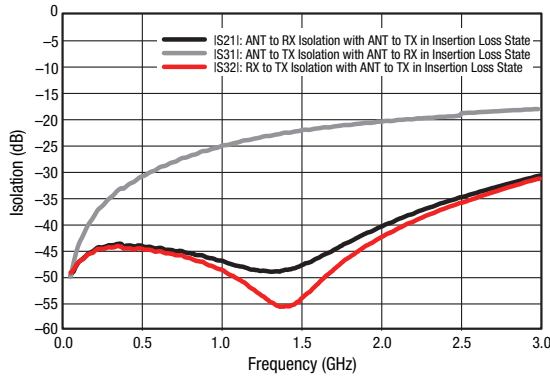

Figure 11. Isolation vs Frequency
(ANT to RX, TX to RX, and ANT to TX Ports;
 $V_{CTL} = 28\text{ V}$, $I_{CTL} = -50\text{ mA}$)

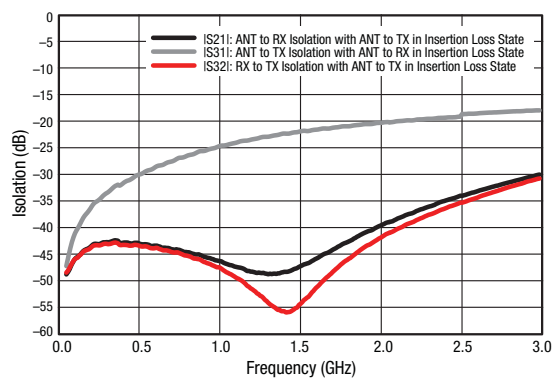

Figure 12. Isolation vs Frequency
(ANT to RX, TX to RX, and ANT to TX Ports;
 $V_{CTL} = 5\text{ V}$, $I_{CTL} = -50\text{ mA}$)

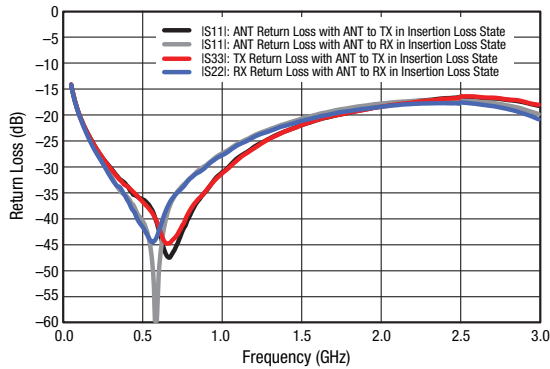

Figure 13. Return Loss vs Frequency
(ANT, TX, and RX Ports; $V_{CTL} = 28\text{ V}$, $I_{CTL} = -50\text{ mA}$)

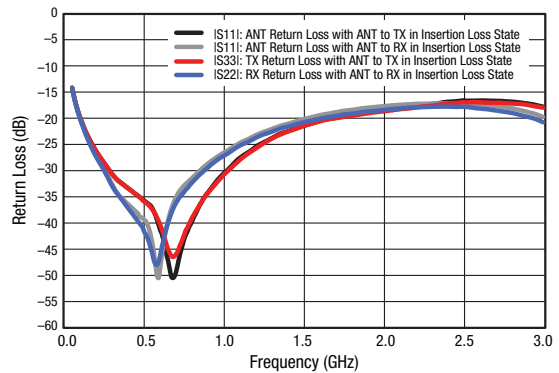

Figure 14. Return Loss vs Frequency
(ANT, TX, and RX Ports; $V_{CTL} = 5\text{ V}$, $I_{CTL} = -50\text{ mA}$)

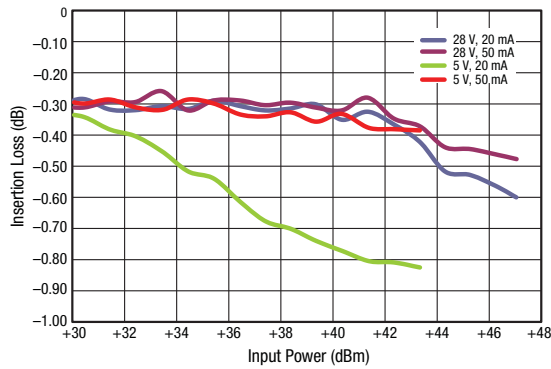

Figure 15. Insertion Loss vs CW Input Power (ANT to RX Port, f = 0.25 GHz)

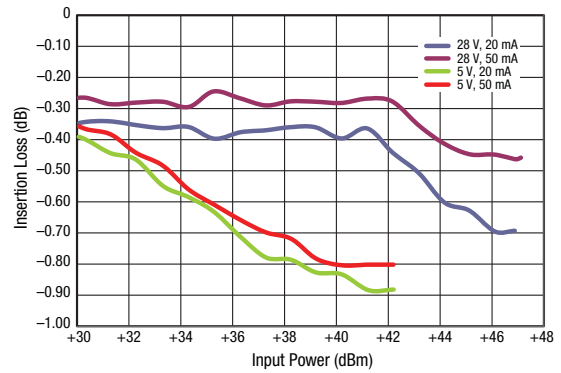

Figure 16. Insertion Loss vs CW Input Power (TX to ANT Port, f = 0.25 GHz)

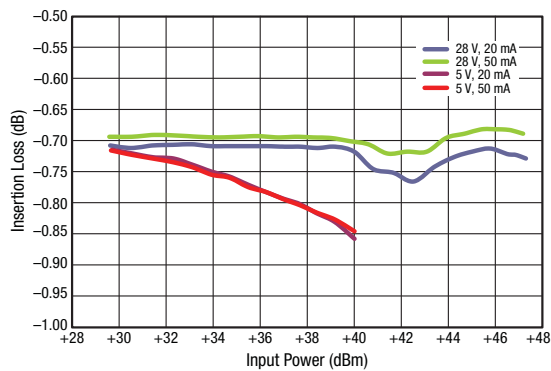

Figure 17. Insertion Loss vs CW Input Power (ANT to RX Port, f = 2.0 GHz)

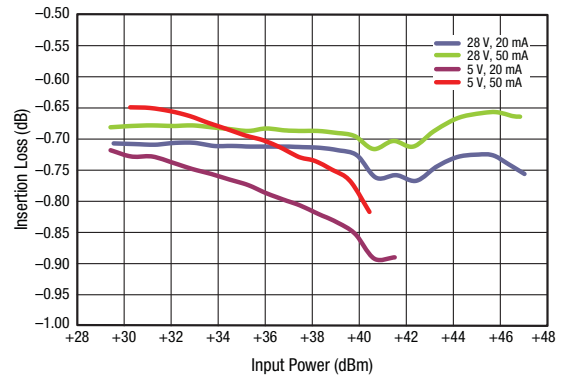

Figure 18. Insertion Loss vs CW Input Power (TX to ANT Port, f = 2.0 GHz)

Table 8. SKY12208-478LF Truth Table

Switch State	Path		Control Conditions			
	Antenna-to-Receiver Port (Pin 2 to Pin 7)	Transmitter-to-Antenna Port (Pin 14 to Pin 2)	Antenna Port Bias Input (Pin 2)	Nominal Receiver Output Port (Pin 7)	Nominal Transmitter Port Bias Input (Pin 14)	RX_BIAS Input (Pin 9)
Receive (see Figure 21)	Low insertion loss	High isolation	1 V	-50 mA	28 V	28 V
Transmit (see Figure 21)	High isolation	Low insertion loss	1 V	28 V	-50 mA	-50 mA

Table 9. SKY12208-478LF Evaluation Board Truth Table

Switch State	Path		Control Conditions			
	Antenna-to-Receiver Port	Transmitter-to-Antenna Port	Antenna Port Bias Input	Receiver Output Port	Transmitter Port Bias Input	RX_BIAS Input
Receive (see Figure 21)	Low insertion loss	High isolation	5 V	0 V (ground)	28 V	28 V
Transmit (see Figure 21)	High isolation	Low insertion loss	5 V	28 V	0 V (ground)	0 V (ground)

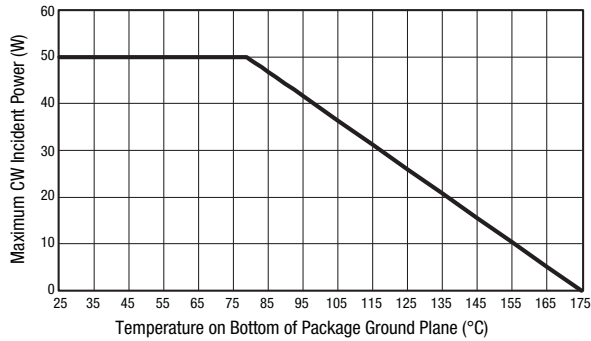

Figure 19. Transmit Power Derating, Maximum CW Incident Power (Insertion Loss = 0.3 dB) vs Temperature on Bottom of Package Ground Plane

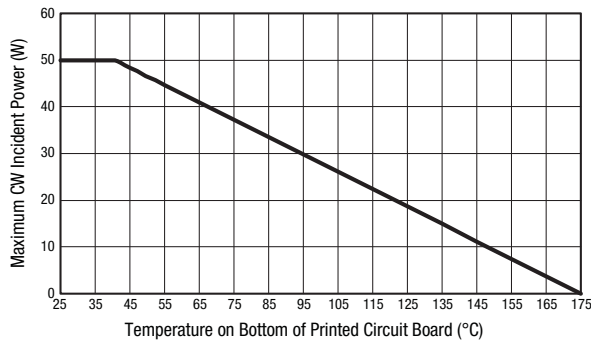

Figure 20. Transmit Power Derating, Maximum CW Incident Power (Insertion Loss = 0.3 dB) vs Temperature on Bottom of Printed Circuit Board

Evaluation Board Description

The SKY12208-478LF Evaluation Board is used to test the performance of the SKY12208-478LF PIN Diode SPDT switch. An assembly drawing for the Evaluation Board is shown in Figure 22. The layer detail is provided in Figure 23.

The SKY12208-478LF is designed to handle very large signals. Sufficient power may be dissipated by this switch to cause heating of the PIN diodes contained in the switch. It is very important to use a printed circuit board design that provides adequate cooling capability to keep the junction temperature of the PIN diodes below their maximum rated operating temperature.

As indicated in Figure 19, the x-axis temperature is referenced to the bottom of the QFN package. A printed circuit board with a very low thermal resistance and external heat sink design must be used to achieve the results shown in this Figure. The power derating curve with the x-axis temperature referenced to the bottom of the printed circuit board is provided in Figure 20.

The evaluation circuit is designed to facilitate control of the SKY12208-478LF transmit/receive switch with bias signals

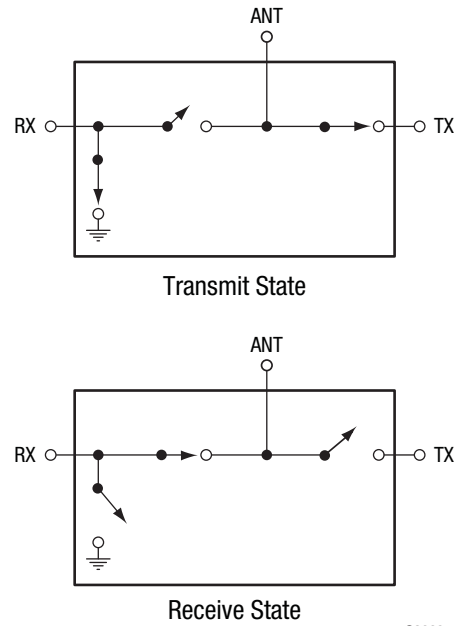

S2398

Figure 21. SKY12208-478LF Equivalent Circuit Diagrams

derived from positive voltages. The state of the PIN diodes within the SKY12208-478LF is controlled with 5 V applied to the ANT port and bias voltages of either 28 V or 0 V applied to the remaining bias inputs (RX and TX ports). The switch state circuit diagrams are shown in Figure 21.

The value of resistor R1 (80 Ω) is selected to provide 50 mA of forward current through the "on" series diode with 5 V applied to the ANT port bias pin. The R2 resistance value of 540 Ω is selected to produce approximately 50 mA of forward bias current in the RX shunt diode with a source voltage of 28 V.

The magnitudes of the voltages applied to the TX and RX ports determine which of the RX or TX series diodes is biased into forward conduction. For example, to place the SKY12208-478LF into the transmit state, 0 V is applied to the TX port (which forward biases the diode between pins 2 and 14), 28 V is applied to the RX port (which reverse biases the diode between pins 2 and 7), and 0 V is applied to the RX_BIAS port (which applies a forward bias through R2 to the diode connected between pins 7 and 9).

The component values shown in the Evaluation Board circuit diagram (Figure 24) were selected to optimize performance in the 0.02 to 0.70 GHz and 0.05 to 2.7 GHz bands.

Refer to Table 10 for the Evaluation Board Bill of Materials. Table 11 provides voltage, current, and resistor values for bias adjustments.

Package Dimensions

The PCB layout footprint for the SKY12208-478LF is shown in Figure 25. Typical case markings are noted in Figure 26. Package dimensions for the 16-pin QFN are shown in Figure 27, and tape and reel dimensions are provided in Figure 28.

Package and Handling Information

Instructions on the shipping container label regarding exposure to moisture after the container seal is broken must be followed. Otherwise, problems related to moisture absorption may occur when the part is subjected to high temperature during solder assembly.





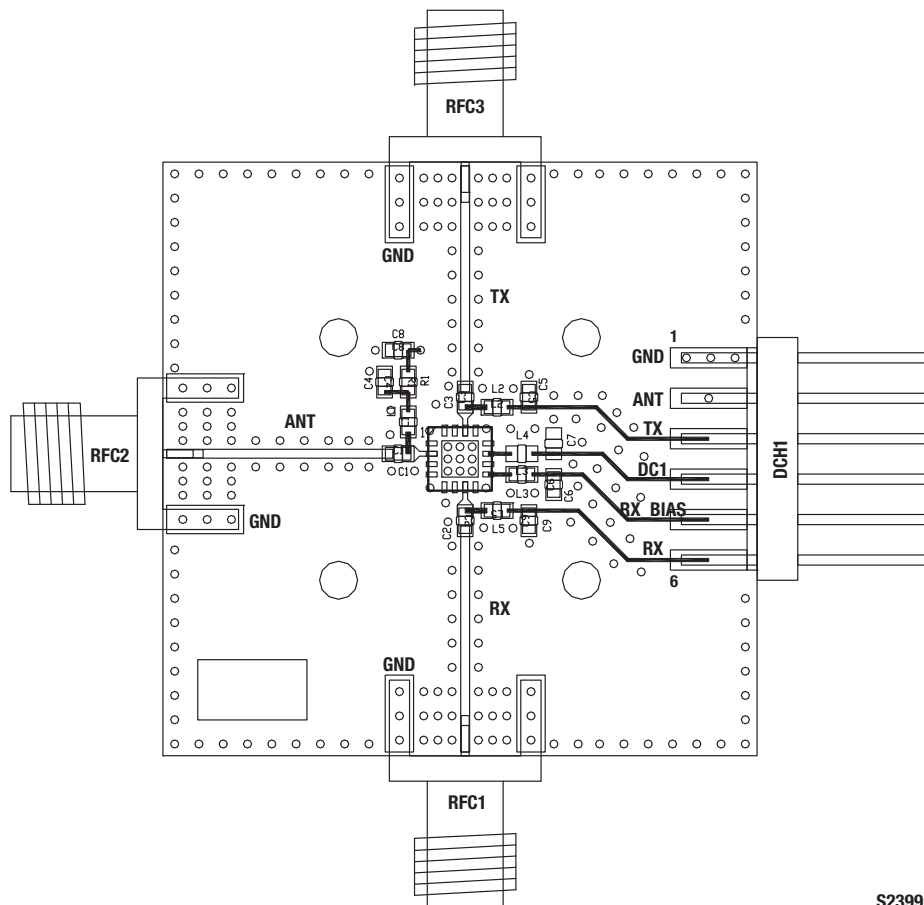



The SKY12208-478LF is rated to Moisture Sensitivity Level 1 (MSL1) at 260 °C. It can be used for lead or lead-free soldering. For additional information, refer to the Skyworks Application Note, *Solder Reflow Information*, document number 200164.

Care must be taken when attaching this product, whether it is done manually or in a production solder reflow environment. Production quantities of this product are shipped in a standard tape and reel format.

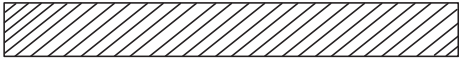

S2399

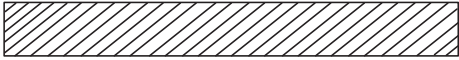
Figure 22. SKY12208-478LF Evaluation Board Assembly Diagram

Cross Section	Name	Thickness (in)	Material
	Top Soldermask		
	L1	(0.0028)	Cu foil
	Laminate	0.012 ± 0.0006	Rogers R04003C Core
	L2	(0.0014)	Cu foil
	Laminate	(Note 1)	FR4 Prepreg
	L3	(0.0014)	Cu foil
	Laminate	0.010 ± 0.0006	FR4 Core
	L4	(0.0028)	Cu foil
	Bottom Soldermask		

Note 1: Adjust this thickness to meet total thickness goal of 0.062 ± 0.005 inches.

S2531

Figure 23. Layer Detail Physical Characteristics

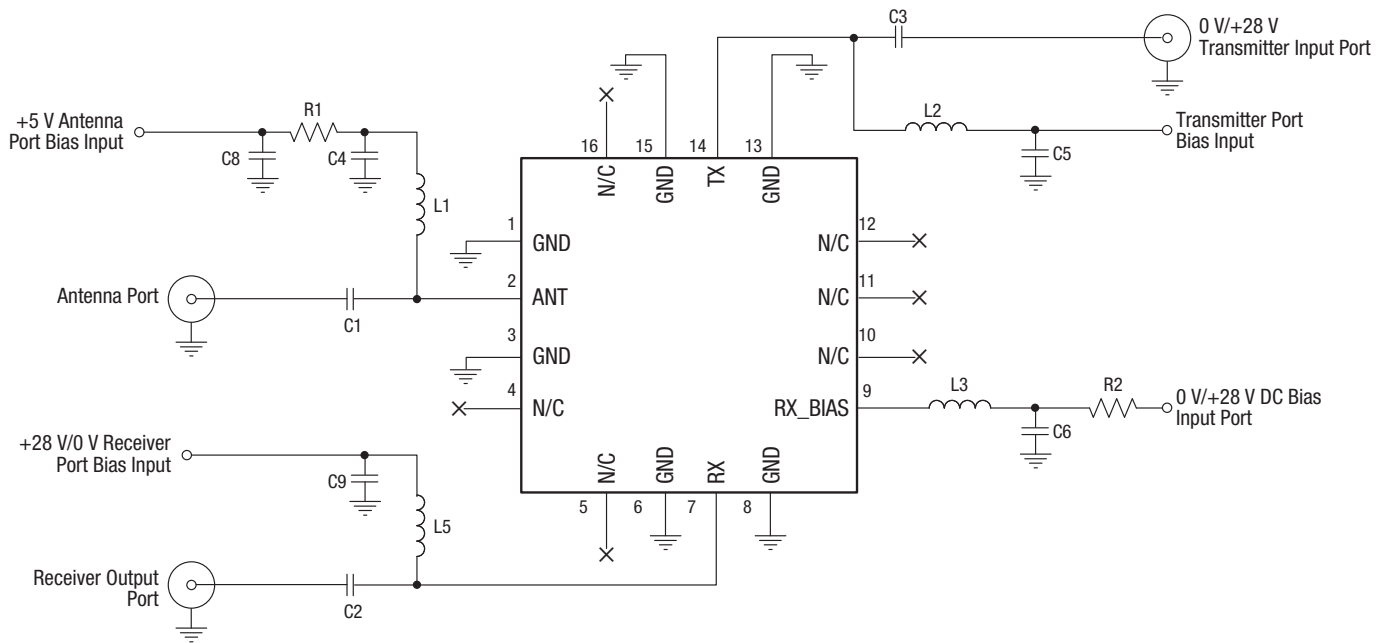

NOTE: The N/C pins (4, 5, 10, 11, 12, and 16) are not internally connected, so they can be left open or grounded.

S2402

Figure 24. Evaluation Board Schematic

Table 10. Evaluation Board Bill of Materials (Note 1)

Component	Value	Size	Product Number	Manufacturer	Mfr Part Number	Characteristics
C1, C2, C3, C4, C5, C6, C9	1000 pF	0603	5404R23-057	TDK	C1608C0G1H102JT	COG, 50 V, ±5%
C8	1 μF	0603	5404R29-070	TDK	C2012X7R1H104K	X7R, 50 V, ±10%
L1, L2, L5 (for 0.02 to 0.7 GHz operation)	1200 nH	0603	–	Coil Craft	0603LS-122XJLB	SRF, 160 MHz, ±5%
L1, L2, L5 (for 0.05 to 2.7 GHz operation)	820 nH	0603	–	Coil Craft	0603LS-821XJLB	SRF, 410 MHz, ±5%
L3	560 nH	0603	–	Coil Craft	0603LS-561XJLB	SRF, 525 MHz, ±5%
R1 (Note 2)	80 Ω	0603	–	Panasonic	ERJ-3GEYJ161V	0.1 W, ±5%
R2 (Note 3)	540 Ω	–	–	–	–	Axial leaded (off board)

Note 1: Component values selected are based on the desired frequency and bias level. Values may be adjusted for a specific response.

Note 2: Two 160 Ω resistors are combined in parallel to achieve a minimum power handling requirement and 80 Ω resistance.

Note 3: Evaluation Board does not include resistor R2. Operating at 28 V and 50 mA requires resistor R2 with a power dissipation greater than 1.35 W.

Table 11. Component Calculation Values

Vs (V)	V _{DIODE} (V)	V _{RES} (V)	Current (A)	Resistance (Ω)	Power Dissipation (W)
28	1	27	0.05	540	1.35
28	1	27	0.02	1350	0.54
5	1	4	0.05	80	0.20
5	1	4	0.02	200	0.08

Notes: Vs = supply voltage; V_{DIODE} = voltage drop across the diode; V_{RES} = voltage drop across the resistor.

R1 and R2 values are calculated by (Vs – V_{DIODE})/I, where I is the desired bias current. The power dissipation in R1 or R2 is calculated by I x (Vs – V_{DIODE}). The resistor selected must be safely rated with a power greater than the dissipated power.

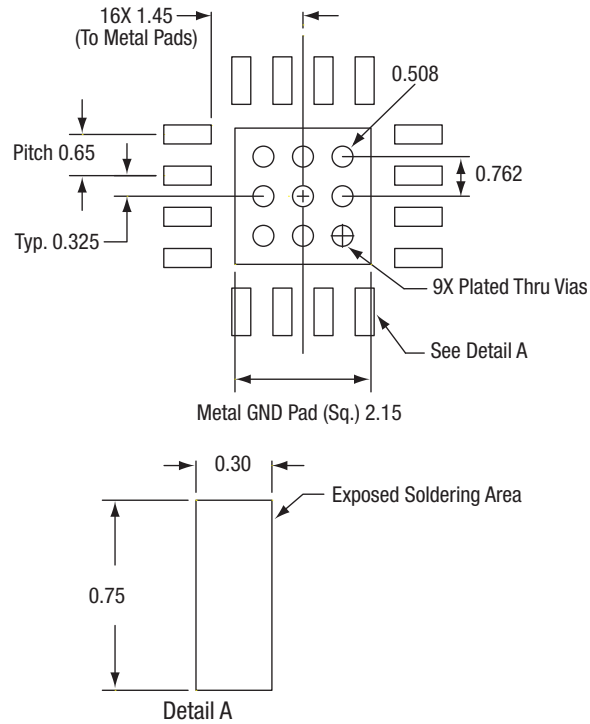

All measurements in millimeters

S2274

Figure 25. SKY12208-478LF PCB Layout Footprint

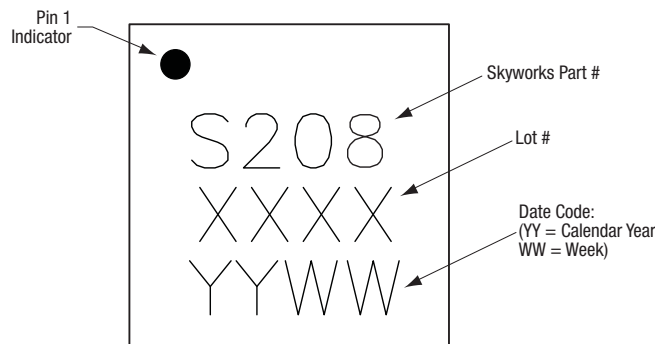
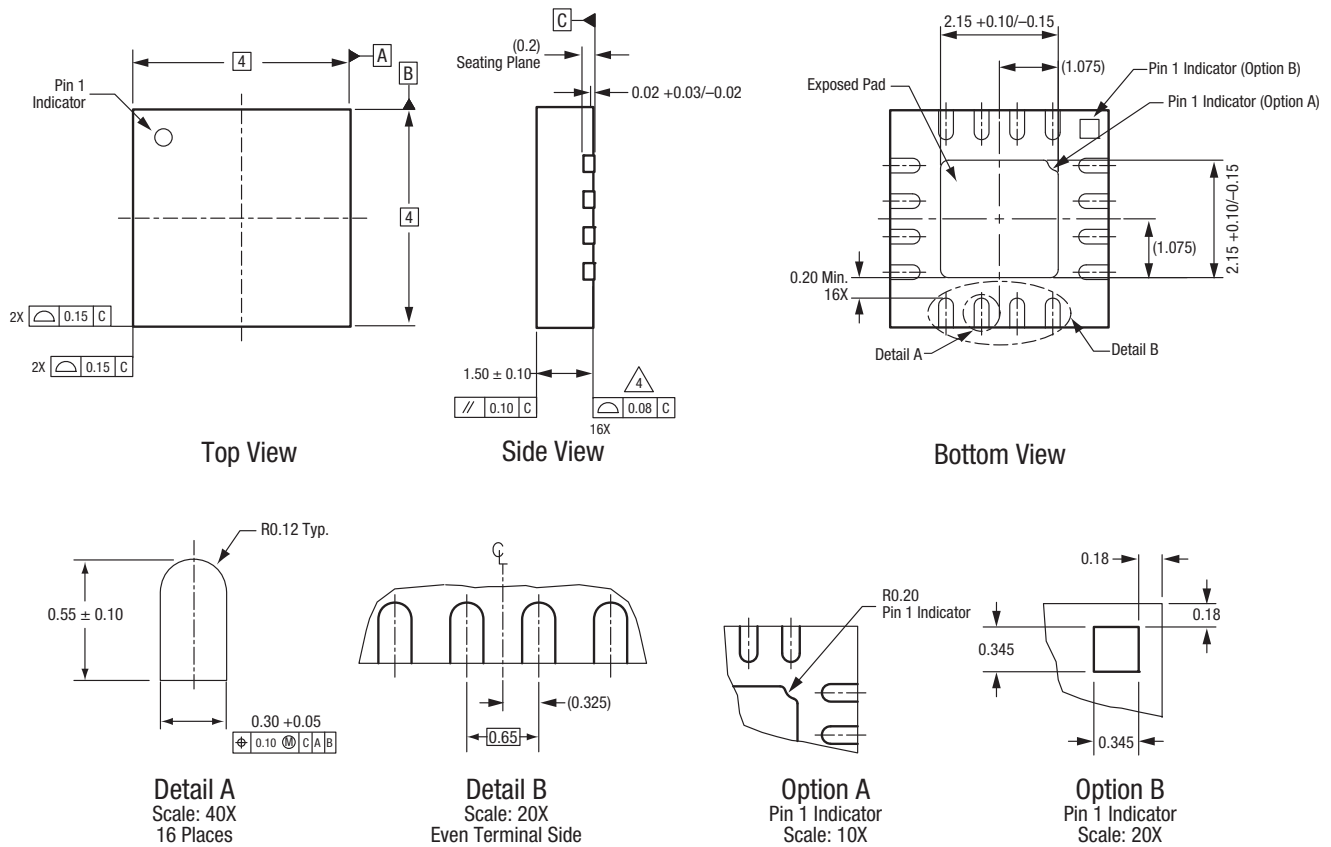

Figure 26. Typical Case Markings

DATA SHEET • SKY12208-478LF: 50 W PIN DIODE SPDT SWITCH



All measurements are in millimeters.
Dimensioning and tolerancing according to ASME Y14.5M-1994.
Coplanarity applies to the exposed heat sink slug as well as the terminals.
Package may have option A or option B pin 1 indicator.

S2400a

Figure 27. SKY12208-478LF 16-Pin QFN Package Dimensions

Ordering Information

Model Name	Manufacturing Part Number	Evaluation Board Part Number
SKY12208-478LF PIN Diode SPDT Switch	SKY12208-478LF	SKY12208-478LF-EVB

Copyright © 2011-2014 Skyworks Solutions, Inc. All Rights Reserved.

Information in this document is provided in connection with Skyworks Solutions, Inc. ("Skyworks") products or services. These materials, including the information contained herein, are provided by Skyworks as a service to its customers and may be used for informational purposes only by the customer. Skyworks assumes no responsibility for errors or omissions in these materials or the information contained herein. Skyworks may change its documentation, products, services, specifications or product descriptions at any time, without notice. Skyworks makes no commitment to update the materials or information and shall have no responsibility whatsoever for conflicts, incompatibilities, or other difficulties arising from any future changes.

No license, whether express, implied, by estoppel or otherwise, is granted to any intellectual property rights by this document. Skyworks assumes no liability for any materials, products or information provided hereunder, including the sale, distribution, reproduction or use of Skyworks products, information or materials, except as may be provided in Skyworks Terms and Conditions of Sale.

THE MATERIALS, PRODUCTS AND INFORMATION ARE PROVIDED "AS IS" WITHOUT WARRANTY OF ANY KIND, WHETHER EXPRESS, IMPLIED, STATUTORY, OR OTHERWISE, INCLUDING FITNESS FOR A PARTICULAR PURPOSE OR USE, MERCHANTABILITY, PERFORMANCE, QUALITY OR NON-INFRINGEMENT OF ANY INTELLECTUAL PROPERTY RIGHT; ALL SUCH WARRANTIES ARE HEREBY EXPRESSLY DISCLAIMED. SKYWORKS DOES NOT WARRANT THE ACCURACY OR COMPLETENESS OF THE INFORMATION, TEXT, GRAPHICS OR OTHER ITEMS CONTAINED WITHIN THESE MATERIALS. SKYWORKS SHALL NOT BE LIABLE FOR ANY DAMAGES, INCLUDING BUT NOT LIMITED TO ANY SPECIAL, INDIRECT, INCIDENTAL, STATUTORY, OR CONSEQUENTIAL DAMAGES, INCLUDING WITHOUT LIMITATION, LOST REVENUES OR LOST PROFITS THAT MAY RESULT FROM THE USE OF THE MATERIALS OR INFORMATION, WHETHER OR NOT THE RECIPIENT OF MATERIALS HAS BEEN ADVISED OF THE POSSIBILITY OF SUCH DAMAGE.

Skyworks products are not intended for use in medical, lifesaving or life-sustaining applications, or other equipment in which the failure of the Skyworks products could lead to personal injury, death, physical or environmental damage. Skyworks customers using or selling Skyworks products for use in such applications do so at their own risk and agree to fully indemnify Skyworks for any damages resulting from such improper use or sale.

Customers are responsible for their products and applications using Skyworks products, which may deviate from published specifications as a result of design defects, errors, or operation of products outside of published parameters or design specifications. Customers should include design and operating safeguards to minimize these and other risks. Skyworks assumes no liability for applications assistance, customer product design, or damage to any equipment resulting from the use of Skyworks products outside of stated published specifications or parameters.

Skyworks, the Skyworks symbol, and "Breakthrough Simplicity" are trademarks or registered trademarks of Skyworks Solutions, Inc., in the United States and other countries. Third-party brands and names are for identification purposes only, and are the property of their respective owners. Additional information, including relevant terms and conditions, posted at www.skyworksinc.com, are incorporated by reference.

Компания «Океан Электроники» предлагает заключение долгосрочных отношений при поставках импортных электронных компонентов на взаимовыгодных условиях!

Наши преимущества:

- Поставка оригинальных импортных электронных компонентов напрямую с производств Америки, Европы и Азии, а так же с крупнейших складов мира;
- Широкая линейка поставок активных и пассивных импортных электронных компонентов (более 30 млн. наименований);
- Поставка сложных, дефицитных, либо снятых с производства позиций;
- Оперативные сроки поставки под заказ (от 5 рабочих дней);
- Экспресс доставка в любую точку России;
- Помощь Конструкторского Отдела и консультации квалифицированных инженеров;
- Техническая поддержка проекта, помощь в подборе аналогов, поставка прототипов;
- Поставка электронных компонентов под контролем ВП;
- Система менеджмента качества сертифицирована по Международному стандарту ISO 9001;
- При необходимости вся продукция военного и аэрокосмического назначения проходит испытания и сертификацию в лаборатории (по согласованию с заказчиком);
- Поставка специализированных компонентов военного и аэрокосмического уровня качества (Xilinx, Altera, Analog Devices, Intersil, Interpoint, Microsemi, Actel, Aeroflex, Peregrine, VPT, Syfer, Eurofarad, Texas Instruments, MS Kennedy, Miteq, Cobham, E2V, MA-COM, Hittite, Mini-Circuits, General Dynamics и др.);

Компания «Океан Электроники» является официальным дистрибьютором и эксклюзивным представителем в России одного из крупнейших производителей разъемов военного и аэрокосмического назначения «JONHON», а так же официальным дистрибьютором и эксклюзивным представителем в России производителя высокотехнологичных и надежных решений для передачи СВЧ сигналов «FORSTAR».



JONHON

«JONHON» (основан в 1970 г.)

Разъемы специального, военного и аэрокосмического назначения:

(Применяются в военной, авиационной, аэрокосмической, морской, железнодорожной, горно- и нефтедобывающей отраслях промышленности)

«FORSTAR» (основан в 1998 г.)

ВЧ соединители, коаксиальные кабели, кабельные сборки и микроволновые компоненты:

(Применяются в телекоммуникациях гражданского и специального назначения, в средствах связи, РЛС, а так же военной, авиационной и аэрокосмической отраслях промышленности).



Телефон: 8 (812) 309-75-97 (многоканальный)

Факс: 8 (812) 320-03-32

Электронная почта: ocean@oceanchips.ru

Web: <http://oceanchips.ru/>

Адрес: 198099, г. Санкт-Петербург, ул. Калинина, д. 2, корп. 4, лит. А