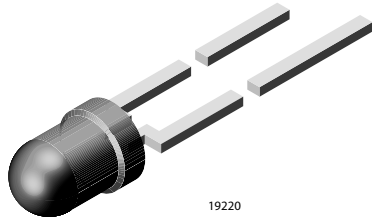


## High Efficiency LED, Ø 3 mm Tinted Total Diffused Package



### FEATURES

- Choice of three bright colors
- Standard Ø 3 (T-1) package
- Small mechanical tolerances
- Suitable for DC and high peak current
- Very wide viewing angle
- Luminous intensity categorized
- Yellow and green color categorized
- Compliant to RoHS Directive 2002/95/EC and in accordance to WEEE 2002/96/EC



### DESCRIPTION

The TLH.46.. series was developed for applications which need a very wide radiation angle like backlighting, general indicating and lighting purposes. It is housed in a 3 mm tinted total diffused plastic package. The wide viewing angle of these devices provides a high on-off contrast.

Several selection types with different luminous intensities are offered. All LEDs are categorized in luminous intensity groups. The green and yellow LEDs are categorized additionally in wavelength groups.

That allows users to assemble LEDs with uniform appearance.

### APPLICATIONS

- Status lights
- Off/on indicator
- Background illumination
- Readout lights
- Maintenance lights
- Legend light

### PRODUCT GROUP AND PACKAGE DATA

- Product group: LED
- Package: 3 mm
- Product series: standard
- Angle of half intensity:  $\pm 60^\circ$

PARTS TABLE		
PART	COLOR, LUMINOUS INTENSITY	TECHNOLOGY
TLHR4600	Red, $I_V > 1$ mcd	GaAsP on GaP
TLHR4605	Red, $I_V > 2.5$ mcd	GaAsP on GaP
TLHR4605-MS12Z	Red, $I_V > 2.5$ mcd	GaAsP on GaP
TLHY4600	Yellow, $I_V > 0.63$ mcd	GaAsP on GaP
TLHY4600-AS12	Yellow, $I_V > 0.63$ mcd	GaAsP on GaP
TLHY4601	Yellow, $I_V > 1$ mcd	GaAsP on GaP
TLHY4605	Yellow, $I_V > 2.5$ mcd	GaAsP on GaP
TLHY4605-AS12Z	Yellow, $I_V > 2.5$ mcd	GaAsP on GaP
TLHY4605-CS12Z	Yellow, $I_V > 2.5$ mcd	GaAsP on GaP
TLHY4605-MS12Z	Yellow, $I_V > 2.5$ mcd	GaAsP on GaP
TLHG4600	Green, $I_V > 1$ mcd	GaP on GaP
TLHG4601-AS21	Green, $I_V > 1.6$ mcd	GaP on GaP
TLHG4605	Green, $I_V > 4$ mcd	GaP on GaP
TLHG4605-AS12Z	Green, $I_V > 4$ mcd	GaP on GaP
TLHG4605-MS21Z	Green, $I_V > 4$ mcd	GaP on GaP

\*\* Please see document "Vishay Material Category Policy": [www.vishay.com/doc?99902](http://www.vishay.com/doc?99902)

**ABSOLUTE MAXIMUM RATINGS** ( $T_{amb} = 25\text{ }^{\circ}\text{C}$ , unless otherwise specified)  
**TLHR460., TLHY460., TLHG460.**

PARAMETER	TEST CONDITION	SYMBOL	VALUE	UNIT
Reverse voltage		$V_R$	6	V
DC Forward current	$T_{amb} \leq 60\text{ }^{\circ}\text{C}$	$I_F$	30	mA
Surge forward current	$t_p \leq 10\text{ }\mu\text{s}$	$I_{FSM}$	1	A
Power dissipation	$T_{amb} \leq 60\text{ }^{\circ}\text{C}$	$P_V$	100	mW
Junction temperature		$T_j$	100	$^{\circ}\text{C}$
Operating temperature range		$T_{amb}$	- 20 to + 100	$^{\circ}\text{C}$
Storage temperature range		$T_{stg}$	- 55 to + 100	$^{\circ}\text{C}$
Soldering temperature	$t \leq 5\text{ s}$ , 2 mm from body	$T_{sd}$	260	$^{\circ}\text{C}$
Thermal resistance junction/ambient		$R_{thJA}$	400	K/W

**OPTICAL AND ELECTRICAL CHARACTERISTICS** ( $T_{amb} = 25\text{ }^{\circ}\text{C}$ , unless otherwise specified)  
**TLHR460., RED**

PARAMETER	TEST CONDITION	PART	SYMBOL	MIN.	TYP.	MAX.	UNIT
Luminous intensity <sup>1)</sup>	$I_F = 10\text{ mA}$	TLHR4600	$I_V$	1	4		mcd
		TLHR4605	$I_V$	2.5	6		mcd
Dominant wavelength	$I_F = 10\text{ mA}$		$\lambda_d$	612		625	nm
Peak wavelength	$I_F = 10\text{ mA}$		$\lambda_p$		635		nm
Angle of half intensity	$I_F = 10\text{ mA}$		$\varphi$		$\pm 60$		deg
Forward voltage	$I_F = 20\text{ mA}$		$V_F$		2	3	V
Reverse voltage	$I_R = 10\text{ }\mu\text{A}$		$V_R$	6	15		V
Junction capacitance	$V_R = 0$ , $f = 1\text{ MHz}$		$C_j$		50		pF

Note:

<sup>1)</sup> In one packing unit  $I_{Vmin.}/I_{Vmax.} \leq 0.5$

**OPTICAL AND ELECTRICAL CHARACTERISTICS** ( $T_{amb} = 25\text{ }^{\circ}\text{C}$ , unless otherwise specified)  
**TLHY460., YELLOW**

PARAMETER	TEST CONDITION	PART	SYMBOL	MIN.	TYP.	MAX.	UNIT
Luminous intensity <sup>1)</sup>	$I_F = 10\text{ mA}$	TLHY4600	$I_V$	0.63	3.5		mcd
		TLHY4601	$I_V$	1	4		mcd
		TLHY4605	$I_V$	2.5	5		mcd
Dominant wavelength	$I_F = 10\text{ mA}$		$\lambda_d$	581		594	nm
Peak wavelength	$I_F = 10\text{ mA}$		$\lambda_p$		585		nm
Angle of half intensity	$I_F = 10\text{ mA}$		$\varphi$		$\pm 60$		deg
Forward voltage	$I_F = 20\text{ mA}$		$V_F$		2.4	3	V
Reverse voltage	$I_R = 10\text{ }\mu\text{A}$		$V_R$	6	15		V
Junction capacitance	$V_R = 0$ , $f = 1\text{ MHz}$		$C_j$		50		pF

Note:

<sup>1)</sup> In one packing unit  $I_{Vmin.}/I_{Vmax.} \leq 0.5$

**OPTICAL AND ELECTRICAL CHARACTERISTICS** ( $T_{amb} = 25\text{ }^{\circ}\text{C}$ , unless otherwise specified)  
**TLHG460., GREEN**

PARAMETER	TEST CONDITION	PART	SYMBOL	MIN.	TYP.	MAX.	UNIT
Luminous intensity <sup>1)</sup>	$I_F = 10\text{ mA}$	TLHG4600	$I_V$	1	4		mcd
		TLHG4601	$I_V$	1.6	3.5		mcd
		TLHG4605	$I_V$	4	6		mcd
Dominant wavelength	$I_F = 10\text{ mA}$		$\lambda_d$	562		575	nm
Peak wavelength	$I_F = 10\text{ mA}$		$\lambda_p$		565		nm
Angle of half intensity	$I_F = 10\text{ mA}$		$\phi$		$\pm 60$		deg
Forward voltage	$I_F = 20\text{ mA}$		$V_F$		2.4	3	V
Reverse voltage	$I_R = 10\text{ }\mu\text{A}$		$V_R$	6	15		V
Junction capacitance	$V_R = 0, f = 1\text{ MHz}$		$C_j$		50		pF

Note:

<sup>1)</sup> In one packing unit  $I_{Vmin}/I_{Vmax} \leq 0.5$ 
**LUMINOUS INTENSITY CLASSIFICATION**

GROUP	LIGHT INTENSITY (mcd)	
	MIN.	MAX.
STANDARD		
K	0.63	1.25
L	1	2
M	1.6	3.2
N	2.5	5
P	4	8
Q	6.3	12.5
R	10	20
S	16	32
T	25	50
U	40	80

Note:

 Luminous intensity is tested at a current pulse duration of 25 ms and an accuracy of  $\pm 11\%$ .

These type numbers represent the order groups which include only a few brightness groups. Only one group will be shipped on each bag (there will be no mixing of two groups on each bag).

In order to ensure availability, single brightness groups will not be orderable.

In a similar manner for colors where wavelength groups are measured and binned, single wavelength groups will be shipped on any one bag. In order to ensure availability, single wavelength groups will not be orderable.

**COLOR CLASSIFICATION**

GROUP	DOM. WAVELENGTH (nm)			
	YELLOW		GREEN	
	MIN.	MAX.	MIN.	MAX.
0				
1	581	584		
2	583	586		
3	585	588	562	565
4	587	590	564	567
5	589	592	566	569
6	591	594	568	571
7			570	573
8			572	575

Note:

Wavelengths are tested at a current pulse duration of 25 ms.

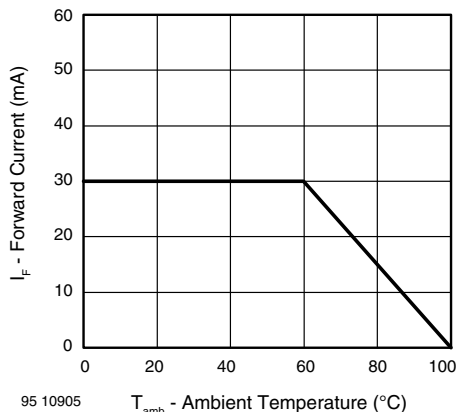
**TYPICAL CHARACTERISTICS** ( $T_{amb} = 25\text{ }^{\circ}\text{C}$ , unless otherwise specified)


Figure 1. Forward Current vs. Ambient Temperature

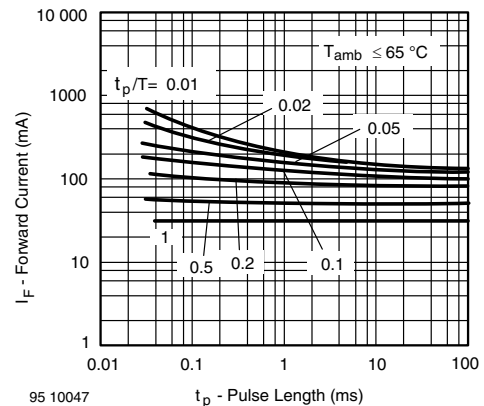


Figure 2. Forward Current vs. Pulse Length

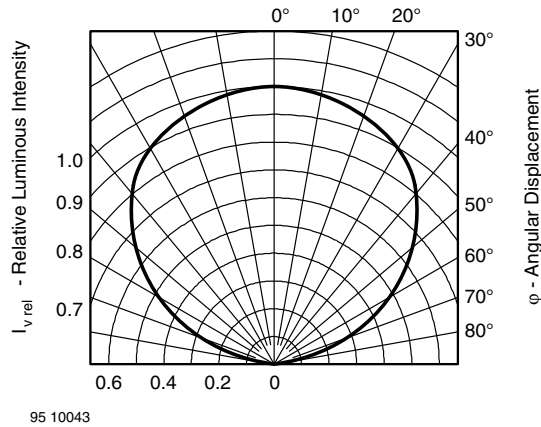


Figure 3. Rel. Luminous Intensity vs. Angular Displacement

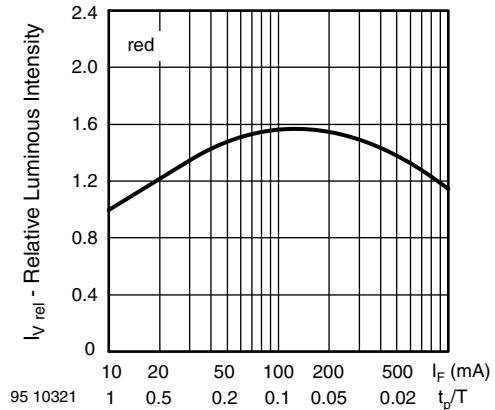


Figure 6. Rel. Lumin. Intensity vs. Forw. Current/Duty Cycle

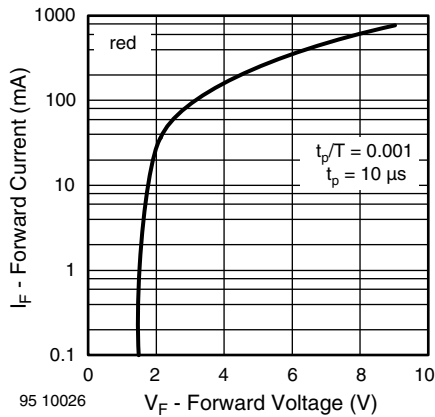


Figure 4. Forward Current vs. Forward Voltage

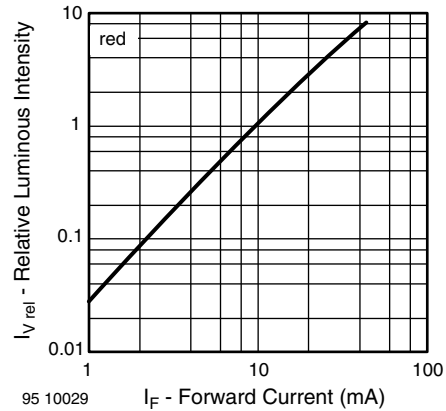


Figure 7. Relative Luminous Intensity vs. Forward Current

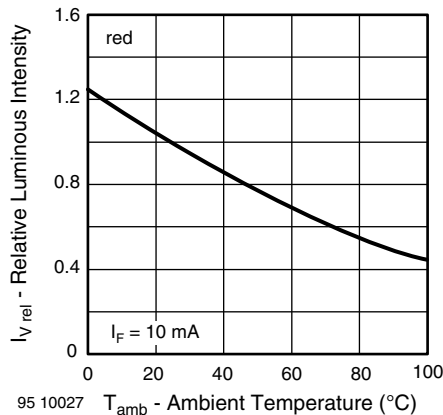


Figure 5. Rel. Luminous Intensity vs. Ambient Temperature

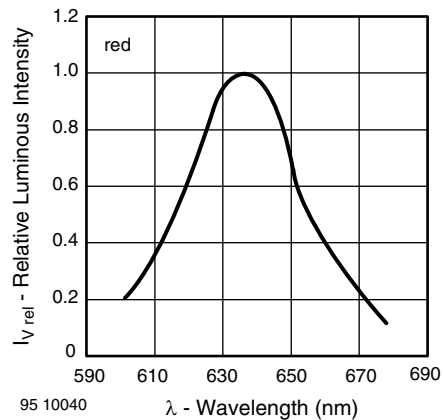


Figure 8. Relative Intensity vs. Wavelength

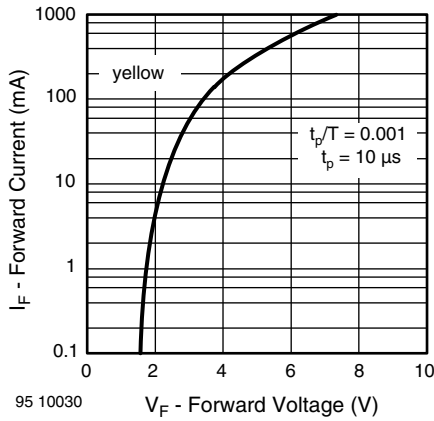


Figure 9. Forward Current vs. Forward Voltage

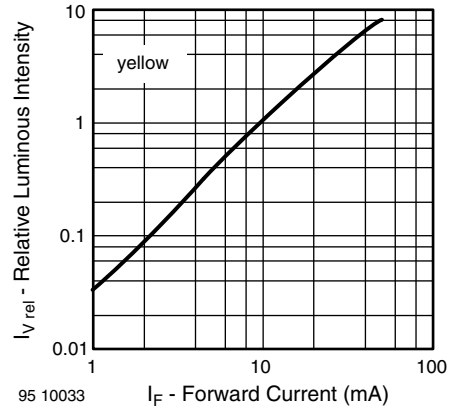


Figure 12. Relative Luminous Intensity vs. Forward Current

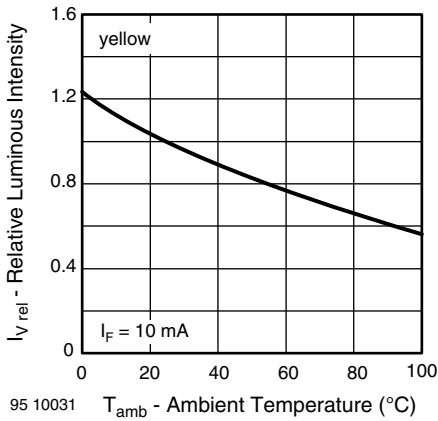


Figure 10. Rel. Luminous Intensity vs. Ambient Temperature

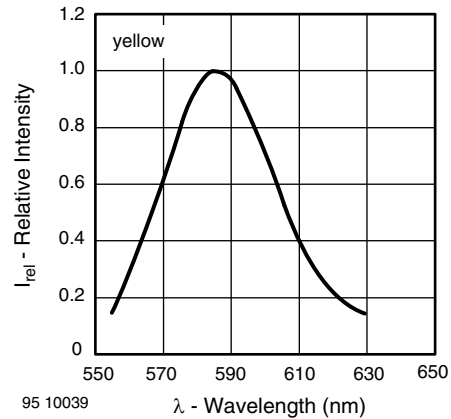


Figure 13. Relative Intensity vs. Wavelength

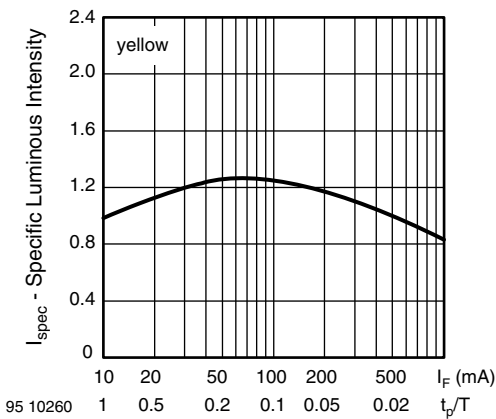


Figure 11. Rel. Lumin. Intensity vs. Forw. Current/Duty Cycle

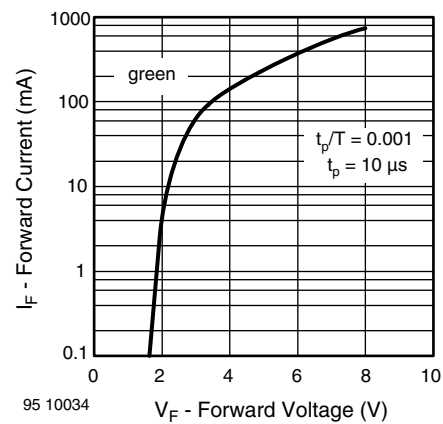


Figure 14. Forward Current vs. Forward Voltage

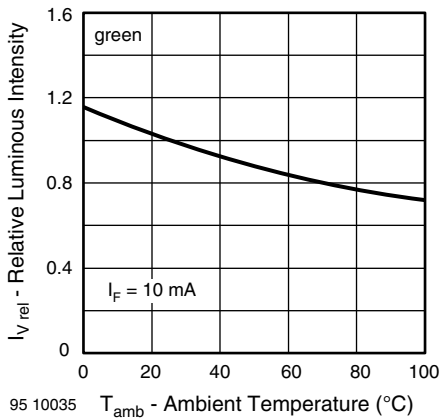


Figure 15. Rel. Luminous Intensity vs. Ambient Temperature

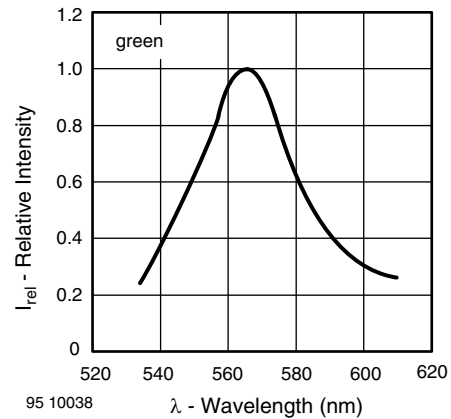


Figure 18. Relative Intensity vs. Wavelength

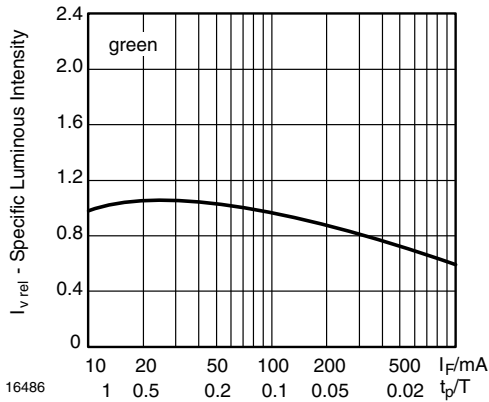


Figure 16. Rel. Lumin. Intensity vs. Forw. Current/Duty Cycle

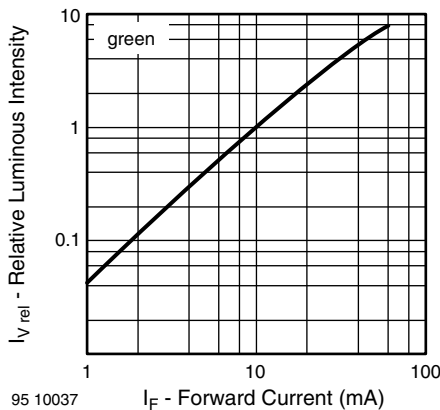
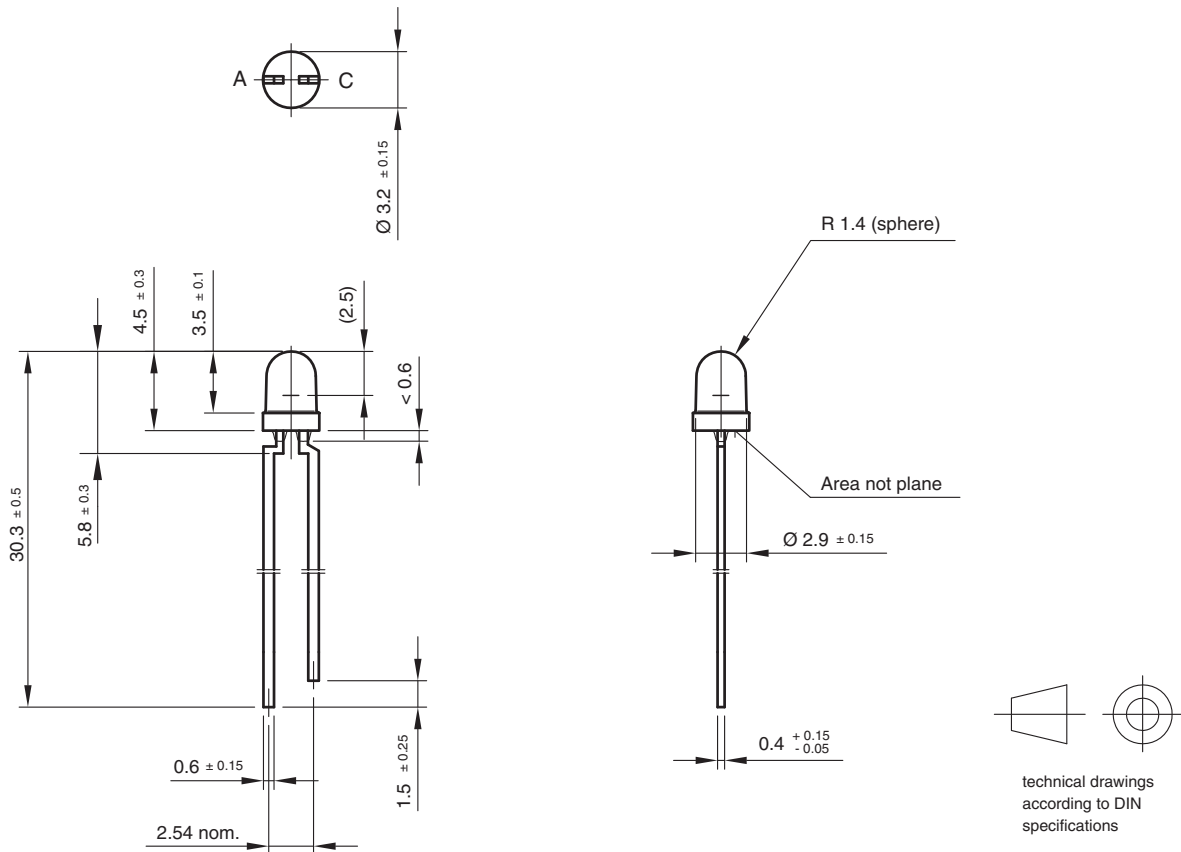


Figure 17. Relative Luminous Intensity vs. Forward Current

**PACKAGE DIMENSIONS** in millimeters



Drawing-No.: 6.544-5255.01-4  
Issue: 7; 25.09.08  
95 10913

## TAPE

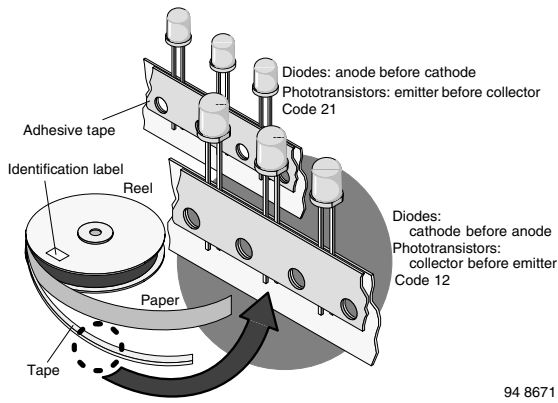


Figure 19. LED in Tape

94 8671

## AMMOPACK

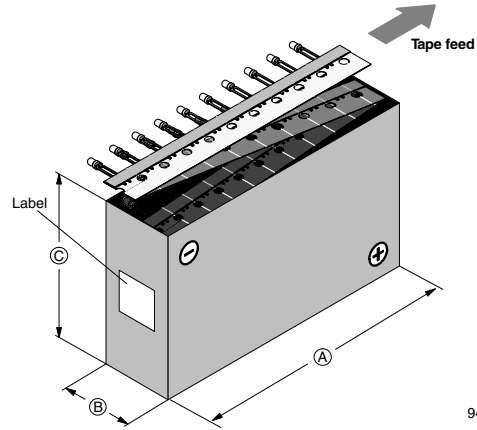
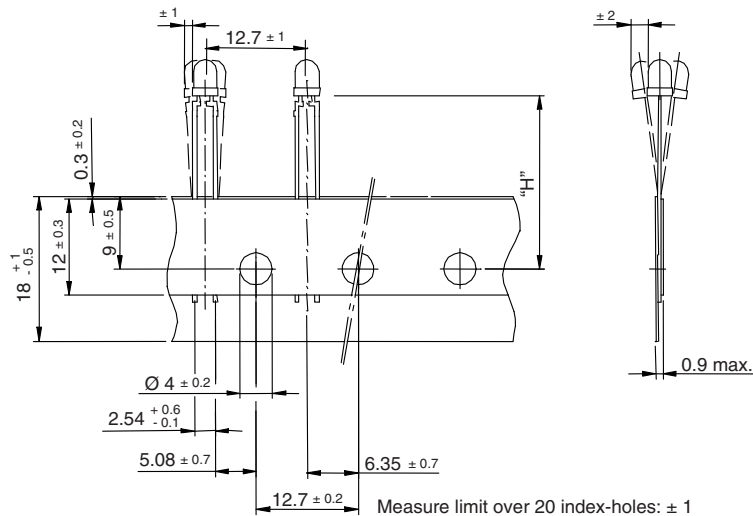


Figure 20. Tape Direction

94 8667-1

Note:  
AS12Z and AS21Z still valid for already existing types BUT NOT FOR NEW DESIGN

## TAPE DIMENSIONS in millimeters



Quantity per:	Reel (Mat. - No. 1764)
	2000

94 8171

Option	Dim. "H" ± 0.5 mm
AS	17.3
MS	25.5
CS	22.0





## Disclaimer

ALL PRODUCT, PRODUCT SPECIFICATIONS AND DATA ARE SUBJECT TO CHANGE WITHOUT NOTICE TO IMPROVE RELIABILITY, FUNCTION OR DESIGN OR OTHERWISE.

Vishay Intertechnology, Inc., its affiliates, agents, and employees, and all persons acting on its or their behalf (collectively, "Vishay"), disclaim any and all liability for any errors, inaccuracies or incompleteness contained in any datasheet or in any other disclosure relating to any product.

Vishay makes no warranty, representation or guarantee regarding the suitability of the products for any particular purpose or the continuing production of any product. To the maximum extent permitted by applicable law, Vishay disclaims (i) any and all liability arising out of the application or use of any product, (ii) any and all liability, including without limitation special, consequential or incidental damages, and (iii) any and all implied warranties, including warranties of fitness for particular purpose, non-infringement and merchantability.

Statements regarding the suitability of products for certain types of applications are based on Vishay's knowledge of typical requirements that are often placed on Vishay products in generic applications. Such statements are not binding statements about the suitability of products for a particular application. It is the customer's responsibility to validate that a particular product with the properties described in the product specification is suitable for use in a particular application. Parameters provided in datasheets and/or specifications may vary in different applications and performance may vary over time. All operating parameters, including typical parameters, must be validated for each customer application by the customer's technical experts. Product specifications do not expand or otherwise modify Vishay's terms and conditions of purchase, including but not limited to the warranty expressed therein.

Except as expressly indicated in writing, Vishay products are not designed for use in medical, life-saving, or life-sustaining applications or for any other application in which the failure of the Vishay product could result in personal injury or death. Customers using or selling Vishay products not expressly indicated for use in such applications do so at their own risk. Please contact authorized Vishay personnel to obtain written terms and conditions regarding products designed for such applications.

No license, express or implied, by estoppel or otherwise, to any intellectual property rights is granted by this document or by any conduct of Vishay. Product names and markings noted herein may be trademarks of their respective owners.

## Material Category Policy

**Vishay Intertechnology, Inc. hereby certifies that all its products that are identified as RoHS-Compliant fulfill the definitions and restrictions defined under Directive 2011/65/EU of The European Parliament and of the Council of June 8, 2011 on the restriction of the use of certain hazardous substances in electrical and electronic equipment (EEE) - recast, unless otherwise specified as non-compliant.**

**Please note that some Vishay documentation may still make reference to RoHS Directive 2002/95/EC. We confirm that all the products identified as being compliant to Directive 2002/95/EC conform to Directive 2011/65/EU.**

**Vishay Intertechnology, Inc. hereby certifies that all its products that are identified as Halogen-Free follow Halogen-Free requirements as per JEDEC JS709A standards. Please note that some Vishay documentation may still make reference to the IEC 61249-2-21 definition. We confirm that all the products identified as being compliant to IEC 61249-2-21 conform to JEDEC JS709A standards.**

Компания «Океан Электроники» предлагает заключение долгосрочных отношений при поставках импортных электронных компонентов на взаимовыгодных условиях!

Наши преимущества:

- Поставка оригинальных импортных электронных компонентов напрямую с производств Америки, Европы и Азии, а так же с крупнейших складов мира;
- Широкая линейка поставок активных и пассивных импортных электронных компонентов (более 30 млн. наименований);
- Поставка сложных, дефицитных, либо снятых с производства позиций;
- Оперативные сроки поставки под заказ (от 5 рабочих дней);
- Экспресс доставка в любую точку России;
- Помощь Конструкторского Отдела и консультации квалифицированных инженеров;
- Техническая поддержка проекта, помощь в подборе аналогов, поставка прототипов;
- Поставка электронных компонентов под контролем ВП;
- Система менеджмента качества сертифицирована по Международному стандарту ISO 9001;
- При необходимости вся продукция военного и аэрокосмического назначения проходит испытания и сертификацию в лаборатории (по согласованию с заказчиком);
- Поставка специализированных компонентов военного и аэрокосмического уровня качества (Xilinx, Altera, Analog Devices, Intersil, Interpoint, Microsemi, Actel, Aeroflex, Peregrine, VPT, Syfer, Eurofarad, Texas Instruments, MS Kennedy, Miteq, Cobham, E2V, MA-COM, Hittite, Mini-Circuits, General Dynamics и др.);

Компания «Океан Электроники» является официальным дистрибьютором и эксклюзивным представителем в России одного из крупнейших производителей разъемов военного и аэрокосмического назначения «JONHON», а так же официальным дистрибьютором и эксклюзивным представителем в России производителя высокотехнологичных и надежных решений для передачи СВЧ сигналов «FORSTAR».



## JONHON

«JONHON» (основан в 1970 г.)

Разъемы специального, военного и аэрокосмического назначения:

(Применяются в военной, авиационной, аэрокосмической, морской, железнодорожной, горно- и нефтедобывающей отраслях промышленности)

«FORSTAR» (основан в 1998 г.)

ВЧ соединители, коаксиальные кабели, кабельные сборки и микроволновые компоненты:

(Применяются в телекоммуникациях гражданского и специального назначения, в средствах связи, РЛС, а так же военной, авиационной и аэрокосмической отраслях промышленности).



Телефон: 8 (812) 309-75-97 (многоканальный)

Факс: 8 (812) 320-03-32

Электронная почта: [ocean@oceanchips.ru](mailto:ocean@oceanchips.ru)

Web: <http://oceanchips.ru/>

Адрес: 198099, г. Санкт-Петербург, ул. Калинина, д. 2, корп. 4, лит. А