



1GHz, Low-Power, SOT23, Current-Feedback Amplifiers with Shutdown

MAX4223-MAX4228

General Description

The MAX4223–MAX4228 current-feedback amplifiers combine ultra-high-speed performance, low distortion, and excellent video specifications with low-power operation. The MAX4223/MAX4224/MAX4226/MAX4228 have a shutdown feature that reduces power-supply current to 350 μ A and places the outputs into a high-impedance state. These devices operate with dual supplies ranging from ± 2.85 V to ± 5.5 V and provide a typical output drive current of 80mA. The MAX4223/MAX4225/MAX4226 are optimized for a closed-loop gain of +1 (0dB) or more and have a -3dB bandwidth of 1GHz, while the MAX4224/MAX4227/MAX4228 are compensated for a closed-loop gain of +2 (6dB) or more, and have a -3dB bandwidth of 600MHz (1.2GHz gain-bandwidth product).

The MAX4223–MAX4228 are ideal for professional video applications, with differential gain and phase errors of 0.01% and 0.02°, 0.1dB gain flatness of 300MHz, and a 1100V/ μ s slew rate. Total harmonic distortion (THD) of -60dBc (10MHz) and an 8ns settling time to 0.1% suit these devices for driving high-speed analog-to-digital inputs or for data-communications applications. The low-power shutdown mode on the MAX4223/MAX4224/MAX4226/MAX4228 makes them suitable for portable and battery-powered applications. Their high output impedance in shutdown mode is excellent for multiplexing applications.

The single MAX4223/MAX4224 are available in space-saving 6-pin SOT23 packages. All devices are available in the extended -40°C to +85°C temperature range.

Applications

ADC Input Buffers	Data Communications
Video Cameras	Video Line Drivers
Video Switches	Video Multiplexing
Video Editors	XDSL Drivers
RF Receivers	Differential Line Drivers

Pin Configurations

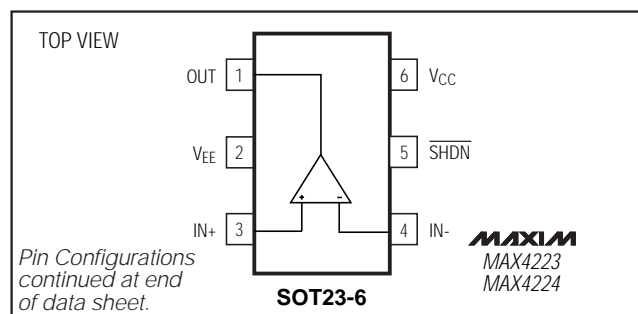

Features

- ♦ **Ultra-High Speed and Fast Settling Time:**
 - 1GHz -3dB Bandwidth (MAX4223, Gain = +1)
 - 600MHz -3dB Bandwidth (MAX4224, Gain = +2)
 - 1700V/ μ s Slew Rate (MAX4224)
 - 5ns Settling Time to 0.1% (MAX4224)
- ♦ **Excellent Video Specifications (MAX4223):**
 - Gain Flatness of 0.1dB to 300MHz
 - 0.01%/0.02° DG/DP Errors
- ♦ **Low Distortion:**
 - 60dBc THD ($f_c = 10$ MHz)
 - 42dBm Third-Order Intercept ($f = 30$ MHz)
- ♦ **6.0mA Quiescent Supply Current (per amplifier)**
- ♦ **Shutdown Mode:**
 - 350 μ A Supply Current (per amplifier)
 - 100k Ω Output Impedance
- ♦ **High Output Drive Capability:**
 - 80mA Output Current
 - Drives up to 4 Back-Terminated 75 Ω Loads to ± 2.5 V while Maintaining Excellent Differential Gain/Phase Characteristics
- ♦ **Available in Tiny 6-Pin SOT23 and 10-Pin μ MAX Packages**

Ordering Information

PART	TEMP. RANGE	PIN-PACKAGE	SOT TOP MARK
MAX4223EUT-T	-40°C to +85°C	6 SOT23	AAAD
MAX4223ESA	-40°C to +85°C	8 SO	—

Ordering Information continued at end of data sheet.

Selector Guide

PART	MIN. GAIN	AMPS PER PKG.	SHUT-DOWN MODE	PIN-PACKAGE
MAX4223	1	1	Yes	6 SOT23, 8 SO
MAX4224	2	1	Yes	6 SOT23, 8 SO
MAX4225	1	2	No	8 SO
MAX4226	1	2	Yes	10 μ MAX, 14 SO
MAX4227	2	2	No	8 SO
MAX4228	2	2	Yes	10 μ MAX, 14 SO

1GHz, Low-Power, SOT23, Current-Feedback Amplifiers with Shutdown

ABSOLUTE MAXIMUM RATINGS

Supply Voltage (V_{CC} to V_{EE})	12V	Continuous Power Dissipation ($T_A = +70^\circ\text{C}$)	
Analog Input Voltage	($V_{EE} - 0.3\text{V}$) to ($V_{CC} + 0.3\text{V}$)	6-Pin SOT23 (derate 7.1mW/ $^\circ\text{C}$ above $+70^\circ\text{C}$)	571mW
Analog Input Current	$\pm 25\text{mA}$	8-Pin SO (derate 5.9mW/ $^\circ\text{C}$ above $+70^\circ\text{C}$)	471mW
$\overline{\text{SHDN}}$ Input Voltage	($V_{EE} - 0.3\text{V}$) to ($V_{CC} + 0.3\text{V}$)	10-Pin μMAX (derate 5.6mW/ $^\circ\text{C}$ above $+70^\circ\text{C}$)	444mW
Short-Circuit Duration		14-Pin SO (derate 8.3mW/ $^\circ\text{C}$ above $+70^\circ\text{C}$)	667mW
OUT to GND	Continuous	Operating Temperature Range	-40°C to $+85^\circ\text{C}$
OUT to V_{CC} or V_{EE}	5sec	Storage Temperature Range	-65°C to $+150^\circ\text{C}$
		Lead Temperature (soldering, 10sec)	$+300^\circ\text{C}$

Stresses beyond those listed under "Absolute Maximum Ratings" may cause permanent damage to the device. These are stress ratings only, and functional operation of the device at these or any other conditions beyond those indicated in the operational sections of the specifications is not implied. Exposure to absolute maximum rating conditions for extended periods may affect device reliability.

DC ELECTRICAL CHARACTERISTICS

($V_{CC} = +5\text{V}$, $V_{EE} = -5\text{V}$, $\overline{\text{SHDN}} = 5\text{V}$, $V_{CM} = 0\text{V}$, $R_L = \infty$, $T_A = T_{MIN}$ to T_{MAX} , unless otherwise noted. Typical values are at $T_A = +25^\circ\text{C}$.) (Note 1)

PARAMETER	SYMBOL	CONDITIONS		MIN	TYP	MAX	UNITS	
Input Offset Voltage	V_{OS}	$T_A = +25^\circ\text{C}$	MAX4223/MAX4224		± 0.5	± 4	mV	
			MAX4225-MAX4228		± 0.5	± 5		
		$T_A = T_{MIN}$ to T_{MAX}	MAX4223/MAX4224					± 6
			MAX4225-MAX4228					± 7
Input Offset Voltage Drift	TCV_{OS}				± 2	$\mu\text{V}/^\circ\text{C}$		
Input Bias Current (Positive Input)	I_{B+}	$T_A = +25^\circ\text{C}$			± 2	± 10	μA	
		$T_A = T_{MIN}$ to T_{MAX}						± 15
Input Bias Current (Negative Input)	I_{B-}	$T_A = +25^\circ\text{C}$	MAX4223/MAX4224		± 4	± 20	μA	
			MAX4225-MAX4228		± 4	± 25		
		$T_A = T_{MIN}$ to T_{MAX}	MAX4223/MAX4224					± 30
			MAX4225-MAX4228					± 35
Input Resistance (Positive Input)	R_{IN+}				700	k Ω		
Input Resistance (Negative Input)	R_{IN-}				45	Ω		
Input Common-Mode Voltage Range	V_{CM}	Inferred from CMRR test		± 2.5	± 3.2	V		
Common-Mode Rejection Ratio	CMRR	$V_{CM} = \pm 2.5\text{V}$	$T_A = +25^\circ\text{C}$		55	61	dB	
			$T_A = T_{MIN}$ to T_{MAX}			50		
Operating Supply Voltage Range	V_{CC}/V_{EE}	Inferred from PSRR test		± 2.85		± 5.5	V	
Power-Supply Rejection Ratio	PSRR	$V_{CC} = 2.85\text{V}$ to 5.5V , $V_{EE} = -2.85\text{V}$ to -5.5V	$T_A = +25^\circ\text{C}$		68	74	dB	
			$T_A = T_{MIN}$ to T_{MAX}			63		
Quiescent Supply Current (per Amplifier)	I_{SY}	Normal mode ($\overline{\text{SHDN}} = 5\text{V}$)			6.0	9.0	mA	
		Shutdown mode ($\overline{\text{SHDN}} = 0\text{V}$)			0.35	0.55		
Open-Loop Transresistance	T_R	$V_{OUT} = \pm 2.5\text{V}$	$R_L = \infty$		0.7	1.5	M Ω	
			$R_L = 50\Omega$		0.3	0.8		
Output Voltage Swing	V_{OUT}	$R_L = 50\Omega$		± 2.5	± 2.8	V		
Output Current (Note 2)	I_{OUT}	$V_{OUT} = \pm 2.5\text{V}$		60	80	mA		
Short-Circuit Output Current	I_{SC}	$R_L = \text{short to ground}$			140	mA		
$\overline{\text{SHDN}}$ Logic Low	V_{IL}					0.8	V	
$\overline{\text{SHDN}}$ Logic High	V_{IH}			2.0			V	

1GHz, Low-Power, SOT23, Current-Feedback Amplifiers with Shutdown

MAX4223-MAX4228

DC ELECTRICAL CHARACTERISTICS (continued)

($V_{CC} = +5V$, $V_{EE} = -5V$, $\overline{SHDN} = 5V$, $V_{CM} = 0V$, $R_L = \infty$, $T_A = T_{MIN}$ to T_{MAX} , unless otherwise noted. Typical values are at $T_A = +25^\circ C$.) (Note 1)

PARAMETER	SYMBOL	CONDITIONS	MIN	TYP	MAX	UNITS
\overline{SHDN} Input Current	I_{IL}/I_{IH}	$\overline{SHDN} = 0V$ or $5V$		25	70	μA
Shutdown Mode Output Impedance		$\overline{SHDN} = 0V$, $V_{OUT} = -2.5V$ to $+2.5V$ (Note 3)	10	100		$k\Omega$

AC ELECTRICAL CHARACTERISTICS

($V_{CC} = +5V$, $V_{EE} = -5V$, $\overline{SHDN} = 5V$, $V_{CM} = 0V$, $A_v = +1V/V$ for MAX4223/MAX4225/MAX4226, $A_v = +2V/V$ for MAX4224/MAX4227/MAX4228, $R_L = 100\Omega$, $T_A = +25^\circ C$, unless otherwise noted.) (Note 4)

PARAMETER	SYMBOL	CONDITIONS		MIN	TYP	MAX	UNITS
-3dB Small-Signal Bandwidth (Note 5)	BW	$V_{OUT} = 20mVp-p$	MAX4223/5/6	750	1000		MHz
			MAX4224/7/8	325	600		
Bandwidth for $\pm 0.1dB$ Gain Flatness (Note 5)	$BW_{0.1dB}$	$V_{OUT} = 20mVp-p$	MAX4223/5/6	100	300		MHz
			MAX4224/7/8	60	200		
Gain Peaking			MAX4223/5/6	1.5			dB
			MAX4224/7/8	0.1			
Large-Signal Bandwidth	BW_{LS}	$V_{OUT} = 2Vp-p$	MAX4223/5/6	250			MHz
			MAX4224/7/8	330			
Slew Rate (Note 5)	SR	$V_{OUT} = 4V$ step	Rising edge	MAX4223/5/6	850	1100	$V/\mu s$
				MAX4224/7/8	1400	1700	
			Falling edge	MAX4223/5/6	625	800	
				MAX4224/7/8	1100	1400	
Settling Time to 0.1%	t_s	$V_{OUT} = 2V$ step	MAX4223/5/6	8			ns
			MAX4224/7/8	5			
Rise and Fall Time	t_r, t_f	$V_{OUT} = 2V$ step	MAX4223/5/6	1.5			ns
			MAX4224/7/8	1.0			
Off Isolation		$\overline{SHDN} = 0V$, $f = 10MHz$, MAX4223/4/6/8		65			dB
Crosstalk	X_{TALK}	$f = 30MHz$, $R_s = 50\Omega$	MAX4225/6	-68			dB
			MAX4227/8	-72			
Turn-On Time from Shutdown	t_{ON}	MAX4223/4/6/8		2			μs
Turn-Off Time to Shutdown	t_{OFF}	MAX4223/4/6/8		300			ns
Power-Up Time	t_{UP}	$V_{CC}, V_{EE} = 0V$ to $\pm 5V$ step		100			ns
Differential Gain Error	DG	$R_L = 150\Omega$ (Note 6)	MAX4223/5/6	0.01			%
			MAX4224/7/8	0.02			
Differential Phase Error	DP	$R_L = 150\Omega$ (Note 6)	MAX4223/5/6	0.02			degrees
			MAX4224/7/8	0.01			
Total Harmonic Distortion	THD	$V_{OUT} = 2Vp-p$, $f_c = 10MHz$	$R_L = 100\Omega$	MAX4223/5/6	-60		dBc
				MAX4224/7/8	-61		
			$R_L = 1k\Omega$	MAX4223/5/6	-65		
				MAX4224/7/8	-78		

1GHz, Low-Power, SOT23, Current-Feedback Amplifiers with Shutdown

AC ELECTRICAL CHARACTERISTICS (continued)

($V_{CC} = +5V$, $V_{EE} = -5V$, $\overline{SHDN} = 5V$, $V_{CM} = 0V$, $A_V = +1V/V$ for MAX4223/MAX4225/MAX4226, $A_V = +2V/V$ for MAX4224/MAX4227/MAX4228, $R_L = 100\Omega$, $T_A = +25^\circ C$, unless otherwise noted.) (Note 4)

PARAMETER	SYMBOL	CONDITIONS	MIN	TYP	MAX	UNITS
Output Impedance	Z_{OUT}	$f = 10kHz$		2		Ω
Third-Order Intercept	IP3	$f = 30kHz$	MAX4223/5/6	42		dBm
		$f_Z = 30.1MHz$	MAX4224/7/8	36		
Spurious-Free Dynamic Range	SFDR	$f = 10kHz$	MAX4223/5/6	-61		dB
			MAX4224/7/8	-62		
1dB Gain Compression		$f = 10kHz$		20		dBm
Input Noise Voltage Density	e_n	$f = 10kHz$		2		nV/\sqrt{Hz}
Input Noise Current Density	i_{n+}, i_{n-}	$f = 10kHz$	IN+	3		pA/\sqrt{Hz}
			IN-	20		
Input Capacitance (Note 7)	C_{IN}	SO-8, SO-14 packages	Pin to pin	0.3		pF
			Pin to GND	1.0		
		SOT23-6, 10-pin μ MAX packages	Pin to pin	0.3		
			Pin to GND	0.8		

- Note 1:** The MAX422_EUT is 100% production tested at $T_A = +25^\circ C$. Specifications over temperature limits are guaranteed by design.
- Note 2:** Absolute Maximum Power Dissipation must be observed.
- Note 3:** Does not include impedance of external feedback resistor network.
- Note 4:** AC specifications shown are with optimal values of R_F and R_G . These values vary for product and package type, and are tabulated in the *Applications Information* section of this data sheet.
- Note 5:** The AC specifications shown are not measured in a production test environment. The minimum AC specifications given are based on the combination of worst-case design simulations along with a sample characterization of units. These minimum specifications are for design guidance only and are not intended to guarantee AC performance (see *AC Testing/Performance*). For 100% testing of these parameters, contact the factory.
- Note 6:** Input Test Signal: 3.58MHz sine wave of amplitude 40IRE superimposed on a linear ramp (0IRE to 100IRE). IRE is a unit of video signal amplitude developed by the International Radio Engineers. 140IRE = 1V.
- Note 7:** Assumes printed circuit board layout similar to that of Maxim's evaluation kit.

Typical Operating Characteristics

($V_{CC} = +5V$, $V_{EE} = -5V$, $R_L = 100\Omega$, $T_A = +25^\circ C$, unless otherwise noted.)

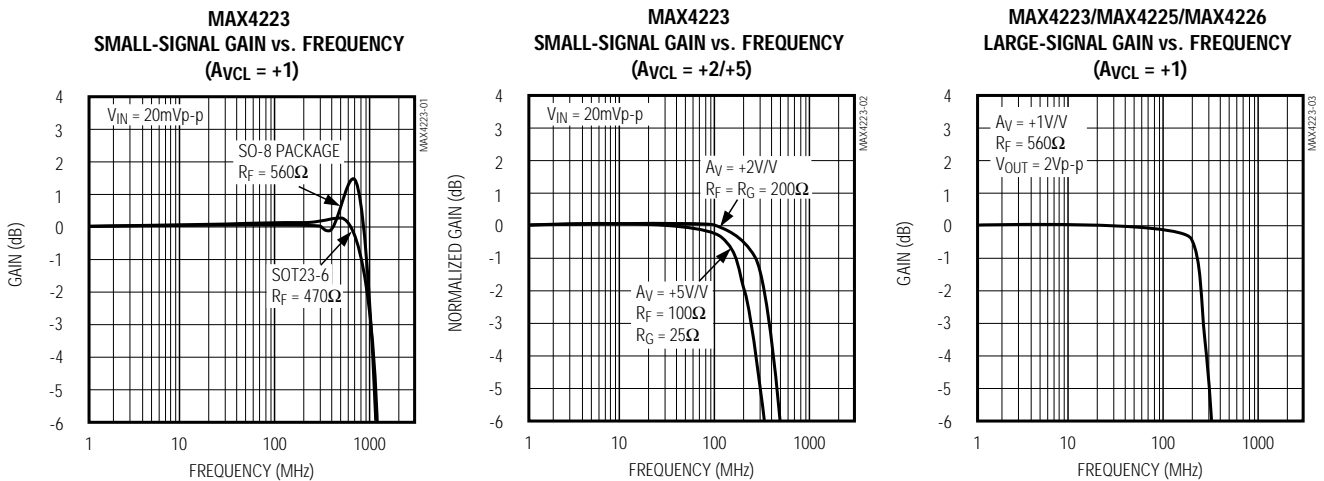

1GHz, Low-Power, SOT23, Current-Feedback Amplifiers with Shutdown

Typical Operating Characteristics (continued)

($V_{CC} = +5V$, $V_{EE} = -5V$, $R_L = 100\Omega$, $T_A = +25^\circ C$, unless otherwise noted.)

MAX4223-MAX4228

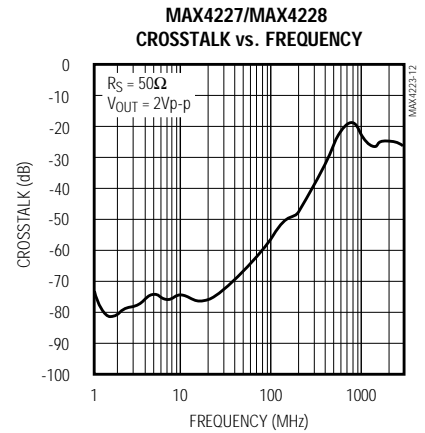
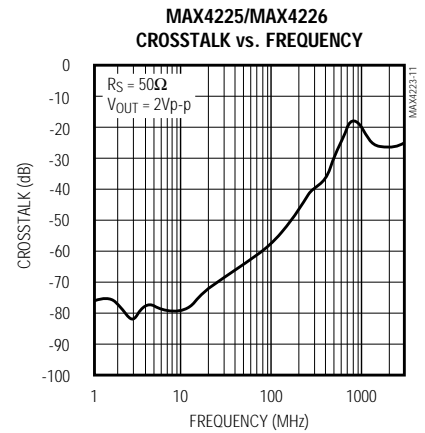
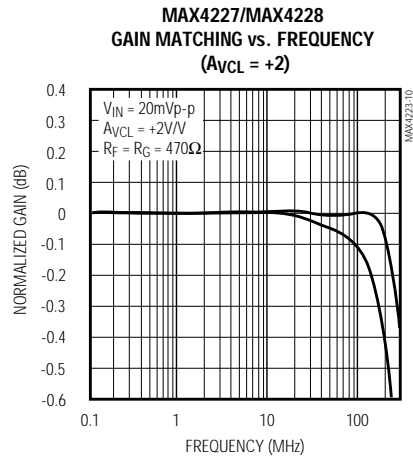
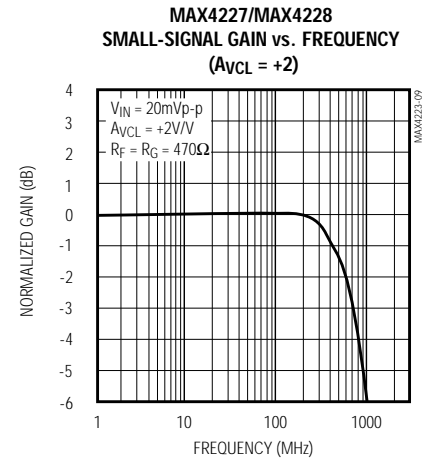
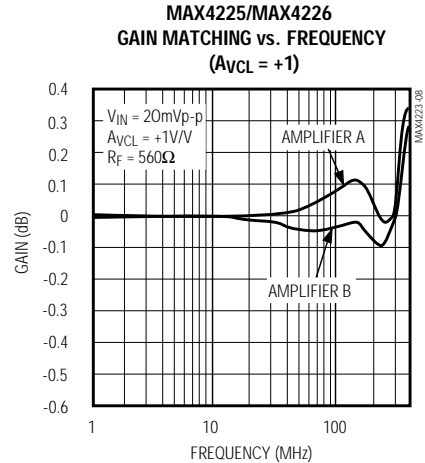
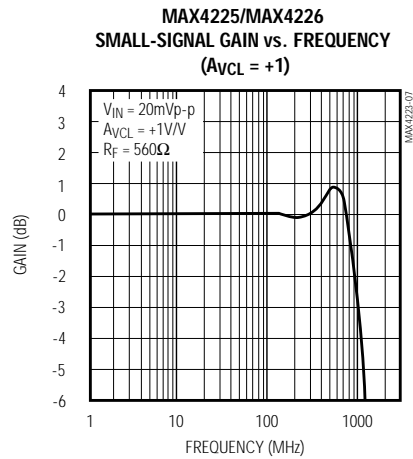
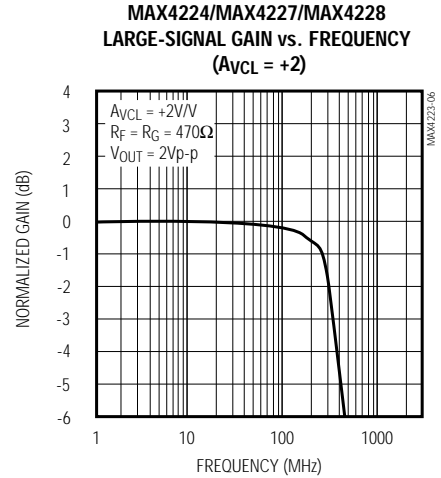
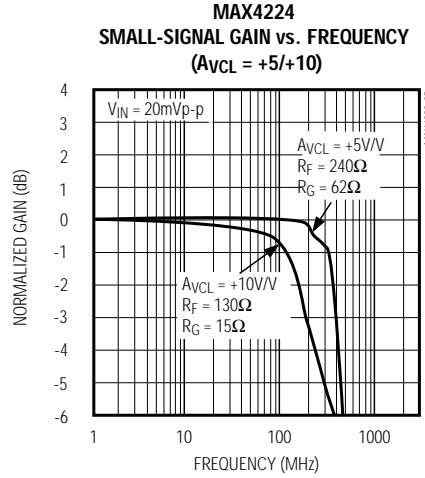
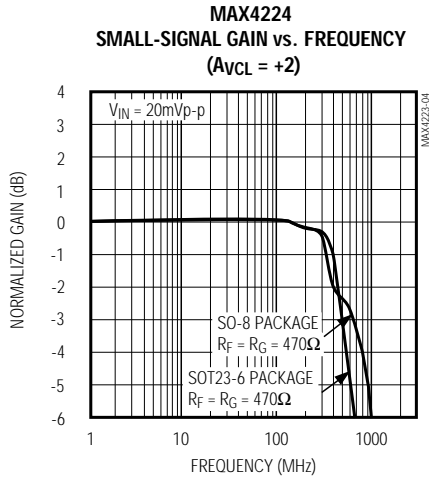

1GHz, Low-Power, SOT23, Current-Feedback Amplifiers with Shutdown

Typical Operating Characteristics (continued)

($V_{CC} = +5V$, $V_{EE} = -5V$, $R_L = 100\Omega$, $T_A = +25^\circ C$, unless otherwise noted.)

**MAX4223/MAX4225/MAX4226
POWER-SUPPLY REJECTION RATIO
vs. FREQUENCY ($A_{VCL} = +1$)**

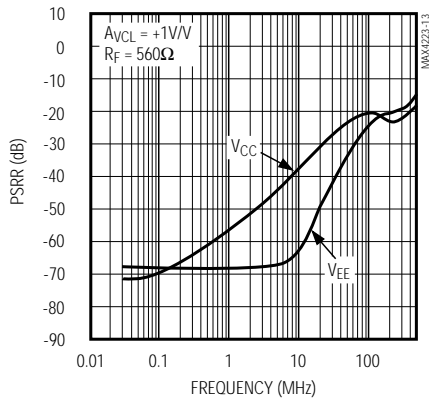

**MAX4224/MAX4227/MAX4228
POWER-SUPPLY REJECTION RATIO
vs. FREQUENCY ($A_{VCL} = +2$)**

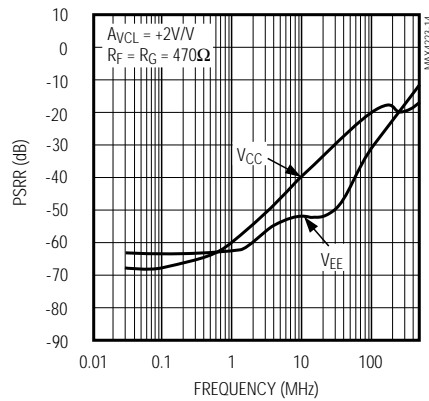

OUTPUT IMPEDANCE vs. FREQUENCY

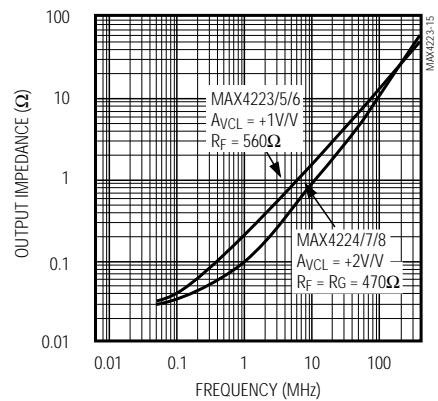

**SHUTDOWN MODE OUTPUT ISOLATION
vs. FREQUENCY**

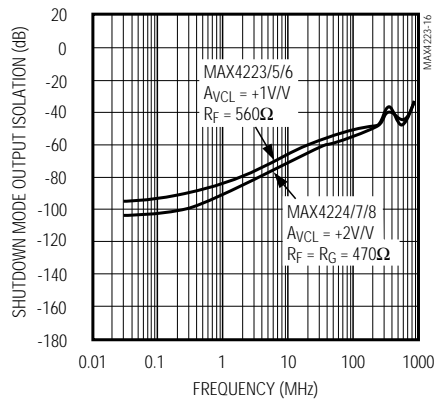

**MAX4223/MAX4225/MAX4226
TOTAL HARMONIC DISTORTION
vs. FREQUENCY ($R_L = 150\Omega$)**

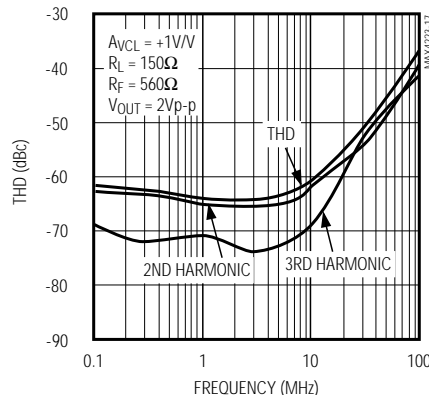

**MAX4223/MAX4225/MAX4226
TOTAL HARMONIC DISTORTION
vs. FREQUENCY ($R_L = 1k\Omega$)**

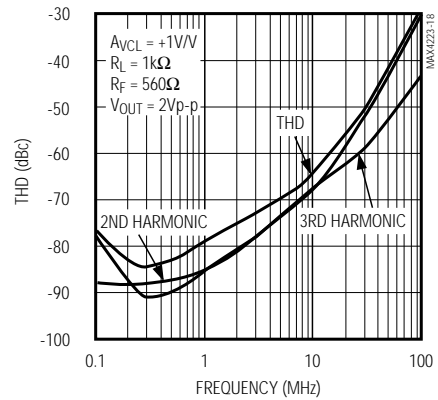

**MAX4224/MAX4227/MAX4228
TOTAL HARMONIC DISTORTION
vs. FREQUENCY ($R_L = 150\Omega$)**

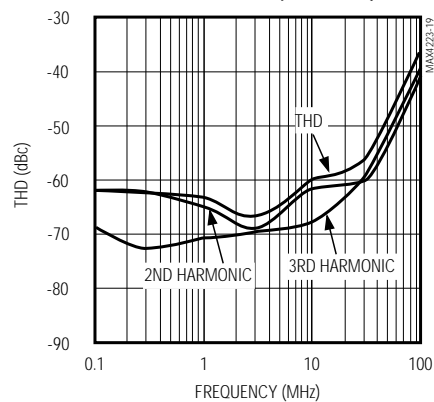

**MAX4224/MAX4227/MAX4228
TOTAL HARMONIC DISTORTION
vs. FREQUENCY ($R_L = 1k\Omega$)**

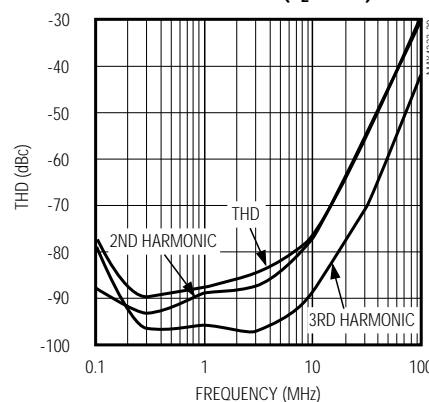

**TWO-TONE THIRD-ORDER INTERCEPT
vs. FREQUENCY**

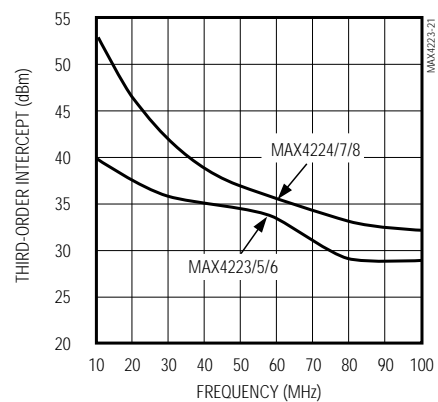

1GHz, Low-Power, SOT23, Current-Feedback Amplifiers with Shutdown

Typical Operating Characteristics (continued)

($V_{CC} = +5V$, $V_{EE} = -5V$, $R_L = 100\Omega$, $T_A = +25^\circ C$, unless otherwise noted.)

MAX4223-MAX4228

**MAX4223/MAX4225/MAX4226
SMALL-SIGNAL PULSE RESPONSE
($A_{vCL} = +1$)**

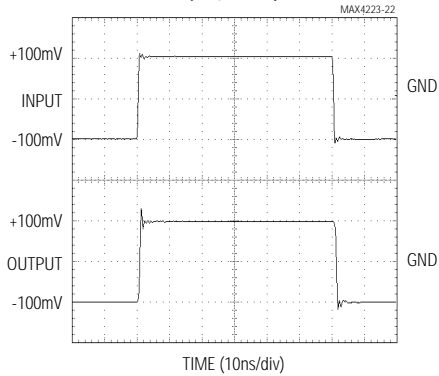

**MAX4223/MAX4225/MAX4226
SMALL-SIGNAL PULSE RESPONSE
($A_{vCL} = +1$, $C_L = 25pF$)**

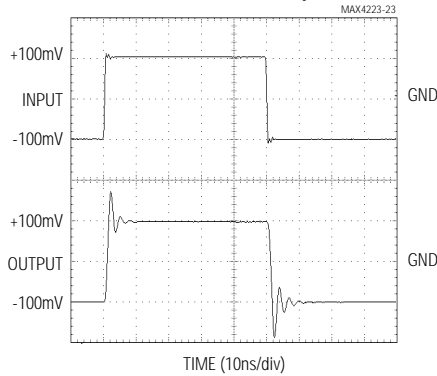

**MAX4224/MAX4227/MAX4228
SMALL-SIGNAL PULSE RESPONSE
($A_{vCL} = +2$)**

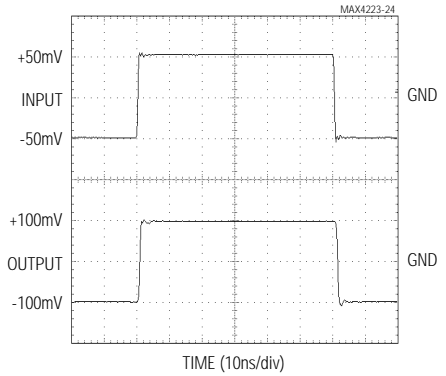

**MAX4224/MAX4227/MAX4228
SMALL-SIGNAL PULSE RESPONSE
($A_{vCL} = +2$, $C_L = 10pF$)**

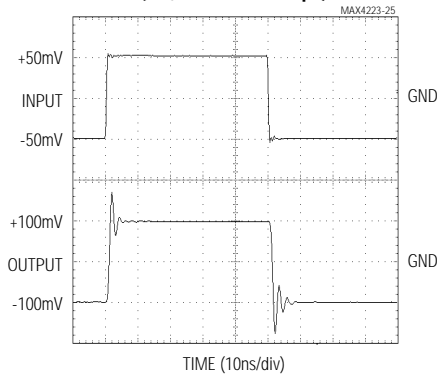

**MAX4223/MAX4225/MAX4226
LARGE-SIGNAL PULSE RESPONSE
($A_{vCL} = +1$)**

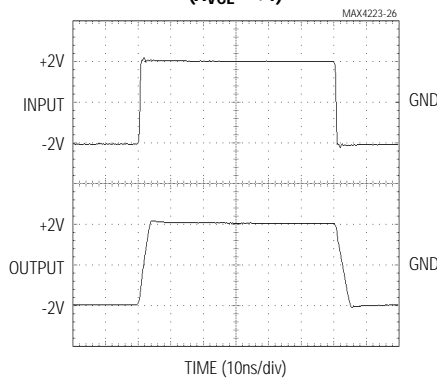

**MAX4223/MAX4225/MAX4226
LARGE-SIGNAL PULSE RESPONSE
($A_{vCL} = +1$, $C_L = 25pF$)**

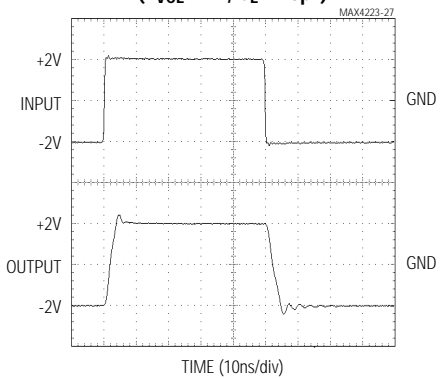

**MAX4224/MAX4227/MAX4228
LARGE-SIGNAL PULSE RESPONSE
($A_{vCL} = +2$)**

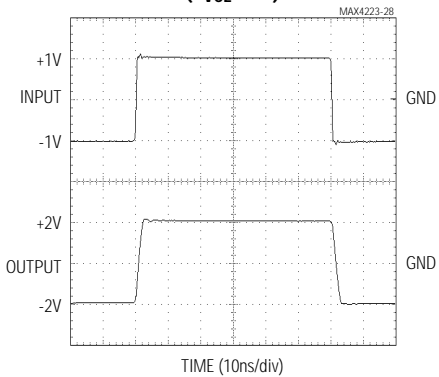

**MAX4224/MAX4227/MAX4228
LARGE-SIGNAL PULSE RESPONSE
($A_{vCL} = +2$, $C_L = 10pF$)**

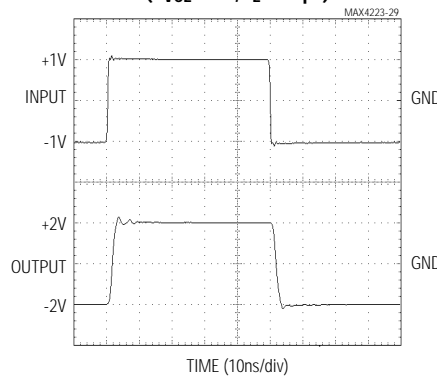

**MAX4224/MAX4227/MAX4228
LARGE-SIGNAL PULSE RESPONSE
($A_{vCL} = +5$)**

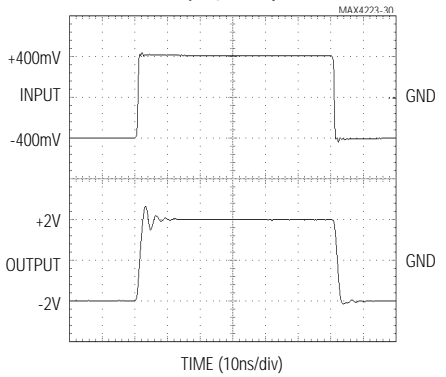

1GHz, Low-Power, SOT23, Current-Feedback Amplifiers with Shutdown

Typical Operating Characteristics (continued)

($V_{CC} = +5V$, $V_{EE} = -5V$, $R_L = 100\Omega$, $T_A = +25^\circ C$, unless otherwise noted.)

POWER-SUPPLY CURRENT PER AMPLIFIER vs. TEMPERATURE

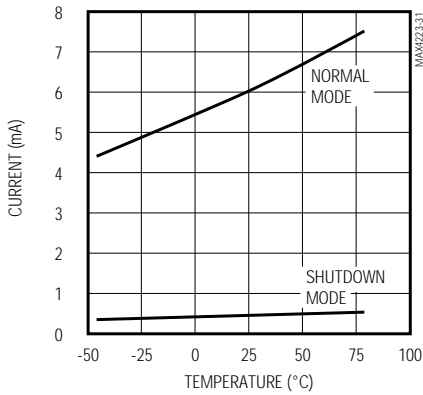

INPUT BIAS CURRENT vs. TEMPERATURE

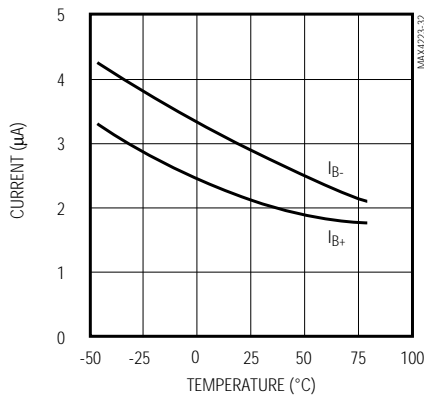

SHORT-CIRCUIT OUTPUT CURRENT vs. TEMPERATURE

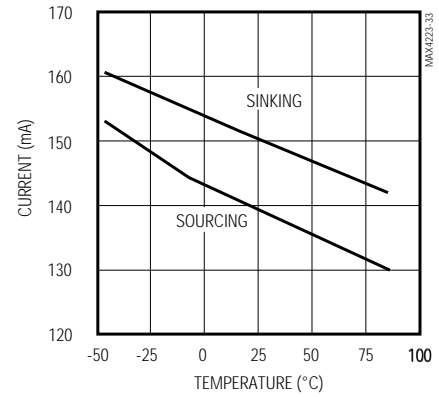

POSITIVE OUTPUT SWING vs. TEMPERATURE

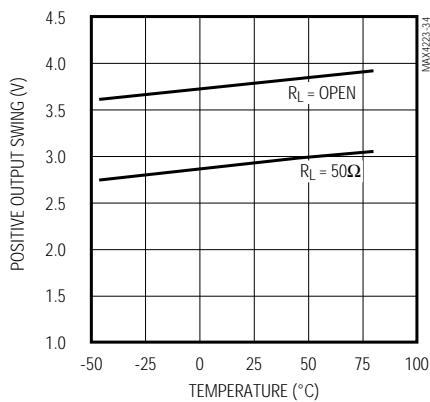

NEGATIVE OUTPUT SWING vs. TEMPERATURE

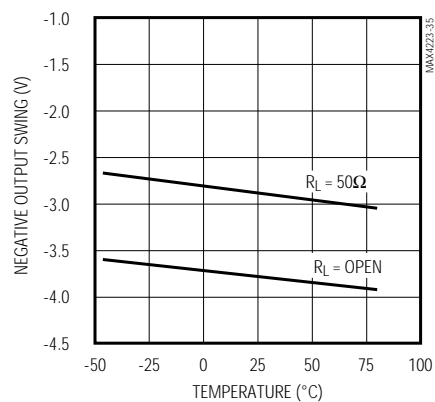

1GHz, Low-Power, SOT23, Current-Feedback Amplifiers with Shutdown

Pin Description

MAX4223-MAX4228

PIN					NAME	FUNCTION
MAX4223/MAX4224		MAX4225 MAX4227	MAX4226/MAX4228			
SOT23	SO	SO	μMAX	SO		
—	1, 5	—	—	5, 7, 8, 10	N.C.	No Connect. Not internally connected. Tie to GND for optimum AC performance.
1	6	—	—	—	OUT	Amplifier Output
2	4	4	4	4	VEE	Negative Power-Supply Voltage. Connect to -5V.
3	3	—	—	—	IN+	Amplifier Noninverting Input
4	2	—	—	—	IN-	Amplifier Inverting Input
5	8	—	—	—	$\overline{\text{SHDN}}$	Amplifier Shutdown. Connect to +5V for normal operation. Connect to GND for low-power shutdown.
6	7	8	10	14	VCC	Positive Power-Supply Voltage. Connect to +5V.
—	—	1	1	1	OUTA	Amplifier A Output
—	—	2	2	2	INA-	Amplifier A Inverting Input
—	—	3	3	3	INA+	Amplifier A Noninverting Input
—	—	5	7	11	INB+	Amplifier B Noninverting Input
—	—	6	8	12	INB-	Amplifier B Inverting Input
—	—	7	9	13	OUTB	Amplifier B Output
—	—	—	5	6	$\overline{\text{SHDNA}}$	Amplifier A Shutdown Input. Connect to +5V for normal operation. Connect to GND for low-power shutdown mode.
—	—	—	6	9	$\overline{\text{SHDNB}}$	Amplifier B Shutdown Input. Connect to +5V for normal operation. Connect to GND for low-power shutdown mode.

1GHz, Low-Power, SOT23, Current-Feedback Amplifiers with Shutdown

Detailed Description

The MAX4223–MAX4228 are ultra-high-speed, low-power, current-feedback amplifiers featuring -3dB bandwidths up to 1GHz, 0.1dB gain flatness up to 300MHz, and very low differential gain and phase errors of 0.01% and 0.02°, respectively. These devices operate on dual $\pm 5V$ or $\pm 3V$ power supplies and require only 6mA of supply current per amplifier. The MAX4223/MAX4225/MAX4226 are optimized for closed-loop gains of +1 (0dB) or more and have -3dB bandwidths of 1GHz. The MAX4224/MAX4227/MAX4228 are optimized for closed-loop gains of +2 (6dB) or more, and have -3dB bandwidths of 600MHz (1.2GHz gain-bandwidth product).

The current-mode feedback topology of these amplifiers allows them to achieve slew rates of up to 1700V/ μs with corresponding large signal bandwidths up to 330MHz. Each device in this family has an output that is capable of driving a minimum of 60mA of output current to $\pm 2.5V$.

Theory of Operation

Since the MAX4223–MAX4228 are current-feedback amplifiers, their open-loop transfer function is expressed as a transimpedance:

$$\frac{\Delta V_{OUT}}{\Delta I_{IN-}} \text{ or } T_Z$$

The frequency behavior of this open-loop transimpedance is similar to the open-loop gain of a voltage-feedback amplifier. That is, it has a large DC value and decreases at approximately 6dB per octave.

Analyzing the current-feedback amplifier in a gain configuration (Figure 1) yields the following transfer function:

$$\frac{V_{OUT}}{V_{IN}} = G \times \frac{T_Z(S)}{T_Z(S) + G \times R_{IN-} + R_F}$$

$$\text{where } G = A_V = 1 + \frac{R_F}{R_G}$$

At low gains, $(G \times R_{IN-}) \ll R_F$. Therefore, unlike traditional voltage-feedback amplifiers, the closed-loop bandwidth is essentially independent of the closed-loop gain. Note also that at low frequencies, $T_Z \gg [(G \times R_{IN-}) + R_F]$, so that:

$$\frac{V_{OUT}}{V_{IN}} = G = 1 + \frac{R_F}{R_G}$$

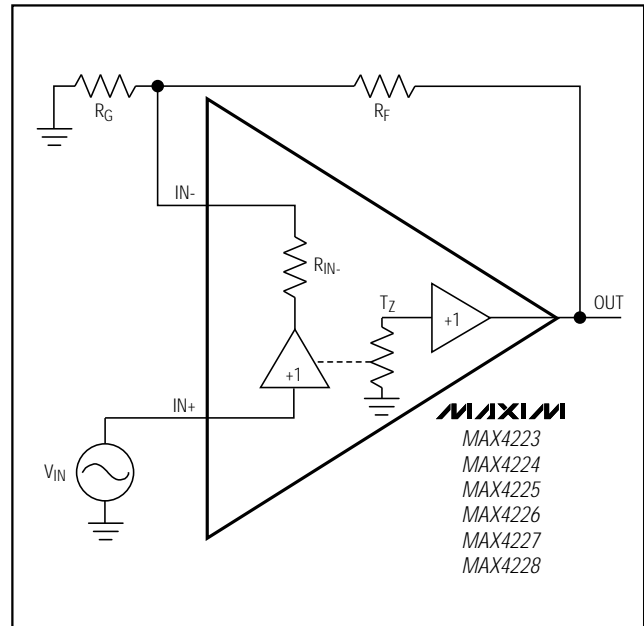

Figure 1. Current-Feedback Amplifier

Low-Power Shutdown Mode

The MAX4223/MAX4224/MAX4226/MAX4228 have a shutdown mode that is activated by driving the SHDN input low. When powered from $\pm 5V$ supplies, the SHDN input is compatible with TTL logic. Placing the amplifier in shutdown mode reduces quiescent supply current to 350 μA typical, and puts the amplifier output into a high-impedance state (100k Ω typical). This feature allows these devices to be used as multiplexers in wideband systems. To implement the mux function, the outputs of multiple amplifiers can be tied together, and only the amplifier with the selected input will be enabled. All of the other amplifiers will be placed in the low-power shutdown mode, with their high output impedance presenting very little load to the active amplifier output. For gains of +2 or greater, the feedback network impedance of all the amplifiers used in a mux application must be considered when calculating the total load on the active amplifier output.

Applications Information

Layout and Power-Supply Bypassing

The MAX4223–MAX4228 have an extremely high bandwidth, and consequently require careful board layout, including the possible use of constant-impedance microstrip or stripline techniques.

1GHz, Low-Power, SOT23, Current-Feedback Amplifiers with Shutdown

To realize the full AC performance of these high-speed amplifiers, pay careful attention to power-supply bypassing and board layout. The PC board should have at least two layers: a signal and power layer on one side and a large, low-impedance ground plane on the other. The ground plane should be as free of voids as possible, with one exception: the inverting input pin (IN-) should have as low a capacitance to ground as possible. This means that there should be no ground plane under IN- or under the components (R_F and R_G) connected to it. With multilayer boards, locate the ground plane on a layer that incorporates no signal or power traces.

Whether or not a constant-impedance board is used, it is best to observe the following guidelines when designing the board:

- 1) Do not use wire-wrapped boards (they are too inductive) or breadboards (they are too capacitive).
- 2) Do not use IC sockets. IC sockets increase reactance.
- 3) Keep signal lines as short and straight as possible. Do not make 90° turns; round all corners.
- 4) Observe high-frequency bypassing techniques to maintain the amplifier's accuracy and stability.
- 5) In general, surface-mount components have shorter bodies and lower parasitic reactance, giving better high-frequency performance than through-hole components.

The bypass capacitors should include a 10nF ceramic, surface-mount capacitor between each supply pin and the ground plane, located as close to the package as possible. Optionally, place a 10 μ F tantalum capacitor at the power-supply pins' point of entry to the PC board to ensure the integrity of incoming supplies. The power-supply trace should lead directly from the tantalum capacitor to the VCC and VEE pins. To minimize parasitic inductance, keep PC traces short and use surface-mount components. The N.C. pins should be connected to a common ground plane on the PC board to minimize parasitic coupling.

If input termination resistors and output back-termination resistors are used, they should be surface-mount types, and should be placed as close to the IC pins as possible. Tie all N.C. pins to the ground plane to minimize parasitic coupling.

Choosing Feedback and Gain Resistors

As with all current-feedback amplifiers, the frequency response of these devices depends critically on the value of the feedback resistor R_F . R_F combines with an internal compensation capacitor to form the dominant pole in the feedback loop. Reducing R_F 's value increases the pole frequency and the -3dB bandwidth, but also increases peaking due to interaction with other nondominant poles. Increasing R_F 's value reduces peaking and bandwidth.

Table 1 shows optimal values for the feedback resistor (R_F) and gain-setting resistor (R_G) for the MAX4223-MAX4228. Note that the MAX4224/MAX4227/MAX4228 offer superior AC performance for all gains except unity gain (0dB). These values provide optimal AC response using surface-mount resistors and good layout techniques. Maxim's high-speed amplifier evaluation kits provide practical examples of such layout techniques.

Stray capacitance at IN- causes feedback resistor decoupling and produces peaking in the frequency-response curve. Keep the capacitance at IN- as low as possible by using surface-mount resistors and by avoiding the use of a ground plane beneath or beside these resistors and the IN- pin. Some capacitance is unavoidable; if necessary, its effects can be counteracted by adjusting R_F . Use 1% resistors to maintain consistency over a wide range of production lots.

Table 1. Optimal Feedback Resistor Networks

GAIN (V/V)	GAIN (dB)	R_F (Ω)	R_G (Ω)	-3dB BW (MHz)	0.1dB BW (MHz)
MAX4223/MAX4225/MAX4226					
1	0	560*	Open	1000	300
2	6	200	200	380	115
5	14	100	25	235	65
MAX4224/MAX4227/MAX4228					
2	6	470	470	600	200
5	14	240	62	400	90
10	20	130	15	195	35

*For the MAX4223EUT, this optimal value is 470 Ω .

1GHz, Low-Power, SOT23, Current-Feedback Amplifiers with Shutdown

DC and Noise Errors

The MAX4223–MAX4228 output offset voltage, V_{OUT} (Figure 2), can be calculated with the following equation:

$$V_{OUT} = V_{OS} \times \left(1 + \frac{R_F}{R_G}\right) + I_{B+} \times R_S \\ \times \left(1 + \frac{R_F}{R_G}\right) + I_{B-} \times R_F$$

where:

V_{OS} = input offset voltage (in volts)

$1 + R_F / R_G$ = amplifier closed-loop gain (dimensionless)

I_{B+} = input bias current (in amps)

I_{B-} = inverting input bias current (in amps)

R_G = gain-setting resistor (in Ω)

R_F = feedback resistor (in Ω)

R_S = source resistor (in Ω)

The following equation represents output noise density:

$$e_n(\text{OUT}) = \left(1 + \frac{R_F}{R_G}\right) \times \\ \sqrt{\left(I_{in+} \times R_S\right)^2 + \left[I_{in-} \times \left(R_F \parallel R_G\right)\right]^2 + \left(e_n\right)^2}$$

where:

i_n = input noise current density (in $\text{pA}/\sqrt{\text{Hz}}$)

e_n = input noise voltage density (in $\text{nV}/\sqrt{\text{Hz}}$)

The MAX4223–MAX4228 have a very low, $2\text{nV}/\sqrt{\text{Hz}}$ noise voltage. The current noise at the noninverting input (i_{n+}) is $3\text{pA}/\sqrt{\text{Hz}}$, and the current noise at the inverting input (i_{n-}) is $20\text{pA}/\sqrt{\text{Hz}}$.

An example of DC-error calculations, using the MAX4224 typical data and the typical operating circuit with $R_F = R_G = 470\Omega$ ($R_F \parallel R_G = 235\Omega$) and $R_S = 50\Omega$, gives:

$$V_{OUT} = [5 \times 10^{-4} \times (1 + 1)] + [2 \times 10^{-6} \times 50 \times (1 + 1)] + \\ [4 \times 10^{-6} \times 470]$$

$$V_{OUT} = 3.1\text{mV}$$

Calculating total output noise in a similar manner yields the following:

$$e_n(\text{OUT}) = (1 + 1) \times \\ \sqrt{\left[\left(3 \times 10^{-12}\right) \times 50\right]^2 + \\ \left[\left(20 \times 10^{-12}\right) \times 235\right]^2 + \left(2 \times 10^{-9}\right)^2}$$

$$e_n(\text{OUT}) = 10.2\text{nV}/\sqrt{\text{Hz}}$$

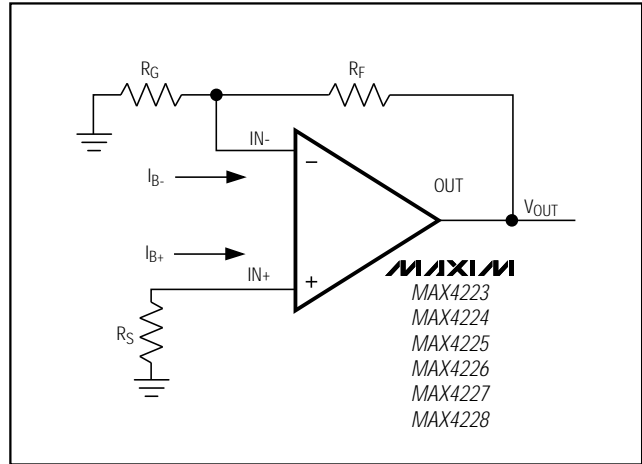

Figure 2. Output Offset Voltage

With a 600MHz system bandwidth, this calculates to $250\mu\text{VRMS}$ (approximately 1.5mVp-p, using the six-sigma calculation).

Communication Systems

Nonlinearities of components used in a communication system produce distortion of the desired output signal. Intermodulation distortion (IMD) is the distortion that results from the mixing of two input signals of different frequencies in a nonlinear system. In addition to the input signal frequencies, the resulting output signal contains new frequency components that represent the sum and difference products of the two input frequencies. If the two input signals are relatively close in frequency, the third-order sum and difference products will fall close to the frequency of the desired output and will therefore be very difficult to filter. The third-order intercept (IP3) is defined as the power level at which the amplitude of the largest third-order product is equal to the power level of the desired output signal. Higher third-order intercept points correspond to better linearity of the amplifier. The MAX4223–MAX4228 have a typical IP3 value of 42dBm, making them excellent choices for use in communications systems.

ADC Input Buffers

Input buffer amplifiers can be a source of significant errors in high-speed ADC applications. The input buffer is usually required to rapidly charge and discharge the ADC's input, which is often capacitive (see the section *Driving Capacitive Loads*). In addition, a high-speed ADC's input impedance often changes very rapidly during the conversion cycle, requiring an amplifier with

1GHz, Low-Power, SOT23, Current-Feedback Amplifiers with Shutdown

very low output impedance at high frequencies to maintain measurement accuracy. The combination of high speed, fast slew rate, low noise, and low distortion makes the MAX4223-MAX4228 ideally suited for use as buffer amplifiers in high-speed ADC applications.

Video Line Driver

The MAX4223-MAX4228 are optimized to drive coaxial transmission lines when the cable is terminated at both ends, as shown in Figure 3. Note that cable frequency response may cause variations in the signal's flatness.

Driving Capacitive Loads

A correctly terminated transmission line is purely resistive and presents no capacitive load to the amplifier. Although the MAX4223-MAX4228 are optimized for AC performance and are not designed to drive highly capacitive loads, they are capable of driving up to 25pF without excessive ringing. Reactive loads decrease phase margin and may produce excessive ringing and oscillation (see *Typical Operating Characteristics*). Figure 4's circuit reduces the effect of large capacitive loads. The small (usually 5Ω to 20Ω) isolation resistor R_{ISO} , placed before the reactive load, prevents ringing and oscillation at the expense of a

small gain error. At higher capacitive loads, AC performance is limited by the interaction of load capacitance with the isolation resistor.

Maxim's High-Speed Evaluation Board Layout

Figures 7 and 8 show a suggested layout for Maxim's high-speed, single-amplifier evaluation boards. These boards were developed using the techniques described above. The smallest available surface-mount resistors were used for the feedback and back-termination resistors to minimize the distance from the IC to these resistors, thus reducing the capacitance associated with longer lead lengths.

SMA connectors were used for best high-frequency performance. Because distances are extremely short, performance is unaffected by the fact that inputs and outputs do not match a 50Ω line. However, in applications that require lead lengths greater than 1/4 of the wavelength of the highest frequency of interest, constant-impedance traces should be used.

Fully assembled evaluation boards are available for the MAX4223 in an SO-8 package.

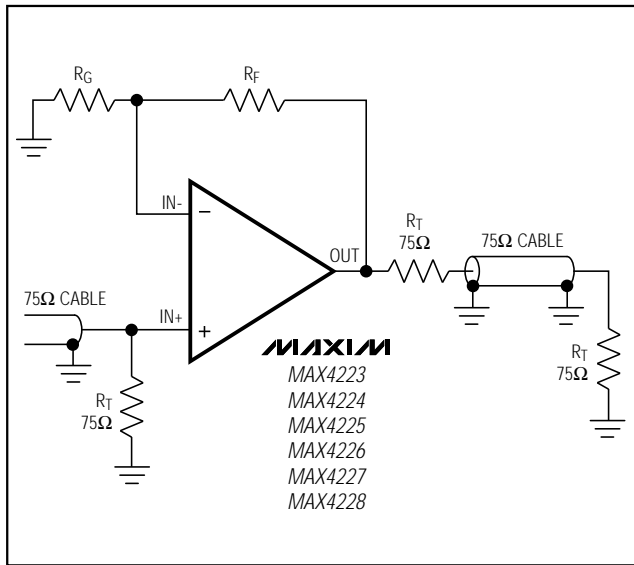

Figure 3. Video Line Driver

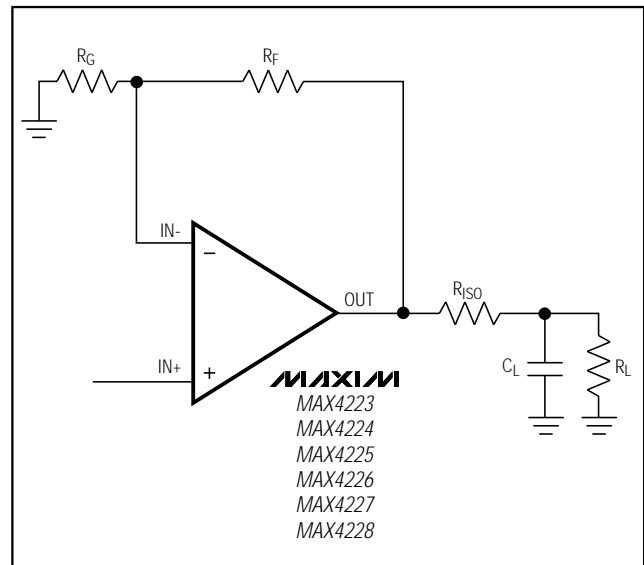

Figure 4. Using an Isolation Resistor (R_{ISO}) for High Capacitive Loads

1GHz, Low-Power, SOT23, Current-Feedback Amplifiers with Shutdown

AC Testing/Performance

AC specifications on high-speed amplifiers are usually guaranteed without 100% production testing. Since these high-speed devices are sensitive to external parasitics introduced when automatic handling equipment is used, it is impractical to guarantee AC parameters through volume production testing. These parasitics are greatly reduced when using the recommended PC board layout (like the Maxim evaluation kit). Characterizing the part in this way more accurately represents the amplifier's true AC performance. Some

manufacturers guarantee AC specifications without clearly stating how this guarantee is made. The MAX4223-MAX4228 AC specifications are derived from worst-case design simulations combined with a sample characterization of 100 units. The AC performance distributions along with the worst-case simulation limits are shown in Figures 5 and 6. These distributions are repeatable provided that proper board layout and power-supply bypassing are used (see *Layout and Power-Supply Bypassing* section).

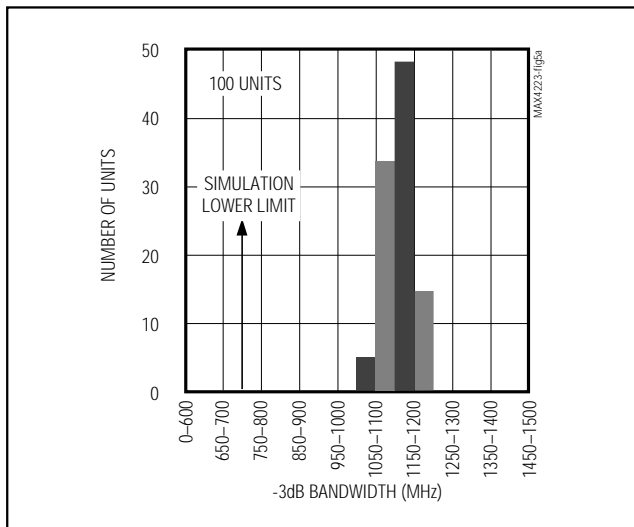

Figure 5a. MAX4223 -3dB Bandwidth Distribution

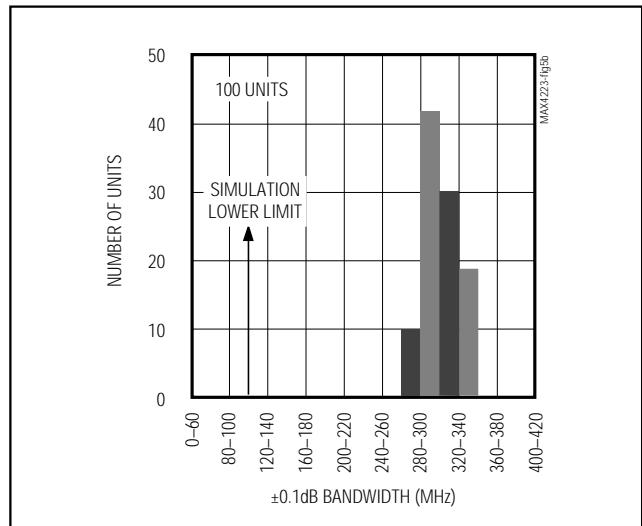

Figure 5b. MAX4223 ±0.1dB Bandwidth Distribution

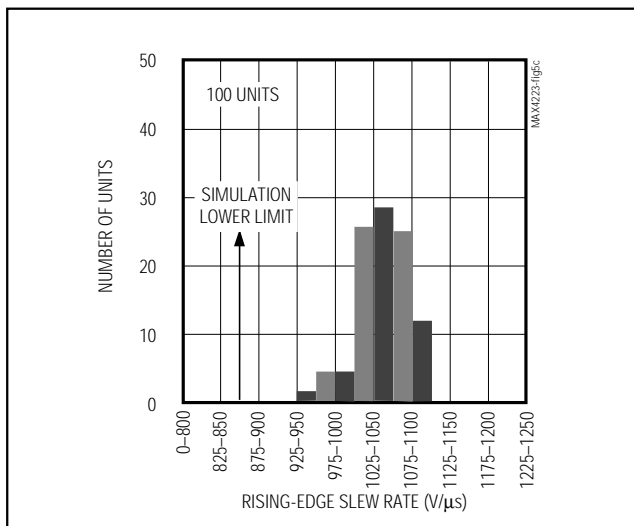

Figure 5c. MAX4223 Rising-Edge Slew-Rate Distribution

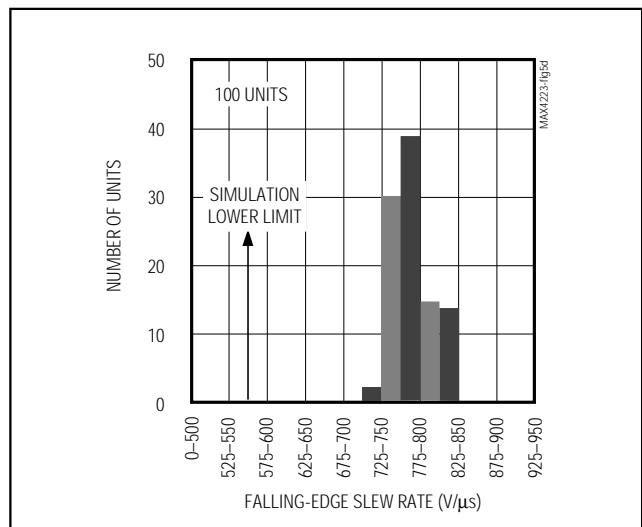

Figure 5d. MAX4223 Falling-Edge Slew-Rate Distribution

1GHz, Low-Power, SOT23, Current-Feedback Amplifiers with Shutdown

MAX4223-MAX4228

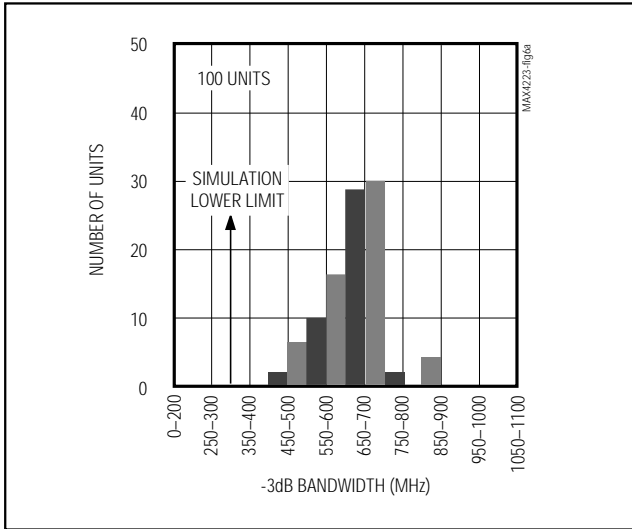

Figure 6a. MAX4224 -3dB Bandwidth Distribution

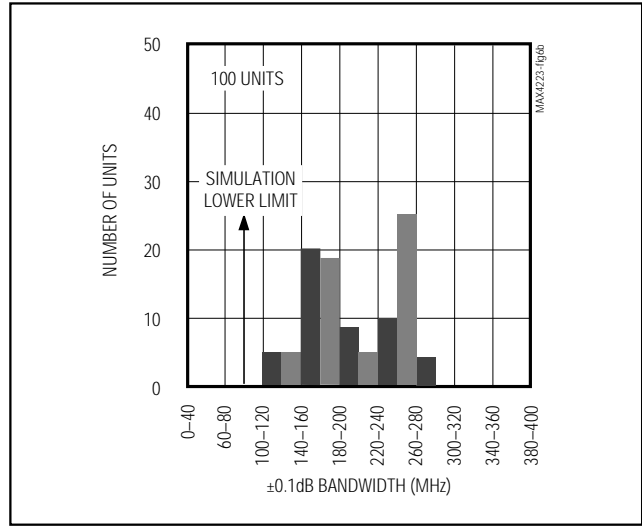

Figure 6b. MAX4224 ±0.1dB Bandwidth Distribution

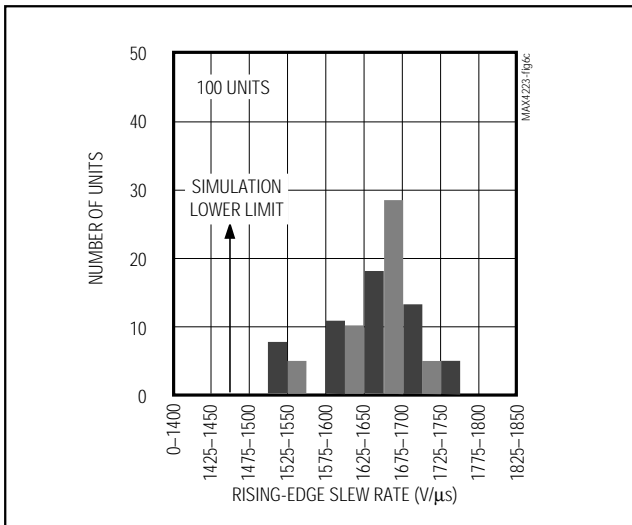

Figure 6c. MAX4224 Rising-Edge Slew-Rate Distribution

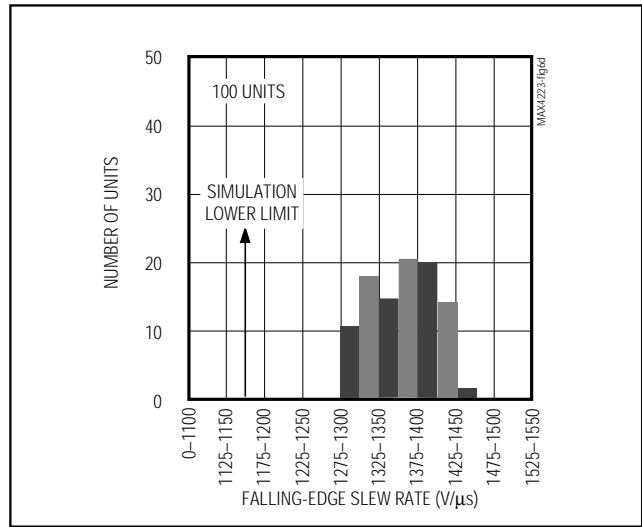

Figure 6d. MAX4224 Falling-Edge Slew-Rate Distribution

1GHz, Low-Power, SOT23, Current-Feedback Amplifiers with Shutdown

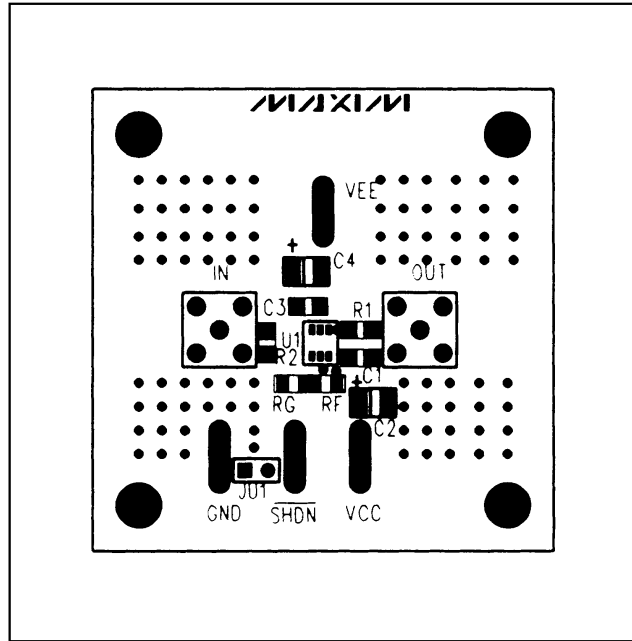

Figure 7a. Maxim SOT23 High-Speed Evaluation Board Component Placement Guide—Component Side

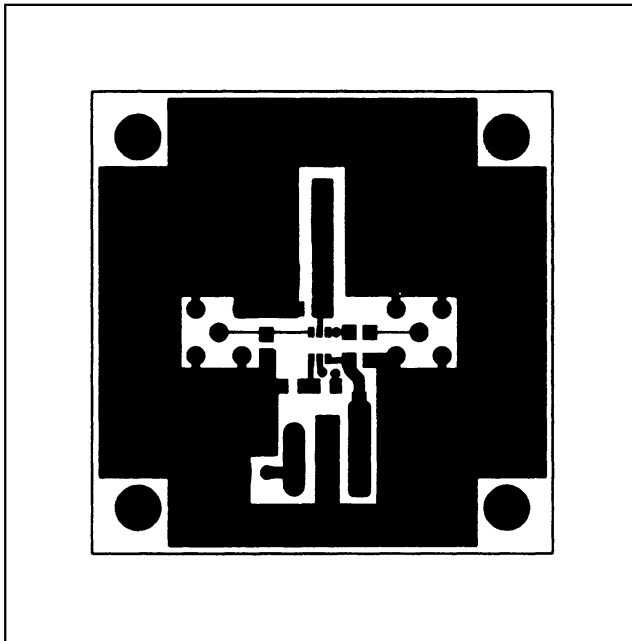

Figure 7b. Maxim SOT23 High-Speed Evaluation Board PC Board Layout—Component Side

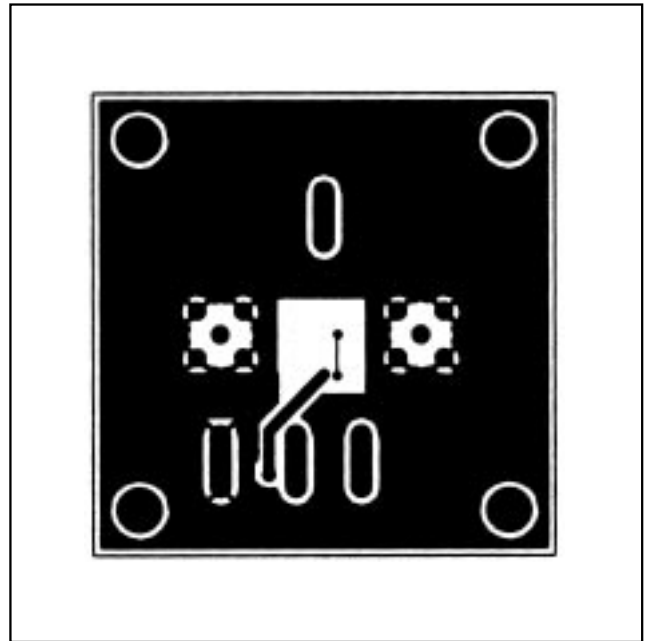

Figure 7c. Maxim SOT23 High-Speed Evaluation Board PC Board Layout—Back Side

1GHz, Low-Power, SOT23, Current-Feedback Amplifiers with Shutdown

MAX4223-MAX4228

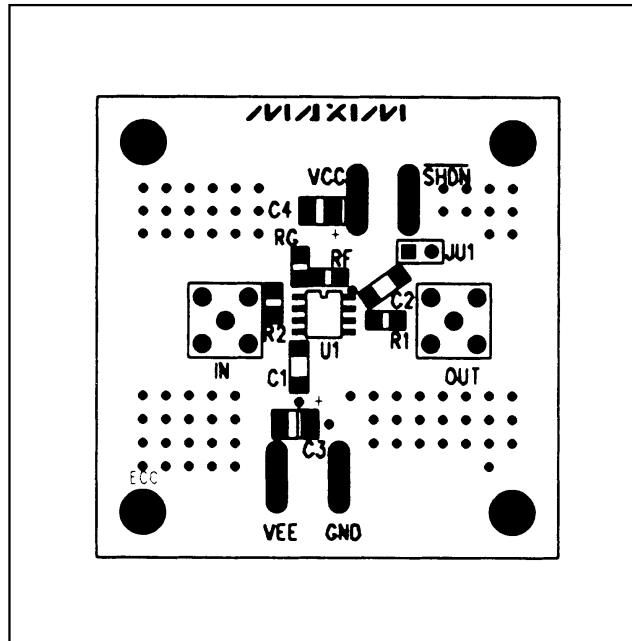

Figure 8a. Maxim SO-8 High-Speed Evaluation Board Component Placement Guide—Component Side

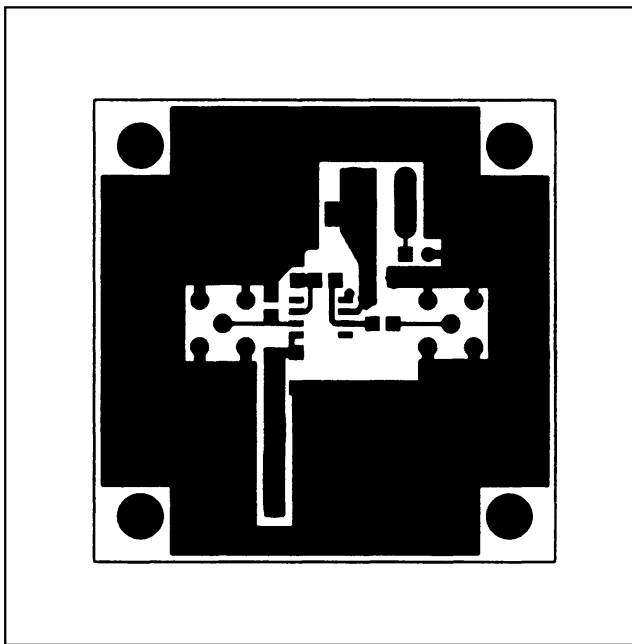

Figure 8b. Maxim SO-8 High-Speed Evaluation Board PC Board Layout—Component Side

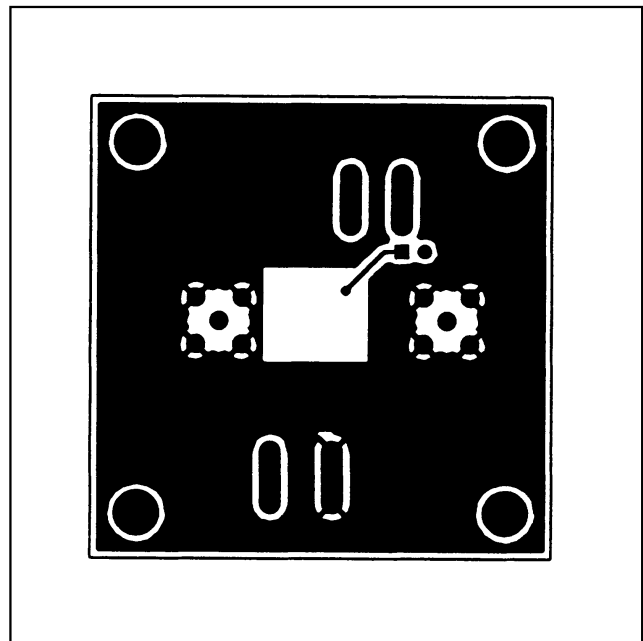
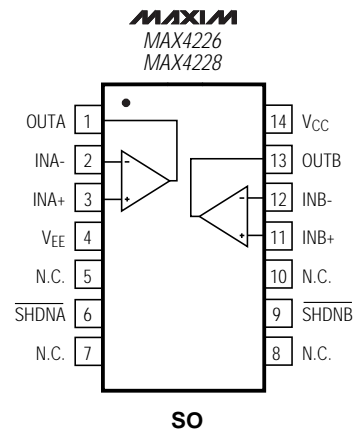
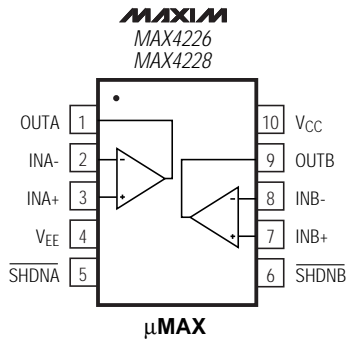
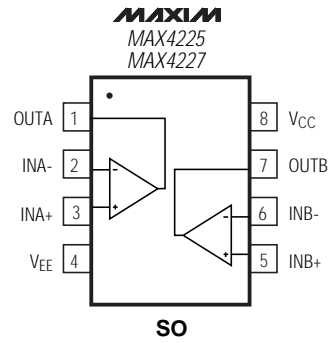
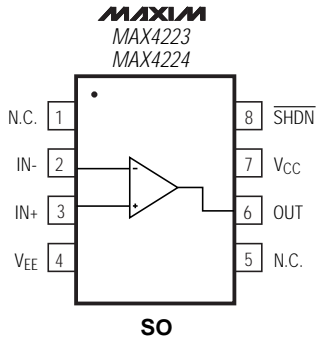

Figure 8c. Maxim SO-8 High-Speed Evaluation Board PC Board Layout—Back Side

1GHz, Low-Power, SOT23, Current-Feedback Amplifiers with Shutdown

Pin Configurations (continued)

TOP VIEW



1GHz, Low-Power, SOT23, Current-Feedback Amplifiers with Shutdown

Ordering Information (continued)

PART	TEMP. RANGE	PIN-PACKAGE	SOT TOP MARK
MAX4224 EUT-T	-40°C to +85°C	6 SOT23	AAAE
MAX4224ESA	-40°C to +85°C	8 SO	—
MAX4225 ESA	-40°C to +85°C	8 SO	—
MAX4226 EUB	-40°C to +85°C	10 μ MAX	—
MAX4226ESD	-40°C to +85°C	14 SO	—
MAX4227 ESA	-40°C to +85°C	8 SO	—
MAX4228 EUB	-40°C to +85°C	10 μ MAX	—
MAX4228ESD	-40°C to +85°C	14 SO	—

Chip Information

MAX4223/MAX4224 TRANSISTOR COUNT: 87
MAX4225–MAX4228 TRANSISTOR COUNT: 171
SUBSTRATE CONNECTED TO V_{EE}

MAX4223–MAX4228

1GHz, Low-Power, SOT23, Current-Feedback Amplifiers with Shutdown

Package Information

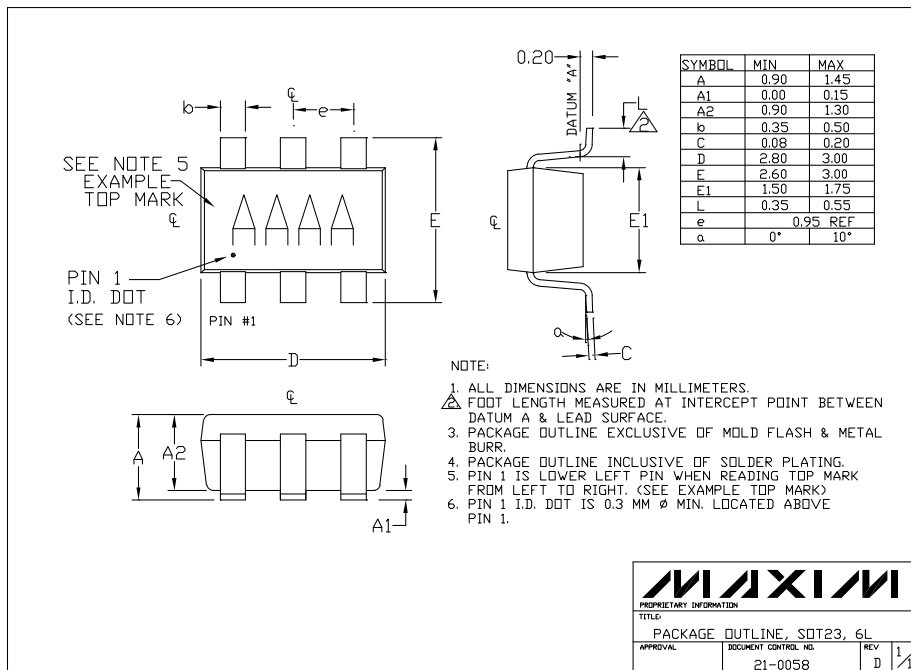
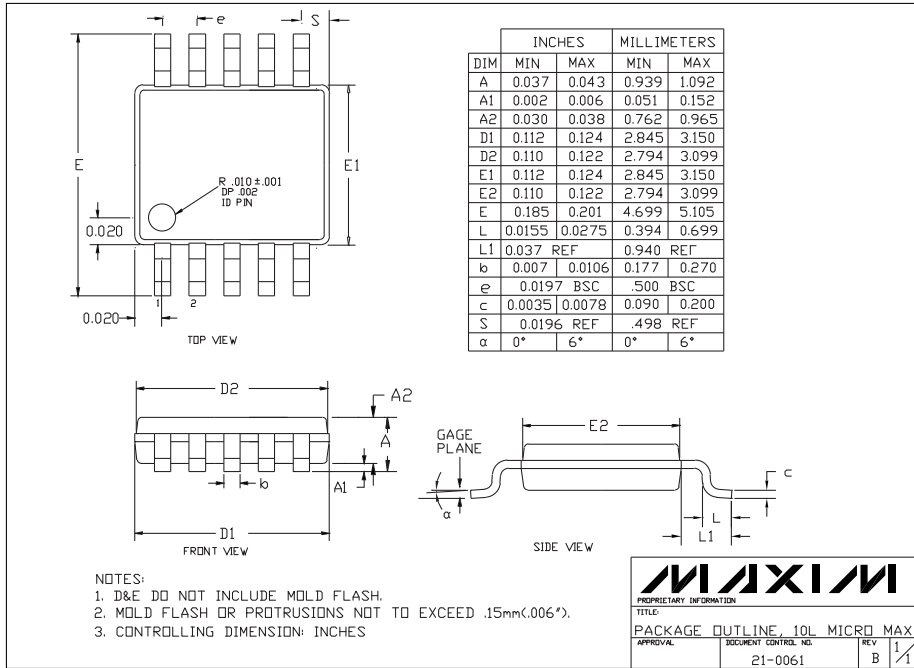

Maxim cannot assume responsibility for use of any circuitry other than circuitry entirely embodied in a Maxim product. No circuit patent licenses are implied. Maxim reserves the right to change the circuitry and specifications without notice at any time.

20 Maxim Integrated Products, 120 San Gabriel Drive, Sunnyvale, CA 94086 (408) 737-7600

Компания «Океан Электроники» предлагает заключение долгосрочных отношений при поставках импортных электронных компонентов на взаимовыгодных условиях!

Наши преимущества:

- Поставка оригинальных импортных электронных компонентов напрямую с производств Америки, Европы и Азии, а так же с крупнейших складов мира;
- Широкая линейка поставок активных и пассивных импортных электронных компонентов (более 30 млн. наименований);
- Поставка сложных, дефицитных, либо снятых с производства позиций;
- Оперативные сроки поставки под заказ (от 5 рабочих дней);
- Экспресс доставка в любую точку России;
- Помощь Конструкторского Отдела и консультации квалифицированных инженеров;
- Техническая поддержка проекта, помощь в подборе аналогов, поставка прототипов;
- Поставка электронных компонентов под контролем ВП;
- Система менеджмента качества сертифицирована по Международному стандарту ISO 9001;
- При необходимости вся продукция военного и аэрокосмического назначения проходит испытания и сертификацию в лаборатории (по согласованию с заказчиком);
- Поставка специализированных компонентов военного и аэрокосмического уровня качества (Xilinx, Altera, Analog Devices, Intersil, Interpoint, Microsemi, Actel, Aeroflex, Peregrine, VPT, Syfer, Eurofarad, Texas Instruments, MS Kennedy, Miteq, Cobham, E2V, MA-COM, Hittite, Mini-Circuits, General Dynamics и др.);

Компания «Океан Электроники» является официальным дистрибьютором и эксклюзивным представителем в России одного из крупнейших производителей разъемов военного и аэрокосмического назначения «JONHON», а так же официальным дистрибьютором и эксклюзивным представителем в России производителя высокотехнологичных и надежных решений для передачи СВЧ сигналов «FORSTAR».



JONHON

«JONHON» (основан в 1970 г.)

Разъемы специального, военного и аэрокосмического назначения:

(Применяются в военной, авиационной, аэрокосмической, морской, железнодорожной, горно- и нефтедобывающей отраслях промышленности)

«FORSTAR» (основан в 1998 г.)

ВЧ соединители, коаксиальные кабели, кабельные сборки и микроволновые компоненты:

(Применяются в телекоммуникациях гражданского и специального назначения, в средствах связи, РЛС, а так же военной, авиационной и аэрокосмической отраслях промышленности).



Телефон: 8 (812) 309-75-97 (многоканальный)

Факс: 8 (812) 320-03-32

Электронная почта: ocean@oceanchips.ru

Web: <http://oceanchips.ru/>

Адрес: 198099, г. Санкт-Петербург, ул. Калинина, д. 2, корп. 4, лит. А