

SpaceNXT™ AURORA Series

Hard Metric Backplane Connector System



SpaceNXT - AURORA Series



Smiths Interconnect's SpaceNXT product portfolio provides customers with a combination of highly reliable technology and lower cost of ownership that enable operators to overcome potential market entry barriers while enjoying the benefits of an established technology partner.

SpaceNXT Aurora Series offers a high reliability backplane interconnect solution in a form factor widely accepted across the market.

Tested to the ESA 3401 specification, SpaceNXT Aurora Series has demonstrated its ability to survive the rigors of most space applications, so it can be designed in with confidence. The connector system also complies with the widely used Hard Metric CompactPCI® specification, making it easily integrated into existing platform architecture. It's footprint and envelope compatible with COTS 2mm, allowing for use of the wide range of available accessories, such as guide hardware.

This connector range delivers a broad set of features and benefits to customers by addressing their high-reliability connectivity needs. The Aurora Series features enhanced gold plating with 1.27µm (50 µin) coverage on contact mating surfaces, which provides consistent durability, improved contact resistance stability, and greater resistance to fretting versus alternate plating materials. Additionally, Aurora meets customers' performance requirements without the need for lubricants, which can cause secondary contamination, while offering electrical stability throughout the product's life. Developed specifically for the commercial space applications, this Series is designed to perform in operating environments that feature extremely harsh conditions.

The SpaceNXT Aurora series incorporates rugged stamped and formed contacts, making it the most cost effective space grade, backplane connector solution on the market.

High reliability hard metric backplane connectors specifically designed and tested for next generation commercial space applications

Features & Benefits

COTS Plus solution

- 2mm Hard Metric CompactPCI® compatible
- Available in 55, 110, and 125 contacts
- Right angle and mezzanine configurations press-fit termination

Tested and Qualified to ESA 3401 Specification

- Proven capability for space applications

1.27 µm gold contacts

- Improved durability and reliability versus standard COTS plating
- Contact resistance stability
- Improved performance against fretting corrosion

Lubricant Free Contacts

- Eliminates potential contamination of contacts

AS9100 certified

- Additional site audits not required

The connector utilizes press-fit termination, providing lower cost of application and no need for inspection of solder joints.

Each lot of Aurora Space is subjected to a quality conformance inspection, in order to insure consistent quality and performance. A copy of the qualification test report (QTR) is available upon request.

Technical Characteristics

Quality Conformance Inspections	MIL-DTL-55302
Design Criteria	IEC 61076-4-101
Contact Spacing	0.079 [2.00]
Suggested PCB Hole Diameter	0.024 [0.60] ± 0.002 [0.05] after plating

Mechanical & Environmental

Insulation Resistance	> 10,000 MΩ
Low Level Contact Resistance	20 mΩ max
Mating Force	0.17 LBF per mating contact
Contact Life Cycle	200 per mated connector pair
Temperature Rating	-55° C to 125° C
Flammability Rating	UL 94V0
Mechanical Shock	30 G peak value (GR-1217-CORE Telecordia)
Vibration	10-500 Hz @ 10 G (GR-1217-CORE Telecordia)

Materials & Finishes

Insulator	Female housing: PBT UL94 V-0 Male housing: PBT UL94 V-0 Wafer: LCP UL94 V-0
Contact	Copper alloy
Mating Contact Plating	1.27 μm [50 μin] gold min. over 1.27 μm [50 μin] nickel min.
Press Fit PCB Termination	2.50 μm [98 μin] tin min. over 1.27 μm [50 μin] nickel min.

Electrical

Current Rating	1.0 A @ 20°C
Voltage Rating	500 VAC
Dielectric Withstanding Voltage	750V RMS

Dimensions 55, 110 & 125 way connectors

55-Way Male Type C, Straight

STRAIGHT
P/N: K3SC055MSOP1230



STRAIGHT WITH PEG
P/N: K3SC055MS1P1230



55-Way Female Type C, Straight & Right Angle

STRAIGHT
P/N: K3SC055FSOP14301



RIGHT ANGLE
P/N: K3SC055FR0P1430

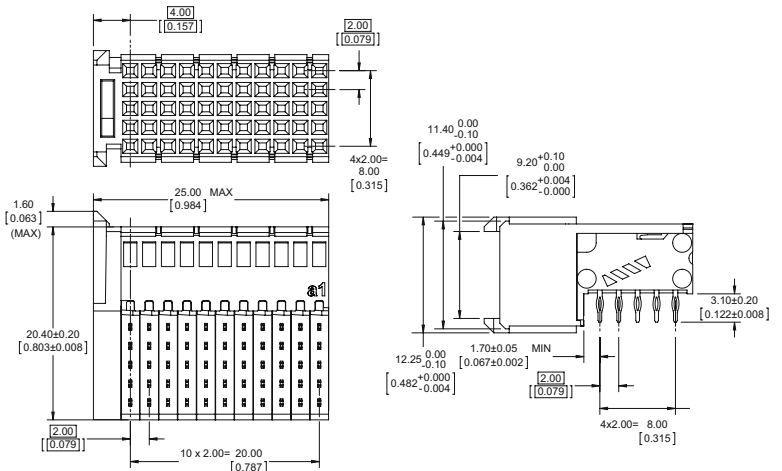

Dimension are in mm and inches

Dimensions 55, 110 & 125 way connectors

110-Way Male

Type A, Straight

STRAIGHT

P/N: K3SA110MSOP1230

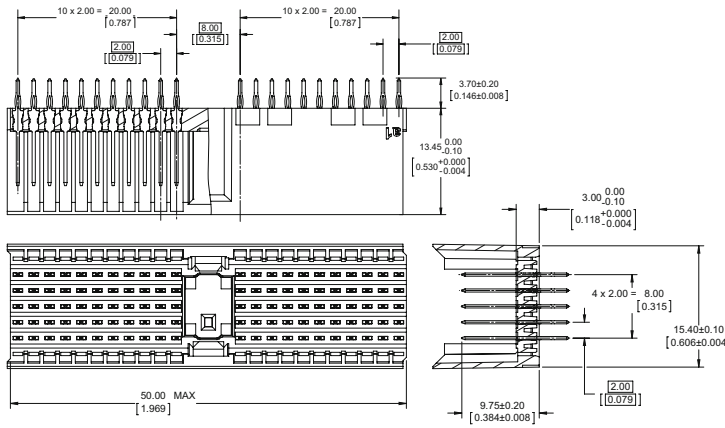

STRAIGHT WITH PEG

P/N: K3SA110MS1P1230

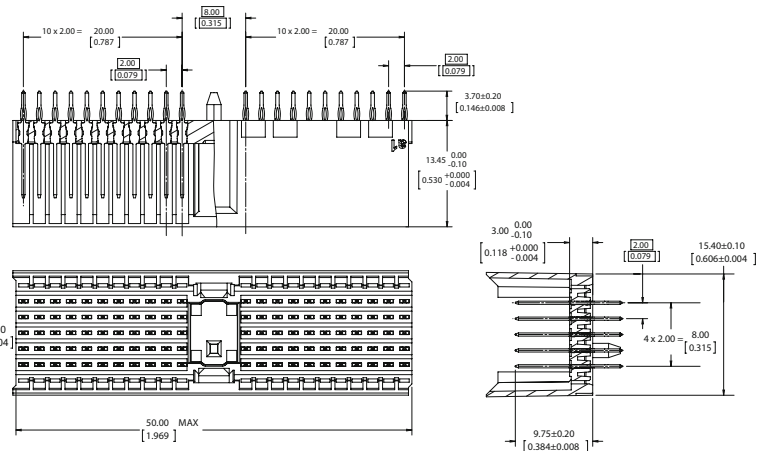

110-Way Female

Type A, Straight & Right Angle

STRAIGHT

P/N: K3SA110FSOP14301

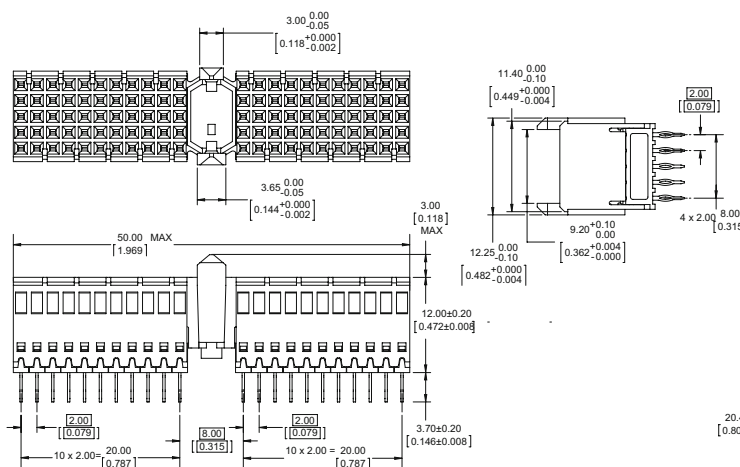

RIGHT ANGLE

P/N: K3SA110FR0P1430

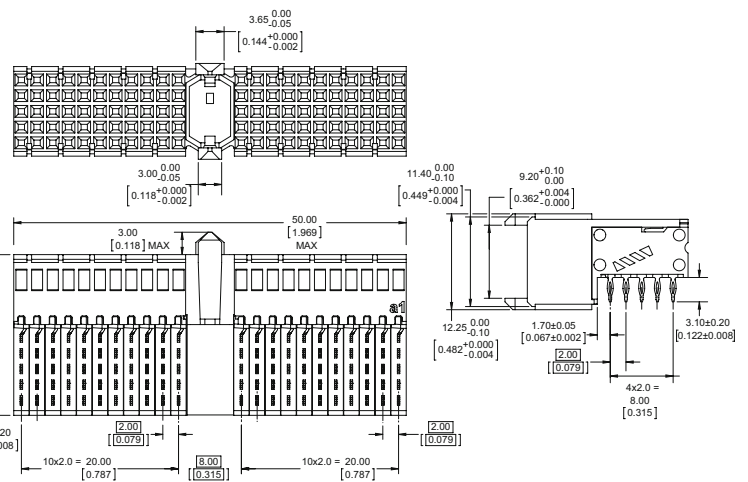

Dimension are in mm and inches

Dimensions *55, 110 & 125 way connectors*

125-Way Male Type B, Straight

STRAIGHT
P/N: K3SB125MSOP1230

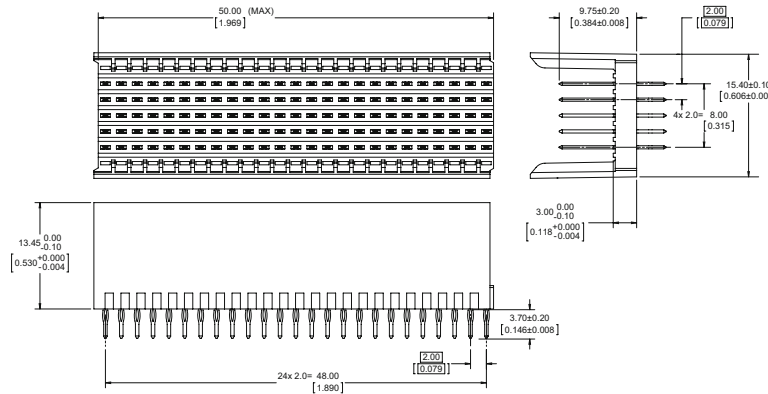

125-Way Female Type B, Straight & Right Angle

STRAIGHT
P/N: K3SB125FSOP14301

RIGHT ANGLE
P/N: K3SB125FROP1430

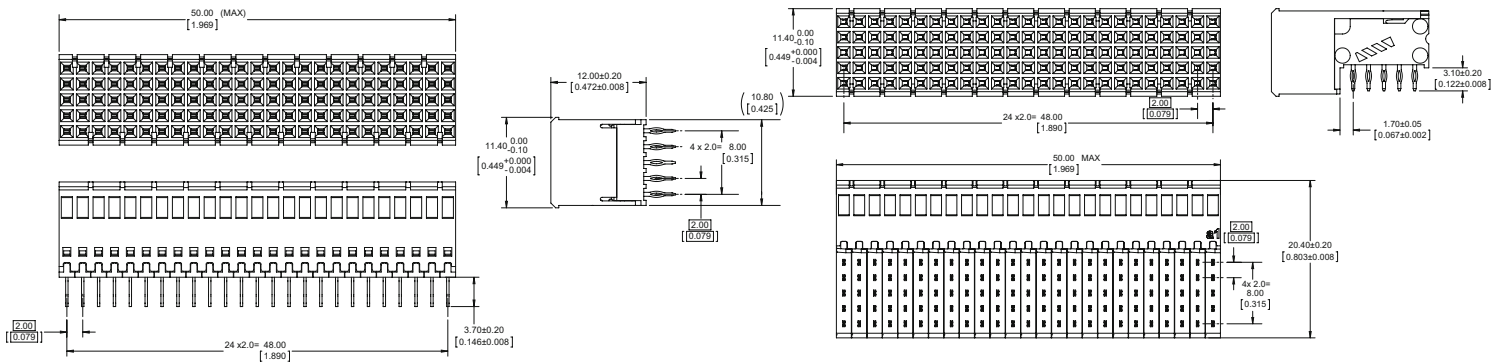

Dimension are in mm and inches

How To Order



1 Connector Series	K 3 S AURORA series [fixed]
2 Connector type⁽¹⁾	A Multi-purpose centre B Without multi-purpose centre C End module
3 Number of contacts⁽¹⁾	0 5 5 55 contacts 1 1 0 110 contacts 1 2 5 125 contacts
4 Contact gender	M Male F Female
5 Termination style	S Straight R Right angle
6 Alignment peg	0 Without peg 1 With peg
7 Termination⁽¹⁾	P Press-fit
8 Termination length⁽¹⁾	1 3.10 mm (right angle) or 3.70 mm (straight)
9 Signal pin length x shielding pins length⁽¹⁾	2 9.75 mm 4 Female
10 Plating	3 1.27 µm [50 µin] (min) gold over 1.27-2.54 µm [50-100 µin] (min) nickel on mating contact surfaces 2.54-5.08 µm [100-200 µin] (min) tin over 1.27-3.81 µm [50-150 µin] (min) nickel on pcb termination
11 Shield	0 No shield
12 Version⁽¹⁾ (Female only)	1 Board-to-board distance: 15-16.5 mm

Notes:

(1) For specific options, please consult factory

Global Support

UK Headquarters

- London, UK
+44 20 7004 1600
info.uk@smithsinterconnect.com

US Headquarters

- Stuart, FL
+1 772 286 9300
info.us@smithsinterconnect.com

Americas

- Costa Mesa, CA
+1 714 371 1100
info.us@smithsinterconnect.com
- Milpitas, CA
+1 408 957 9607 x 1125
info.us@smithsinterconnect.com
- Stuart, FL
+1 772 286 9300
info.us@smithsinterconnect.com
- Hudson, MA
+1 978 568 0451
info.us@smithsinterconnect.com
- Northampton, MA
+1 413 582 9620
info.northampton@smithsinterconnectinc.com
- Tampa, FL
+1 813 901 7200
info.tampa@smithsinterconnectinc.com
- Kansas City, KS
+1 913 342 5544
info.us@smithsinterconnect.com
- Salisbury, MD
+1 800 780 2169
info.us@smithsinterconnect.com
- Thousand Oaks, CA
+1 805 267 0100
info.thousandoaks@smithsinterconnectinc.com

Europe

- Deggendorf, Germany
+49 991 250 120
info.de@smithsinterconnect.com
- Genoa, Italy
+39 0 10 60361
info.it@smithsinterconnect.com
- Dundee, UK
+44 1382 427 200
info.dundee@smithsinterconnect.com
- Rouen, France
+33 2 32 96 91 76
info.fr@smithsinterconnect.com
- Elstree, UK
+44 20 8236 2400
info.uk@smithsinterconnect.com

Asia

- Shanghai, China
+86 21 2283 8008
info.asia@smithsinterconnect.com
- Suzhou, China
+86 512 6273 1188
info.asia@smithsinterconnect.com
- Singapore
+65 6846 1655
info.asia@smithsinterconnect.com

Компания «Океан Электроники» предлагает заключение долгосрочных отношений при поставках импортных электронных компонентов на взаимовыгодных условиях!

Наши преимущества:

- Поставка оригинальных импортных электронных компонентов напрямую с производств Америки, Европы и Азии, а так же с крупнейших складов мира;
- Широкая линейка поставок активных и пассивных импортных электронных компонентов (более 30 млн. наименований);
- Поставка сложных, дефицитных, либо снятых с производства позиций;
- Оперативные сроки поставки под заказ (от 5 рабочих дней);
- Экспресс доставка в любую точку России;
- Помощь Конструкторского Отдела и консультации квалифицированных инженеров;
- Техническая поддержка проекта, помощь в подборе аналогов, поставка прототипов;
- Поставка электронных компонентов под контролем ВП;
- Система менеджмента качества сертифицирована по Международному стандарту ISO 9001;
- При необходимости вся продукция военного и аэрокосмического назначения проходит испытания и сертификацию в лаборатории (по согласованию с заказчиком);
- Поставка специализированных компонентов военного и аэрокосмического уровня качества (Xilinx, Altera, Analog Devices, Intersil, Interpoint, Microsemi, Actel, Aeroflex, Peregrine, VPT, Syfer, Eurofarad, Texas Instruments, MS Kennedy, Miteq, Cobham, E2V, MA-COM, Hittite, Mini-Circuits, General Dynamics и др.);

Компания «Океан Электроники» является официальным дистрибьютором и эксклюзивным представителем в России одного из крупнейших производителей разъемов военного и аэрокосмического назначения «**JONHON**», а так же официальным дистрибьютором и эксклюзивным представителем в России производителя высокотехнологичных и надежных решений для передачи СВЧ сигналов «**FORSTAR**».



JONHON

«**JONHON**» (основан в 1970 г.)

Разъемы специального, военного и аэрокосмического назначения:

(Применяются в военной, авиационной, аэрокосмической, морской, железнодорожной, горно- и нефтедобывающей отраслях промышленности)

«**FORSTAR**» (основан в 1998 г.)

ВЧ соединители, коаксиальные кабели,
кабельные сборки и микроволновые компоненты:

(Применяются в телекоммуникациях гражданского и специального назначения, в средствах связи, РЛС, а так же военной, авиационной и аэрокосмической отраслях промышленности).



Телефон: 8 (812) 309-75-97 (многоканальный)

Факс: 8 (812) 320-03-32

Электронная почта: ocean@oceanchips.ru

Web: <http://oceanchips.ru/>

Адрес: 198099, г. Санкт-Петербург, ул. Калинина, д. 2, корп. 4, лит. А