

# **CTVS – Ceramic transient voltage suppressors**

SMD multilayer varistors (MLVs),  
automotive E series

**Series/Type:**

Date: December 2019

## Multilayer varistors (MLVs)

### Automotive E series

#### SMD

#### EPCOS type designation system for automotive series, single chips

CT	0603	S	14	B	AUTO	E2	G2
<b>Construction:</b> CT $\triangleq$ Single chip with nickel barrier termination (AgNiSn)							
<b>EAI case sizes:</b> 0402 0603 0805 1206 1210 1812 2220							
<b>Varistor voltage tolerance:</b> K $\triangleq$ $\pm 10\%$ , standard L $\triangleq$ $\pm 10\%$ , standard S $\triangleq$ Special tolerance							
<b>Maximum RMS operating voltage (<math>V_{RMS}</math>):</b> 14 $\triangleq$ 14 V $V_{RMS} < 25$ V are suitable for 12 V DC supply systems $V_{RMS} \geq 25$ V are suitable for 24 V DC supply systems							
<b>Special tolerance for the varistor voltage:</b> – $\triangleq$ Standard tolerance A or B $\triangleq$ Special tolerance							
– $\triangleq$ Standard series AUTO $\triangleq$ specified for load-dump/ jump-start protection (except CT0603S14BAUTOG and CT0805K17AUTOLCG)							
<b>Special features:</b> – $\triangleq$ Standard energy handling capability E2 $\triangleq$ Increased energy handling capability HT $\triangleq$ High temperature version LC $\triangleq$ Low capacitance version CC $\triangleq$ Controlled capacitance version RF $\triangleq$ Radio frequency							
<b>Taping mode:</b> G $\triangleq$ Taped, 180-mm reel, 7" G2 $\triangleq$ Taped, 330-mm reel, 13"							

**Multilayer varistors (MLVs)**
**Automotive E series**
SMD
**EPCOS type designation system for automotive series, array**

CA	05	M2	S	10	T	100	H	G
<b>Construction:</b> CA $\triangleq$ Array with nickel barrier termination (AgNiSn)								
<b>EAI case sizes:</b> 05 $\triangleq$ 0508 array								
M2 $\triangleq$ Array with two elements								
<b>Varistor voltage tolerance:</b> S $\triangleq$ Special tolerance								
<b>Maximum RMS operating voltage (<math>V_{RMS}</math>):</b> 10 $\triangleq$ 10 V								
<b>Internal coding</b>								
<b>Capacitance value:</b> 100 $\triangleq$ 10 · 10 <sup>0</sup> pF $\triangleq$ 100 pF								
<b>Maximum capacitance matching tolerance:</b> H $\triangleq$ 3%								
<b>Taping mode:</b> G $\triangleq$ Taped, 180-mm reel, 7"								

## Multilayer varistors (MLVs)

### Automotive E series

#### SMD

#### Features

- Reliable ESD protection up to 30 kV acc. to IEC 61000-4-2, level 4 (8 kV contact, 15 kV air)
- High energy absorption capability
- Low leakage current
- Long-term ESD stability
- Bidirectional protection
- No temperature derating up to 150 °C
- RoHS-compatible, lead-free
- Nickel barrier suitable for lead-free soldering
- Qualification based on AEC-Q200
- PSpice simulation models available

#### Applications

- Transient overvoltage protection in automotive applications: engine management, airbag, control units, electrohydraulic brake, ABS/ESP, sunroof
- Load-dump protection
- Jump-start protection

#### Design

- Multilayer technology
- Flammability rating better than UL 94 V-0
- Termination (see “Soldering directions”):
  - CT types with nickel barrier terminations (AgNiSn), recommended for lead-free reflow and wave soldering, and compatible with tin/lead solder.

#### V/I characteristics and derating curves

V/I and derating curves are attached to the data sheet. The curves are sorted by  $V_{RMS}$  and then by case size, which is included in the type designation.

#### Single chip

##### Internal circuit



MLV0006-H

##### Available case sizes:

EIA	Metric
0402	1005
0603	1608
0805	2012
1206	3216
1210	3225
1812	4532
2220	5750

## Multilayer varistors (MLVs)

### Automotive E series

#### SMD

#### Description for ESD/ EMI filter array

The ESD/EMI filter array provides an ideal combination of EMI filtering and ESD protection for high-speed bus system transceivers such as Ethernet and Flexray.

#### Features

- ESD protection acc. to IEC 61000-4-2, level 4
- Capacitance deviation between array elements  
 $C_1$  and  $C_2$ : < 3%
- Max. relative capacitance change: < 0.1%/K
- Low leakage current
- Load-dump/ jump-start resistant
- Stable protection level
- Bidirectional protection
- No temperature derating up to 125 °C
- RoHS-compatible, lead-free
- Qualification based on AEC-Q200

#### Applications

- Load-dump protection
- Jump-start protection

#### Design

- Two multilayer varistors with a common ground CT types with nickel barrier terminations (AgNiSn), recommended for lead-free reflow and wave soldering, and compatible with tin/lead solder.
- Flammability rating better than UL 94 V-0
- Termination (see "Soldering directions"):
  - CT types with nickel barrier terminations (AgNiSn), recommended for lead-free reflow and wave soldering, and compatible with tin/lead solder.

#### 2-fold array

Internal circuit



Model of EMI filtering with matched capacitances  $C_1$  and  $C_2$



Available case sizes:

EIA	Metric
0508	1220

## Multilayer varistors (MLVs)

### Automotive E series

### SMD

#### General technical data

Maximum RMS operating voltage		$V_{RMS,max}$	10 ... 40	V
Maximum DC operating voltage		$V_{DC,max}$	12 ... 56	V
Maximum surge current	(8/20 $\mu$ s)	$I_{surge,max}$	2 ... 1200	A
Maximum load dump energy	(10 pulses)	$W_{LD}$	1 ... 25	J
Maximum jump-start voltage	(5 min)	$V_{jump}$	24.5 ... 45	V
Maximum clamping voltage		$V_{clamp,max}$	35 ... 290	V
Operating temperature		$T_{op}$	-55/+150	°C
Storage temperature		LCT/UCT	-55/+150	°C
Response time		$t_{resp}$	< 0.5	ns

#### Temperature derating

Climatic category: -55/+150 °C

for single chips

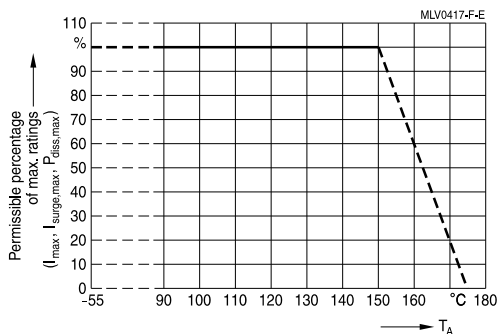

Climatic category: -40/+125 °C

for ESD/ EMI filter array and single chips type CT0402S20AHSG\_P/ CT0603S20AHSG\_P

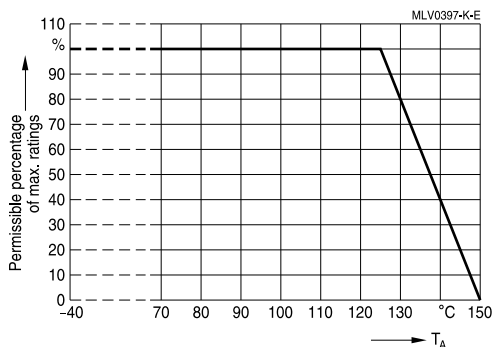

**Multilayer varistors (MLVs)**
**Automotive E series**
SMD
**Electrical specifications and ordering codes**
**Maximum ratings ( $T_{op,max}$ ), automotive standard series<sup>1)</sup>**

Type	Ordering code	$V_{RMS,max}$	$V_{DC,max}$	$W_{max}$	$P_{diss,max}$	$V_V$	$\Delta V_V$
		V	V	(2 ms) mJ	mW	(1 mA) V	%
CT0805K11G	B72510E0110K062	11	14	200	5	18	±10
CT0402L14G	B72590E0140L060	14	16	30	3	23.5	±15
CT0603K14G	B72500E0140K060	14	18	200	3	22	±10
CT0603S14AHSG	B72500E8140S160	14	16	30	3	28	±20
CT0603S14BG	B72500E0140S260	14	18	200	3	24.5	±15
CT0603V150RFG	B72500E7151V060	14	16	-	-	150	±35
CT0805K14G	B72510E0140K062	14	18	300	3	22	±10
CT1206K14G	B72520E0140K062	14	18	500	8	22	±10
CT1210K14G	B72530E0140K062	14	18	1500	10	22	±10
CT1812K14G	B72580E0140K062	14	18	2300	15	22	±10
CT2220K14G	B72540E0140K062	14	18	5800	20	22	±10
CT0402S17AG	B72590E0170S160	17	19	10	3	32.5	±25
CT0603K17G	B72500E0170K060	17	22	200	3	27	±10
CT0603K17LCG	B72500E2170K060	17	22	100	1	27	±10
CT0603S17ALCG	B72500E2170S160	17	22	75	3	32.5	±25
CT0603S17BCCG	B72500E5170S260	17	22	75	3	32.5	±25
CT0805K17G	B72510E0170K062	17	22	300	5	27	±10
CT1206K17G	B72520E0170K062	17	22	600	8	27	±10
CT1210K17G	B72530E0170K062	17	22	1700	10	27	±10
CT1812K17G	B72580E0170K062	17	22	2700	15	27	±10
CT2220K17G	B72540E0170K062	17	22	7200	20	27	±10
CT0402S20AHSG_P	B72590P8200S060	20	24	-	-	≥ 100	-
CT0603K20G	B72500E0200K060	20	26	200	3	33	±10
CT0603S20ACCG	B72500E5200S160	20	26	300	3	36	±20
CT0603S20AHSG_P	B72500P8200S060	20	24	-	-	≥ 100	-
CT0805K20G	B72510E0200K062	20	26	300	5	33	±10
CT0805S20ACCG2G2	B72510E9200S172	20	26	400	5	34.5	±15
CT1206K20G	B72520E0200K062	20	26	700	8	33	±10
CT1210K20G	B72530E0200K062	20	26	1900	10	33	±10
CT1812K20G	B72580E0200K062	20	26	3000	15	33	±10
CT2220K20G	B72540E0200K062	20	26	7800	20	33	±10
CT0603K25G	B72500E0250K060	25	31	300	3	39	±10
CT0603L25HSG	B72500E8250L060	25	32	50	-	61	±15
CT0603L25HTCCG	B72500E5250L060	25	32	50	-	61	±15
CT0805K25G	B72510E0250K062	25	31	300	5	39	±10

1)  $W_{LD}$  and  $V_{jump}$  values are not specified for automotive standard series.

**Multilayer varistors (MLVs)**
**Automotive E series**
**SMD**
**Characteristics (T<sub>A</sub> = 25 °C)**

Type	V <sub>clamp,max</sub> V	I <sub>surge,max</sub> (8/20) μs) A	I <sub>clamp</sub> (8/20) μs) A	C <sub>typ</sub> <sup>2)</sup> pF	C <sub>min</sub> <sup>2)</sup> pF	C <sub>max</sub> <sup>2)</sup> pF	I <sub>leak,max</sub> μA	I <sub>leak</sub> μA
CT0805K11G	35	120	1	400	-	-	20@14 V	-
CT0402L14G	46	8	1	15	-	-	1@16 V	<1@14 V
CT0603K14G	40	30	1	100	-	-	20@18 V	<1@14 V
CT0603S14AHSG	66	5	1	15	-	30	1@16 V	<1@14 V
CT0603S14BG	42	30	1	120	-	-	5@18 V	<1@14 V
CT0603V150RFG	290	-	1	3	-	5	3@16 V	-
CT0805K14G	40	120	1	350	-	-	30@18V	1@14 V
CT1206K14G	38	200	1	700	-	-	70@18 V	<5@14 V
CT1210K14G	38	400	2.5	2000	-	-	70@18 V	<5@14 V
CT1812K14G	38	800	5	4500	-	-	90@18 V	<5@14 V
CT2220K14G	38	1200	10	10000	-	-	80@18 V	<10@14 V
CT0402S17AG	59	6	1	15	-	-	1@16 V	<1@14 V
CT0603K17G	46	30	1	100	-	-	30@22 V	<1@14 V
CT0603K17LCG	50	10	1	30	-	50	20@22 V	<1@14 V
CT0603S17ALCG	50	30	1	50	-	75	5@22 V	<1@14 V
CT0603S17BCCG	50	30	1	53	31.8	74.2	5@22 V	<1@14 V
CT0805K17G	46	120	1	400	-	-	50@22 V	1@14 V
CT1206K17G	44	200	1	650	-	-	70@22 V	<2@14 V
CT1210K17G	44	400	2.5	1800	-	-	50@22 V	1@14 V
CT1812K17G	44	800	5	4000	-	-	35@22 V	<2@14 V
CT2220K17G	44	1200	10	9000	-	-	70@22 V	<5@14 V
CT0402S20AHSG_P	-	-	-	4.7	-	5.7	1@24 V	-
CT0603K20G	56	30	1	90	-	-	20@26 V	<1@14 V
CT0603S20ACCG	67	30	1	80	64	96	5@26 V	<1@14 V
CT0603S20AHSG_P	-	-	-	4.7	-	5.7	1@24 V	-
CT0805K20G	56	80	1	300	-	-	20@26 V	<1@14 V
CT0805S20ACCG2G2	64	80	1	220	170	270	10@22 V	1@28 V
CT1206K20G	54	200	1	600	-	-	10@26 V	<1@14 V
CT1210K20G	54	400	2.5	1500	-	-	20@26 V	1@14 V
CT1812K20G	54	800	5	3000	-	-	60@26 V	<1@14 V
CT2220K20G	54	1200	10	7000	-	-	70@26 V	<2@14 V
CT0603K25G	67	30	1	90	-	-	10@31 V	1@28 V
CT0603L25HSG	120	5	1	10	-	15	1@32 V	<1@14 V
CT0603L25HTCCG	120	5	1	10	5	15	1@32 V	<1@28 V
CT0805K25G	67	80	1	250	-	-	25@31 V	5@28 V

2) Measurement frequency: f = 1 MHz for C < 100 pF, f = 1 KHz for C ≥ 100 pF



**Multilayer varistors (MLVs)**
**Automotive E series**
**SMD**
**Electrical specifications and ordering codes**
**Maximum ratings ( $T_{op,max}$ ), automotive standard series<sup>1)</sup>**

Type	Ordering code	$V_{RMS,max}$	$V_{DC,max}$	$W_{max}$	$P_{diss,max}$	$V_V$	$\Delta V_V$
		V	V	(2 ms) mJ	mW	(1 mA) V	%
CT1206K25G	B72520E0250K062	25	31	1000	8	39	±10
CT1210K25G	B72530E0250K062	25	31	1700	10	39	±10
CT1812K25G	B72580E0250K062	25	31	3700	15	39	±10
CT2220K25G	B72540E0250K062	25	31	9600	20	39	±10
CT0805K30G	B72510E0300K062	30	38	300	5	47	±10
CT1206K30G	B72520E0300K062	30	38	1100	8	47	±10
CT1210K30G	B72530E0300K062	30	38	2000	10	47	±10
CT1812K30G	B72580E0300K062	30	38	4200	15	47	±10
CT2220K30G	B72540E0300K062	30	38	12000	20	47	±10
CT0805K35G	B72510E0350K062	35	45	300	5	56	±10
CT1206K35G	B72520E0350K062	35	45	400	8	56	±10
CT1210K35G	B72530E0350K062	35	45	2000	10	56	±10
CT1812K35G	B72580E0350K062	35	45	4000	15	56	±10
CT2220K35G	B72540E0350K062	35	45	7700	20	56	±10
CT1206K40G	B72520E0400K062	40	56	500	8	68	±10
CT2220K40G	B72540E0400K062	40	56	9000	20	68	±10

1)  $W_{LD}$  and  $V_{jump}$  values are not specified for automotive standard series.

**Multilayer varistors (MLVs)**
**Automotive E series**
**SMD**
**Characteristics (T<sub>A</sub> = 25 °C)**

Type	V <sub>clamp,max</sub> V	I <sub>surge,max</sub> (8/20) μs) A	I <sub>clamp</sub> (8/20) μs) A	C <sub>typ</sub> <sup>2)</sup> pF	C <sub>min</sub> <sup>2)</sup> pF	C <sub>max</sub> <sup>2)</sup> pF	I <sub>leak,max</sub> μA	I <sub>leak</sub> μA
CT1206K25G	65	200	1	550	-	-	10@31 V	2.5@28 V
CT1210K25G	65	300	2.5	1500	-	-	25@31 V	10@28 V
CT1812K25G	65	800	5	2500	-	-	-	-
CT2220K25G	65	1200	10	5000	-	-	110@31 V	<40@28 V
CT0805K30G	77	80	1	200	-	-	40@38 V	1@28 V
CT1206K30G	77	200	1	500	-	-	25@38 V	2@28 V
CT1210K30G	77	300	2.5	1000	-	-	20@38 V	1@28 V
CT1812K30G	77	800	5	2000	-	-	70@38 V	5@28 V
CT2220K30G	77	1200	10	4000	-	-	50@38 V	<5@28 V
CT0805K35G	95	80	1	150	-	-	-	-
CT1206K35G	90	100	1	200	-	-	20@45 V	<1@28 V
CT1210K35G	90	250	2.5	600	-	-	20@45 V	1@28 V
CT1812K35G	90	500	5	1200	-	-	30@45 V	1@27 V
CT2220K35G	90	1000	10	2500	-	-	50@45 V	<2@28 V
CT1206K40G	110	100	1	250	-	-	20@56 V	<1@28 V
CT2220K40G	110	1000	10	2000	-	-	120@56 V	<1@28 V

2) Measurement frequency: f = 1 MHz for C < 100 pF, f = 1 KHz for C ≥ 100 pF

**Multilayer varistors (MLVs)**
**Automotive E series**
**SMD**
**Electrical specifications and ordering codes**
**Maximum ratings ( $T_{op,max}$ )**
**Automotive series with load-dump/ jump-start protection<sup>1)</sup>**

Type	Ordering code	$V_{RMS,max}$	$V_{DC,max}$	$I_{surge,max}$ (8/20 $\mu$ s)	$W_{max}$ (2 ms)	$W_{LD}$ (10 pulses)	$P_{diss,max}$
		V	V	A	mJ	J	mW
CT0603S14BAUTOG	B72500E1140S260	14	16	30	200	-	3
CT0805S14BAUTOG	B72510E1140S262	14	16	120	300	1	8
CT1206S14BAUTOG	B72520E1140S262	14	16	200	600	1.5	8
CT1210S14BAUTOG	B72530E1140S262	14	16	400	1600	3	10
CT1812S14BAUTOE2G2	B72580E3140S272	14	16	800	2400	12	15
CT1812S14BAUTOG	B72580E1140S262	14	16	800	2400	6	15
CT2220S14BAUTOE2G2	B72540E3140S272	14	16	1200	5800	25	30
CT2220S14BAUTOG	B72540E1140S262	14	16	1200	5800	12	30
CT0805K17AUTOLCG	B72510E2170K062	17	22	30	100	-	4
CT1210K17AUTOG	B72530E1170K062	17	22	400	1700	3	10
CT1206K20AUTOG	B72520E1200K062	20	26	200	700	1.5	8
CT1210K20AUTOG	B72530E1200K062	20	26	400	1900	3	10
CT0805K25AUTOG	B72510E1250K062	25	31	80	300	1	5
CT1206K25AUTOG	B72520E1250K062	25	31	200	1000	1.5	8
CT1210K25AUTOG	B72530E1250K062	25	31	300	1700	3	10
CT2220K30AUTOE2G2	B72540E3300K072	30	34	1200	12000	25	30
CT2220K30AUTOG	B72540E1300K062	30	34	1200	12000	12	30

1)  $C_{min}$  and  $C_{max}$  values are not specified for standard automotive series with load dump/ jump start specification.

**Multilayer varistors (MLVs)**
**Automotive E series**
**SMD**
**Characteristics (T<sub>A</sub> = 25 °C)**

Type	V <sub>V</sub> (1 mA)  V	ΔV <sub>V</sub>  %	V <sub>jump</sub> (5 min)  V	V <sub>clamp,max</sub>  V	I <sub>clamp</sub> (8/20 μs)  A	C <sub>typ</sub> (1 kHz)  pF	I <sub>leak,max</sub>  μA	I <sub>leak</sub>  μA
CT0603S14BAUTOG	24.5	±15	24.5	42	1	120	1@16 V	<1@14 V
CT0805S14BAUTOG	24.5	±15	24.5	42	1	400	5@16 V	1@14 V
CT1206S14BAUTOG	24.5	±15	24.5	40	1	800	5@16 V	<2.5@14 V
CT1210S14BAUTOG	24.5	±15	24.5	40	2.5	2000	5@16 V	<2.5@14 V
CT1812S14BAUTOE2G2	24.5	±15	24.5	40	5	7000	10@16 V	3@14 V
CT1812S14BAUTOG	24.5	±15	24.5	40	5	5600	10@16 V	3@14 V
CT2220S14BAUTOE2G2	24.5	±15	24.5	40	10	15000	20@16 V	10@14 V
CT2220S14BAUTOG	24.5	±15	24.5	40	10	9500	10@16 V	5@14 V
CT0805K17AUTOLCG	29	±15	-	50	1	100	10@22 V	1@14 V
CT1210K17AUTOG	27	±10	26.5	44	2.5	2000	50@22 V	1@14 V
CT1206K20AUTOG	33	±10	27	54	1	600	10@26 V	<1@14 V
CT1210K20AUTOG	33	±10	27	54	2.5	1500	20@26 V	1@14 V
CT0805K25AUTOG	39	±10	29	67	1	250	25@22 V	5@28 V
CT1206K25AUTOG	39	±10	29	65	1	550	10@31 V	2.5@28 V
CT1210K25AUTOG	39	±10	29	65	2.5	1500	25@31 V	10@28 V
CT2220K30AUTOE2G2	47	±10	45	77	10	10000	40@34 V	10@28 V
CT2220K30AUTOG	47	±10	45	77	10	4000	20@34 V	5@28 V

**Multilayer varistors (MLVs)**
**Automotive E series**
**SMD**
**Electrical specifications and ordering codes**
**Maximum ratings ( $T_{op,max}$ )**
**Automotive series, array specification**

Type	Ordering code	$V_{RMS,max}$	$V_{DC,max}$	$I_{surge,max}$ (8/20 $\mu$ s)	$W_{max}$ (2 ms)	$V_{LD}$ (10 pulses, 300 ms)	$P_{diss,max}$
		V	V	A	mJ	V	mW
CA05M2S10T100HG	B72812Q1120S160	10	12	5	10	27	3

**Characteristics ( $T_A = 25\text{ }^\circ\text{C}$ )**

Type	$V_V$ (1 mA)	$\Delta V_V$	$V_{jump}$ (60 s)	$V_{clamp,max}$	$I_{clamp}$ (8/20 $\mu$ s)	$C_{typ}$ (1 MHz)	$C_{max}$ (1 MHz)	$I_{leak,max}$
	V	%	V	V	A	pF	pF	$\mu$ A
CA05M2S10T100HG	26	$\pm 20$	28	60	1	10	15	0.5@5 V

**Note:**

Pulse derating curve is not specified for automotive array CA05M2S10T100HG.

## Multilayer varistors (MLVs)

### Automotive E series

#### SMD

#### Dimensional drawings

##### Single chip

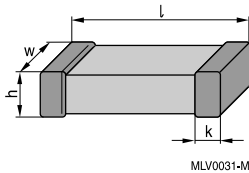

Case size EIA / mm	l	w	h	k
0402 / 1005	1.0 ±0.15	0.50 ±0.10	0.6 max.	0.10 ... 0.30
0603 / 1608	1.6 ±0.15	0.80 ±0.10	0.9 max.	0.10 ... 0.40
0805 / 2012	2.0 ±0.20	1.25 ±0.15	1.4 max.	0.13 ... 0.75
1206 / 3216	3.2 ±0.30	1.60 ±0.20	1.7 max.	0.25 ... 0.75
1210 / 3225	3.2 ±0.30	2.50 ±0.25	1.7 max.	0.25 ... 0.75
1812 / 4532	4.5 ±0.40	3.20 ±0.30	2.5 max.	0.25 ... 1.00
2220 / 5750	5.7 ±0.40	5.00 ±0.40	2.5 max.	0.25 ... 1.00

##### 2-fold MCV array

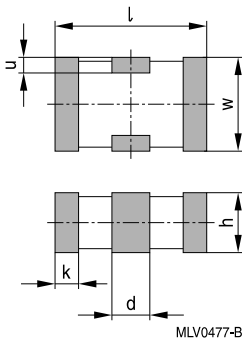

Case size EIA / mm	l	w	h	d	k	u
0508 / 1220	2.0 ±0.20	1.25 ±0.15	0.9 max.	0.50 ±0.20	0.30 ±0.20	0.20 ±0.10

Dimensions in mm

## Multilayer varistors (MLVs)

### Automotive E series

#### SMD

#### Recommended solder pad layout

##### Single chip



Dimensions in mm

Case size EIA / mm	A	B	C
0402 / 1005	0.60	0.60	0.50
0603 / 1608	1.00	1.00	1.00
0805 / 2012	1.40	1.20	1.00
1206 / 3216	1.80	1.20	2.10
1210 / 3225	2.80	1.20	2.10
1812 / 4532	3.60	1.50	3.00
2220 / 5750	5.50	1.50	4.20

##### 2-fold MCV array



Dimensions in mm

Case size EIA / mm	A	B	C	D	E
0508 / 1220	1.00	1.30	0.40	0.60	2.16

**Multilayer varistors (MLVs)**
**Automotive E series**
SMD
**Delivery mode**

EIA case size	Taping	Reel size mm	Packing unit pcs.	Type	Ordering code
<b>Array</b>					
0508	Cardboard	180	4000	CA05M2S10T100HG	B72812Q1120S160
<b>Single chip</b>					
0402	Cardboard	180	10000	CT0402L14G	B72590E0140L060
0402	Cardboard	180	10000	CT0402S17AG	B72590E0170S160
0402	Cardboard	180	10000	CT0402S20AHSG_P	B72590P8200S060
0603	Cardboard	180	4000	CT0603K14G	B72500E0140K060
0603	Cardboard	180	4000	CT0603K17G	B72500E0170K060
0603	Cardboard	180	4000	CT0603K17LCG	B72500E2170K060
0603	Cardboard	180	4000	CT0603K20G	B72500E0200K060
0603	Cardboard	180	4000	CT0603K25G	B72500E0250K060
0603	Cardboard	180	4000	CT0603L25HSG	B72500E8250L060
0603	Cardboard	180	4000	CT0603L25HTCCG	B72500E5250L060
0603	Cardboard	180	4000	CT0603S14AHSG	B72500E8140S160
0603	Cardboard	180	4000	CT0603S14BAUTOG	B72500E1140S260
0603	Cardboard	180	4000	CT0603S14BG	B72500E0140S260
0603	Cardboard	180	4000	CT0603S17ALCG	B72500E2170S160
0603	Cardboard	180	4000	CT0603S17BCCG	B72500E5170S260
0603	Cardboard	180	4000	CT0603S20ACCG	B72500E5200S160
0603	Cardboard	180	4000	CT0603S20AHSG_P	B72500P8200S060
0603	Cardboard	180	4000	CT0603V150RFG	B72500E7151V060
0805	Blister	180	3000	CT0805K11G	B72510E0110K062
0805	Blister	180	3000	CT0805K14G	B72510E0140K062
0805	Blister	180	3000	CT0805K17AUTOLCG	B72510E2170K062
0805	Blister	180	3000	CT0805K17G	B72510E0170K062
0805	Blister	180	3000	CT0805K20G	B72510E0200K062
0805	Blister	180	3000	CT0805K25AUTOG	B72510E1250K062
0805	Blister	180	3000	CT0805K25G	B72510E0250K062
0805	Blister	180	3000	CT0805K30G	B72510E0300K062
0805	Blister	180	3000	CT0805K35G	B72510E0350K062
0805	Blister	180	3000	CT0805S14BAUTOG	B72510E1140S262
0805	Blister	330	12000	CT0805S20ACC2G2	B72510E9200S172
1206	Blister	180	2000	CT1206K25AUTOG	B72520E1250K062
1206	Blister	180	2000	CT1206K25G	B72520E0250K062
1206	Blister	180	2000	CT1206K30G	B72520E0300K062
1206	Blister	180	2000	CT1206K35G	B72520E0350K062
1206	Blister	180	2000	CT1206K40G	B72520E0400K062
1206	Blister	180	3000	CT1206K14G	B72520E0140K062
1206	Blister	180	3000	CT1206K17G	B72520E0170K062
1206	Blister	180	3000	CT1206K20AUTOG	B72520E1200K062
1206	Blister	180	3000	CT1206K20G	B72520E0200K062
1206	Blister	180	3000	CT1206S14BAUTOG	B72520E1140S262



**Multilayer varistors (MLVs)**
**Automotive E series**
SMD

EIA case size	Taping	Reel size mm	Packing unit pcs.	Type	Ordering code
1210	Blister	180	2000	CT1210K20AUTOG	B72530E1200K062
1210	Blister	180	2000	CT1210K20G	B72530E0200K062
1210	Blister	180	2000	CT1210K25AUTOG	B72530E1250K062
1210	Blister	180	2000	CT1210K25G	B72530E0250K062
1210	Blister	180	2000	CT1210K30G	B72530E0300K062
1210	Blister	180	2000	CT1210K35G	B72530E0350K062
1210	Blister	180	3000	CT1210K14G	B72530E0140K062
1210	Blister	180	3000	CT1210K17AUTOG	B72530E1170K062
1210	Blister	180	3000	CT1210K17G	B72530E0170K062
1210	Blister	180	3000	CT1210S14BAUTOG	B72530E1140S262
1812	Blister	180	1000	CT1812K25G	B72580E0250K062
1812	Blister	180	1000	CT1812K30G	B72580E0300K062
1812	Blister	180	1000	CT1812K35G	B72580E0350K062
1812	Blister	180	1500	CT1812K14G	B72580E0140K062
1812	Blister	180	1500	CT1812K17G	B72580E0170K062
1812	Blister	180	1500	CT1812K20G	B72580E0200K062
1812	Blister	180	1500	CT1812S14BAUTOG	B72580E1140S262
1812	Blister	330	3000	CT1812S14BAUTOE2G2	B72580E3140S272
2220	Blister	180	1000	CT2220K25G	B72540E0250K062
2220	Blister	180	1000	CT2220K30AUTOG	B72540E1300K062
2220	Blister	180	1000	CT2220K30G	B72540E0300K062
2220	Blister	180	1000	CT2220K35G	B72540E0350K062
2220	Blister	180	1000	CT2220K40G	B72540E0400K062
2220	Blister	180	1500	CT2220K14G	B72540E0140K062
2220	Blister	180	1500	CT2220K17G	B72540E0170K062
2220	Blister	180	1500	CT2220K20G	B72540E0200K062
2220	Blister	180	1500	CT2220S14BAUTOG	B72540E1140S262
2220	Blister	330	3000	CT2220K30AUTOE2G2	B72540E3300K072
2220	Blister	330	3000	CT2220S14BAUTOE2G2	B72540E3140S272

**Multilayer varistors (MLVs)**

**Automotive E series**

**SMD**

**V/I characteristics for automotive standard series**

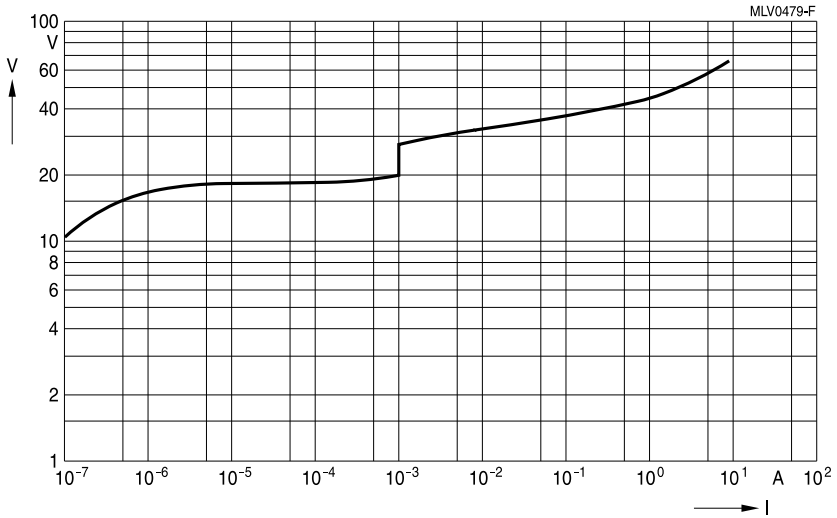

CT0402L14G

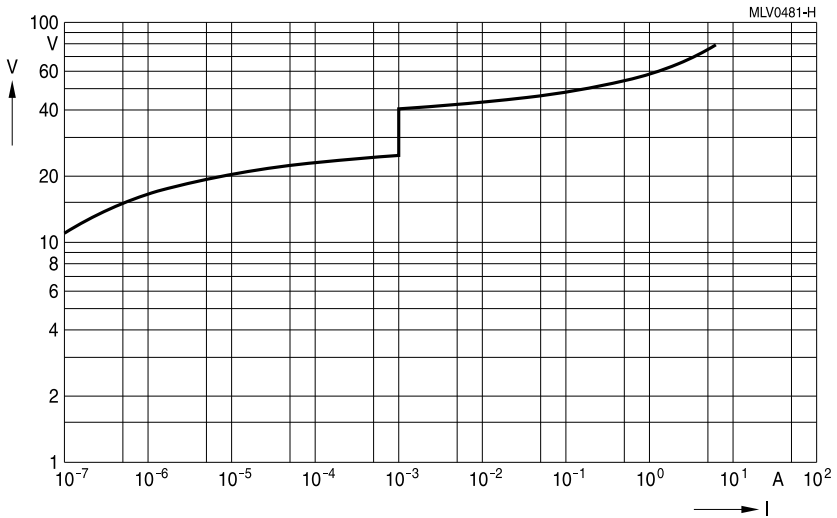

CT0402S17AG

**Multilayer varistors (MLVs)**

**Automotive E series**

**SMD**

**V/I characteristics for automotive standard series**



CT0402S20AHSG\_P



CT0603K14G

**Multilayer varistors (MLVs)**

**Automotive E series**

**SMD**

**V/I characteristics for automotive standard series**



CT0603S14AHSG



CT0603S14BG

**Multilayer varistors (MLVs)**

**Automotive E series**

**SMD**

**V/I characteristics for automotive standard series**



CT0603K17G



CT0603K17LCG

Multilayer varistors (MLVs)

Automotive E series

SMD

V/I characteristics for automotive standard series



CT0603S17ALCG  
CT0603S17BCCG



CT0603K20G

**Multilayer varistors (MLVs)**

**Automotive E series**

**SMD**

**V/I characteristics for automotive standard series**



CT0603S20ACCG

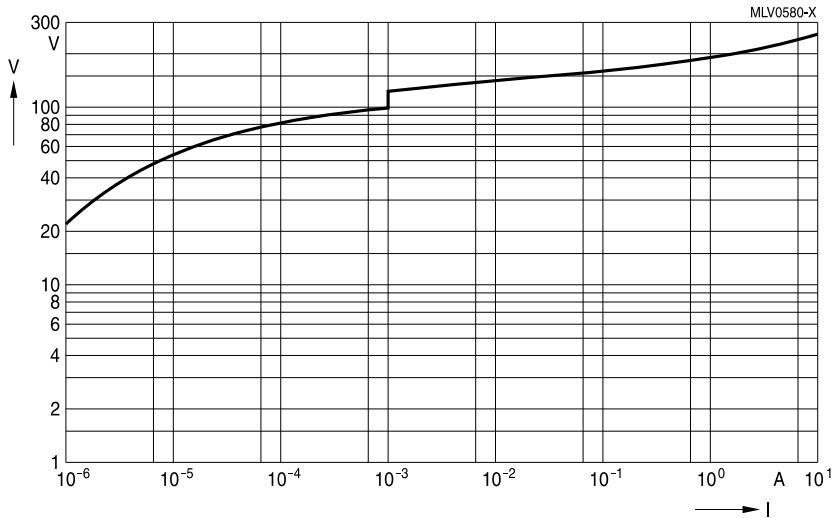

CT0603S20AHSG\_P

**Multilayer varistors (MLVs)**

**Automotive E series**

**SMD**

**V/I characteristics for automotive standard series**



CT0603K25G



Multilayer varistors (MLVs)

Automotive E series

SMD

V/I characteristics for automotive standard series

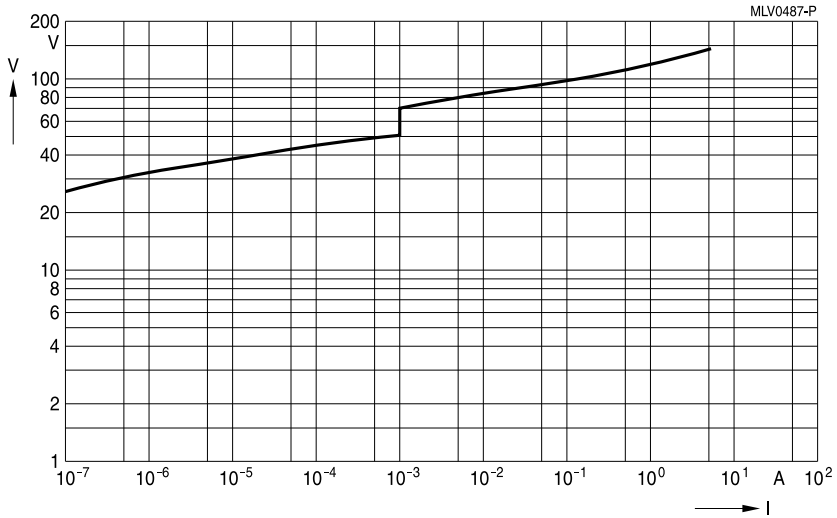

CT0603L25HSG  
CT0603L25HTCCG

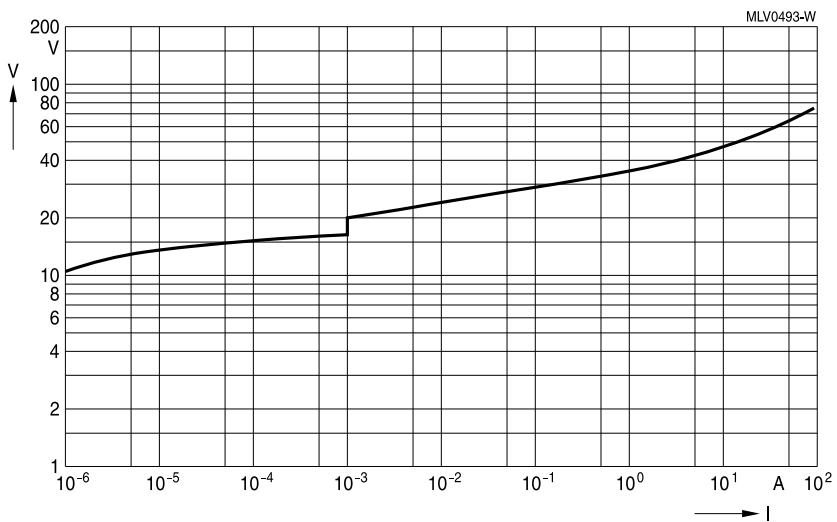

CT0805K11G

Multilayer varistors (MLVs)

Automotive E series

SMD

V/I characteristics for automotive standard series



CT0805K14G



CT0805K17G

**Multilayer varistors (MLVs)**

**Automotive E series**

**SMD**

**V/I characteristics for automotive standard series**



**CT0805K20G**



**CT0805S20ACC2G2**

Multilayer varistors (MLVs)

Automotive E series

SMD

V/I characteristics for automotive standard series



CT0805K25G



CT0805K30G

**Multilayer varistors (MLVs)**

**Automotive E series**

**SMD**

**V/I characteristics for automotive standard series**



**CT0805K35G**



**CT1206K14G**

**Multilayer varistors (MLVs)**

**Automotive E series**

**SMD**

**V/I characteristics for automotive standard series**

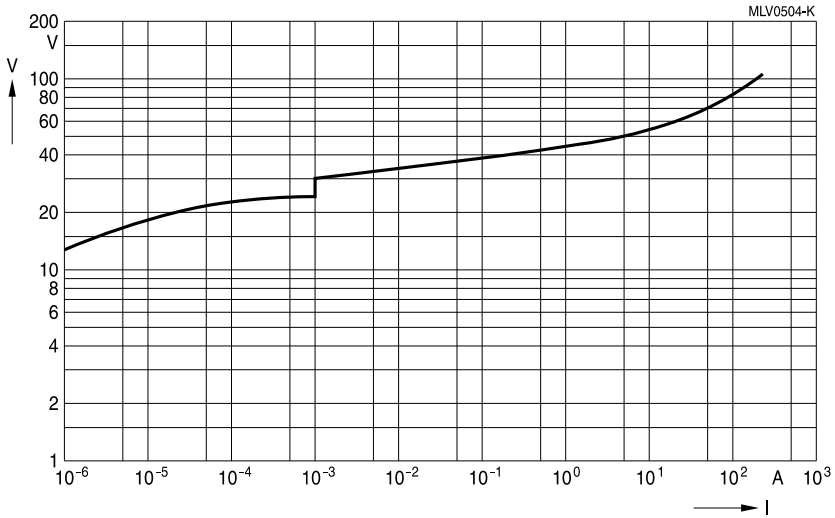

CT1206K17G

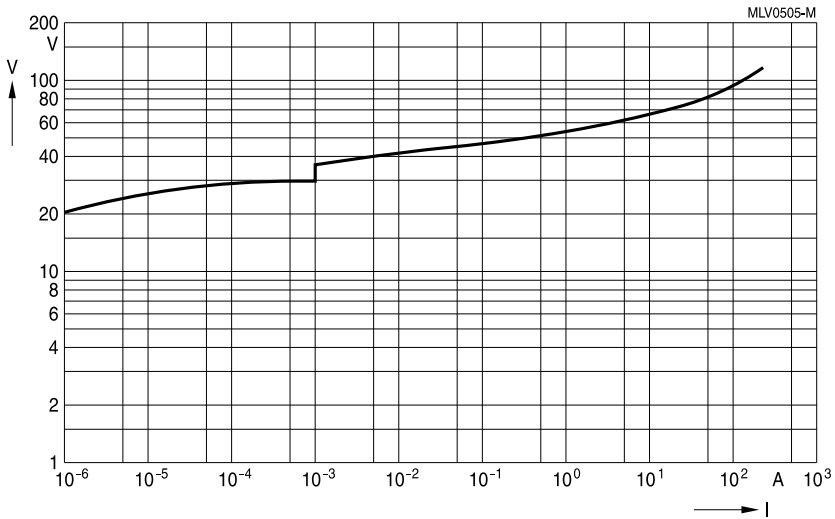

CT1206K20G

**Multilayer varistors (MLVs)**

**Automotive E series**

**SMD**

**V/I characteristics for automotive standard series**



CT1206K25G

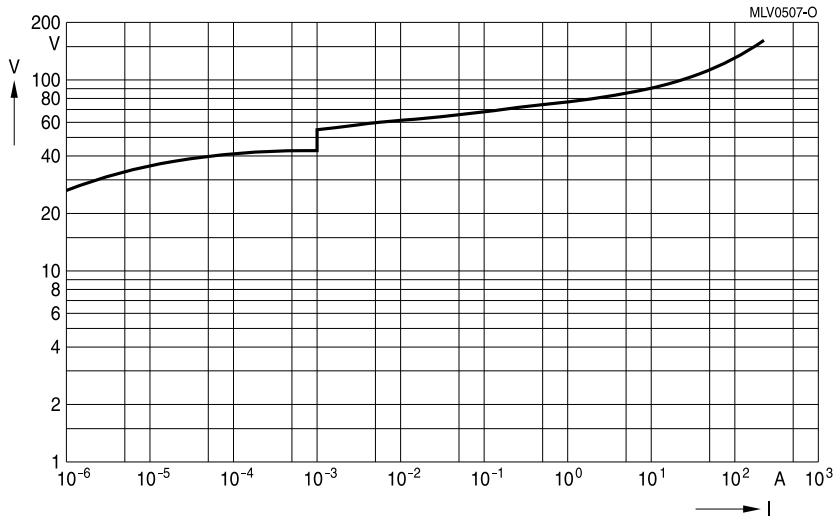

CT1206K30G

Multilayer varistors (MLVs)

Automotive E series

SMD

V/I characteristics for automotive standard series



CT1206K35G



CT1206K40G



**Multilayer varistors (MLVs)**

**Automotive E series**

**SMD**

**V/I characteristics for automotive standard series**



CT1210K14G



CT1210K17G

Multilayer varistors (MLVs)

Automotive E series

SMD

V/I characteristics for automotive standard series



CT1210K20G



CT1210K25G

**Multilayer varistors (MLVs)**

**Automotive E series**

**SMD**

**V/I characteristics for automotive standard series**



**CT1210K30G**



**CT1210K35G**

Multilayer varistors (MLVs)

Automotive E series

SMD

V/I characteristics for automotive standard series



CT1812K14G

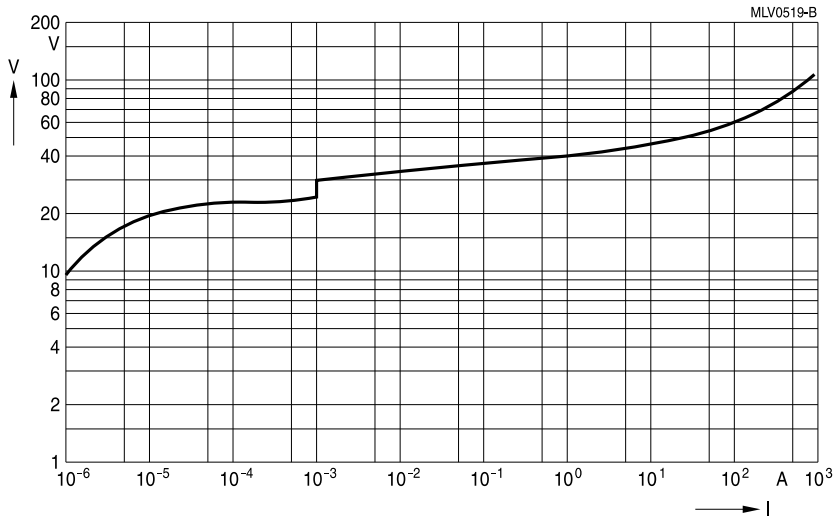

CT1812K17G

Multilayer varistors (MLVs)

Automotive E series

SMD

V/I characteristics for automotive standard series



CT1812K20G



CT1812K25G

**Multilayer varistors (MLVs)**

**Automotive E series**

**SMD**

**V/I characteristics for automotive standard series**



**CT1812K30G**



**CT1812K35G**

**Multilayer varistors (MLVs)**

**Automotive E series**

**SMD**

**V/I characteristics for automotive standard series**



CT2220K14G



CT2220K17G

**Multilayer varistors (MLVs)**

**Automotive E series**

**SMD**

**V/I characteristics for automotive standard series**



**CT2220K20G**

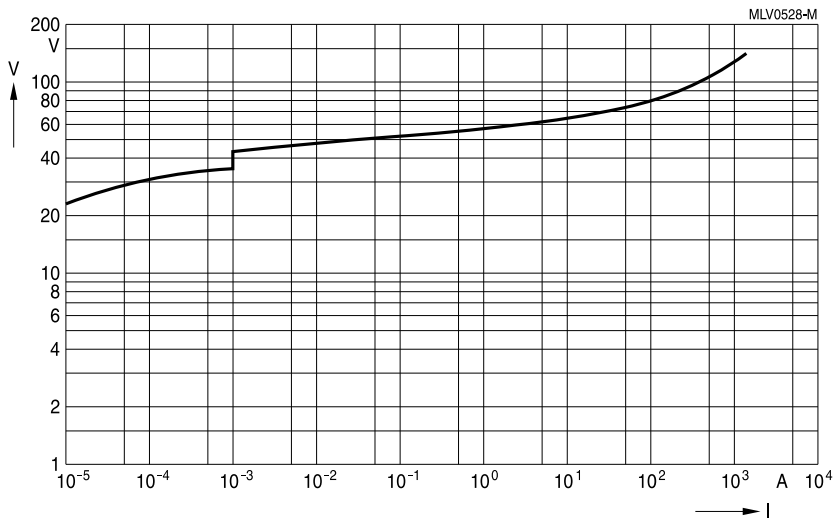

**CT2220K25G**



**Multilayer varistors (MLVs)**

**Automotive E series**

**SMD**

**V/I characteristics for automotive standard series**



CT2220K30G



CT2220K35G

**Multilayer varistors (MLVs)**

**Automotive E series**

**SMD**

**V/I characteristics for automotive standard series**



CT2220K40G

**Multilayer varistors (MLVs)**

**Automotive E series**

**SMD**

**V/I characteristics for automotive series with load dump/ jump-start protection**

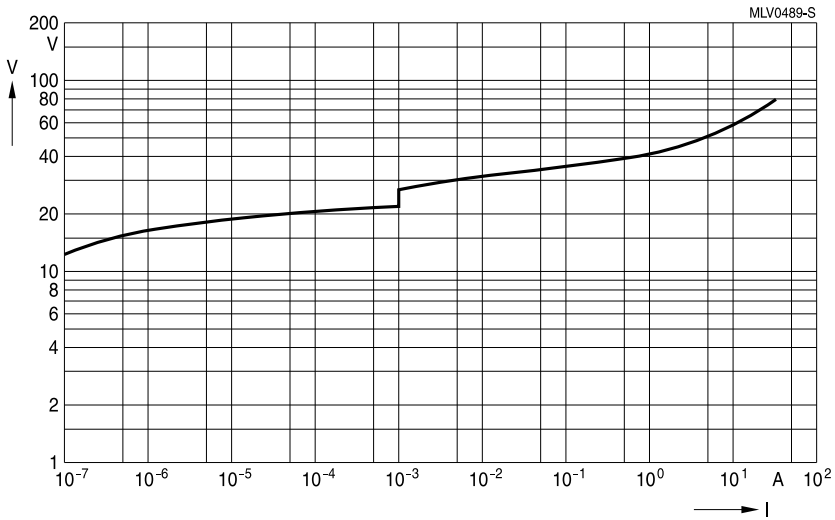

**CT0603S14BAUTOG**

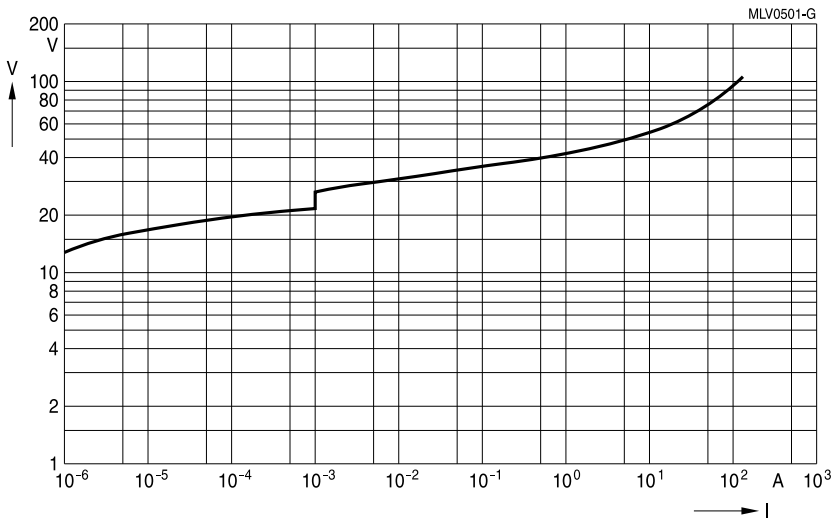

**CT0805S14BAUTOG**

Multilayer varistors (MLVs)

Automotive E series

SMD

V/I characteristics for automotive series with load dump/ jump-start protection

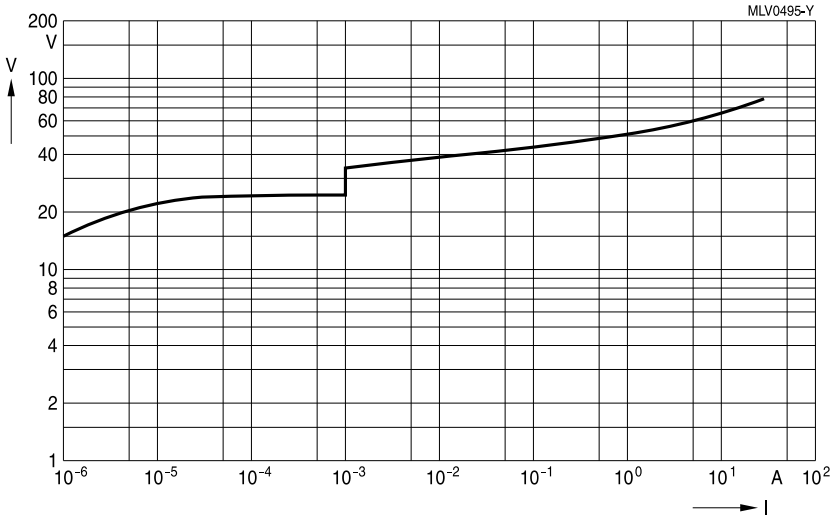

CT0805K17AUTOLCG

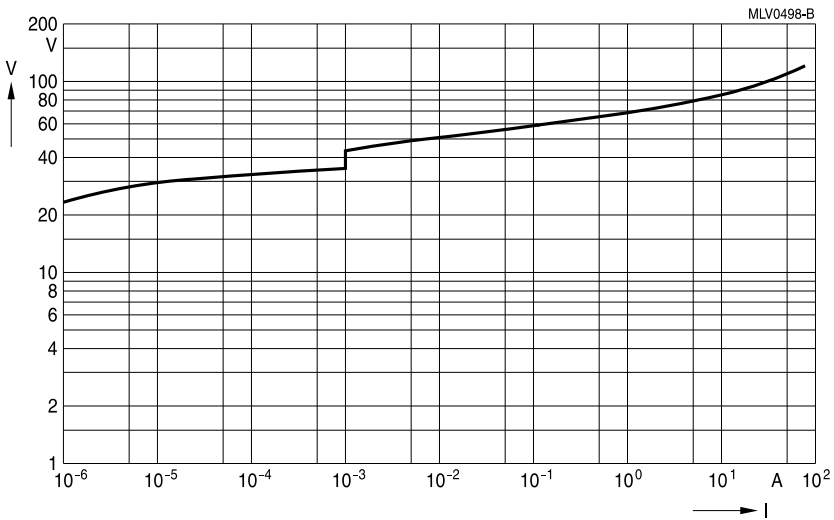

CT0805K25AUTOG

**Multilayer varistors (MLVs)**

**Automotive E series**

**SMD**

**V/I characteristics for automotive series with load dump/ jump-start protection**

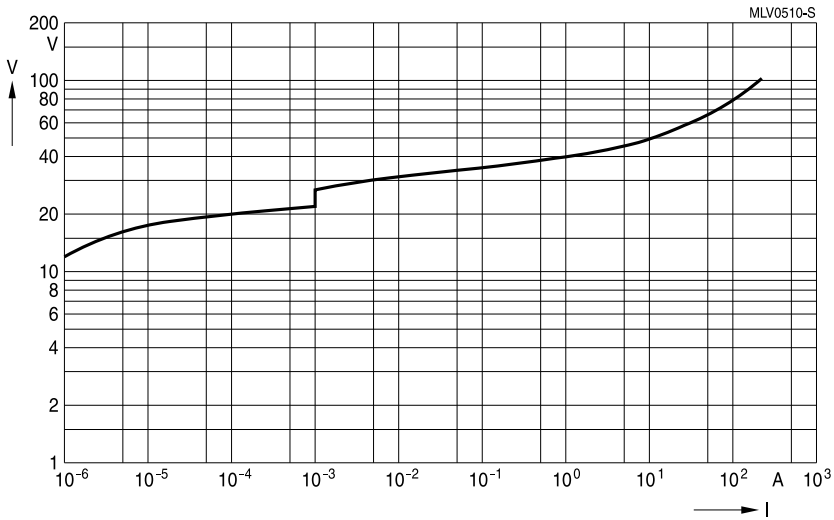

**CT1206S14BAUTOG**



**CT1206K20AUTOG**

**Multilayer varistors (MLVs)**

**Automotive E series**

**SMD**

**V/I characteristics for automotive series with load dump/ jump-start protection**

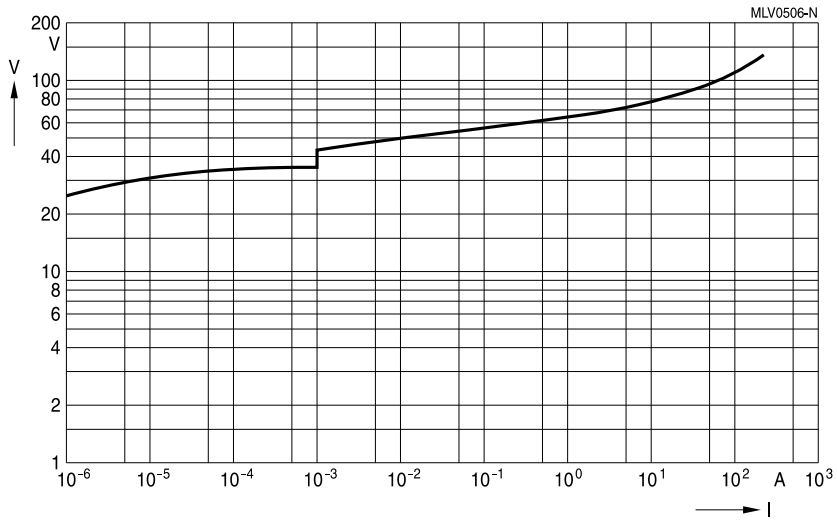

**CT1206K25AUTOG**

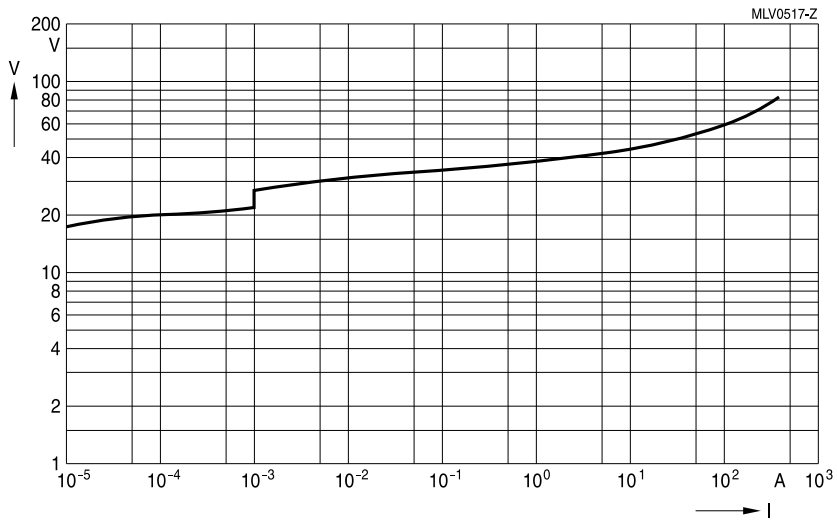

**CT1210S14BAUTOG**

**Multilayer varistors (MLVs)**

**Automotive E series**

**SMD**

**V/I characteristics for automotive series with load dump/ jump-start protection**



**CT1210K17AUTOG**



**CT1210K20AUTOG**

**Multilayer varistors (MLVs)**

**Automotive E series**

**SMD**

**V/I characteristics for automotive series with load dump/ jump-start protection**



**CT1210K25AUTOG**

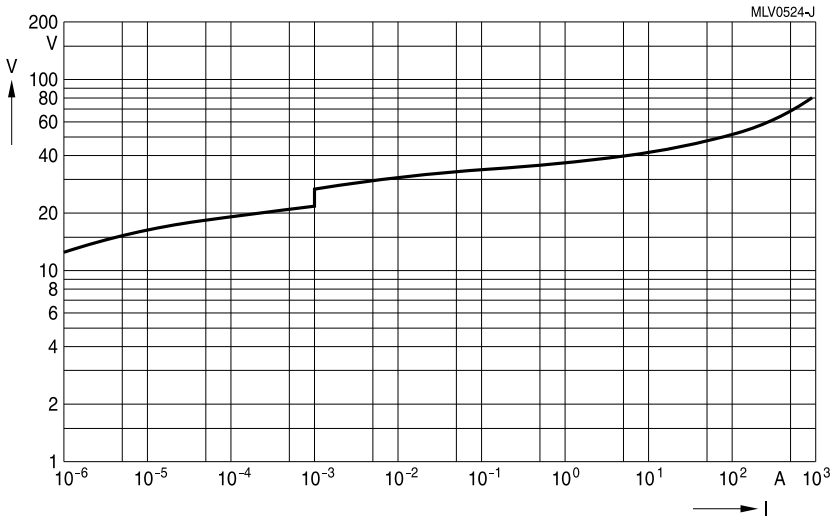

**CT1812S14BAUTOE2G2**

**CT1812S14BAUTOG**



**Multilayer varistors (MLVs)**

**Automotive E series**

**SMD**

**V/I characteristics for automotive series with load dump/ jump-start protection**



CT2220S14BAUTOE2G2



CT2220S14BAUTOG

**Multilayer varistors (MLVs)**

**Automotive E series**

**SMD**

**V/I characteristics for automotive series with load dump/ jump-start protection**



CT2220K30AUTOE2G2



CT2220K30AUTOG

**Multilayer varistors (MLVs)**

**Automotive E series**

**SMD**

**V/I characteristics for automotive series, array**

(Derating curve is not specified for CA05M2S10T100HG)

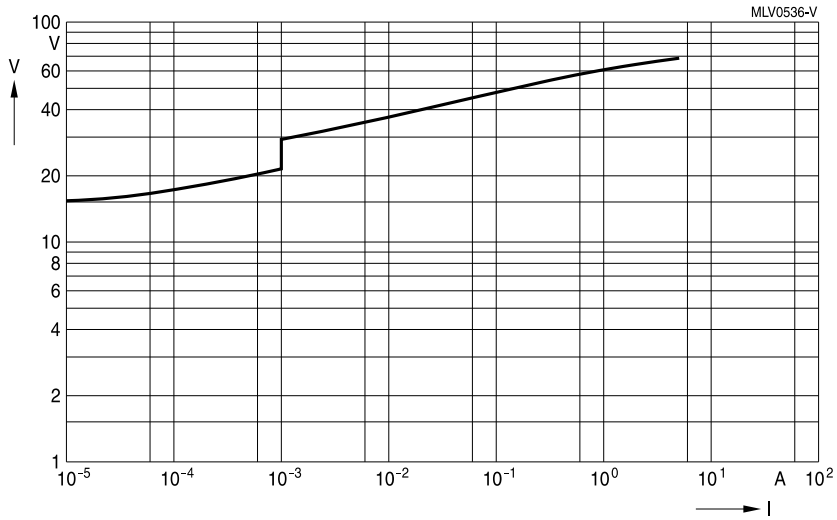

CA05M2S10T100HG, MCV array

**Multilayer varistors (MLVs)**

**Automotive E series**

**SMD**

**Derating curves for automotive standard series**

Maximum surge current  $I_{\text{surge,max}} = f(t_r, \text{pulse train})$

For explanation of the derating curves refer to "General technical information", chapter 2.7.1



CT0402L14G



CT0402S17AG

## Multilayer varistors (MLVs)

### Automotive E series

#### SMD

#### Derating curves for automotive standard series

Maximum surge current  $I_{\text{surge,max}} = f(t_r, \text{pulse train})$

For explanation of the derating curves refer to "General technical information", chapter 2.7.1



CT0603K14G ... K25G  
CT0603S17ALCG

CT0603K17LCG  
CT0603S17BCCG

CT0603S14BG  
CT0603S20ACCG



CT0603L25HTCCG

CT0603S14AHSG

CT0603L25HSG

**Multilayer varistors (MLVs)**

**Automotive E series**

**SMD**

**Derating curves for automotive standard series**

Maximum surge current  $I_{\text{surge,max}} = f(t_r, \text{pulse train})$

For explanation of the derating curves refer to "General technical information", chapter 2.7.1



CT0805K11G ... K17G



CT0805K20G ... K35G

CT0805S20ACC2G2

## Multilayer varistors (MLVs)

### Automotive E series

#### SMD

#### Derating curves for automotive standard series

Maximum surge current  $I_{\text{surge,max}} = f(t_r, \text{pulse train})$

For explanation of the derating curves refer to "General technical information", chapter 2.7.1



CT1206K14G ... K30G



CT1206K35G ... K40G

**Multilayer varistors (MLVs)**

**Automotive E series**

**SMD**

**Derating curves for automotive standard series**

Maximum surge current  $I_{\text{surge,max}} = f(t_r, \text{pulse train})$

For explanation of the derating curves refer to "General technical information", chapter 2.7.1



CT1210K14G ... K20G



CT1210K25G ... K30G



**Multilayer varistors (MLVs)**

**Automotive E series**

**SMD**

**Derating curves for automotive standard series**

Maximum surge current  $I_{\text{surge,max}} = f(t_r, \text{pulse train})$

For explanation of the derating curves refer to "General technical information", chapter 2.7.1



CT1210K35G



CT1812K14G ... K30G

**Multilayer varistors (MLVs)**

**Automotive E series**

**SMD**

**Derating curves for automotive standard series**

Maximum surge current  $I_{\text{surge,max}} = f(t_r, \text{pulse train})$

For explanation of the derating curves refer to "General technical information", chapter 2.7.1



CT1812K35G



CT2220K14G ... K30G

**Multilayer varistors (MLVs)**

**Automotive E series**

**SMD**

**Derating curves for automotive standard series**

Maximum surge current  $I_{\text{surge,max}} = f(t_r, \text{pulse train})$

For explanation of the derating curves refer to "General technical information", chapter 2.7.1



CT2220K35G ... K40G

**Multilayer varistors (MLVs)**

**Automotive E series**

**SMD**

**Derating curves for automotive series with load dump/ jump-start protection**

Maximum surge current  $I_{\text{surge,max}} = f(t_r, \text{pulse train})$

For explanation of the derating curves refer to "General technical information", chapter 2.7.1



CT0603S14BAUTOG



CT0805K17AUTOLCG

CT0805K25AUTOG

**Multilayer varistors (MLVs)**

**Automotive E series**

**SMD**

**Derating curves for automotive series with load dump/ jump-start protection**

Maximum surge current  $I_{\text{surge,max}} = f(t_r, \text{pulse train})$

For explanation of the derating curves refer to "General technical information", chapter 2.7.1



CT0805S14BAUTOG



CT1206K20AUTOG

CT1206K25AUTOG

CT1206S14BAUTOG

**Multilayer varistors (MLVs)**

**Automotive E series**

**SMD**

**Derating curves for automotive series with load dump/ jump-start protection**

Maximum surge current  $I_{\text{surge,max}} = f(t_r, \text{pulse train})$

For explanation of the derating curves refer to "General technical information", chapter 2.7.1



CT1210K17AUTOG

CT1210K20AUTOG

CT1210S14BAUTOG



CT1210K25AUTOG

**Multilayer varistors (MLVs)**

**Automotive E series**

**SMD**

**Derating curves for automotive series with load dump/ jump-start protection**

Maximum surge current  $I_{\text{surge,max}} = f(t_r, \text{pulse train})$

For explanation of the derating curves refer to "General technical information", chapter 2.7.1

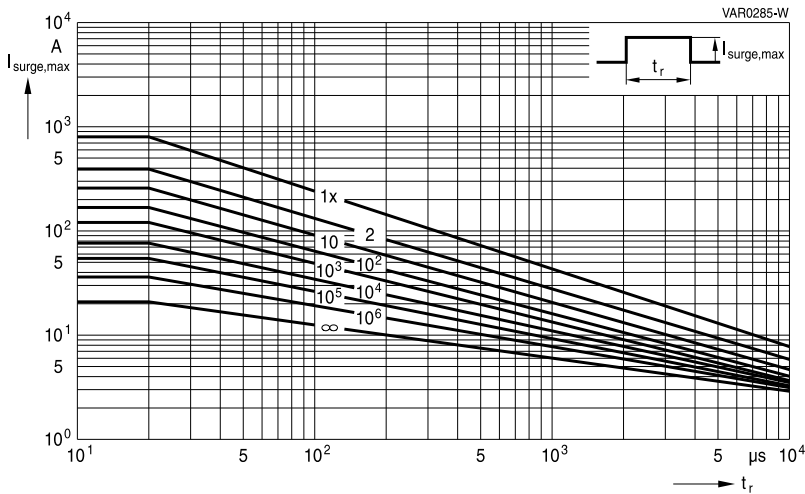

CT1812S14BAUTOE2G2

CT1812S14BAUTOG

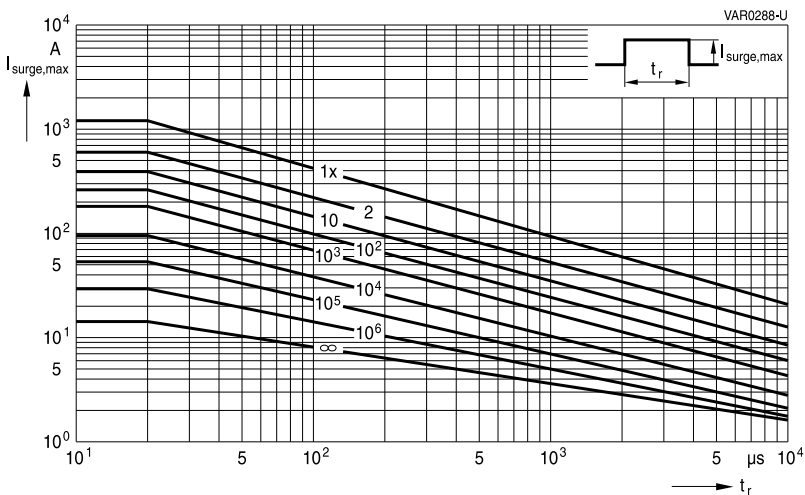

CT2220K30AUTOE2G2

CT2220S14BAUTOE2G2

CT2220K30AUTOG

CT2220S14BAUTOG

## Multilayer varistors (MLVs)

### Automotive E series

#### SMD

#### Taping and packing

#### 1 Taping and packing for SMD components

#### 1.1 Blister tape (taping to IEC 60286-3)



KKE0053-C-E

#### Dimensions in mm

	8-mm tape					12-mm tape		Tolerance
	Case size (inch/mm)					Case size (inch/mm)		
			0508/ 1220	0612/ 1632	1012/ 2532			
	0603/ 1608	0506/ 1216	0805/ 2012	1206/ 3216	1210/ 3225	1812/ 4532	2220/ 5750	
A <sub>0</sub>	0.9 ±0.10	1.50	1.50	1.80	2.80	3.50	5.10	±0.20
B <sub>0</sub>	1.75 ±0.10	1.80	2.30	3.40	3.50	4.80	6.00	±0.20
K <sub>0</sub>	1.0	0.80	1.80			3.40		max.
T	0.30					0.30		max.
T <sub>2</sub>	1.3	1.20	2.50			3.90		max.
D <sub>0</sub>	1.50					1.50		+0.10/-0
D <sub>1</sub>	0.3					1.50		min.
P <sub>0</sub>	4.00					4.00		±0.10 <sup>1)</sup>
P <sub>2</sub>	2.00					2.00		±0.05
P <sub>1</sub>	4.00					8.00		±0.10
W	8.00					12.00		±0.30
E	1.75					1.75		±0.10
F	3.50					5.50		±0.05
G	0.75					0.75		min.

1) ≤±0.2 mm over 10 sprocket holes.



## Multilayer varistors (MLVs)

### Automotive E series

### SMD

#### Part orientation in tape pocket for blister tape

For discrete chip, EIA case sizes 0603, 0805, 1206, 1210, 1812 and 2220



For array, EIA case size 0612



For arrays, EIA case sizes 0506 and 1012



For filter array, EIA case size 0508



#### Additional taping information

Reel material	Polystyrol (PS)
Tape material	Polystyrol (PS) or Polycarbonat (PC) or PVC
Tape break force	min. 10 N
Top cover tape strength	min. 10 N
Top cover tape peel force	0.1 to 1.0 N for 8-mm tape and 0.1 to 1.3 N for 12-mm tape at a peel speed of 300 mm/min
Tape peel angle	Angle between top cover tape and the direction of feed during peel off: 165° to 180°
Cavity play	Each part rests in the cavity so that the angle between the part and cavity center line is no more than 20°

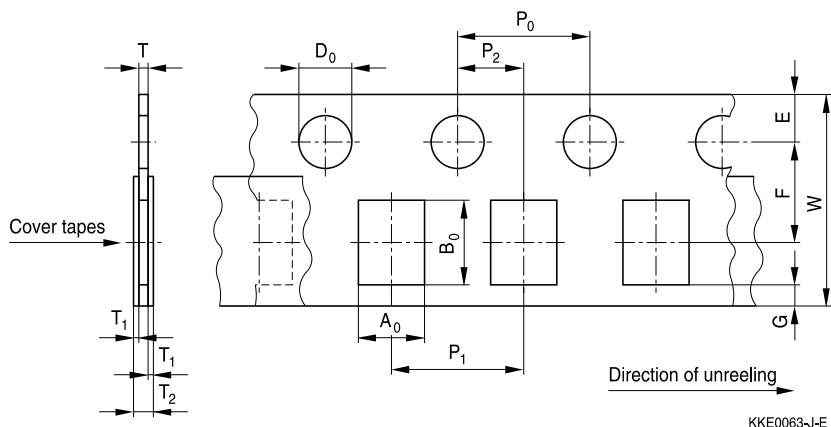
**Multilayer varistors (MLVs)**
**Automotive E series**
**SMD**
**1.2 Cardboard tape (taping to IEC 60286-3)**

**Dimensions in mm**

	8-mm tape						Tolerance
	Case size (inch/mm)					Case size (inch/mm)	
	0201/0603	0402/1005	0405/1012	0603/1608	1003/2508	0508/1220	
A <sub>0</sub>	0.38 ±0.05	0.60	1.05	0.95	1.00	1.60	±0.20
B <sub>0</sub>	0.68 ±0.05	1.15	1.60	1.80	2.85	2.40	±0.20
T	0.42 ±0.02	0.60	0.75	0.95	0.95	0.95	max.
T <sub>2</sub>	0.4 min.	0.70	0.90	1.10	1.10	1.10	max.
D <sub>0</sub>	1.50 ±0.1	1.50				1.50	+0.10/-0
P <sub>0</sub>	4.00						±0.10 <sup>2)</sup>
P <sub>2</sub>	2.00						±0.05
P <sub>1</sub>	2.00 ±0.05	2.00	4.00	4.00	4.00	4.00	±0.10
W	8.00						±0.30
E	1.75						±0.10
F	3.50						±0.05
G	0.75						min.

2) ≤0.2 mm over 10 sprocket holes.

## Multilayer varistors (MLVs)

### Automotive E series

### SMD

#### Part orientation in tape pocket for cardboard tape

For discrete chip, EIA case sizes 0201, 0402, 0603 and 1003

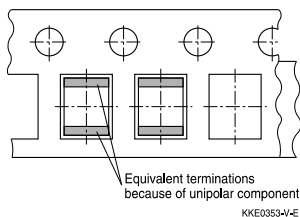

For array, EIA case size 0405

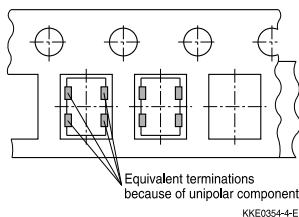

For array, EIA case size 0508



For filter array, EIA case size 0405

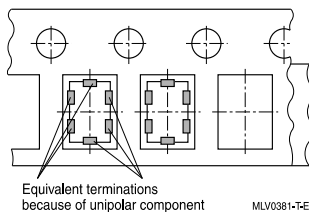

#### Additional taping information

Reel material	Polystyrol (PS)
Tape material	Cardboard
Tape break force	min. 10 N
Top cover tape strength	min. 10 N
Top cover tape peel force	0.1 to 1.0 N at a peel speed of 300 mm/min
Tape peel angle	Angle between top cover tape and the direction of feed during peel off: 165° to 180°
Cavity play	Each part rests in the cavity so that the angle between the part and cavity center line is no more than 20°

## Multilayer varistors (MLVs)

### Automotive E series

#### SMD

### 1.3 Reel packing



#### Dimensions in mm

	8-mm tape		12-mm tape	
	180-mm reel	330-mm reel	180-mm reel	330-mm reel
A	180 +0/-3	330 +0/-2.0	180 +0/-3	330 +0/-2.0
W <sub>1</sub>	8.4 +1.5/-0	8.4 +1.5/-0	12.4 +1.5/-0	12.4 +1.5/-0
W <sub>2</sub>	14.4 max.	14.4 max.	18.4 max.	18.4 max.

#### Leader, trailer

Trailer (tape end)

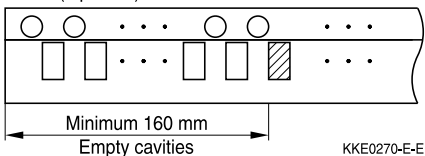

Leader

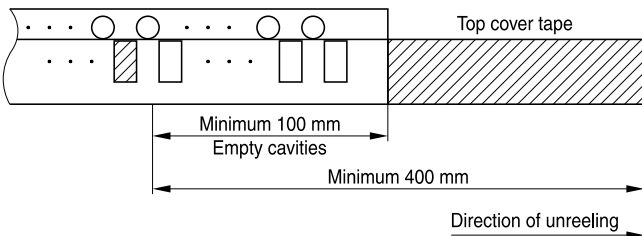

**Multilayer varistors (MLVs)**
**Automotive E series**
SMD
**1.4 Packing units for discrete chip and array chip**

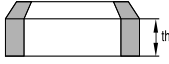
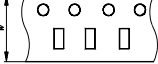
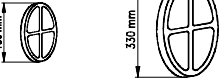
Case size inch/mm	 Chip thickness th				
		Cardboard tape W	Blister tape W	∅ 180-mm reel pcs.	∅ 330-mm reel pcs.
0201/0603	0.33 mm	8 mm	–	15000	–
0402/1005	0.6 mm	8 mm	–	10000	50000
0405/1012	0.7 mm	8 mm	–	5000	–
0506/1216	0.5 mm	–	8 mm	4000	–
0508/1220	0.9 mm	8 mm	8 mm	4000	–
0603/1608	0.9 mm	8 mm	8 mm	4000	16000
0612/1632	0.7 mm	–	8 mm	3000	–
0805/2012	0.7 mm	–	8 mm	3000	–
	0.9 mm	–	8 mm	3000	12000
	1.3 mm	–	8 mm	3000	12000
1003/2508	0.9 mm	8 mm	–	4000	–
1012/2532	1.0 mm	–	8 mm	2000	–
1206/3216	0.9 mm	–	8 mm	3000	–
	1.3 mm	–	8 mm	3000	12000
	1.4 mm	–	8 mm	2000	8000
	1.6 mm	–	8 mm	2000	8000
1210/3225	0.9 mm	–	8 mm	3000	–
	1.3 mm	–	8 mm	3000	12000
	1.4 mm	–	8 mm	2000	8000
	1.6 mm	–	8 mm	2000	8000
1812/4532	1.3 mm	–	12 mm	1500	–
	1.4 mm	–	12 mm	1000	–
	1.6 mm	–	12 mm	1000	4000
	2.0 mm	–	12 mm	–	3000
	2.3 mm	–	12 mm	–	3000
2220/5750	1.3 mm	–	12 mm	1500	–
	1.4 mm	–	12 mm	1000	–
	1.6 mm	–	12 mm	1000	–
	2.0 mm	–	12 mm	–	3000
	2.3 mm	–	12 mm	–	3000
	2.7 mm	–	12 mm	600	–
	3.0 mm	–	12 mm	600	–

**Multilayer varistors (MLVs)****Automotive E series****SMD****2 Delivery mode for leaded SHCV varistors**

Standard delivery mode for SHCV types is bulk. Alternative taping modes (AMMO pack or taped on reel) are available upon request.

Packing units for:

Type	Pieces
SR6	2000
SR1 / SR2	1000

For types not listed in this data book please contact EPCOS.

## Multilayer varistors (MLVs)

### Automotive E series

#### SMD

### Soldering directions

#### 1 Terminations and soldering methods

##### 1.1 Nickel barrier termination

The nickel barrier layer of the silver/nickel/tin termination prevents leaching of the silver base metallization layer. This allows great flexibility in the selection of soldering parameters. The tin prevents the nickel layer from oxidizing and thus ensures better wetting by the solder. The nickel barrier termination is suitable for lead-free soldering, as well as for other commonly-used soldering methods.

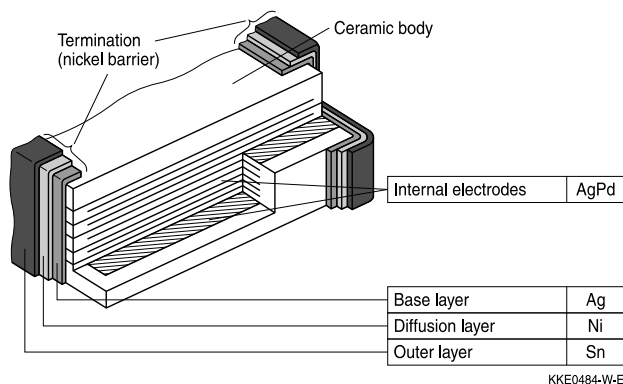

Multilayer CTVS: Structure of nickel barrier termination

##### 1.2 Silver-platinum termination

Silver-platinum terminations are mainly used for the large EIA case sizes 1812 and 2220. The silver-platinum termination is approved for reflow soldering, SnPb soldering and lead-free soldering with a silver containing solder paste. In case of SnPb soldering, a solder paste Sn62Pb36Ag2 is recommended. For lead-free reflow soldering, a solder paste SAC, e.g. Sn95.5Ag3.8Cu0.7, is recommended.



Multilayer varistor: Structure of silver-platinum termination

## Multilayer varistors (MLVs)

### Automotive E series

#### SMD

#### 1.3 Silver-palladium termination

Silver-palladium terminations are designed for the use of conductive adhesives. Lead-free reflow soldering does not form a proper solder joint. In general reflow or wave soldering is not recommended.

#### 1.4 Tinned iron wire

All SHCV types with tinned terminations are suitable for lead-free and SnPb soldering.



## Multilayer varistors (MLVs)

### Automotive E series

#### SMD

## 2 Recommended soldering temperature profiles

### 2.1 Reflow soldering temperature profile

Temperature ranges for reflow soldering acc. to IEC 60068-2-58 recommendations.



Profile feature		Sn-Pb eutectic assembly	Pb-free assembly
Preheat and soak			
- Temperature min	$T_{smin}$	100 °C	150 °C
- Temperature max	$T_{smax}$	150 °C	200 °C
- Time	$t_{smin}$ to $t_{smax}$	60 ... 120 s	60 ... 120 s
Average ramp-up rate	$T_{smax}$ to $T_p$	3 °C/ s max.	3 °C/ s max.
Liquidous temperature	$T_L$	183 °C	217 °C
Time at liquidous	$t_L$	40 ... 150 s	40 ... 150 s
Peak package body temperature	$T_p$	215 °C ... 260 °C <sup>1)</sup>	235 °C ... 260 °C
Time above ( $T_p - 5$ °C)	$t_p$	10 ... 40 s	10 ... 40 s
Average ramp-down rate	$T_p$ to $T_{smax}$	6 °C/ s max.	6 °C/ s max.
Time 25 °C to peak temperature		max. 8 minutes	max. 8 minutes

1) Depending on package thickness.

**Notes:** All temperatures refer to topside of the package, measured on the package body surface.

Number of reflow cycles: 3

Iron soldering should be avoided, hot air methods are recommended for repair purposes.

## Multilayer varistors (MLVs)

### Automotive E series

#### SMD

### 2.2 Wave soldering temperature profile

Temperature characteristics at component terminal with dual-wave soldering

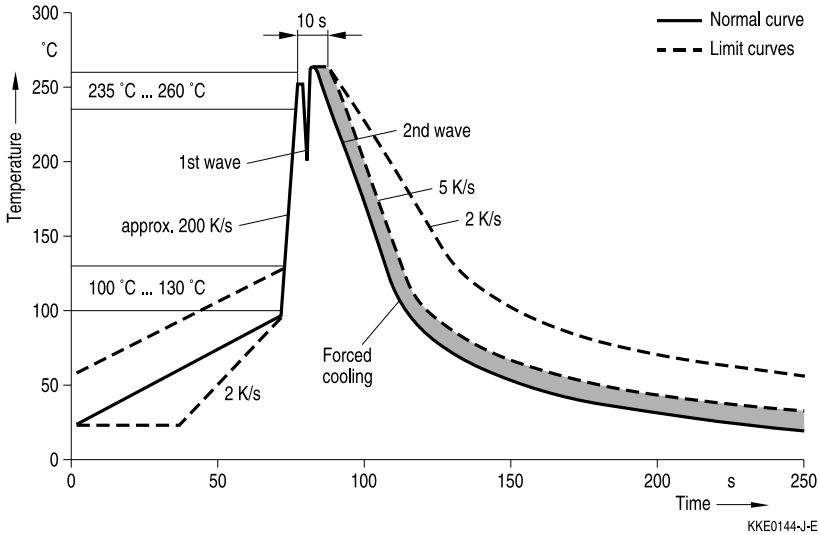

## 3 Solder joint profiles / solder quantity

### 3.1 Nickel barrier termination

If the meniscus height is too low, that means the solder quantity is too low, the solder joint may break, i.e. the component becomes detached from the joint. This problem is sometimes interpreted as leaching of the external terminations.

If the solder meniscus is too high, i.e. the solder quantity is too large, the vise effect may occur. As the solder cools down, the solder contracts in the direction of the component. If there is too much solder on the component, it has no leeway to evade the stress and may break, as in a vise.

The figures below show good and poor solder joints for dual-wave and infrared soldering.

**Multilayer varistors (MLVs)**

**Automotive E series**

**SMD**

**3.1.1 Solder joint profiles for nickel barrier termination - dual-wave soldering**

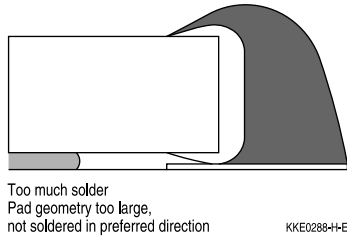

Good and poor solder joints caused by amount of solder in dual-wave soldering.

**3.1.2 Solder joint profiles for nickel barrier termination / silver-platinum termination - reflow soldering**

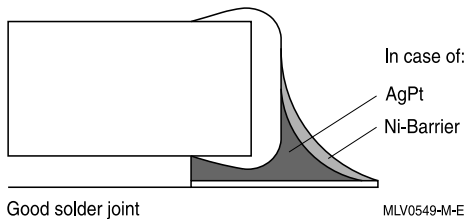
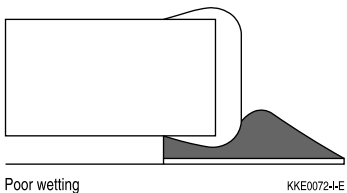
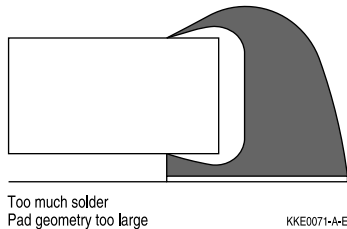
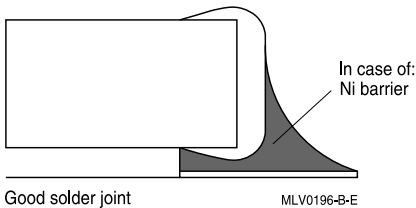

Good and poor solder joints caused by amount of solder in reflow soldering.

**Multilayer varistors (MLVs)**
**Automotive E series**
**SMD**
**4 Solderability tests**

Test	Standard	Test conditions Sn-Pb soldering	Test conditions Pb-free soldering	Criteria/ test results
Wettability	IEC 60068-2-58	Immersion in 60/40 SnPb solder using non-activated flux at 215 ±3 °C for 3 ±0.3 s	Immersion in Sn96.5Ag3.0Cu0.5 solder using non- or low activated flux at 245 ±5 °C for 3 ±0.3 s	Covering of 95% of end termination, checked by visual inspection
Leaching resistance	IEC 60068-2-58	Immersion in 60/40 SnPb solder using mildly activated flux without preheating at 260 ±5 °C for 10 ±1 s	Immersion in Sn96.5Ag3.0Cu0.5 solder using non- or low activated flux without preheating at 255 ±5 °C for 10 ±1 s	No leaching of contacts
Thermal shock (solder shock)		Dip soldering at 300 °C/5 s	Dip soldering at 300 °C/5 s	No deterioration of electrical parameters. Capacitance change: $ \Delta C/C_0  \leq 15\%$
Tests of resistance to soldering heat for SMDs	IEC 60068-2-58	Immersion in 60/40 SnPb for 10 s at 260 °C	Immersion in Sn96.5Ag3.0Cu0.5 for 10 s at 260 °C	Change of varistor voltage: $ \Delta V/V (1 \text{ mA})  \leq 5\%$
Tests of resistance to soldering heat for radial leaded components (SHCV)	IEC 60068-2-20	Immersion of leads in 60/40 SnPb for 10 s at 260 °C	Immersion of leads in Sn96.5Ag3.0Cu0.5 for 10 s at 260 °C	Change of varistor voltage: $ \Delta V/V (1 \text{ mA})  \leq 5\%$ Change of capacitance X7R: $\leq -5/+10\%$

## Multilayer varistors (MLVs)

### Automotive E series

#### SMD

#### Note:

#### Leaching of the termination

Effective area at the termination might be lost if the soldering temperature and/or immersion time are not kept within the recommended conditions. Leaching of the outer electrode should not exceed 25% of the chip end area (full length of the edge A-B-C-D) and 25% of the length A-B, shown below as mounted on substrate.



As a single chip



As mounted on substrate

## 5 Notes for proper soldering

### 5.1 Preheating and cooling

- According to IEC 60068-2-58. Please refer to section 2 of this chapter.

### 5.2 Repair/ rework

Manual soldering with a soldering iron must be avoided, hot-air methods are recommended for rework purposes.

### 5.3 Cleaning

All environmentally compatible agents are suitable for cleaning. Select the appropriate cleaning solution according to the type of flux used. The temperature difference between the components and cleaning liquid must not be greater than 100 °C. Ultrasonic cleaning should be carried out with the utmost caution. Too high ultrasonic power can impair the adhesive strength of the metalized surfaces.

### 5.4 Solder paste printing (reflow soldering)

An excessive application of solder paste results in too high a solder fillet, thus making the chip more susceptible to mechanical and thermal stress. Too little solder paste reduces the adhesive strength on the outer electrodes and thus weakens the bonding to the PCB. The solder should be applied smoothly to the end surface.

## Multilayer varistors (MLVs)

### Automotive E series

#### SMD

#### 5.5 Selection of flux

Used flux should have less than or equal to 0.1 wt % of halogenated content, since flux residue after soldering could lead to corrosion of the termination and/or increased leakage current on the surface of the component. Strong acidic flux must not be used. The amount of flux applied should be carefully controlled, since an excess may generate flux gas, which in turn is detrimental to solderability.

#### 5.6 Storage of CTVSs

Solderability is guaranteed for one year from date of delivery for multilayer varistors, CeraDiodes and ESD/EMI filters (half a year for chips with AgPt terminations) and two years for SHCV components, provided that components are stored in their original packages.

Storage temperature:  $-25\text{ }^{\circ}\text{C}$  to  $+45\text{ }^{\circ}\text{C}$

Relative humidity:  $\leq 75\%$  annual average,  $\leq 95\%$  on 30 days a year

The solderability of the external electrodes may deteriorate if SMDs and leaded components are stored where they are exposed to high humidity, dust or harmful gas (hydrogen chloride, sulfuric acid gas or hydrogen sulfide).

Do not store SMDs and leaded components where they are exposed to heat or direct sunlight. Otherwise the packing material may be deformed or SMDs/ leaded components may stick together, causing problems during mounting.

After opening the factory seals, such as polyvinyl-sealed packages, it is recommended to use the SMDs or leaded components as soon as possible.

Solder CTVS components after shipment from TDK Electronics within the time specified:

CTVS with Ni barrier termination: 12 months

CTVS with AgPt termination: 6 months

SHCV (leaded components): 24 months

#### 5.7 Placement of components on circuit board

Especially in the case of dual-wave soldering, it is of advantage to place the components on the board before soldering in that way that their two terminals do not enter the solder bath at different times.

Ideally, both terminals should be wetted simultaneously.

## Multilayer varistors (MLVs)

### Automotive E series

#### SMD

#### 5.8 Soldering cautions

An excessively long soldering time or high soldering temperature results in leaching of the outer electrodes, causing poor adhesion and a change of electrical properties of the varistor due to the loss of contact between electrodes and termination.

Keep the recommended down-cooling rate.

#### 5.9 Standards

CECC 00802

IEC 60068-2-58

IEC 60068-2-20

## Multilayer varistors (MLVs)

### Automotive E series

#### SMD

#### Symbols and terms

#### For ceramic transient voltage suppressors (CTVS)

Symbol	Term
$C_{line,max}$	Maximum capacitance per line
$C_{line,min}$	Minimum capacitance per line
$C_{line,typ}$	Typical capacitance per line
$C_{max}$	Maximum capacitance
$C_{min}$	Minimum capacitance
$C_{nom}$	Nominal capacitance
$\Delta C_{nom}$	Tolerance of nominal capacitance
$C_{typ}$	Typical capacitance
$f_{cut-off,max}$	Maximum cut-off frequency
$f_{cut-off,min}$	Minimum cut-off frequency
$f_{cut-off,typ}$	Typical cut-off frequency
$f_{res,typ}$	Typical resonance frequency
$I$	Current
$I_{clamp}$	Clamping current
$I_{leak}$	Leakage current
$I_{leak,max}$	Maximum leakage current
$I_{leak,typ}$	Typical leakage current
$I_{PP}$	Peak pulse current
$I_{surge,max}$	Maximum surge current (also termed peak current)
LCT	Lower category temperature
$L_{typ}$	Typical inductance
$P_{diss,max}$	Maximum power dissipation
$P_{PP}$	Peak pulse power
$R_{ins}$	Insulation resistance
$R_{min}$	Minimum resistance
$R_S$	Resistance per line
$R_{S,typ}$	Typical resistance per line
$T_A$	Ambient temperature
$T_{op}$	Operating temperature
$T_{op,max}$	Maximum operating temperature
$T_{stg}$	Storage temperature



**Multilayer varistors (MLVs)**
**Automotive E series**
SMD

Symbol	Term
$t_r$	Duration of equivalent rectangular wave
$t_{resp}$	Response time
$t_{resp,max}$	Maximum response time
UCT	Upper category temperature
V	Voltage
$V_{BR,min}$	Minimum breakdown voltage
$V_{clamp,max}$	Maximum clamping voltage
$V_{DC,max}$	Maximum DC operating voltage (also termed working voltage)
$V_{ESD,air}$	Air discharge ESD capability
$V_{ESD,contact}$	Contact discharge ESD capability
$V_{jump}$	Maximum jump-start voltage
$V_{RMS,max}$	Maximum AC operating voltage, root-mean-square value
$V_V$	Varistor voltage (also termed breakdown voltage)
$V_{LD}$	Maximum load dump voltage
$V_{leak}$	Measurement voltage for leakage current
$V_{V,min}$	Minimum varistor voltage
$V_{V,max}$	Maximum varistor voltage
$\Delta V_V$	Tolerance of varistor voltage
$W_{LD}$	Maximum load dump energy
$W_{max}$	Maximum energy absorption (also termed transient energy)
$\alpha_{typ}$	Typical insertion loss
$\tan \delta$	Dissipation factor
$e$	Lead spacing
$\ll * \gg$	Maximum possible application conditions

All dimensions are given in mm.

The commas used in numerical values denote decimal points.

## Multilayer varistors (MLVs)

### Automotive E series

#### SMD

### Cautions and warnings

#### General

Some parts of this publication contain statements about the suitability of our ceramic transient voltage suppressor (CTVS) components (multilayer varistors (MLVs)), CeraDiodes, ESD/EMI filters, leaded transient voltage/ RFI suppressors (SHCV types)) for certain areas of application, including recommendations about incorporation/design-in of these products into customer applications. The statements are based on our knowledge of typical requirements often made of our CTVS devices in the particular areas. We nevertheless expressly point out that such statements cannot be regarded as binding statements about the suitability of our CTVS components for a particular customer application. As a rule, EPCOS is either unfamiliar with individual customer applications or less familiar with them than the customers themselves. For these reasons, it is always incumbent on the customer to check and decide whether the CTVS devices with the properties described in the product specification are suitable for use in a particular customer application.

- Do not use EPCOS CTVS components for purposes not identified in our specifications, application notes and data books.
- Ensure the suitability of a CTVS in particular by testing it for reliability during design-in. Always evaluate a CTVS component under worst-case conditions.
- Pay special attention to the reliability of CTVS devices intended for use in safety-critical applications (e.g. medical equipment, automotive, spacecraft, nuclear power plant).

#### Design notes

- Always connect a CTVS in parallel with the electronic circuit to be protected.
- Consider maximum rated power dissipation if a CTVS has insufficient time to cool down between a number of pulses occurring within a specified isolated time period. Ensure that electrical characteristics do not degrade.
- Consider derating at higher operating temperatures. Choose the highest voltage class compatible with derating at higher temperatures.
- Surge currents beyond specified values will puncture a CTVS. In extreme cases a CTVS will burst.
- If steep surge current edges are to be expected, make sure your design is as low-inductance as possible.
- In some cases the malfunctioning of passive electronic components or failure before the end of their service life cannot be completely ruled out in the current state of the art, even if they are operated as specified. In applications requiring a very high level of operational safety and especially when the malfunction or failure of a passive electronic component could endanger human life or health (e.g. in accident prevention, life-saving systems, or automotive battery line applications such as clamp 30), ensure by suitable design of the application or other measures (e.g. installation of protective circuitry or redundancy) that no injury or damage is sustained by third parties in the event of such a malfunction or failure. Only use CTVS components from the automotive series in safety-relevant applications.

## Multilayer varistors (MLVs)

### Automotive E series

#### SMD

- Specified values only apply to CTVS components that have not been subject to prior electrical, mechanical or thermal damage. The use of CTVS devices in line-to-ground applications is therefore not advisable, and it is only allowed together with safety countermeasures like thermal fuses.

#### Storage

- Only store CTVS in their original packaging. Do not open the package prior to processing.
- Storage conditions in original packaging: temperature  $-25$  to  $+45^{\circ}\text{C}$ , relative humidity  $\leq 75\%$  annual average, maximum 95%, dew precipitation is inadmissible.
- Do not store CTVS devices where they are exposed to heat or direct sunlight. Otherwise the packaging material may be deformed or CTVS may stick together, causing problems during mounting.
- Avoid contamination of the CTVS surface during storage, handling and processing.
- Avoid storing CTVS devices in harmful environments where they are exposed to corrosive gases for example ( $\text{SO}_x$ , Cl).
- Use CTVS as soon as possible after opening factory seals such as polyvinyl-sealed packages.
- Solder CTVS components after shipment from EPCOS within the time specified:
  - CTVS with Ni barrier termination, 12 months
  - CTVS with AgPt termination, 6 months
  - SHCV, 24 months

#### Handling

- Do not drop CTVS components and allow them to be chipped.
- Do not touch CTVS with your bare hands - gloves are recommended.
- Avoid contamination of the CTVS surface during handling.
- Washing processes may damage the product due to the possible static or cyclic mechanical loads (e.g. ultrasonic cleaning). They may cause cracks to develop on the product and its parts, which might lead to reduced reliability or lifetime.

#### Mounting

- When CTVS devices are encapsulated with sealing material or overmolded with plastic material, electrical characteristics might be degraded and the life time reduced.
- Make sure an electrode is not scratched before, during or after the mounting process.
- Make sure contacts and housings used for assembly with CTVS components are clean before mounting.
- The surface temperature of an operating CTVS can be higher. Ensure that adjacent components are placed at a sufficient distance from a CTVS to allow proper cooling.
- Avoid contamination of the CTVS surface during processing.

## Multilayer varistors (MLVs)

### Automotive E series

#### SMD

#### Soldering

- Complete removal of flux is recommended to avoid surface contamination that can result in an instable and/or high leakage current.
- Use resin-type or non-activated flux.
- Bear in mind that insufficient preheating may cause ceramic cracks.
- Rapid cooling by dipping in solvent is not recommended, otherwise a component may crack.

#### Operation

- Use CTVS only within the specified operating temperature range.
- Use CTVS only within specified voltage and current ranges.
- Environmental conditions must not harm a CTVS. Only use them in normal atmospheric conditions. Reducing the atmosphere (e.g. hydrogen or nitrogen atmosphere) is prohibited.
- Prevent a CTVS from contacting liquids and solvents. Make sure that no water enters a CTVS (e.g. through plug terminals).
- Avoid dewing and condensation.
- EPCOS CTVS components are mainly designed for encased applications. Under all circumstances avoid exposure to:
  - direct sunlight
  - rain or condensation
  - steam, saline spray
  - corrosive gases
  - atmosphere with reduced oxygen content
- EPCOS CTVS devices are not suitable for switching applications or voltage stabilization where static power dissipation is required.

This listing does not claim to be complete, but merely reflects the experience of EPCOS AG.

#### Display of ordering codes for EPCOS products

The ordering code for one and the same EPCOS product can be represented differently in data sheets, data books, other publications, on the EPCOS website, or in order-related documents such as shipping notes, order confirmations and product labels. **The varying representations of the ordering codes are due to different processes employed and do not affect the specifications of the respective products.** Detailed information can be found on the Internet under [www.epcos.com/orderingcodes](http://www.epcos.com/orderingcodes)

## Important notes

The following applies to all products named in this publication:

1. Some parts of this publication contain **statements about the suitability of our products for certain areas of application**. These statements are based on our knowledge of typical requirements that are often placed on our products in the areas of application concerned. We nevertheless expressly point out **that such statements cannot be regarded as binding statements about the suitability of our products for a particular customer application**. As a rule, we are either unfamiliar with individual customer applications or less familiar with them than the customers themselves. For these reasons, it is always ultimately incumbent on the customer to check and decide whether a product with the properties described in the product specification is suitable for use in a particular customer application.
2. We also point out that **in individual cases, a malfunction of electronic components or failure before the end of their usual service life cannot be completely ruled out in the current state of the art, even if they are operated as specified**. In customer applications requiring a very high level of operational safety and especially in customer applications in which the malfunction or failure of an electronic component could endanger human life or health (e.g. in accident prevention or lifesaving systems), it must therefore be ensured by means of suitable design of the customer application or other action taken by the customer (e.g. installation of protective circuitry or redundancy) that no injury or damage is sustained by third parties in the event of malfunction or failure of an electronic component.
3. **The warnings, cautions and product-specific notes must be observed.**
4. In order to satisfy certain technical requirements, **some of the products described in this publication may contain substances subject to restrictions in certain jurisdictions (e.g. because they are classed as hazardous)**. Useful information on this will be found in our Material Data Sheets on the Internet ([www.tdk-electronics.tdk.com/material](http://www.tdk-electronics.tdk.com/material)). Should you have any more detailed questions, please contact our sales offices.
5. We constantly strive to improve our products. Consequently, **the products described in this publication may change from time to time**. The same is true of the corresponding product specifications. Please check therefore to what extent product descriptions and specifications contained in this publication are still applicable before or when you place an order. We also **reserve the right to discontinue production and delivery of products**. Consequently, we cannot guarantee that all products named in this publication will always be available. The aforementioned does not apply in the case of individual agreements deviating from the foregoing for customer-specific products.
6. Unless otherwise agreed in individual contracts, **all orders are subject to our General Terms and Conditions of Supply**.

## Important notes

7. **Our manufacturing sites serving the automotive business apply the IATF 16949 standard.** The IATF certifications confirm our compliance with requirements regarding the quality management system in the automotive industry. Referring to customer requirements and customer specific requirements (“CSR”) TDK always has and will continue to have the policy of respecting individual agreements. Even if IATF 16949 may appear to support the acceptance of unilateral requirements, we hereby like to emphasize that **only requirements mutually agreed upon can and will be implemented in our Quality Management System.** For clarification purposes we like to point out that obligations from IATF 16949 shall only become legally binding if individually agreed upon.
8. The trade names EPCOS, CeraCharge, CeraDiode, CeraLink, CeraPad, CeraPlas, CSMP, CTVS, DeltaCap, DigiSiMic, ExoCore, FilterCap, FormFit, LeaXield, MiniBlue, MiniCell, MKD, MKK, MotorCap, PCC, PhaseCap, PhaseCube, PhaseMod, PhiCap, PowerHap, PQSine, PQvar, SIFERRIT, SIFI, SIKOREL, SilverCap, SIMDAD, SiMic, SIMID, SineFormer, SIOV, ThermoFuse, WindCap are **trademarks registered or pending** in Europe and in other countries. Further information will be found on the Internet at [www.tdk-electronics.tdk.com/trademarks](http://www.tdk-electronics.tdk.com/trademarks).

Release 2018-10

# Mouser Electronics

Authorized Distributor

Click to View Pricing, Inventory, Delivery & Lifecycle Information:

## EPCOS / TDK:

<a href="#"><u>B72500E0140K060</u></a>	<a href="#"><u>B72500E0140S260</u></a>	<a href="#"><u>B72500E0170K060</u></a>	<a href="#"><u>B72500E0200K060</u></a>	<a href="#"><u>B72500E0250K060</u></a>
<a href="#"><u>B72500E1140S260</u></a>	<a href="#"><u>B72500E2170K060</u></a>	<a href="#"><u>B72500E2170S160</u></a>	<a href="#"><u>B72500E5170S260</u></a>	<a href="#"><u>B72500E5200S160</u></a>
<a href="#"><u>B72510E0110K062</u></a>	<a href="#"><u>B72510E0140K062</u></a>	<a href="#"><u>B72510E0170K062</u></a>	<a href="#"><u>B72510E0200K062</u></a>	<a href="#"><u>B72510E0250K062</u></a>
<a href="#"><u>B72510E0300K062</u></a>	<a href="#"><u>B72510E1140S262</u></a>	<a href="#"><u>B72510E2170K062</u></a>	<a href="#"><u>B72510E9200S172</u></a>	<a href="#"><u>B72530E1140S262</u></a>
<a href="#"><u>B72580E0250K062</u></a>	<a href="#"><u>B72530E0250K062</u></a>	<a href="#"><u>B72520E0250K062</u></a>	<a href="#"><u>B72540E1300K062</u></a>	<a href="#"><u>B72540E0170K062</u></a>
<a href="#"><u>B72530E0170K062</u></a>	<a href="#"><u>B72520E0400K062</u></a>	<a href="#"><u>B72510E1250K062</u></a>	<a href="#"><u>B72540E0300K062</u></a>	<a href="#"><u>B72530E1250K062</u></a>
<a href="#"><u>B72520E1200K062</u></a>	<a href="#"><u>B72580E0140K062</u></a>	<a href="#"><u>B72580E0300K062</u></a>	<a href="#"><u>B72530E1200K062</u></a>	<a href="#"><u>B72540E0350K062</u></a>
<a href="#"><u>B72520E1250K062</u></a>	<a href="#"><u>B72540E3140S272</u></a>	<a href="#"><u>B72520E0350K062</u></a>	<a href="#"><u>B72530E0300K062</u></a>	<a href="#"><u>B72580E1140S262</u></a>
<a href="#"><u>B72520E0170K062</u></a>	<a href="#"><u>B72530E1170K062</u></a>	<a href="#"><u>B72590E8140S160</u></a>	<a href="#"><u>B72540E3300K072</u></a>	<a href="#"><u>B72540E0140K062</u></a>
<a href="#"><u>B72530E0200K062</u></a>	<a href="#"><u>B72580E3140S272</u></a>	<a href="#"><u>B72500E5250L060</u></a>	<a href="#"><u>B72520E0200K062</u></a>	<a href="#"><u>B72530E0350K062</u></a>
<a href="#"><u>B72520E1140S262</u></a>	<a href="#"><u>B72580E0200K062</u></a>	<a href="#"><u>B72590E0140L060</u></a>	<a href="#"><u>B72520E0140K062</u></a>	<a href="#"><u>B72530E0140K062</u></a>
<a href="#"><u>B72540E1140S262</u></a>	<a href="#"><u>B72580E0350K062</u></a>	<a href="#"><u>B72540E0250K062</u></a>	<a href="#"><u>B72540E0200K062</u></a>	<a href="#"><u>B72520E0300K062</u></a>
<a href="#"><u>B72580E0170K062</u></a>	<a href="#"><u>B72510E0350K062</u></a>	<a href="#"><u>B72540E0400K062</u></a>	<a href="#"><u>B72590E0170S160</u></a>	

Компания «Океан Электроники» предлагает заключение долгосрочных отношений при поставках импортных электронных компонентов на взаимовыгодных условиях!

Наши преимущества:

- Поставка оригинальных импортных электронных компонентов напрямую с производств Америки, Европы и Азии, а так же с крупнейших складов мира;
- Широкая линейка поставок активных и пассивных импортных электронных компонентов (более 30 млн. наименований);
- Поставка сложных, дефицитных, либо снятых с производства позиций;
- Оперативные сроки поставки под заказ (от 5 рабочих дней);
- Экспресс доставка в любую точку России;
- Помощь Конструкторского Отдела и консультации квалифицированных инженеров;
- Техническая поддержка проекта, помощь в подборе аналогов, поставка прототипов;
- Поставка электронных компонентов под контролем ВП;
- Система менеджмента качества сертифицирована по Международному стандарту ISO 9001;
- При необходимости вся продукция военного и аэрокосмического назначения проходит испытания и сертификацию в лаборатории (по согласованию с заказчиком);
- Поставка специализированных компонентов военного и аэрокосмического уровня качества (Xilinx, Altera, Analog Devices, Intersil, Interpoint, Microsemi, Actel, Aeroflex, Peregrine, VPT, Syfer, Eurofarad, Texas Instruments, MS Kennedy, Miteq, Cobham, E2V, MA-COM, Hittite, Mini-Circuits, General Dynamics и др.);

Компания «Океан Электроники» является официальным дистрибьютором и эксклюзивным представителем в России одного из крупнейших производителей разъемов военного и аэрокосмического назначения «JONHON», а так же официальным дистрибьютором и эксклюзивным представителем в России производителя высокотехнологичных и надежных решений для передачи СВЧ сигналов «FORSTAR».



## JONHON

«JONHON» (основан в 1970 г.)

Разъемы специального, военного и аэрокосмического назначения:

(Применяются в военной, авиационной, аэрокосмической, морской, железнодорожной, горно- и нефтедобывающей отраслях промышленности)

«FORSTAR» (основан в 1998 г.)

ВЧ соединители, коаксиальные кабели, кабельные сборки и микроволновые компоненты:

(Применяются в телекоммуникациях гражданского и специального назначения, в средствах связи, РЛС, а так же военной, авиационной и аэрокосмической отраслях промышленности).



Телефон: 8 (812) 309-75-97 (многоканальный)

Факс: 8 (812) 320-03-32

Электронная почта: [ocean@oceanchips.ru](mailto:ocean@oceanchips.ru)

Web: <http://oceanchips.ru/>

Адрес: 198099, г. Санкт-Петербург, ул. Калинина, д. 2, корп. 4, лит. А