

## Features

- Fast Switching Speed
- Surface Mount Package Ideally Suited for Automated Insertion
- For General Purpose Switching Applications
- **Totally Lead-Free & Fully RoHS Compliant (Notes 1 & 2)**
- **Halogen and Antimony Free. "Green" Device (Notes 3 & 4)**
- **Qualified to AEC-Q101 Standards for High Reliability**

## Mechanical Data

- Case: SOT23
- Case Material: Molded Plastic, "Green" Molding Compound (Note 2). UL Flammability Classification Rating 94V-0
- Moisture Sensitivity: Level 1 per J-STD-020
- Terminals: Matte Tin Finish annealed over Alloy 42 leadframe (Lead Free Plating). Solderable per MIL-STD-202, Method 208
- Polarity: See Diagram
- Weight: 0.008 grams (approximate)

SOT23



Top View

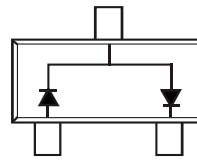

 Top View  
Internal Schematic

## Ordering Information (Note 5)

| Part Number | Qualification | Case  | Packaging          |
|-------------|---------------|-------|--------------------|
| BAV99-7-F   | Commercial    | SOT23 | 3,000/Tape & Reel  |
| BAV99-13-F  | Commercial    | SOT23 | 10,000/Tape & Reel |
| BAV99Q-7-F  | Automotive    | SOT23 | 3,000/Tape & Reel  |
| BAV99Q-13-F | Automotive    | SOT23 | 10,000/Tape & Reel |

- Notes:
1. No purposely added lead. Fully EU Directive 2002/95/EC (RoHS) & 2011/65/EU (RoHS 2) compliant.
  2. See <http://www.diodes.com> for more information about Diodes Incorporated's definitions of Halogen- and Antimony-free, "Green" and Lead-free.
  3. Halogen- and Antimony-free "Green" products are defined as those which contain <900ppm bromine, <900ppm chlorine (<1500ppm total Br + Cl) and <1000ppm antimony compounds.
  4. Product manufactured with Date Code 9W (week 39, 2009) and newer are built with Green Molding Compound. Product manufactured prior to Date Code 9W are built with Non-Green Molding Compound and may contain Halogens or Sb<sub>2</sub>O<sub>3</sub> Fire Retardants.
  5. For packaging details, go to our website at <http://www.diodes.com>.

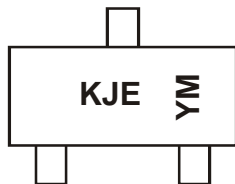
## Marking Information



K = SAT (Shanghai Assembly / Test site)  
 JE = Product Type Marking Code  
 YM = Date Code Marking  
 Y = Year (ex: Z = 2012)  
 M = Month (ex: 9 = September)

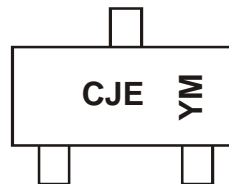

C = CAT (Chengdu Assembly / Test site)  
 JE = Product Type Marking Code  
 YM = Date Code Marking  
 Y = Year (ex: Z = 2012)  
 M = Month (ex: 9 = September)

### Date Code Key

| Year | 1998 | 1999 | ..... | 2006 | 2007 | 2008 | 2009 | 2010 | 2011 | 2012 | 2013 | 2014 | 2015 | 2016 | 2017 |
|------|------|------|-------|------|------|------|------|------|------|------|------|------|------|------|------|
| Code | J    | K    | ..... | T    | U    | V    | W    | X    | Y    | Z    | A    | B    | C    | D    | E    |

| Month | Jan | Feb | Mar | Apr | May | Jun | Jul | Aug | Sep | Oct | Nov | Dec |
|-------|-----|-----|-----|-----|-----|-----|-----|-----|-----|-----|-----|-----|
| Code  | 1   | 2   | 3   | 4   | 5   | 6   | 7   | 8   | 9   | O   | N   | D   |

**Maximum Ratings** @T<sub>A</sub> = 25°C unless otherwise specified

| Characteristic                            | Symbol              | Value       | Unit |
|---|---------------------|-------------|------|
| Non-Repetitive Peak Reverse Voltage       | V <sub>RM</sub>     | 100         | V    |
| Peak Repetitive Reverse Voltage           | V <sub>R(RM)</sub>  | 75          | V    |
| Working Peak Reverse Voltage              | V <sub>R(WM)</sub>  |             |      |
| DC Blocking Voltage                       | V <sub>R</sub>      |             |      |
| RMS Reverse Voltage                       | V <sub>R(RMS)</sub> | 53          | V    |
| Forward Continuous Current (Note 6)       | I <sub>FM</sub>     | 300         | mA   |
| Non-Repetitive Peak Forward Surge Current | I <sub>FSM</sub>    | 2.0         | A    |
|   |                     | @ t = 1.0μs |      |
|   |                     | @ t = 1.0s  |      |

**Thermal Characteristics**

| Characteristic                                      | Symbol                            | Value       | Unit |
|---|-----------------------------------|-------------|------|
| Power Dissipation (Note 6)                          | P <sub>D</sub>                    | 350         | mW   |
| Thermal Resistance Junction to Ambient Air (Note 6) | R <sub>θJA</sub>                  | 357         | °C/W |
| Operating and Storage Temperature Range             | T <sub>J</sub> , T <sub>STG</sub> | -65 to +150 | °C   |

**Electrical Characteristics** @T<sub>A</sub> = 25°C unless otherwise specified

| Characteristic                     | Symbol             | Min | Max                           | Unit                 | Test Condition   |
|------------------------------------|--------------------|-----|-------------------------------|----------------------|--|
| Reverse Breakdown Voltage (Note 7) | V <sub>(BR)R</sub> | 75  | —                             | V                    | I <sub>R</sub> = 2.5μA   |
| Forward Voltage                    | V <sub>F</sub>     | —   | 0.715<br>0.855<br>1.0<br>1.25 | V                    | I <sub>F</sub> = 1.0mA<br>I <sub>F</sub> = 10mA<br>I <sub>F</sub> = 50mA<br>I <sub>F</sub> = 150mA                   |
| Reverse Current (Note 7)           | I <sub>R</sub>     | —   | 2.5<br>50<br>30<br>25         | μA<br>μA<br>μA<br>nA | V <sub>R</sub> = 75V, T <sub>J</sub> = 150°C<br>V <sub>R</sub> = 25V, T <sub>J</sub> = 150°C<br>V <sub>R</sub> = 20V |
| Total Capacitance                  | C <sub>T</sub>     | —   | 2.0                           | pF                   | V <sub>R</sub> = 0, f = 1.0MHz   |
| Reverse Recovery Time              | t <sub>rr</sub>    | —   | 4.0                           | ns                   | I <sub>F</sub> = I <sub>R</sub> = 10mA,<br>I <sub>rr</sub> = 0.1 x I <sub>R</sub> , R <sub>L</sub> = 100Ω            |

Notes: 6. Part mounted on Polyimide PC board with pad dimensions 1.13mm x 1.27mm.  
7. Short duration pulse test used to minimize self-heating effect.

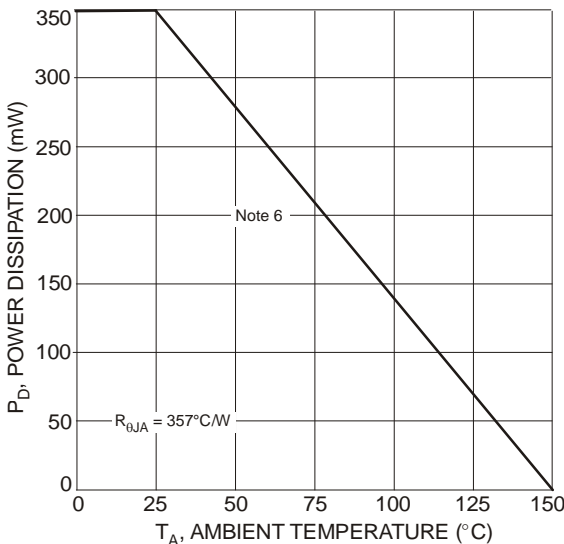

Fig. 1 Power Derating Curve

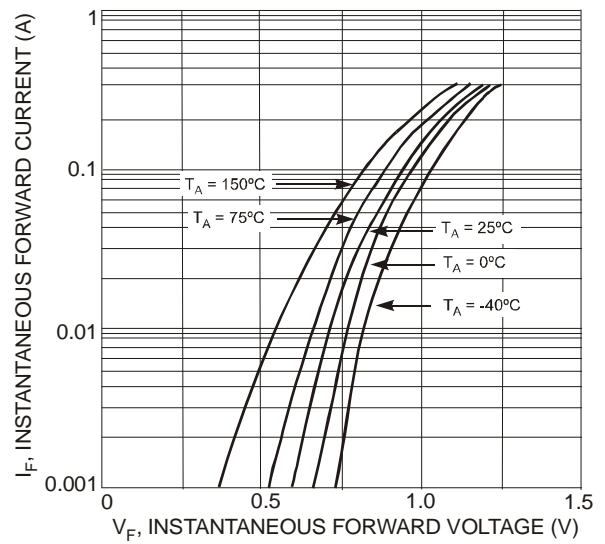

Fig. 2 Forward Characteristics

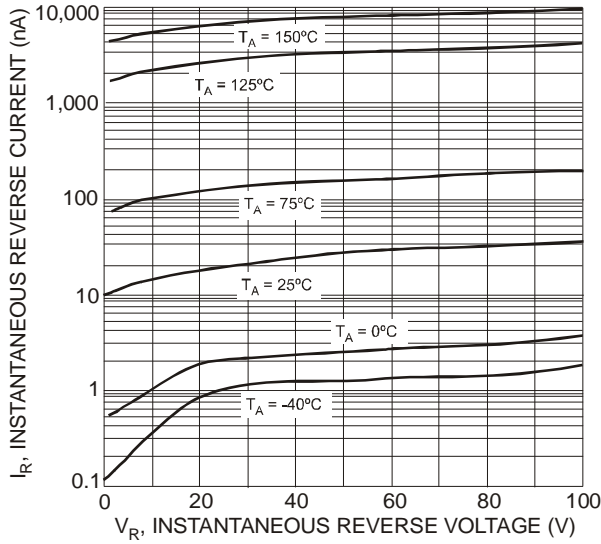

Fig. 3 Typical Reverse Characteristics

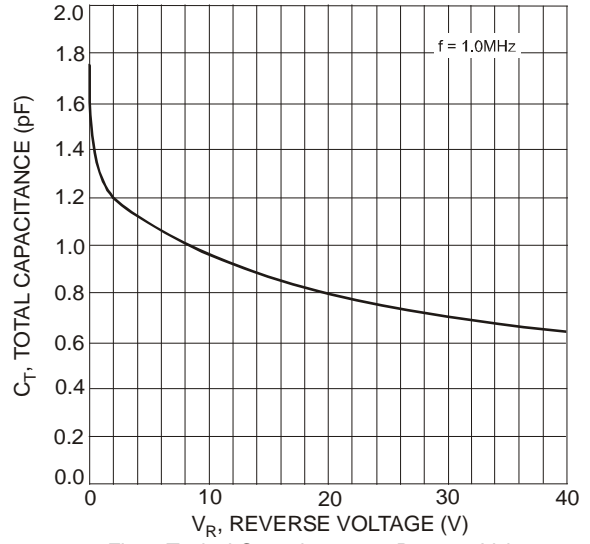
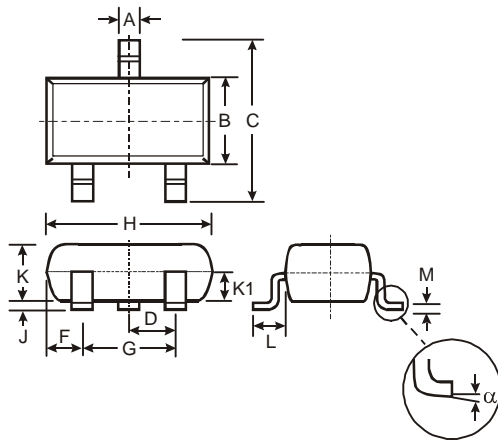

Fig. 4 Typical Capacitance vs. Reverse Voltage

**Package Outline Dimensions**



| SOT23 |       |      |       |
|-------|-------|------|-------|
| Dim   | Min   | Max  | Typ   |
| A     | 0.37  | 0.51 | 0.40  |
| B     | 1.20  | 1.40 | 1.30  |
| C     | 2.30  | 2.50 | 2.40  |
| D     | 0.89  | 1.03 | 0.915 |
| F     | 0.45  | 0.60 | 0.535 |
| G     | 1.78  | 2.05 | 1.83  |
| H     | 2.80  | 3.00 | 2.90  |
| J     | 0.013 | 0.10 | 0.05  |
| K     | 0.903 | 1.10 | 1.00  |
| K1    | -     | -    | 0.400 |
| L     | 0.45  | 0.61 | 0.55  |
| M     | 0.085 | 0.18 | 0.11  |
| α     | 0°    | 8°   | -     |

All Dimensions in mm

**Suggested Pad Layout**

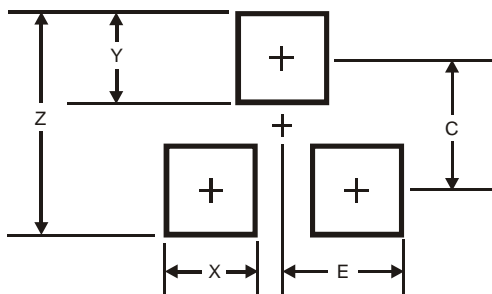

| Dimensions | Value (in mm) |
|------------|---------------|
| Z          | 2.9           |
| X          | 0.8           |
| Y          | 0.9           |
| C          | 2.0           |
| E          | 1.35          |

**IMPORTANT NOTICE**

DIODES INCORPORATED MAKES NO WARRANTY OF ANY KIND, EXPRESS OR IMPLIED, WITH REGARDS TO THIS DOCUMENT, INCLUDING, BUT NOT LIMITED TO, THE IMPLIED WARRANTIES OF MERCHANTABILITY AND FITNESS FOR A PARTICULAR PURPOSE (AND THEIR EQUIVALENTS UNDER THE LAWS OF ANY JURISDICTION).

Diodes Incorporated and its subsidiaries reserve the right to make modifications, enhancements, improvements, corrections or other changes without further notice to this document and any product described herein. Diodes Incorporated does not assume any liability arising out of the application or use of this document or any product described herein; neither does Diodes Incorporated convey any license under its patent or trademark rights, nor the rights of others. Any Customer or user of this document or products described herein in such applications shall assume all risks of such use and will agree to hold Diodes Incorporated and all the companies whose products are represented on Diodes Incorporated website, harmless against all damages.

Diodes Incorporated does not warrant or accept any liability whatsoever in respect of any products purchased through unauthorized sales channel. Should Customers purchase or use Diodes Incorporated products for any unintended or unauthorized application, Customers shall indemnify and hold Diodes Incorporated and its representatives harmless against all claims, damages, expenses, and attorney fees arising out of, directly or indirectly, any claim of personal injury or death associated with such unintended or unauthorized application.

Products described herein may be covered by one or more United States, international or foreign patents pending. Product names and markings noted herein may also be covered by one or more United States, international or foreign trademarks.

**LIFE SUPPORT**

Diodes Incorporated products are specifically not authorized for use as critical components in life support devices or systems without the express written approval of the Chief Executive Officer of Diodes Incorporated. As used herein:

A. Life support devices or systems are devices or systems which:

1. are intended to implant into the body, or
2. support or sustain life and whose failure to perform when properly used in accordance with instructions for use provided in the labeling can be reasonably expected to result in significant injury to the user.

B. A critical component is any component in a life support device or system whose failure to perform can be reasonably expected to cause the failure of the life support device or to affect its safety or effectiveness.

Customers represent that they have all necessary expertise in the safety and regulatory ramifications of their life support devices or systems, and acknowledge and agree that they are solely responsible for all legal, regulatory and safety-related requirements concerning their products and any use of Diodes Incorporated products in such safety-critical, life support devices or systems, notwithstanding any devices- or systems-related information or support that may be provided by Diodes Incorporated. Further, Customers must fully indemnify Diodes Incorporated and its representatives against any damages arising out of the use of Diodes Incorporated products in such safety-critical, life support devices or systems.

Copyright © 2012, Diodes Incorporated

[www.diodes.com](http://www.diodes.com)

Компания «Океан Электроники» предлагает заключение долгосрочных отношений при поставках импортных электронных компонентов на взаимовыгодных условиях!

Наши преимущества:

- Поставка оригинальных импортных электронных компонентов напрямую с производств Америки, Европы и Азии, а так же с крупнейших складов мира;
- Широкая линейка поставок активных и пассивных импортных электронных компонентов (более 30 млн. наименований);
- Поставка сложных, дефицитных, либо снятых с производства позиций;
- Оперативные сроки поставки под заказ (от 5 рабочих дней);
- Экспресс доставка в любую точку России;
- Помощь Конструкторского Отдела и консультации квалифицированных инженеров;
- Техническая поддержка проекта, помощь в подборе аналогов, поставка прототипов;
- Поставка электронных компонентов под контролем ВП;
- Система менеджмента качества сертифицирована по Международному стандарту ISO 9001;
- При необходимости вся продукция военного и аэрокосмического назначения проходит испытания и сертификацию в лаборатории (по согласованию с заказчиком);
- Поставка специализированных компонентов военного и аэрокосмического уровня качества (Xilinx, Altera, Analog Devices, Intersil, Interpoint, Microsemi, Actel, Aeroflex, Peregrine, VPT, Syfer, Eurofarad, Texas Instruments, MS Kennedy, Miteq, Cobham, E2V, MA-COM, Hittite, Mini-Circuits, General Dynamics и др.);

Компания «Океан Электроники» является официальным дистрибьютором и эксклюзивным представителем в России одного из крупнейших производителей разъемов военного и аэрокосмического назначения «JONHON», а так же официальным дистрибьютором и эксклюзивным представителем в России производителя высокотехнологичных и надежных решений для передачи СВЧ сигналов «FORSTAR».



## JONHON

«JONHON» (основан в 1970 г.)

Разъемы специального, военного и аэрокосмического назначения:

(Применяются в военной, авиационной, аэрокосмической, морской, железнодорожной, горно- и нефтедобывающей отраслях промышленности)

«FORSTAR» (основан в 1998 г.)

ВЧ соединители, коаксиальные кабели, кабельные сборки и микроволновые компоненты:

(Применяются в телекоммуникациях гражданского и специального назначения, в средствах связи, РЛС, а так же военной, авиационной и аэрокосмической отраслях промышленности).



Телефон: 8 (812) 309-75-97 (многоканальный)

Факс: 8 (812) 320-03-32

Электронная почта: [ocean@oceanchips.ru](mailto:ocean@oceanchips.ru)

Web: <http://oceanchips.ru/>

Адрес: 198099, г. Санкт-Петербург, ул. Калинина, д. 2, корп. 4, лит. А