

Anaren Integrated Radio (AIR)

Low-power RF modules, firmware & development tools that make it easy to 'go wireless'

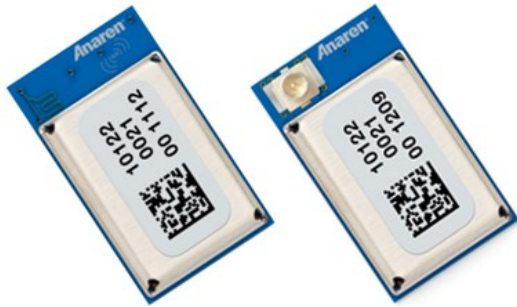

Anaren Integrated Radio

A2530E24x User's Manual

Release Date: 01/23/15

THIS PAGE INTENTIONALLY LEFT BLANK

USER'S MANUAL

Models A2530E24A and A2530E24C

Contents

1.	Overview	5
1.1.	A2530E24A	5
1.2.	A2530E24C	5
1.3.	Features.....	6
1.4.	Theory of Operation.....	6
1.5.	Applications	8
2.	Approvals and Usage	9
2.1.	Product Approvals.....	9
2.1.1.	USA (<i>Federal Communications Commission, FCC</i>).....	9
2.1.1.1.	FCC Labeling Requirements	9
2.1.1.2.	End User Manual	10
2.1.1.3.	RF Exposure.....	10
2.1.2.	Canada (<i>Industry Canada, IC</i>).....	10
2.1.2.1.	IC Labeling Requirements	11
2.1.2.2.	RF Exposure.....	13
2.1.3.	Europe (<i>Conformité Européenne, CE</i>).....	13
2.2.	Potential Interference Sources	14
2.2.1.	WLAN.....	14
2.2.2.	Bluetooth®	15
2.2.3.	Microwave ovens.....	15
2.2.4.	Other Interference	15
2.2.5.	Time critical data.....	15
2.3.	Approved Usage	16
2.3.1.	USA and Canada.....	16
2.3.2.	Europe	17
3.	Electrical Characteristics	19
3.1.	Absolute Maximum Ratings	19
3.2.	Operating Conditions	20
3.3.	Pin Out.....	20
3.3.1.	A2530E24xZ1 (<i>Module with AIR-ZNP firmware</i>).....	20
3.3.2.	A2530E24x (<i>Native Module Pinout</i>).....	22
3.4.	Recommended Layout (dimensions in mm)	24
3.5.	Power Supply Considerations.....	26
4.	Mechanical and Process.....	27
4.1.	Radio Module Details (dimensions in mm).....	27
4.1.1.	A2530E24A.....	27
4.1.2.	A2530E24C.....	27
4.2.	Packaging Details (dimensions in mm).....	28
4.2.1.	Matrix Tray Packaging	28
4.2.2.	Tape-Reel Packaging	28
4.3.	Soldering.....	29
4.3.1.	Manual Mounting Procedure	29
4.3.2.	Automated Mounting Procedure	30

THIS PAGE INTENTIONALLY LEFT BLANK

1. Overview

The A2530E24A and A2530E24C are surface mount modules integrating Texas Instruments' (TI) CC2530 system-on-chip (SoC) transceiver with the CC2591 PA/LNA device for increased range. The A2530E24A has an integral antenna, whereas the A2530E24C utilizes an external antenna through a U.FL connector (see Table 1). These modules incorporate a crystal, the required RF matching and filtering for regulatory compliance as well as filtering on all digital lines for noise reduction and sensitivity. They operate in the global non-licensed 2.4GHz ISM/SRD frequency band. The modules are ideal for achieving low power, long range wireless connectivity without having to deal with extensive protocol, RF, antenna design and regulatory compliance issues; as a result, costs and time to market can be reduced significantly. They are completely tested to provide consistent performance.

The A2530E24A and A2530E24C modules have received regulatory approvals for modular devices in the United States (FCC), Canada (IC) and Europe (ETSI). The modular approval allows the end user to place either an A2530E24A or an A2530E24C with an approved antenna inside a finished product without having to perform costly regulatory testing for an intentional RF radiator. Section 2.3 has information on the requirements for the end user/integrator to fulfill in order to use the modules without intentional radiator regulatory testing.

The A2530E24A and A2530E24C are based on the CC2530 SoC transceiver and the CC2591 range extender chips, both from Texas Instruments (TI). The CC2530 combines the excellent performance of a leading RF transceiver with an industry-standard enhanced 8051 microcontroller unit (MCU), in-system programmable flash memory, 8-KB RAM, and many other powerful features. The CC2530 has various operating modes, making it highly suited for systems where ultralow power consumption is required. Short transition times between operating modes further ensure low energy consumption. All control lines are provided at module level for full control of the operation. Please see the datasheets for CC2530 and CC2591 (www.ti.com) for how to operate, program and control these modules.

The A2530E24A and A2530E24C modules measure 11 mm x 19 mm x 2.5 mm. The modules are footprint compatible with each other.

1.1. A2530E24A

The A2530E24A has an integral antenna, providing high efficiency and near omni-directional radiation pattern. This approach offers the lowest system cost when the application allows collocation of radio and antenna. See Figure 8 - Figure 9 for more information on antenna location and enclosure considerations.

1.2. A2530E24C

The A112530E24C has a compact antenna connector that allows for locating the antenna away from the module due to form/function or in order to exit a metal enclosure. See Table 1 for a list of approved antennas.

1.3. Features

Features:

- 2.4 GHz IEEE 802.15.4 compliant
- 2.2 to 3.6 V operation
- High-Performance and low-power 8051 microcontroller core
- Multiple power modes to control current consumption
- 256 kB Programmable Flash
- 8 kB RAM with retention in all power modes
- Programmable output power up to +17 dBm
- 21 General Purpose I/O Pins
- IEEE 802.15.4 MAC Timer, General-Purpose Timers
- RSSI/LQI support
- Battery Monitor and Temperature Sensor
- 12-Bit ADC with eight channels and configurable resolution
- AES Security Coprocessor
- 2 USARTs with several serial protocol support
- Watchdog Timer
- RoHS compliant
- Shielded package
- LGA footprint
- Very small package size:
11mm x 19mm x 2.5mm
- Approximate weight 0.7 grams

Benefits Summary:

- Operating temperature-40 °C to +85 °C
- 100% RF tested in production for repeatable performance
- No RF engineering experience necessary
- No protocol experience necessary
- Only requires a 2 layer Host PCB implementation
- FCC 15.247, IC RSS-210 and IC RSS-Gen certified.
- Compliant with ETSI EN 300 328
- No regulatory "Intentional radiator" testing required for integrating module into end product. Simple certification labeling replaces testing.

1.4. Theory of Operation

The A2530E24A and A2530E24C modules operate in the global 2.4 GHz ISM/SRD frequency band. They can be used to implement a variety of networks, including point to point, point to multi-point, peer to peer and mesh networks.

Figure 1 and Figure 2 show the functionality of A2530E24A and A2530E24C, respectively. Both modules operate in a similar manner except with respect to the antenna, in that the A2530E24A module communicates through a built-in antenna, whereas the A2530E24C communicates through an external antenna attached to a U.FL connector.

The description of the functional blocks shown in Figure 1 and Figure 2 is given as follows:

- **Antenna**
 - The antenna couples energy between the air and the module. The integral antenna and the external monopole antenna, both centered at 2441.75 MHz, provide a near omni-directional antenna pattern with high efficiency such that the application will work equally well in any direction. Note that the end radiation pattern depends not only on the antenna, but also the ground plane, enclosure and installation environment.
- **Matching & Filtering**
 - Matching provides the correct loading of the transmit amplifier to achieve the highest output power as well as the correct loading for the receive LNA to achieve the best sensitivity.
 - Filtering removes spurious signals to comply with regulatory intentional radiator requirements, provides reduced susceptibility to power supply and digital noise, and filters out RF and high frequency noise from the communication data and control link.
- **Range Extender**
 - The range extender serves as an RF front-end for low power transceiver. It contains PA, LNA, switches, RF-matching and a balun.
- **TX/RX Chain**
 - The TX/RX chain handles transmitting and receiving of the communication data based on the radio register settings. It involves the coordination of several blocks including modulator, demodulator, AGC control, frequency synthesizer and frame control.
- **Crystal**
 - The crystal oscillator provides the necessary clock reference for the whole module operation. The A2530E24A and A2530E24C modules use a 32 MHz crystal.
- **Power Management**
 - Power management ensures a stable supply for the internal functions, as well as providing means for a low power sleep mode.
- **CPU and Memory**
 - The 8051 CPU core used in the CC2530 device is a single-cycle 8051-compatible core. It has three different memory-access buses (SFR, DAT and CODE/XDATA) with single-cycle access to SFR, DATA, and the main SRAM. It also includes a debug interface and an 18-input extended interrupt unit.
 - The memory arbiter connects the CPU and DMA controller with the physical memories and all peripherals through the SFR bus.
 - The 8-BK SRAM maps to the DATA memory space and to parts of the XDATA memory spaces. This is an ultralow-power SRAM that retains its contents even when the digital part is powered off.
 - 256 KB flash block provides in-circuit programmable non-volatile program memory for the device, and maps into the CODE and XDATA memory spaces. In addition to holding the program code, it also allows the application to save data that must be preserved such that it is available after restarting the device.
- **I/O Controller**
 - The I/O controller is responsible for all general-purpose I/O pins. The CPU can configure whether peripheral modules control certain pins or they are under software control, and if so, whether they are configured as input or output.

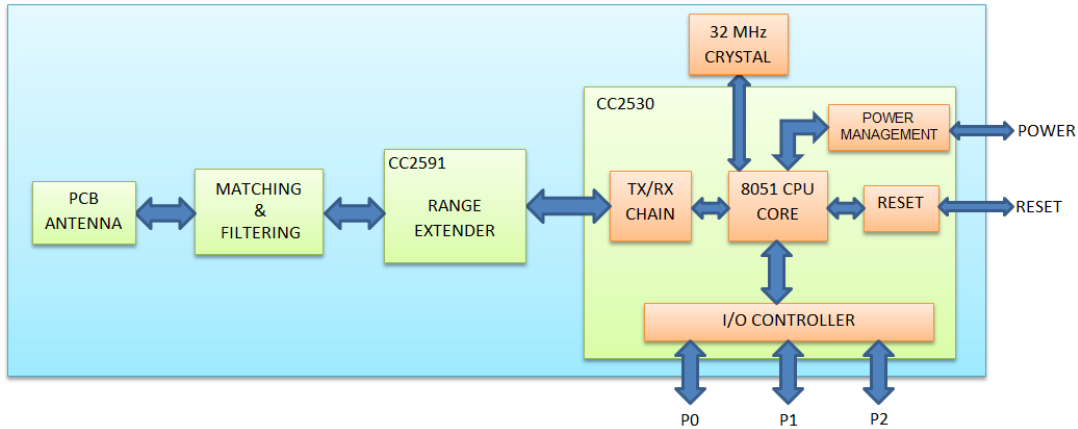

Figure 1 The functionality of the A2530E24A, using an internal antenna

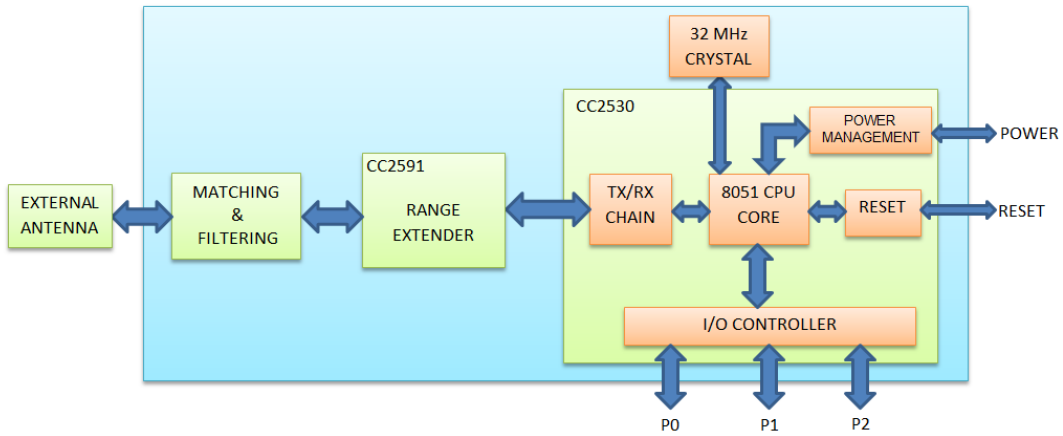

Figure 2 The functionality of the A2530E24C, using an external antenna

Table 1 Approved Antennas

Item	Part Number	Manufacturer	Type	Gain (dBi)
1	Integral part of A2530E24A	Anaren	Integral Antenna	2
2	66089-2406	Anaren	Monopole whip, 6 mm lead	3
3	66089-2430	Anaren	Monopole whip, 30mm lead	3

1.5. Applications

- ZigBee® Systems
- Home/Building Automation
- Lighting Systems
- Industrial Control and Monitoring
- Health Care
- Low-Power Wireless Sensor Networks

2. Approvals and Usage

The A2530E24A and A2530E24C have been designed to meet most national regulations for worldwide ISM band use. In particular, the radio modules have been certified to the following standards.

2.1. Product Approvals

2.1.1. USA (Federal Communications Commission, FCC)

The A2530E24A and A2530E24C modules have been tested to comply with FCC CFR47 Part 15 sub-part C “Intentional Radiators” standard. The modules meet the requirements for modular transmitter approval as detailed in FCC public notice DA 00-1407 released in June 26, 2000. The modular transmitter approval eliminates the need to re-perform costly and time-consuming ‘intentional radiator’ testing when submitting an end product for certification.

(15.19a3) The A2530E24x module complies with part 15 of the FCC rules. Operation is subject to the following two conditions: (1) This device may not cause harmful interference, and (2) this device must accept any interference received, including interference that may cause undesired operation.

Any changes or modifications not expressly approved by the party responsible for compliance could void the user’s authority to operate the equipment.

2.1.1.1. FCC Labeling Requirements

The A2530E24A and A2530E24C modules have been labeled with their own FCC ID number and if the FCC ID is not visible when the module is installed inside another device, then the outside of the finished product into which the module is installed must also display a label referring to the enclosed module. This exterior label can use wording such as the following:

Contains Transmitter Module FCC ID: X7J-A11091301

-or-

Contains FCC ID: X7J-A11091301

This device complies with Part 15 of the FCC Rules.

Operation is subject to the following two conditions:

(1) This device may not cause harmful interference, and (2) this device must accept any interference received, including interference that may cause undesired operation.

2.1.1.2. End User Manual

The end user manual should include the following statement:

This equipment has been tested and found to comply with the limits for a Class B digital device, pursuant to part 15 of the FCC Rules. These limits are designed to provide reasonable protection against harmful interference in a residential installation. This equipment generates, uses and can radiate radio frequency energy and, if not installed and used in accordance with the instructions, may cause harmful interference to radio communications. However, there is no guarantee that interference will not occur in a particular installation. If this equipment does cause harmful interference to radio or television reception, which can be determined by turning the equipment off and on, the user is encouraged to try to correct the interference by one or more of the following measures:

- Reorient or relocate the receiving antenna.
- Increase the separation between the equipment and receiver.
- Connect the equipment into an outlet on a circuit different from that to which the receiver is connected.
- Consult the dealer or an experienced radio/TV technician for help.

2.1.1.3. RF Exposure

All transmitters regulated by FCC must comply with RF exposure requirements. OET Bulletin 65 “Evaluating Compliance with FCC Guidelines for Human Exposure to Radio Frequency Electromagnetic Fields” provides assistance in determining whether proposed or existing transmitting facilities, operations or devices comply with limits for human exposure to Radio Frequency (RF) fields adopted by the Federal Communications Commission (FCC). The bulletin offers guidelines and suggestions for evaluating compliance.

If appropriate, compliance with exposure guidelines for mobile and unlicensed devices can be accomplished by the use of warning labels and by providing users with information concerning minimum separation distances from transmitting structures and proper installation of antennas.

The following statement must be included as a CAUTION statement in manuals and OEM products to alert users of FCC RF Exposure compliance:

To satisfy FCC RF Exposure requirements for mobile and base station transmission devices, a separation distance of 20 cm or more should be maintained between the antenna of this device and persons during operation. To ensure compliance, operation at closer than this distance is not recommended. The antenna(s) used for this transmitter must not be co-located or operating in conjunction with any other antenna or transmitter.

If the A2530E24A and A2530E24C modules are used in a portable application (antenna is less than 20 cm from persons during operation), the integrator/OEM is responsible for performing Specific Absorption Rate (SAR) testing in accordance with FCC rules 2.1093.

2.1.2. Canada (Industry Canada, IC)

The A2530E24A and A2530E24C modules have been certified for use in Canada under Industry Canada (IC) Radio Standards Specification (RSS) RSS-210 and RSS-Gen.

From section 3.2 RSS-Gen, Issue 3, December 2010, Modular Approval for Category I Equipment or Category II Equipment:

“Modular approval permits the installation of the same module in a host device or multiple host devices without the need to recertify the device. Equipment certification for a modular device may be sought for either Category I equipment or Category II equipment.

Transmitters designed as modules for the installation in a host device may obtain equipment certification as a modular device provided that the applicable RSS is met and the following conditions in this section are met.”

In section 7.1.2 Transmitter Antenna, it has been mentioned that the user manuals for transmitters shall display the following notice in a conspicuous location:

Notice: *Under Industry Canada regulations, this radio transmitter may only operate using an antenna of a type and maximum (or lesser) gain approved for the transmitter by Industry Canada. To reduce potential radio interference to other users, the antenna type and its gain should be so chosen that the equivalent isotropically radiated power (e.i.r.p.) is not more than that necessary for successful communication.*

Avis: *Sous la réglementation d'Industrie Canada, ce transmetteur radio ne peut fonctionner qu'en utilisant seulement une antenne d'un type et d'un maximum (ou moins) de gain approuvé pour l'émetteur par Industrie Canada. Pour réduire des potentielles interférences radio pour les autres utilisateurs, le type d'antenne et son gain doivent être choisis de sorte que la puissance isotrope rayonnée équivalente (PIRE) ne dépasse pas ce qui est nécessaire pour une communication réussie.*

In section 7.1.2 Transmitter Antenna, it has been mentioned that the user manuals for transmitters equipped with detachable antennas shall also contain the following notice in a conspicuous location:

Notice: *This radio transmitter (IC: 8975A-A11091301) has been approved by Industry Canada to operate with the antenna types listed below with the maximum permissible gain and required antenna impedance for each antenna type indicated. Antenna types not included in this list, having a gain greater than the maximum gain indicated for that type, are strictly prohibited for use with this device.*

Avis: *Cet émetteur radio (IC: 8975A-A11091301) a été approuvé par Industrie Canada pour fonctionner avec les types d'antennes énumérés ci-dessous avec le gain maximal admissible et l'impédance d'antenne requise pour chaque type d'antenne indiqué. Les types d'antennes ne figurant pas dans cette liste, ayant un gain supérieur au gain maximal indiqué pour ce type, sont strictement interdits pour l'utilisation avec cet appareil.*

2.1.2.1. IC Labeling Requirements

From section 3.2.1 RSS-Gen, Issue 3, December 2010, Labeling Requirements for the Host Device:

“The host device shall be properly labeled to identify the modules within the host device. The Industry Canada certification label of a module shall be clearly visible at all times when installed in the host device, otherwise the host device must be labeled to display the Industry Canada

certification number of the module, preceded by the words "Contains transmitter module", or the word "Contains", or similar wording expressing the same meaning."

From section 5.2, RSS-Gen, Issue 3, December 2010, Equipment Certification Numbers and Labels:

"Every unit of Category I radio apparatus certified for marketing and use in Canada shall bear a permanent label on which is indelibly displayed the model number and Industry Canada certification number of the equipment model (transmitter, receiver, or inseparable combination thereof). Each model shall be identified by a unique combination of a model number and a certification number, which are assigned as described below in this section.

The label shall be securely affixed to a permanently attached part of the device, in a location where it is visible or easily accessible to the user, and shall not be readily detachable. The label shall be sufficiently durable to remain fully legible and intact on the device in all normal conditions of use throughout the device's expected lifetime. These requirements may be met either by a separate label or nameplate permanently attached to the device or by permanently imprinting or impressing the label directly onto the device.

The label text shall be legible without the aid of magnification, but is not required to be larger than 8-point font size. If the device is too small to meet this condition, the label information may be included in the user manual upon agreement with Industry Canada."

Section 5.2 continues:

"The model number is assigned by the applicant and shall be unique to each model of radio apparatus under that applicant's responsibility. The model number shall be displayed on the label preceded by the text: "Model:"; so it appears as follows:

Model: model number assigned by applicant"

Label:

Contains/Contient IC: 8975A- A11091301

Notice: This device complies with Industry Canada licence-exempt RSS standard(s). Operation is subject to the following two conditions: (1) this device may not cause interference, and (2) this device must accept any interference, including interference that may cause undesired operation of the device.

Avis: Cet appareil est conforme avec Industrie Canada RSS standard exempts de licence (s). Son fonctionnement est soumis aux deux conditions suivantes: (1) cet appareil ne peut pas provoquer d'interférences et (2) cet appareil doit accepter toute interférence, y compris les interférences qui peuvent causer un mauvais fonctionnement du dispositif.

From section 7.1.4, RSS-Gen, Issue 3, December 2010, Radio Apparatus Containing Digital Circuits (ICES-003):

"Radio apparatus containing digital circuitry which can function separately from the operation of a transmitter or an associated transmitter, shall comply with ICES-003. In such cases, the

labeling requirements of the applicable RSS apply, rather than the labelling requirements in ICES-003."

For more information see: Industry Canada <http://www.ic.gc.ca/>

2.1.2.2. RF Exposure

All transmitters regulated by IC must comply with RF exposure limits as set forth in RSS-102, Issue 4, Section 4, "Exposure Limits". Furthermore RSS-102, Issue 4, Section 2 "Certification Requirements", provides assistance in determining the specific requirements for compliance. If appropriate, compliance with exposure guidelines for mobile and unlicensed devices can be accomplished by the use of warning labels and by providing users with information concerning minimum separation distances from transmitting structures and proper installation of antennas.

The following statement must be included as a CAUTION statement in manuals and OEM products to alert users of IC RF Exposure compliance:

Notice: To satisfy IC RF Exposure requirements for mobile and base station transmission devices, a separation distance of 20 cm or more should be maintained between the antenna of this device and persons during operation. To ensure compliance, operation at closer than this distance is not recommended. The antenna(s) used for this transmitter must not be co-located or operating in conjunction with any other antenna or transmitter.

Avis: Pour répondre à la IC d'exposition pour les besoins de base et mobiles dispositifs de transmission de la station, sur une distance de séparation de 20 cm ou plus doit être maintenue entre l'antenne de cet appareil et les personnes en cours de fonctionnement. Pour assurer le respect, l'exploitation de plus près à cette distance n'est pas recommandée. L'antenne (s) utilisé pour cet émetteur ne doit pas être co-localisés ou fonctionner conjointement avec une autre antenne ou transmetteur.

If the A2530E24A and A2530E24C modules are used in a portable application (antenna is less than 20 cm from persons during operation), the integrator/OEM is responsible for performing Specific Absorption Rate (SAR) testing in accordance with IC rules and methods of RSS-102.

2.1.3. Europe (Conformité Européenne, CE)

The A2530E24A and A2530E24C modules have been certified for use in European countries covered by ETSI regulations. The following tests have been performed and the modules found to be compliant to the requirements:

- Test standard ETSI EN 300 328 V1.8.1 (2012-04)
 - ✓ RF Output Power
 - ✓ Duty Cycle
 - ✓ Occupied Bandwidth
 - ✓ RF Output Power
 - ✓ Spectral Power Density

- ✓ Transmitter Spurious Emissions
- ✓ Receiver Spurious Emissions
- Electro-Static Discharge and RF Immunity (ETSI EN 301 489-17)
- RF Exposure (ETSI EN 62311:2008)
- Safety (IEC 60950-1:2005 and EN 60950-1:2006)

A helpful document that can be a starting point in understanding the use of short range devices (SRD) in Europe is the European Radio Communications Committee (ERC) Recommendation 70-03 E, downloadable from the European Radio Communications Office (ERO) <http://www.erodocdb.dk/Docs/doc98/official/pdf/REC7003E.PDF>.

The end user is responsible for ensuring compliance with harmonized frequencies and labeling requirements for each country the end device is marketed and sold. For more information see:

- Radio And Telecommunications Terminal Equipment (R&TTE) http://ec.europa.eu/enterprise/sectors/rtte/index_en.htm
- European Conference of Postal and Telecommunications Administrations (CEPT) <http://www.cept.org/>
- European Telecommunications Standards Institute (ETSI) <http://www.etsi.org/>
- European Communications Office (ECO) <http://www.cept.org/eco>

2.2. Potential Interference Sources

The radio modules operate in the unlicensed ISM band, in which there are many other applications e.g. WLAN, Bluetooth® and microwave ovens. This can cause interference that may, in certain conditions, prohibit radio communication. The user is encouraged to implement a number of channels and to alternate between those channels based on one of the below methods.

- Sense if a particular channel is clear prior to transmitting (clear channel assessment)
- Pseudo Random channel change
- Select channels with the least interference (site survey)

Some of the most common interferences are listed below.

2.2.1. WLAN

Wireless Local Area Networks (WLANs) are divided into a number of overlapping channels. Figure 3 below shows the channels used by WLAN; for the US and Canada, only channels 1-13 may be used. Predominantly, channels 1, 6 and 11 are used to achieve non-overlapping channels. The user is therefore encouraged to select a channel scheme that also has channels falling in between, or entirely outside, WLAN channels. Using a detection scheme (clear channel assessment) will enable the user to find channels with minimal interference from WLAN devices.

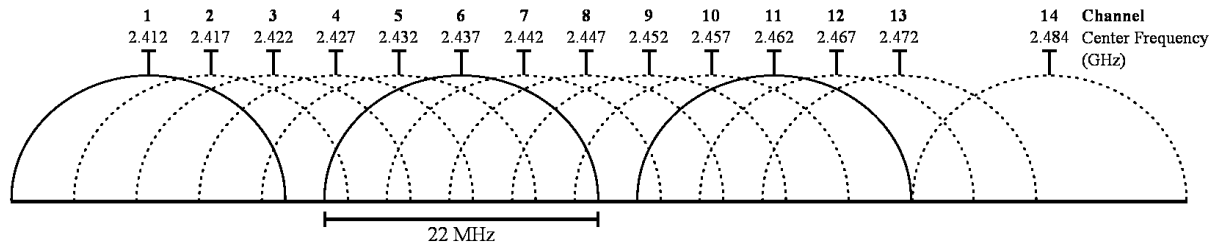

Figure 3 WLAN channels

2.2.2. Bluetooth®

Bluetooth® divides the 2.402-2.480 GHz band into 79 channels, each of which is 1MHz wide. However, since Bluetooth® changes channels rapidly (up to 1600 times a second), it is unlikely to cause continuous interference in a specific channel and can be overcome by implementing a simple acknowledge/retransmit functionality.

2.2.3. Microwave Ovens

A typical microwave oven uses a self-oscillating magnetron with a duty cycle below 50%, because the tube is completely off for half of every AC mains cycle (8.33 ms in 60 Hz countries and 10 ms in 50 Hz countries). The frequency of the microwave oven changes cyclically within each AC mains synchronized on period, and is generally not predictable.

The user is encouraged to have packet transmission durations less than half the AC mains period and implement an acknowledge/retransmit method.

2.2.4. Other Interference

Systems similar to the user’s system may also exist within range and may also be a source of interference; some typical applications to consider are:

- Alarm systems
 - These typically use low duty cycles and are therefore easy to avoid using acknowledge/retransmit methods
- Car alarms (internal motion sensors)
- Video surveillance
 - These are typically operated on a fixed channel, determined at installation time and can be avoided by using clear channel assessment. It may be useful to change the channel used by the video surveillance equipment also, if possible.

2.2.5. Time critical data

If the user requires specific time critical data throughput that cannot tolerate the delays of potentially many re-transmissions, the user is encouraged to implement an environment-aware algorithm that periodically monitors/scans the frequency band and maintain a list of “best available” channels.

2.3. Approved Usage

The A2530E24A and A2530E24C modules have been approved for use in the US, Canada and Europe. The user is encouraged to use minimum power required to establish a link, thus minimizing interference.

Changes or modifications to the module and/or operation outside the limits are prohibited and could void the user’s authority to operate the modules.

2.3.1. US and Canada

Within the US and Canada, the A2530E24A and A2530E24C modules have been approved for use as digitally modulated transmitters, for which they conform to the BW (a minimum of 500 kHz 6-dB BW for US, a maximum BW of 0.5% of the carrier frequency for Canada), power spectral density (max of 8 dBm / 3 kHz), total output power (max of 1W including the antenna gain) and spurious radiation (harmonics and others including the restricted bands) requirements.

Table 2 shows approved frequencies of operations with the corresponding maximum output power values and PA_Table register settings. These modules must be operated at or below the indicated power levels. Using the modules with higher power levels are prohibited, and will void the user’s authority to operate the modules under current FCC/IC certification.

Table 3 shows available power levels from the device along with the corresponding TXPOWER register settings. Users are encouraged to use minimum power required to establish a link, thus minimizing interference and current consumption.

Table 2 Approved Power Levels for FCC/IC

	Approved Frequencies (MHz)	Max Allowed Power (dBm)	PA_Table Value (Hex)
A2530E24A	2403 - 2479	15	0xE5
	2480	3	0x65
A2530E24C	2403 - 2478	13	0xC5
	2479	3	0x65
	2480	0	0x45

Table 3 A2530E24x module available power levels and typical current consumptions

Power (dBm)	17	15	14	13	11	9	8	6	5	3	1	0	-2	-4	-6	-9
PA_Table (Hex)	0xF5	0xE5	0xD5	0xC5	0xB5	0X5	0X95	0X85	0X75	0X65	0X55	0X45	0X35	0X25	0X15	0X05
TX Current (mA)	150	128	110	105	95	85	77	74	72	70	67	66	65	64	64	63
RX Current (mA)	28															
Idle Current(mA)	8.5															
Sleep Current, PM1 (µA)	225															
Sleep Current, PM2 (µA)	1															
Sleep Current, PM3 (µA)	0.4															

Please note that the specified current consumption numbers are for radio operation only and do not include other MCU peripherals.

2.3.2. Europe

For Europe, the maximum power is 100mW with a maximum spectral power density of 10mW/MHz. In order to meet the power spectral density requirements, the A2530E24A and A2530E24C modules should have lower output power levels.

Table 4 shows approved frequencies of operations with the maximum allowed output power values and corresponding TXPOWER register settings. Please refer to Table 3 for the available power levels from this module.

Table 4 Approved Power Levels for Europe (ETSI)

ETSI with Range Extender			
	Approved Frequencies (MHz)	Max Allowed Power (dBm)	TXPOWER Value (Hex)
A2530E24A	2403 - 2480	6	0x85
A2530E24C	2403 - 2480	5	0x75

THIS PAGE INTENTIONALLY LEFT BLANK

3. Electrical Characteristics

3.1. Absolute Maximum Ratings

Under no circumstances shall the absolute maximum ratings given in Table 5 be violated. Stress exceeding one or more of the limiting values may cause permanent damage to the device.

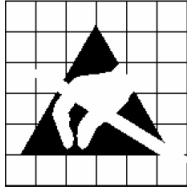

Caution!
 ESD sensitive device. Precaution should be used when handling the device in order to prevent permanent damage.



MSL 3

Caution!
 This assembly contains moisture sensitive devices and requires proper handling per IPC/JEDEC J-STD-033

Table 5 Absolute Maximum Ratings

Parameter	Min	Max	Unit	Condition/Note
Supply Voltage (Vdd)	-0.3	3.9	V	
Voltage on any digital pin	-0.3	Vdd+0.3, max 3.9	V	
RF input power		10	dBm	
Storage Temperature	-40	125	°C	
Solder reflow temperature		260	°C	According to IPC/JEDEC J-STD-020D
ESD		2	kV	According to JEDEC STD 22, method A114, Human body model
ESD		500	V	According to JEDEC STD 22, C101, Charged Device Model (CDM)

3.2. Operating Conditions

Table 6 Operating conditions

Parameter	Min	Max	Unit	Condition/Note
Supply Voltage (Vdd)	2.2	3.6	V	
Temperature Range	-40	+85	°C	

3.3. Pin Out

The A2530E24A and A2530E24C radios share a common pin-out and foot print, thus enabling the use of the same application PCB layout for US/Europe and low power (short range) versus higher power (long range).

The A2530E24x modules come with AIR-ZNP firmware loaded. Module pin-out with this firmware is customized and differs from the native module pin-out.

3.3.1. A2530E24xZ1 (Module with AIR-ZNP firmware)

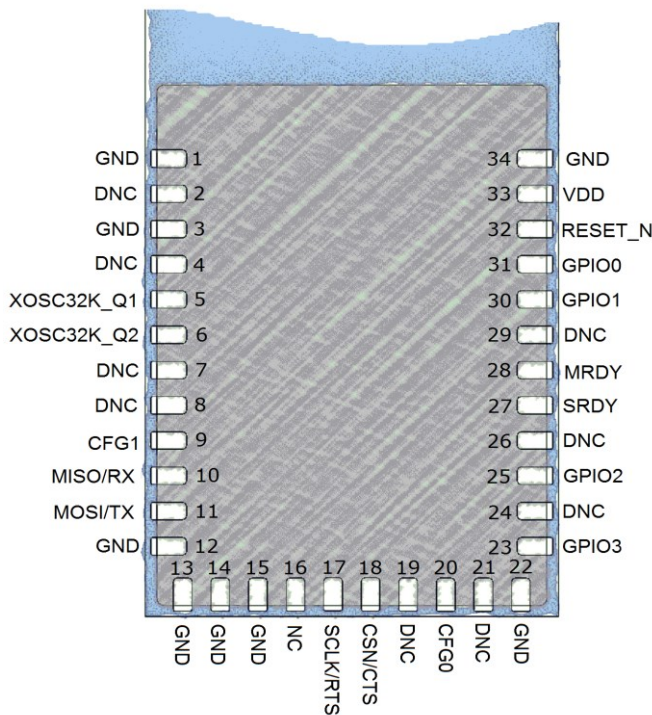

Where applicable:

NC = “No Connection”. Pin is NOT connected internally.

DNC = “Do Not Connect”. Pin reserved for internal use, ensure mating footprint pads are **isolated**.

GND = “Ground”. Connect the maximum number possible (minimum **one** for proper operation).

Figure 4 A2530E24xZ1 Module pin-out (viewed from top side)

Table 7 A2530E24xZ1 module pin descriptions with references to chip pins

Pin Number	Pin Name	Pin Type	Description	CC2530 Pin
1, 3, 12, 13, 14, 15, 22, 34	GND	Common Ground	Connect to GND	
2	DNC		Do Not Connect. Connecting this pin to anything will significantly affect the performance of the module and may void the end users right, under FCC, to operate the module	
4	DNC		Do Not Connect. Pin reserved for internal use, ensure mating footprint pads are isolated.	
5	XOSC32K_Q1	IN	Pin is set as input with pull-up resistor, however, not used by the AIR-ZNP firmware as a GPIO pin. If a 32.768kHz external crystal oscillator is connected to this pin, pin 20 (CFG0) needs to be pulled high.	32
6	XOSC32K_Q2	OUT	Pin is set as input with pull-up resistor, however, not used by the AIR-ZNP firmware as a GPIO pin. If a 32.768kHz external crystal oscillator is connected to this pin, pin 20 (CFG0) needs to be pulled high.	33
7, 8	DNC		Pins are set as input with pull-up resistors, however, not used by the AIR-ZNP firmware as GPIO pins	34, 35
9	CFG1	Digital Input	Configuration pin 1. Connect to VCC for SPI, GND for UART	36
10	MISO/RX	Digital I/O	SPI Data output/UART input	37
11	MOS/TX	Digital I/O	SPI Data input / UART output	38
16	NC		Not Internally Connected	
17	SCLK/RTS	Digital I/O	SPI Clock input / UART Request To Send output	5
18	CSN/CTS	Digital Input	SPI Slave Select active-low input / UART Clear To Send input	6
19, 21, 24	DNC		Control pins to the range extender driven by the AIR-ZNP firmware	7, 9, 12
20	CFG0	Digital Input	Configuration pin 0. Pull this pin high when using an external 32.768kHz crystal oscillator, otherwise connect to GND.	8
23	GPIO3	Digital I/O	General-purpose digital I/O pin Port 1.0. This pin defaults to an input with no internal pull-up or pull-down resistor	11
25	GPIO2	Digital I/O	General-purpose digital I/O pin Port 0.6	13
26, 29	DNC		Do Not Connect. Pins are set as input with pull-up resistors, however, not used by the AIR-ZNP firmware	14, 17
27	SRDY	Digital Output	SPI Slave Ready output	15
28	MRDY	Digital Output	SPI Master Ready output	16
30	GPIO1	Digital I/O	General-purpose digital I/O pin Port 0.1	18
31	GPIO0	Digital I/O	General-purpose digital I/O pin Port 0.0	19
32	RESET_N	Digital Input	Reset, active-low	20
33	VDD	Power (Analog)	Analog power supply connection for the Radio and PA/LNA (2.2V to 3.6V)	10,21,24,27, 28,29,31,39

3.3.2. A2530E24x (Native Module Pinout)

A module with no firmware will show the references to the native CC2530 transceiver chip and any additional functions added to it. Please note that A2530E24x modules come pre-loaded with AIR-ZNP firmware. In case the end user chooses to load his own firmware, AIR-ZNP needs to be erased first (blank module).

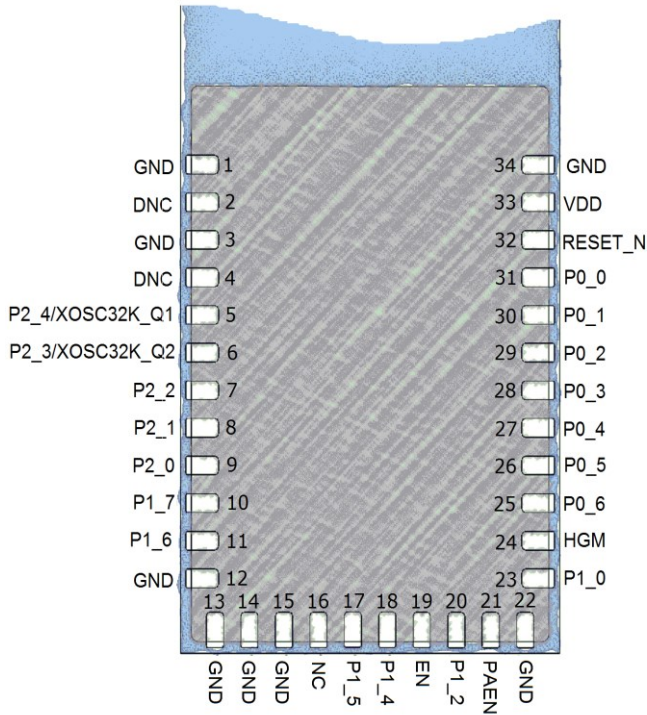

Where applicable:

NC = “No Connection”. Pin is NOT connected internally.

DNC = “Do Not Connect”. Pin reserved for internal use, ensure mating footprint pads are **isolated**.

GND = “Ground”. Connect the maximum number possible (minimum **one** for proper operation).

Figure 5 A2530E24x Module pin-out view (viewed from top side)

Table 8 A2530E24x blank module pin descriptions with references to chip pins

Pin Number	Pin Name	Pin Type	Description	CC2591 Pin	CC2530 Pin
1, 3, 12, 13, 14, 15, 16, 22, 34	GND	Common Ground	Connect to GND		
2	DNC		Do Not Connect. Connecting this pin to anything will significantly affect the performance of the module and may void the end users right, under FCC, to operate the module		
4	DNC		Do Not Connect. Pin reserved for internal use, ensure mating footprint pads are isolated.		
5	P2_4/XOSC32K_Q1	Digital I/O, Analog IO	General-purpose digital I/O pin Port 2.4. 32.768 kHz XOSC		32
6	P2_3/XOSC32K_Q2	Digital I/O	General-purpose digital I/O pin Port 2.3. 32.768 kHz XOSC		33
7 - 9	P2_2 - P2_0	Digital I/O	General-purpose digital I/O pin Port 2.2 - Port 2.0		34 - 36
10 - 11	P1_7 - P1_6	Digital I/O	General-purpose digital I/O pin Port 1.7 - Port 1.6		37 - 38
17 - 18	P1_5 - P1_4	Digital I/O	General-purpose digital I/O pin Port 1.5 - Port 1.4		5 - 6
19	EN	Digital Input	Control pin for CC2591 range extender LNA. See datasheet for details.	6	7
20	P1_2	Digital I/O	General-purpose digital I/O pin Port 1.2		8
21	PAEN	Digital Input	Control pin for CC2591 range extender PA. See datasheet for details. This pin is pulled down internally with a 76.7kΩ resistor.	5	9
23	P1_0	Digital I/O	General-purpose digital I/O pin Port 1.0		11
24	HGM	Digital Input	Control pin for CC2591 range extender receiver high gain mode. See datasheet for details. This pin is pulled up by a 100kΩ resistor.	7	12
25 - 31	P0_6 - P0_0	Digital I/O	General-purpose digital I/O pin Port 0.6 - Port 0.0		13 - 19
32	RESET_N	Digital Input	Reset, active-low		20
33	VDD	Power (Analog)	Analog power supply connection for the Radio and PA/LNA (2.2V to 3.6V)	1, 16	10,21,24,27, 28,29,31,39

3.4. Recommended Layout (dimensions in mm)

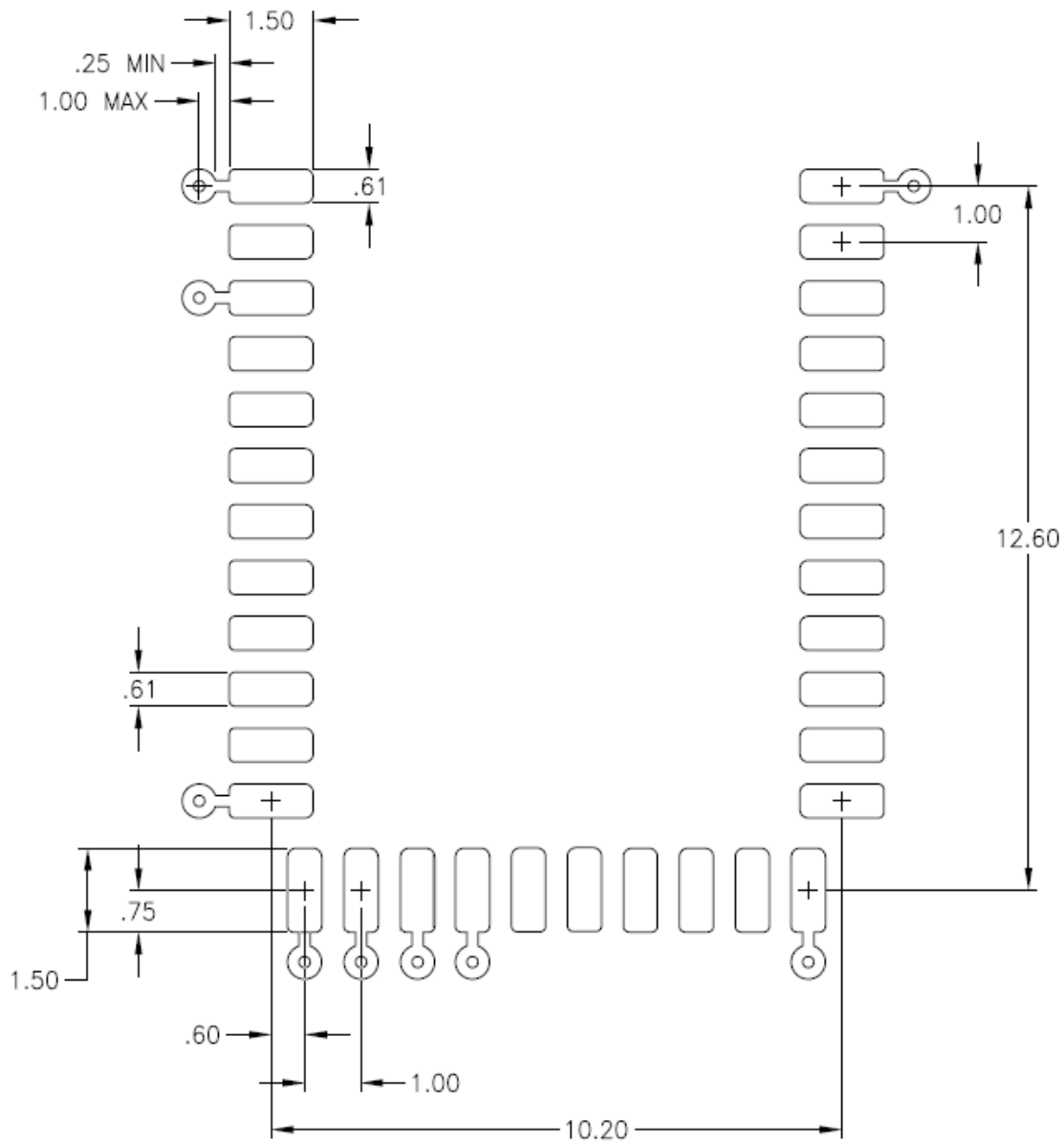

Figure 6 Recommended PCB layout.

Figure 6 shows the recommended PCB layout for the A2530E24x modules. Module pads are smaller than the recommended layout pads, and need to be aligned as shown in Figure 7.

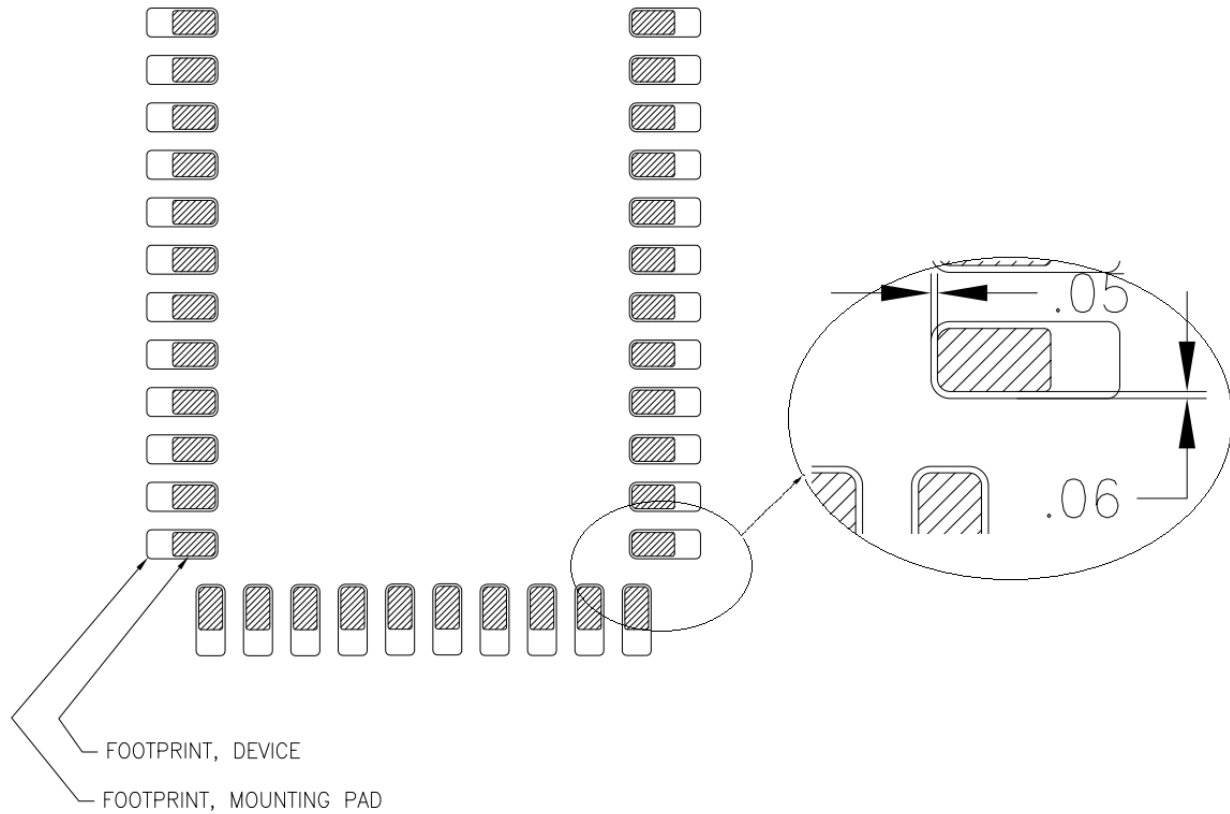

Figure 7 Module placement on the PCB mounting pads

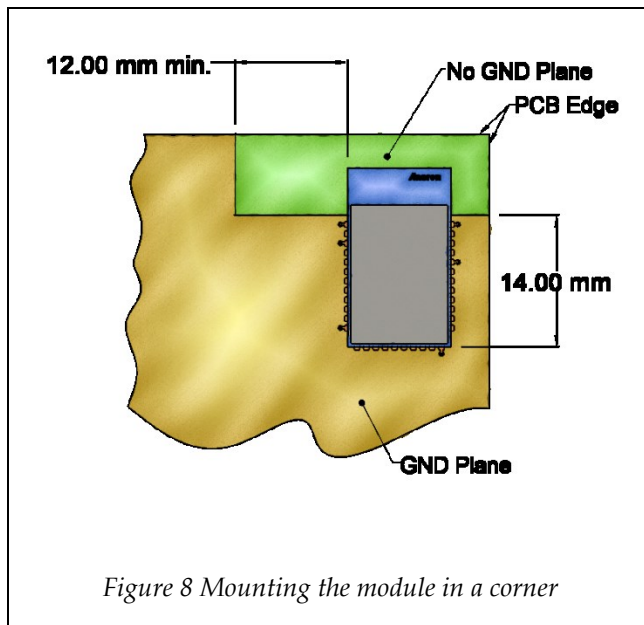

Figure 8 Mounting the module in a corner

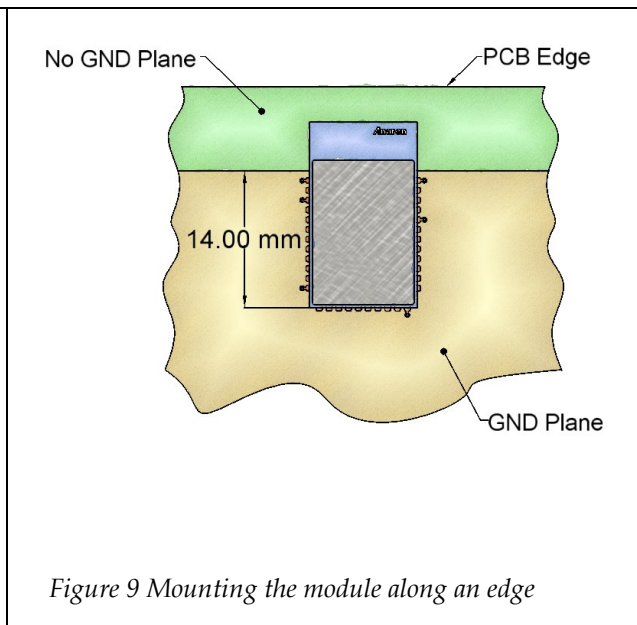

Figure 9 Mounting the module along an edge

3.5. Power Supply Considerations

Noise on the power supply line reduces the sensitivity of a receiver and can modulate onto a transmitters signal, both of which causes a degradation of link quality and hence a reduction in range.

The A2530E24A and A2530E24C modules have integral noise reduction from power supply to the internal AVDD and DVDD pins, consisting of ferrite beads and decoupling capacitances. This arrangement will take care of most supply voltage noise. For optimal performance in particular noisy environments (switching regulators, motor controls, etc.) it may be necessary to add additional noise reduction means, which can consist of a low noise LDO or additional LC filtering.

Note that if operated from a battery source there is no need for additional noise reduction. Also note that if the noise source can be synchronized to be off whenever the module is transmitting or receiving then that will also suffice.

4. Mechanical and Process

4.1. Radio Module Details (dimensions in mm)

4.1.1. A2530E24A

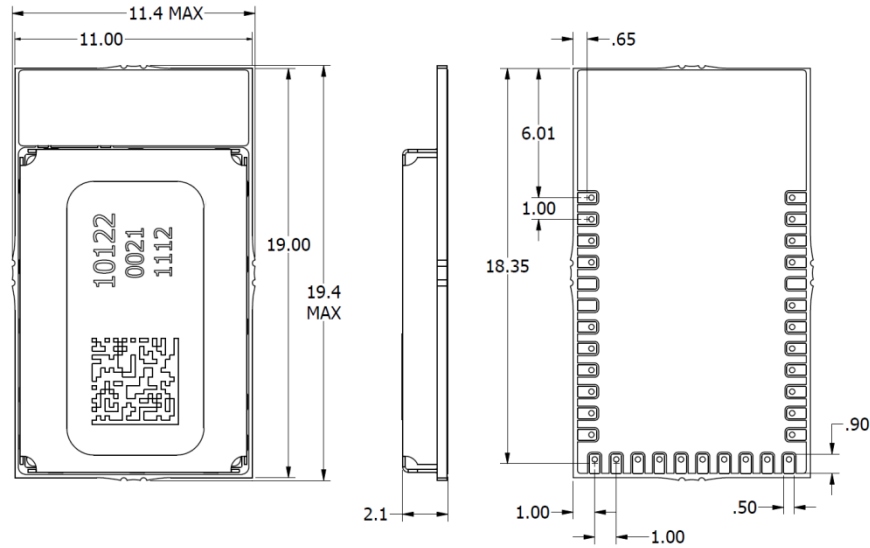

Figure 10 A2530E24A dimensions

4.1.2. A2530E24C

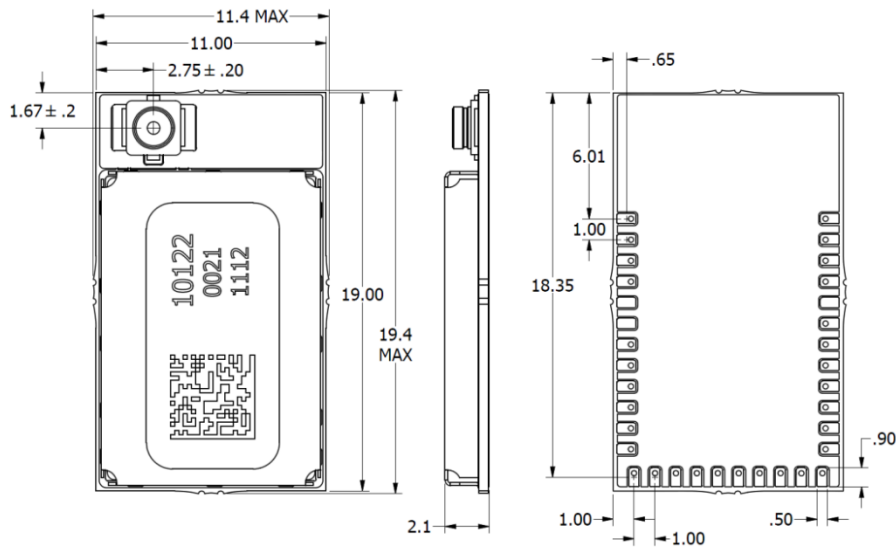

Figure 11 A2530E24C dimensions

4.2. Packaging Details (dimensions in mm)

AIR modules are available in Matrix Tray and Tape & Reel packaging for high-volume assembly. Details of packaging provided below:

4.2.1. Matrix Tray Packaging

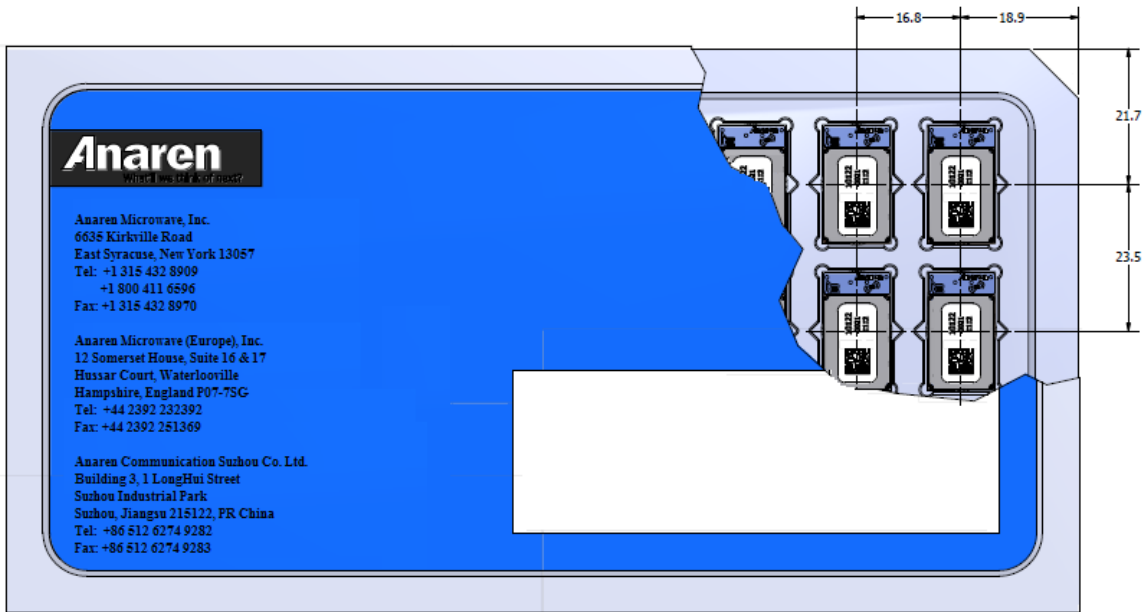

Figure 12 A2530E24A and A2530E24C Matrix Tray Packaging Detail (27/Tray)

4.2.2. Tape-Reel Packaging

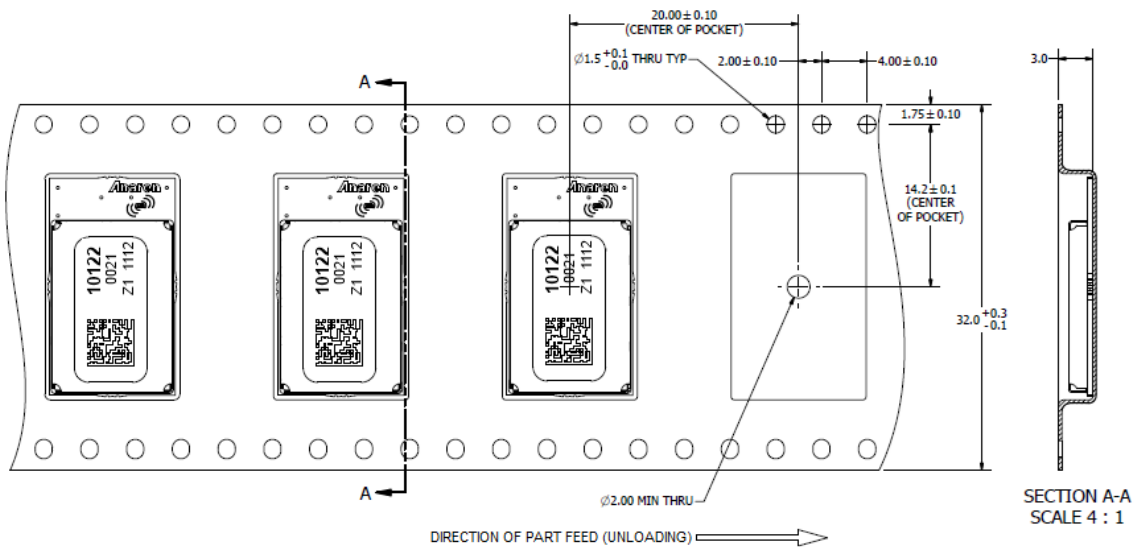

Figure 13 A2530E24A and A2530E24C Tape-Reel Packaging Detail (500/Reel)

4.3. Soldering

AIR Modules may be mounted either manually (for prototyping or low volume production), or automatically for high-volume production.

A no-clean tin/silver/copper (SAC) solder is recommended, however lead-based, no-clean pastes may also be used.

CAUTION: AIR Modules are designed for no-clean fluxes only. DO NOT use water-based fluxes that require aqueous cleaning after solder. Spot cleaning with a flux remover and toothbrush may be performed with care.

4.3.1. Manual Mounting Procedure

The recommended soldering method is reflowing of a paste solder on a hot plate. This method works provided the bottom of the board where the AIR module is to be mounted is accessible, and there are no bottom-side components in the way.

An aluminum or copper block may be placed on the hot plate surface to transfer heat to a localized area on the board where the AIR module is mounted

- Set the hot plate to the reflow temperature solder manufacturer’s recommended
- Apply solder paste to the pads on the board receiving the AIR module
- Place the AIR module carefully onto the dispensed solder
- Using tweezers or another holding device, carefully place board with AIR module onto the hot plate surface (or metal block)
- Apply heat until reflow occurs, per solder paste manufacturer’s recommendations
- Carefully remove the board and place on a heat-resistant surface to cool
- Check assembly electrically to confirm there are no opens or shorts

4.3.2. Automated Mounting Procedure

The AIR module recommended solder reflow profile is based on IPC/JEDEC J-STD-020.

Table 5-2 Classification Reflow Profiles

Profile Feature	Sn-Pb Eutectic Assembly	Pb-Free Assembly
Average ramp-up rate (T _{smax} to T _p)	3° C/second max.	3° C/second max.
Preheat		
- Temperature Min (T _{smin})	100 °C	150 °C
- Temperature Max (T _{smax})	150 °C	200 °C
- Time (T _{smin} to T _{smax}) (t _s)	60-120 seconds	60-180 seconds
Time maintained above:		
- Temperature (T _L)	183 °C	217 °C
- Time (t _L)	60-150 seconds	60-150 seconds
Peak Temperature (T _p)	See Table 4.1	See Table 4.2
Time within 5°C of actual Peak Temperature (t _p) ²	10-30 seconds	20-40 seconds
Ramp-down Rate	6 °C/second max.	6 °C/second max.
Time 25°C to Peak Temperature	6 minutes max.	8 minutes max.

Note 1: All temperatures refer to topside of the package, measured on the package body surface.

Note 2: Time within 5 °C of actual peak temperature (t_p) specified for the reflow profiles is a “supplier” minimum and “user” maximum.

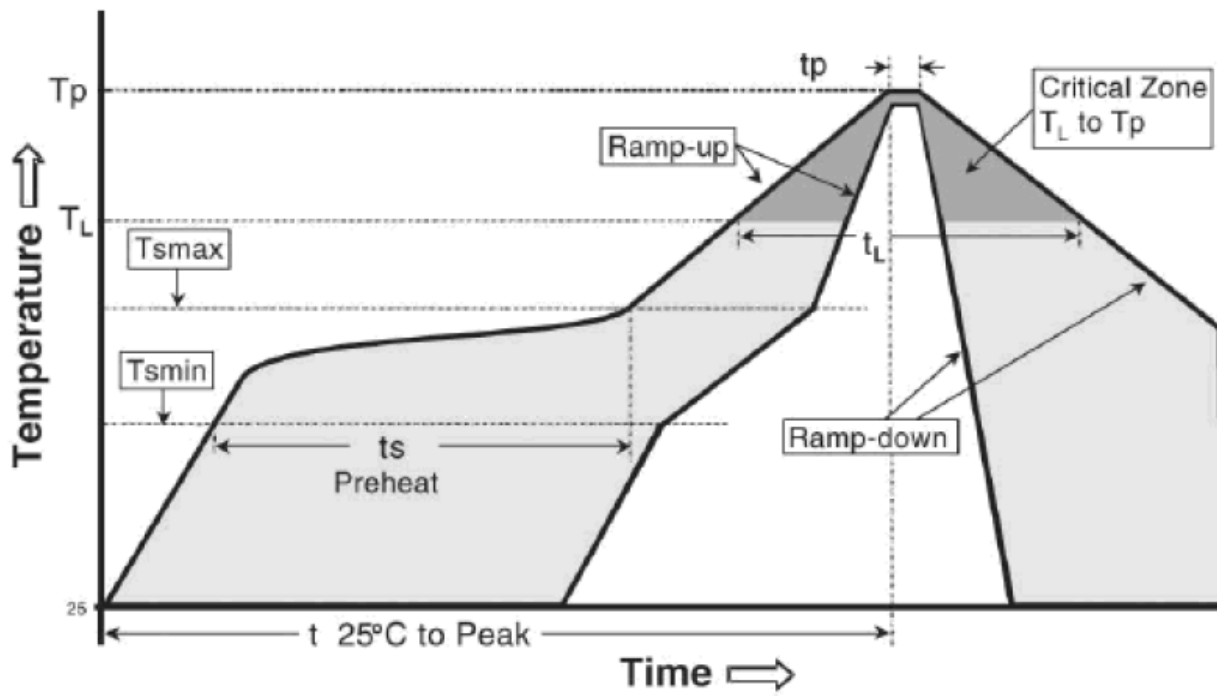

SnPb Eutectic Process - Package Peak Reflow Temperatures

Package Thickness	Volume mm³ <350	Volume mm³ ≥ 350
<2.5 mm	240 +0/-5 °C	225 +0/-5°C
≥ 2.5 mm	225 +0/-5°C	225 +0/-5°C

Pb-free Process - Package Peak Reflow Temperatures

Package Thickness	Volume mm³ < 350	Volume mm³ 350 - 2000	Volume mm³ > 2000
< 1.6 mm	260 °C *	260 °C *	260 °C *
1.6 mm - 2.5 mm	260 °C *	250 °C *	245 °C *
> 2.5 mm	250 °C *	245 °C *	245 °C *

* Tolerance: The device manufacturer/supplier shall assure process compatibility up to and including the stated classification temperature at the rated MSL level

DOCUMENT HISTORY

Date	Author	Change Note No./Notes
03/16/12	Sula	Initial Draft
03/19/12	Sula	Table 8 and section 2.1.3 updated
03/27/12	Richardson	Initial Release
04/26/12	Sula	Section 2.1.2 updated
05/03/12	Richardson	Modified Title Page and section 2.1.2.1
11/01/12	Richardson	Updated format to latest standard, updated diagrams
02/26/14	Sula	Updated pin-outs and pin descriptions. Added module current consumption
01/20/15	Sula	Updated ETSI-compliant power levels
1/23/15	Sula	Removed QR Code from the first page

THIS PAGE INTENTIONALLY LEFT BLANK

Attach distributor contact information
here

If you have additional questions, need samples, or would like a quote –
please email the AIR team at AIR@anaren.com .

For a full list of our franchised distributors, please visit our website:
<http://www.anaren.com/air/>

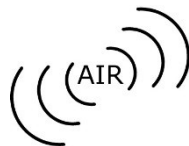

Anaren Microwave, Inc.
6635 Kirkville Road
East Syracuse, NY 13057
Tel: +1 315 432 8909
+1 800 411 6596
Fax: +1 315 432 8970

Anaren Microwave (Europe), Inc.
12 Somerset House, Suite 16 & 17
Hussar Court, Waterlooville
Hampshire, England P07-7SG
Tel: +44 2392 232392
Fax: +44 2392 251369

Anaren Communication Suzhou Co. Ltd.
Bldg 3, No. 1 LongHui Street
Suzhou Industrial Park
Suzhou 215122, PR China
Tel: +86 512 6274 9282
Fax: +86 512 6274 9283

Компания «Океан Электроники» предлагает заключение долгосрочных отношений при поставках импортных электронных компонентов на взаимовыгодных условиях!

Наши преимущества:

- Поставка оригинальных импортных электронных компонентов напрямую с производств Америки, Европы и Азии, а так же с крупнейших складов мира;
- Широкая линейка поставок активных и пассивных импортных электронных компонентов (более 30 млн. наименований);
- Поставка сложных, дефицитных, либо снятых с производства позиций;
- Оперативные сроки поставки под заказ (от 5 рабочих дней);
- Экспресс доставка в любую точку России;
- Помощь Конструкторского Отдела и консультации квалифицированных инженеров;
- Техническая поддержка проекта, помощь в подборе аналогов, поставка прототипов;
- Поставка электронных компонентов под контролем ВП;
- Система менеджмента качества сертифицирована по Международному стандарту ISO 9001;
- При необходимости вся продукция военного и аэрокосмического назначения проходит испытания и сертификацию в лаборатории (по согласованию с заказчиком);
- Поставка специализированных компонентов военного и аэрокосмического уровня качества (Xilinx, Altera, Analog Devices, Intersil, Interpoint, Microsemi, Actel, Aeroflex, Peregrine, VPT, Syfer, Eurofarad, Texas Instruments, MS Kennedy, Miteq, Cobham, E2V, MA-COM, Hittite, Mini-Circuits, General Dynamics и др.);

Компания «Океан Электроники» является официальным дистрибьютором и эксклюзивным представителем в России одного из крупнейших производителей разъемов военного и аэрокосмического назначения «JONHON», а так же официальным дистрибьютором и эксклюзивным представителем в России производителя высокотехнологичных и надежных решений для передачи СВЧ сигналов «FORSTAR».



JONHON

«JONHON» (основан в 1970 г.)

Разъемы специального, военного и аэрокосмического назначения:

(Применяются в военной, авиационной, аэрокосмической, морской, железнодорожной, горно- и нефтедобывающей отраслях промышленности)

«FORSTAR» (основан в 1998 г.)

ВЧ соединители, коаксиальные кабели, кабельные сборки и микроволновые компоненты:

(Применяются в телекоммуникациях гражданского и специального назначения, в средствах связи, РЛС, а так же военной, авиационной и аэрокосмической отраслях промышленности).



Телефон: 8 (812) 309-75-97 (многоканальный)

Факс: 8 (812) 320-03-32

Электронная почта: ocean@oceanchips.ru

Web: <http://oceanchips.ru/>

Адрес: 198099, г. Санкт-Петербург, ул. Калинина, д. 2, корп. 4, лит. А