

## Features

- High Life Cycle
- High Temperature Capability
- Linear Position Sensor
- IP65 Dust Proof, Water Proof (Intense Spray)
- Fiberglass Substrate
- 3M Pressure Sensitive Adhesive (PSA)
- Upon Request
  - Male or Female Nicomatic Connectors
  - Wiper of 1-3 Newton Force to Actuate Part
  - Contactless Options Available



## Mechanical Specifications

- Life Cycle: >10 million
- Height:  $\leq 0.51\text{mm}$  (0.020")
- Actuation Force (with a 10mm wide active cavity):
  - 40°C 3.0 to 5.0 N
  - 25°C 2.0 to 5.0 N
  - +23°C 0.8 to 2.0 N
  - +85°C 0.7 to 1.8 N

## Environmental Specifications

- Operating Temperature: -40°C to +85°C
- Humidity: No affect @ 95% RH, 24hrs 60°C
- IP Rating of Active Area: IP65

## Electrical Specifications

- Resistance - Standard: 10k Ohms (lengths >300mm = 20k Ohms)
- Resistance - Custom: 5k to 100k Ohms
- Resistance Tolerance:  $\pm 20\%$
- Effective Electrical Travel: 10 to 1200mm
- Linearity (Independent): Linear  $\pm 1\%$  or  $\pm 3\%$   
Rotary  $\pm 3\%$  or  $\pm 5\%$
- Repeatability: No hysteresis, but with any wiper looseness some hysteresis will occur
- Power Rating (depending on size, varies with length and temperature): 1 Watt max. @ 25°C,  $\leq 0.5$  Watt recommended
- Resolution: Analog output theoretically infinite; affected by variation of contact wiper surface area.
- Dielectric Value: No affect @ 500VAC for 1 minute

## Dimensional Diagram - Stock Linear HotPots

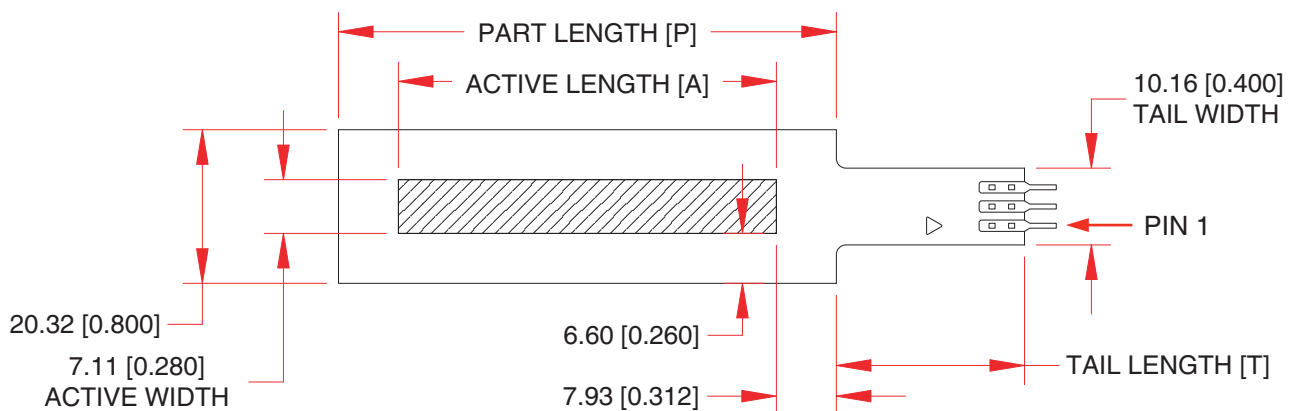

A	12.50mm 0.492"	25.00mm 0.984"	50.00mm 1.969"	100.00mm 3.937"	150.00mm 5.906"	170.00mm 6.693"	200.00mm 7.874"	300.00mm 11.811"	400.00mm 15.748"	500.00mm 19.685"	750.00mm 29.528"	1000.00mm 39.370"
P	28.36mm 1.117"	40.86mm 1.609"	65.86mm 2.593"	115.86mm 4.562"	165.86mm 6.531"	185.86mm 7.318"	215.86mm 8.499"	315.86mm 12.436"	415.86mm 16.373"	515.86mm 20.310"	765.86mm 30.153"	1015.86mm 39.995"
T	12.70mm 0.500"		24.89mm 0.980"									

## Electrical Schematic

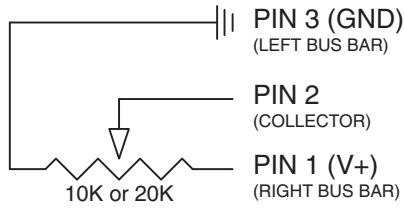

## Material Cross-Section

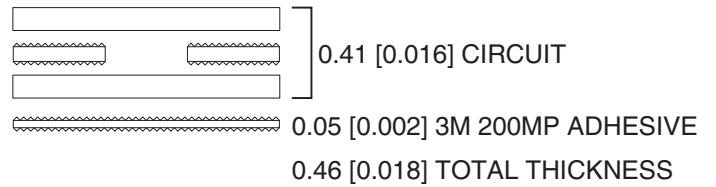

## How to Order - Linear HotPots

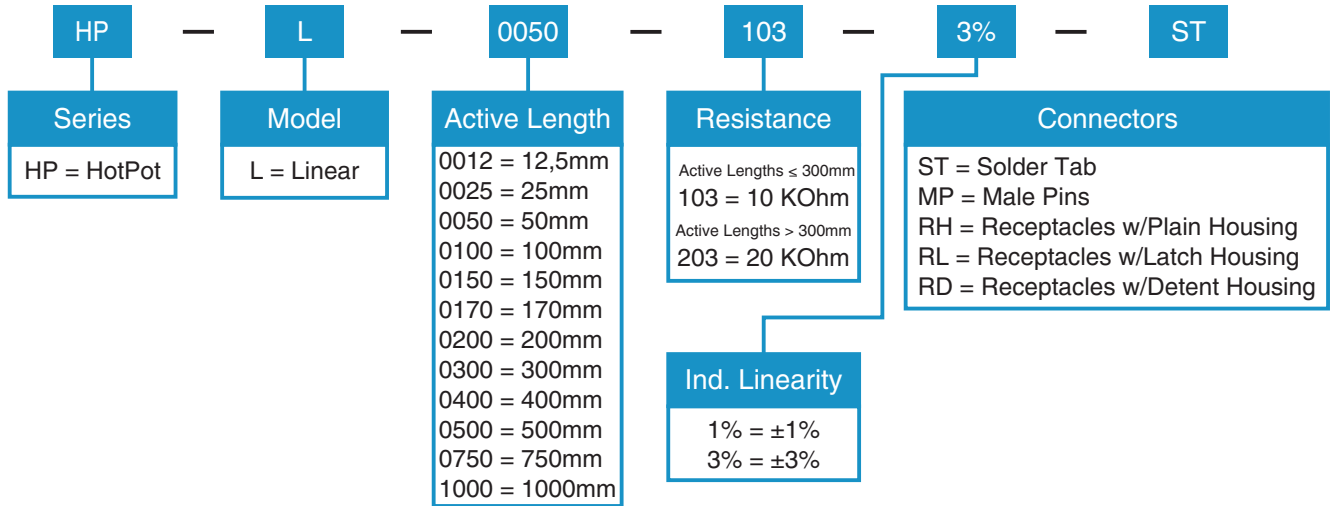

## Standard Connector Options

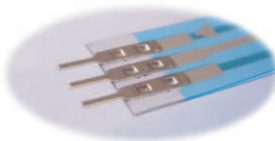

Crimflex Solder Tab (ST)

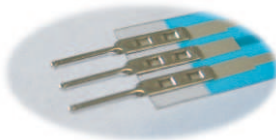

Crimflex Short Male Pins (MP)

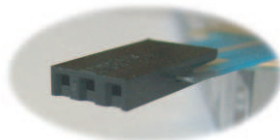

Crimflex Female Receptacles with a Plain Housing (RH)



Crimflex Female Receptacles with a Latch Housing (RL)

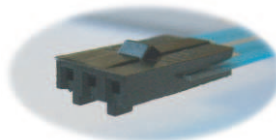

Crimflex Female Receptacles with a Detent Housing (RD)

## Customization

Customize the size, shape, and even the number of tracks. Such custom requests, for example, can be: multiple ganged sensors (up to 40 tracks); serpentine active area track; custom lengths 10mm-2000mm; custom rotary diameters, etc. Feel free to contact Spectra Symbol with your custom request at [sales@spectrasymbol.com](mailto:sales@spectrasymbol.com) or (888)795-2283..

## How It Works

In simple terms, the HotPot membrane potentiometer is a resistive element, which comprises a conductive resistor, a sealed encasement and a simple wiper assembly. A membrane potentiometer can also function as a voltage divider.

The HotPot is a three-wire system with two resistive output channels and an electrical collector channel.



By pressing a wiper down onto the top circuit the HotPot produces the desired electrical output. The "wiper" is a non-conductive mechanism that depresses the top circuit actuating the potentiometer from the outside of the element. The top and bottom circuits are separated by 0.15mm (0.006") of spacer adhesive build-up and contact between the circuit occurs by pressure (usually 1-3 Newtons) from the wiper on the top circuit, pushing down until the top circuit connects with the bottom circuit to create a potentiometric output.



The construction of the wiper design can adapt to any application because most materials can serve as the wiper: plastics, metals, sliders, rollers, wheels, etc. Also, the HotPot can also be manually (hand) actuated.

## Wiper

Typical wiper materials are delrin, plastic injection molded products, metal rollers with back-loaded springs, sliders attached to lead-screws, etc. With small quantities, an off-the-shelf solution might be easier, while with higher quantities or space limitations a custom wiper may be required.

The stock 1-3 Newton wiper is an excellent product for most applications. In case of unique applications, extreme environment or cycle needs, it is recommended to seek the advice of the Spectra Symbol Design Department. The selection of the correct wiper (material, form) can affect the life cycle and electrical output of the SoftPot.

## Stock Wiper

### Mechanical Specifications

- Minimum Force: 1 Newton
- Maximum Force: 3 Newtons
- Tip Material: Delrin
- Thread Pitch: M6 (1mm)



### Dimensional Diagram

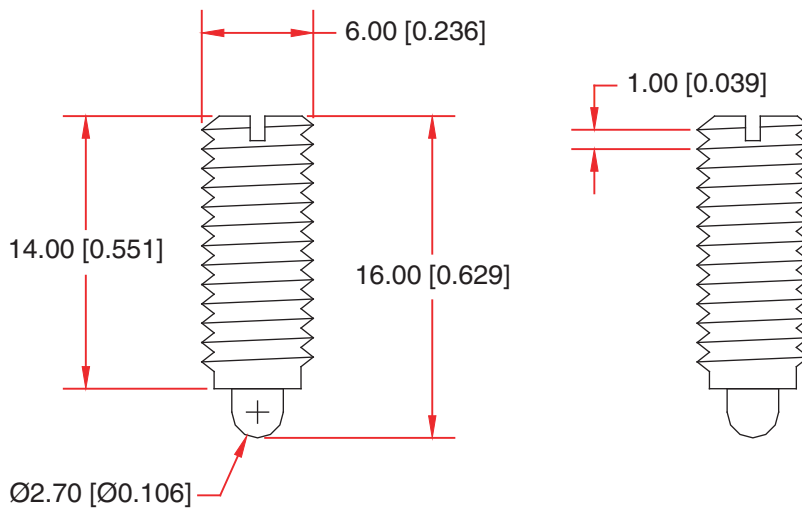

### How to Order - Stock Wiper

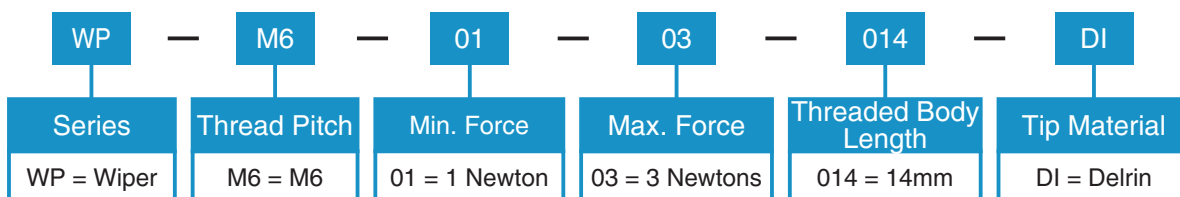
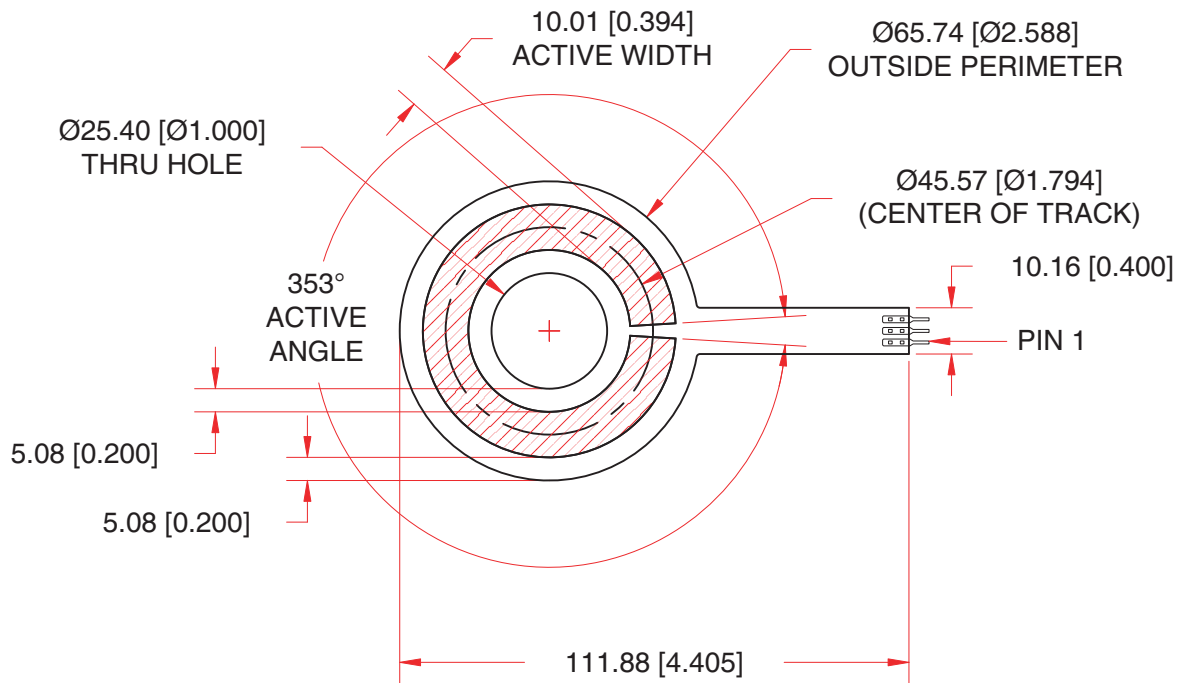
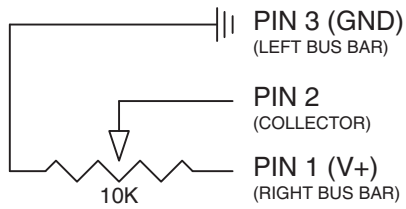

Diagram - Stock Rotary HotPot



Electrical Schematic



Material Cross-Section

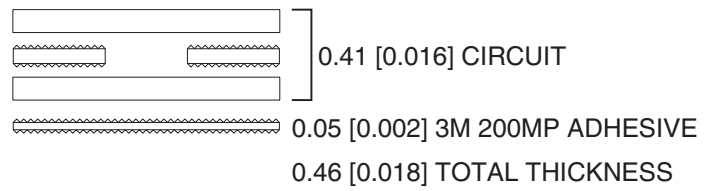

How to Order - Rotary HotPot

HP	-	R	-	0046	/	0353	-	103	-	5%	-	ST
Series		Model		Center of Active Track		Active Angle		Resistance		Connectors		
HP = HotPot		R = Rotary		0046 = 45.57mm		0353 = 353°		103 = 10 KOhm		ST = Solder Tab MP = Male Pins RH = Receptacles w/Plain Housing RL = Receptacles w/Latch Housing RD = Receptacles w/Detent Housing		
								Ind. Linearity				
								3% = ±3%				
								5% = ±5%				

Компания «Океан Электроники» предлагает заключение долгосрочных отношений при поставках импортных электронных компонентов на взаимовыгодных условиях!

Наши преимущества:

- Поставка оригинальных импортных электронных компонентов напрямую с производств Америки, Европы и Азии, а так же с крупнейших складов мира;
- Широкая линейка поставок активных и пассивных импортных электронных компонентов (более 30 млн. наименований);
- Поставка сложных, дефицитных, либо снятых с производства позиций;
- Оперативные сроки поставки под заказ (от 5 рабочих дней);
- Экспресс доставка в любую точку России;
- Помощь Конструкторского Отдела и консультации квалифицированных инженеров;
- Техническая поддержка проекта, помощь в подборе аналогов, поставка прототипов;
- Поставка электронных компонентов под контролем ВП;
- Система менеджмента качества сертифицирована по Международному стандарту ISO 9001;
- При необходимости вся продукция военного и аэрокосмического назначения проходит испытания и сертификацию в лаборатории (по согласованию с заказчиком);
- Поставка специализированных компонентов военного и аэрокосмического уровня качества (Xilinx, Altera, Analog Devices, Intersil, Interpoint, Microsemi, Actel, Aeroflex, Peregrine, VPT, Syfer, Eurofarad, Texas Instruments, MS Kennedy, Miteq, Cobham, E2V, MA-COM, Hittite, Mini-Circuits, General Dynamics и др.);

Компания «Океан Электроники» является официальным дистрибьютором и эксклюзивным представителем в России одного из крупнейших производителей разъемов военного и аэрокосмического назначения «JONHON», а так же официальным дистрибьютором и эксклюзивным представителем в России производителя высокотехнологичных и надежных решений для передачи СВЧ сигналов «FORSTAR».



## JONHON

«JONHON» (основан в 1970 г.)

Разъемы специального, военного и аэрокосмического назначения:

(Применяются в военной, авиационной, аэрокосмической, морской, железнодорожной, горно- и нефтедобывающей отраслях промышленности)

«FORSTAR» (основан в 1998 г.)

ВЧ соединители, коаксиальные кабели,  
кабельные сборки и микроволновые компоненты:

(Применяются в телекоммуникациях гражданского и специального назначения, в средствах связи, РЛС, а так же военной, авиационной и аэрокосмической отраслях промышленности).



Телефон: 8 (812) 309-75-97 (многоканальный)

Факс: 8 (812) 320-03-32

Электронная почта: [ocean@oceanchips.ru](mailto:ocean@oceanchips.ru)

Web: <http://oceanchips.ru/>

Адрес: 198099, г. Санкт-Петербург, ул. Калинина, д. 2, корп. 4, лит. А