

GT17 Series

— Multi contacts connector for high frequency Application —
(as USB, LVDS, GVIF)



■ Features

- All surface shielded construction.
- Ideal for use as Automotive USB connectors.

■ Applications

In-car data communications, etc.

F Connectors

● Center Terminals
(Used with 6, 8, and 10 conductor cable)

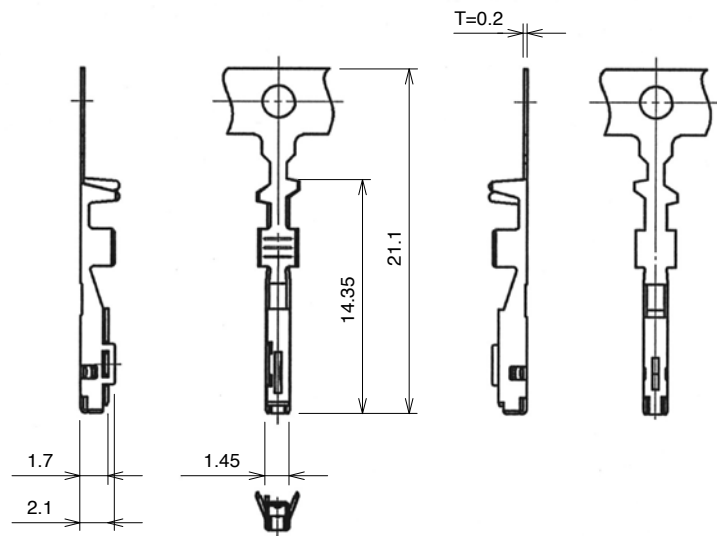

These are lead-free products.

Part Number	HRS No.	Material	Finish	Conductor Size (AWG)	Outer Diameter	Packaging	RoHS
GT17-2022SCF	767-0009-0	Copper alloy	Tin plating	#20 to 22	φ 1.1 to 1.3 mm	10,000 pcs/reel	YES
GT17-2428SCF	767-0010-0	Copper alloy	Tin plating	#24 to 28	φ 0.7 to 1.0 mm	10,000 pcs/reel	
GT17-30SCF	767-0064-9	Copper alloy	Tin plating	#30	φ 1.1 to 1.3 mm	10,000 pcs/reel	
GT17B-2428SCF	767-0122-3	Copper alloy	Tin plating	#24 to 28	φ 0.5 to 0.7 mm	10,000 pcs/reel	

M Connectors

● Center Terminals
(Used with 6, 8, and 10 conductor cable)



These are lead-free products.



Part Number	HRS No.	Material	Finish	Conductor Size (AWG)	Outer Diameter	Packaging	RoHS
GT17-2022PCF	767-0082-0	Brass	Tin plating	AWG#20~22	φ 1.1 to 1.3 mm	10,000 pcs/reel	YES
GT17-2428PCF	767-0076-8	Brass	Tin plating	AWG#24~28	φ 0.7 to 1.0 mm	10,000 pcs/reel	
GT17A-2428PCF	767-0121-0	Brass	Tin plating	AWG#24~28	φ 1.1 to 1.3 mm	10,000 pcs/reel	

6-Conductor Straight Connectors

◆By using each of the two differently keyed types of housing for different purposes, incorrect insertion can be prevented.



◆The product comprises 6 parts.

(Housing, insulator, outer terminal, shield plate, retainer, and center terminal)

●Housing

Part Number	HRS No.	Material / Finish or Color	Packaging	Remarks	RoHS
GT17VS-6DS-HU	767-0051-7	PBT/Light Gray	1piece	—	YES
GT17VSA-6DS-HU	767-0052-0	PBT/Black	1piece	—	

●Insulator

Part Number	HRS No.	Material / Finish or Color	Packaging	Remarks	RoHS
GT17V-6DS-2C	767-0026-0	PBT/Dark Gray	1piece	—	YES

●Outer terminal

Part Number	HRS No.	Material / Finish or Color	Packaging	Remarks	RoHS
GT17VS-6DS-5CF	767-0050-4	Copper alloy / Tin plating	1piece	Lead free, Conductor Size ϕ 4.8 to 5.2	YES

●Shield plate

Part Number	HRS No.	Material / Finish or Color	Packaging	Remarks	RoHS
GT17VS-6DS-SC	767-0049-5	Copper alloy / Tin plating	1piece	Lead free	YES

●Retainer

Part Number	HRS No.	Material / Finish or Color	Packaging	Remarks	RoHS
GT17VS-6DS-R	767-0053-2	PBT/Dark Gray	1piece	—	YES

●Center terminal

Used with 6,8, and 10 conductor cable

◆Mating Table

Color	Cable side connector	Board connector
Gray	GT17VS-6DS-HU	GT17V-6DP-DS(70)
		GT17VB-6DP-DS(70)
Black	GT17VSA-6DS-HU	GT17VA-6DP-DS(70)
		GT17VC-6DP-DS(70)

6-Conductor Right-angle Connectors

By using each of the two differently keyed types of housing for different purposes, incorrect insertion can be prevented.

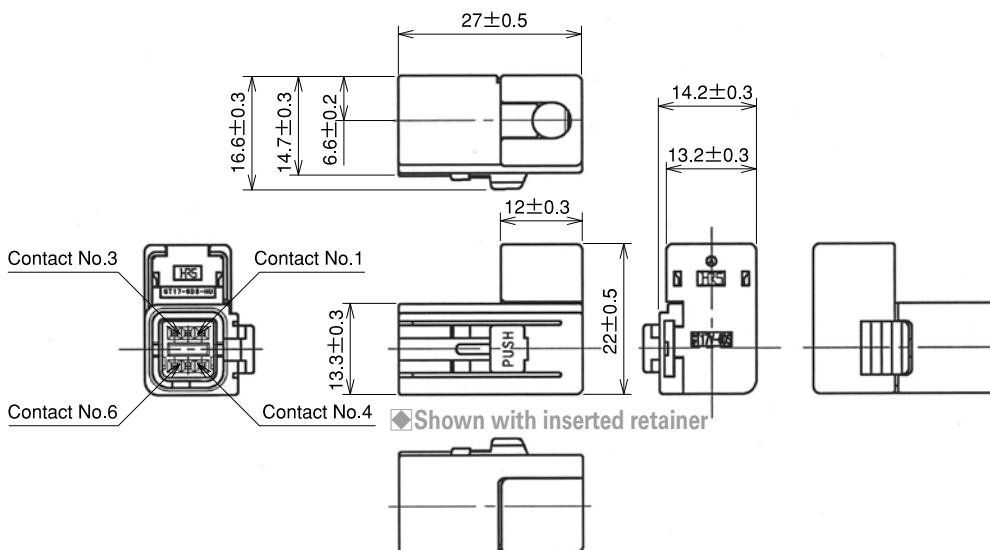

Shown with inserted retainer

The product comprises 6 parts.

(Housing, insulator, outer terminal, shield plate, retainer, and center terminal)

● Housing

Part Number	HRS No.	Material / Finish or Color	Packaging	Remarks	RoHS
GT17V-6DS-HU	767-0029-8	PBT / Light Gray	1piece	—	YES
GT17VA-6DS-HU	767-0030-7	PBT / Black	1piece	—	

● Insulator

Part Number	HRS No.	Material / Finish or Color	Packaging	Remarks	RoHS
GT17V-6DS-2C	767-0026-0	PBT / Dark Gray	1piece	—	YES

● Outer terminal

Part Number	HRS No.	Material / Finish or Color	Packaging	Remarks	RoHS
GT17V-6DS-5CF	767-0027-2	Copper alloy / Tin plating	1piece	Lead free, Conductor Size ϕ 4.8 to 5.2mm	YES
GT17V-6DS-3.8CF	767-0075-5	Copper alloy / Tin plating	1piece	Lead free, Conductor Size ϕ 3.8 to 4.2mm	

● Shield plate

Part Number	HRS No.	Material / Finish or Color	Packaging	Remarks	RoHS
GT17V-6DS-SC	767-0028-5	Copper alloy / Tin plating	1piece	Lead free	YES

● Retainer

Part Number	HRS No.	Material / Finish or Color	Packaging	Remarks	RoHS
GT17V-6DS-R	767-0031-0	PBT / Dark Gray	1piece	—	YES

● Center terminal

Used with 6, 8, and 10 conductor cable

◆ Mating Table

Color	Cable side connector	Board connector
Gray	GT17V-6DS-HU	GT17V-6DP-DS(70)(Cable exit direction, up side from mounting side)
		GT17VB-6DP-DS(70)(Cable exit direction, down side from mounting side)
Black	GT17VA-6DS-HU	GT17VA-6DP-DS(70)(Cable exit direction, up side from mounting side)
		GT17VC-6DP-DS(70)(Cable exit direction, down side from mounting side)

6-Conductor Printed Circuit Board Connectors

By using each of the two differently keyed types of housing for different purposes, incorrect insertion can be prevented.

● Cable extraction facing up

Part Number	HRS No.	Material / Finish or Color	Packaging	Remarks	RoHS
GT17V-6DP-DS(70)	767-0024-4-70	Housing: PBT/Light Gray Center terminal: Brass /Tin plating Outer terminal: Copper alloy /Tin plating	1piece	Lead free	YES



GT17V-6DP-DS(70)



● Cable extraction facing down

Part Number	HRS No.	Material / Finish or Color	Packaging	Remarks	RoHS
GT17VB-6DP-DS(70)	767-0032-2-70	Housing: PBT/Light Gray Center terminal: Brass /Tin plating Outer terminal: Copper alloy /Tin plating	1piece	Lead free	YES



GT17VB-6DP-DS(70)



6-Conductor Printed Circuit Board Connectors

By using each of the two differently keyed types of housing for different purposes, incorrect insertion can be prevented.

● Cable extraction facing up

Part Number	HRS No.	Material / Finish or Color	Packaging	Remarks	RoHS
GT17VA-6DP-DS(70)	767-0025-7-70	Housing: PBT/Black Center terminal: Brass /Tin plating Outer terminal: Copper alloy /Tin plating	1piece	Lead free	YES



GT17VA-6DP-DS(70)



● Cable extraction facing down

Part Number	HRS No.	Material / Finish or Color	Packaging	Remarks	RoHS
GT17VC-6DP-DS(70)	767-0033-5-70	Housing: PBT/Black Center terminal: Brass /Tin plating Outer terminal: Copper alloy /Tin plating	1piece	Lead free	YES



GT17VC-6DP-DS(70)



GT 5
GT 13
GT 16
PO5G
GT 11
GT 17
GT 19
GT 26
GT 27
GT 3
GT 6W
GT 7
GT 10
GT 18W
GT 15
GT 8
GT 9
GT 25
GT 22

Coaxial cable connection of Antennas, Sensors, and Communication Trunk Lines

6-Conductor Inline Connectors

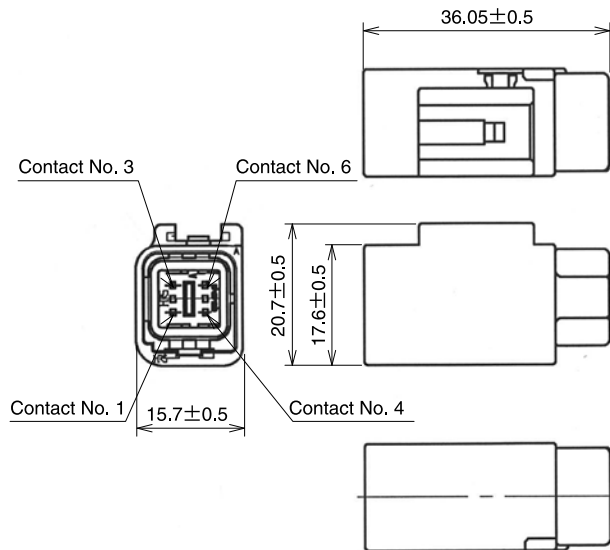

GT17VSN-6DP-HU



GT17VSV-6DP-HU



◆The product comprises 6 parts.
(Housing, insulator, outer terminal, shield plate, retainer, and center terminal)

●Housing

Part Number	HRS No.	Material / Finish or Color	Packaging	Remarks	RoHS
GT17VSN-6DP-HU	767-0077-0	PBT / Light Gray	1piece	—	—
GT17VSV-6DP-HU	767-0128-0	PBT / Light Gray	1piece	—	YES

●Insulator

Part Number	HRS No.	Material / Finish or Color	Packaging	Remarks	RoHS
GT17V-6DP-2C	767-0078-3	PBT / Dark Gray	1piece	—	YES

●Outer terminal

Part Number	HRS No.	Material / Finish or Color	Packaging	Remarks	RoHS
GT17VS-6DP-5CF	767-0080-5	Copper alloy / Tin plating	1piece	Lead free, Conductor Size ϕ 4.8 to 5.2mm	YES

●Shield plate

Part Number	HRS No.	Material / Finish or Color	Packaging	Remarks	RoHS
GT17VS-6DP-SC	767-0079-6	Copper alloy / Tin plating	1piece	Lead free	YES

●Retainer

Part Number	HRS No.	Material / Finish or Color	Packaging	Remarks	RoHS
GT17VS-6DP-R	767-0081-8	PBT / Dark Gray	1piece	—	YES

●Center terminal

Used with 6,8, and 10 conductor cable

GT17 6-Conductor Inline Connector Mounting Condition

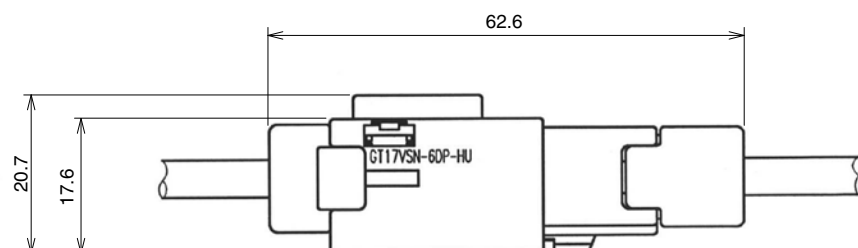

8-Conductor Right-angle Connectors

◆By using each of the two differently keyed types of housing for different purposes, incorrect insertion can be prevented.



◆The product comprises 6 parts.

(Housing, insulator, outer terminal, shield plate, retainer, and center terminal)

●Housing

Part Number	HRS No.	Material / Finish or Color	Packaging	Remarks	RoHS
GT17-8DS-HU	767-0003-4	PBT / Light Gray	1piece	—	YES
GT17A-8DS-HU	767-0004-7	PBT / Black	1piece	—	

●Insulator

Part Number	HRS No.	Material / Finish or Color	Packaging	Remarks	RoHS
GT17-8DS-2C	767-0005-0	PBT / Dark Gray	1piece	—	YES

●Outer terminal

Part Number	HRS No.	Material / Finish or Color	Packaging	Remarks	RoHS
GT17-8DS-7CF(70)	767-0007-5-70	Phosphor bronze / Tin plating	1piece	Lead free, Conductor Size ϕ 6.8 to 7.2mm	YES

●Shield plate

Part Number	HRS No.	Material / Finish or Color	Packaging	Remarks	RoHS
GT17-8DS-SC(70)	767-0006-2-70	Copper alloy / Tin plating	1piece	Lead free	YES

●Retainer

Part Number	HRS No.	Material / Finish or Color	Packaging	Remarks	RoHS
GT17-8DS-R	767-0008-8	PBT / Dark Gray	1piece	—	YES

●Center terminal

Used with 6, 8, and 10 conductor cable

◆Mating Table

Color	Cable side connector	Board connector
Gray	GT17-8DS-HU	GT17V-8DP-DS(Cable exit direction, up side from mounting side)
		GT17VB-8DP-DS(Cable exit direction, down side from mounting side)
Black	GT17A-8DS-HU	GT17VA-8DP-DS(Cable exit direction, up side from mounting side)
		GT17VC-8DP-DS(Cable exit direction, down side from mounting side)

8-Conductor Straight Connectors

By using each of the two differently keyed types of housing for different purposes, incorrect insertion can be prevented.



The product comprises 6 parts.
(Housing, insulator, outer terminal, shield plate, retainer, and center terminal)

● Housing

Part Number	HRS No.	Material / Finish or Color	Packaging	Remarks	RoHS
GT17S-8DS-HU	767-0108-2	PBT / Light Gray	1piece	—	YES
GT17SA-8DS-HU	767-0109-5	PBT / Black	1piece	—	

● Insulator

Part Number	HRS No.	Material / Finish or Color	Packaging	Remarks	RoHS
GT17-8DS-2C	767-0005-0	PBT / Dark Gray	1piece	—	YES

● Outer terminal

Part Number	HRS No.	Material / Finish or Color	Packaging	Remarks	RoHS
GT17S-8DS-7CF	767-0106-7	Copper alloy / Tin plating	1piece	Lead free, Conductor Size ϕ 6.8 to 7.2mm	YES

● Shield plate

Part Number	HRS No.	Material / Finish or Color	Packaging	Remarks	RoHS
GT17S-8DS-SC	767-0107-0	Copper alloy / Tin plating	1piece	Lead free	YES

● Retainer

Part Number	HRS No.	Material / Finish or Color	Packaging	Remarks	RoHS
GT17S-8DS-R	767-0110-4	PBT / Dark Gray	1piece	—	YES

● Center terminal

Used with 6,8, and 10 conductor cable

◆ Mating Table

Color	Cable side connector	Board connector
Gray	GT17S-8DS-HU	GT17V-8DP-DS(Cable exit direction, up side from mounting side)
		GT17VB-8DP-DS(Cable exit direction, down side from mounting side)
Black	GT17SA-8DS-HU	GT17VA-8DP-DS(Cable exit direction, up side from mounting side)
		GT17VC-8DP-DS(Cable exit direction, down side from mounting side)

8-Conductor Printed Circuit Board Connectors

● Cable extraction facing up

Part Number	HRS No.	Material / Finish or Color	Packaging	Remarks	RoHS
GT17V-8DP-DS	767-0139-6	Housing: PBT/Light Gray Center terminal: Brass /Tin plating Outer terminal: Copper alloy /Tin plating	1piece	Lead free	YES



GT17V-8DP-DS



● Cable extraction facing down

Part Number	HRS No.	Material / Finish or Color	Packaging	Remarks	RoHS
GT17VB-8DP-DS	767-0185-3	Housing: PBT/Light Gray Center terminal: Brass /Tin plating Outer terminal: Copper alloy /Tin plating	1piece	Lead free	YES
GT17VB-8DP-DS-SB	767-0123-6	Housing: PBT/Light Gray Center terminal/Shield case: Brass /Tin plating Outer terminal: Copper alloy /Tin plating	1piece	Lead free	



GT17VB-8DP-DS



GT17VB-8DP-DS-SB
(with enhanced shielding type)



GT 5
GT 13
GT 16
PO5G
GT 11
GT 17
GT 19
GT 26
GT 27
GT 3
GT 6W
GT 7
GT 10
GT 18W
GT 15
GT 8
GT 9
GT 25
GT 22

Coaxial cable connection of Antennas, Sensors, and Communication Trunk Lines

8-Conductor Printed Circuit Board Connectors

● Cable extraction facing up

Part Number	HRS No.	Material / Finish or Color	Packaging	Remarks	RoHS
GT17VA-8DP-DS	767-0200-5	Housing: PBT/Black Center terminal: Brass /Tin plating Outer terminal: Copper alloy /Tin plating	1piece	Lead free	YES



GT17VA-8DP-DS



● Cable extraction facing down

Part Number	HRS No.	Material / Finish or Color	Packaging	Remarks	RoHS
GT17VC-8DP-DS	767-0199-8	Housing: PBT/Black Center terminal: Brass /Tin plating Outer terminal: Copper alloy /Tin plating	1piece	Lead free	YES



GT17VC-8DP-DS



10-Conductor Right-angle Connectors

◆By using each of the two differently keyed types of housing for different purposes, incorrect insertion can be prevented.



◆The product comprises 6 parts.

(Housing, insulator, outer terminal, shield plate, retainer, and center terminal)

●Housing

Part Number	HRS No.	Material / Finish or Color	Packaging	Remarks	RoHS
GT17V-10DS-HU	767-0039-1	PBT / Light Gray	1piece	—	—
GT17VA-10DS-HU	767-0040-0	PBT / Black	1piece	—	YES

●Insulator

Part Number	HRS No.	Material / Finish or Color	Packaging	Remarks	RoHS
GT17V-10DS-2C	767-0036-3	PBT / Dark Gray	1piece	—	YES

●Outer terminal

Part Number	HRS No.	Material / Finish or Color	Packaging	Remarks	RoHS
GT17V-10DS-8CF	767-0037-6	Copper alloy / Tin plating	1piece	Lead free, Conductor Size 7.5 to 8.0mm	YES

●Shield plate

Part Number	HRS No.	Material / Finish or Color	Packaging	Remarks	RoHS
GT17V-10DS-SC	767-0038-9	Copper alloy / Tin plating	1piece	Lead free	YES

●Retainer

Part Number	HRS No.	Material / Finish or Color	Packaging	Remarks	RoHS
GT17V-10DS-R	767-0041-3	PBT / Dark Gray	1piece	—	YES

●Center terminal

Used with 6, 8, and 10 conductor cable

◆Mating Table

Color	Cable side connector	Board connector
Gray	GT17V-10DS-HU	GT17V-10DP-DS(70)(Cable exit direction, up side from mounting side)
		GT17V-10DP-DSA(70)(straight DIP type)
		GT17V-10DP-DS-SB(70)(Cable exit direction, up side from mounting side)
Black	GT17VA-10DS-HU	GT17VA-10DP-DS(70)(Cable exit direction, up side from mounting side)
		GT17VA-10DP-DSA(70)(straight DIP type)
		GT17VA-10DP-DS-SB(70)(Cable exit direction, up side from mounting side)

10-Conductor Straight Connectors

◆By using each of the two differently keyed types of housing for different purposes, incorrect insertion can be prevented.



◆The product comprises 6 parts.

(Housing, insulator, outer terminal, shield plate, retainer, and center terminal)

● Housing

Part Number	HRS No.	Material / Finish or Color	Packaging	Remarks	RoHS
GT17VS-10DS-HU	767-0061-0	PBT / Light Gray	1piece	—	YES
GT17VSA-10DS-HU	767-0062-3	PBT / Black	1piece	—	

● Insulator

Part Number	HRS No.	Material / Finish or Color	Packaging	Remarks	RoHS
GT17V-10DS-2C	767-0036-3	PBT / Dark Gray	1piece	—	YES

● Outer terminal

Part Number	HRS No.	Material / Finish or Color	Packaging	Remarks	RoHS
GT17VS-10DS-8CF	767-0059-9	Copper alloy / Tin plating	1piece	Lead free, Conductor Size 7.5 to 8.0mm	YES

● Shield plate

Part Number	HRS No.	Material / Finish or Color	Packaging	Remarks	RoHS
GT17VS-10DS-SC	767-0060-8	Copper alloy / Tin plating	1piece	Lead free	YES

● Retainer

Part Number	HRS No.	Material / Finish or Color	Packaging	Remarks	RoHS
GT17VS-10DS-R	767-0063-6	PBT / Dark Gray	1piece	—	YES

● Center terminal

Used with 6,8, and 10 conductor cable

◆ Mating Table

Color	Cable side connector	Boad connector
Gray	GT17VS-10DS-HU	GT17V-10DP-DS(70)
		GT17V-10DP-DSA(70)
		GT17V-10DP-DS-SB(70)
Black	GT17VSA-10DS-HU	GT17VA-10DP-DS(70)
		GT17VA-10DP-DSA(70)
		GT17VA-10DP-DS-SB(70)

10-Conductor Printed Circuit Board Connectors

◆By using each of the two differently keyed types of housing for different purposes, incorrect insertion can be prevented.

●Right-angle type

Part Number	HRS No.	Material / Finish or Color	Packaging	Remarks	RoHS
GT17V-10DP-DS(70)	767-0034-8-70	Housing: PBT/Light Gray Center terminal: Brass /Tin plating Outer tube terminal: Copper alloy /Tin plating	1piece	—	YES
GT17V-10DP-DS-SB(70)	767-0069-2-70	Housing: PBT/Light Gray Center terminal/Shield case: Brass /Tin plating Outer tube terminal: Copper alloy /Tin plating	1piece	Products with enhanced shielding	



GT17V-10DP-DS(70)

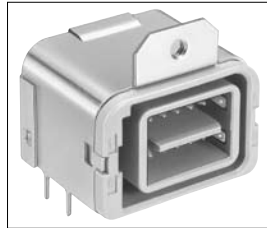

GT17V-10DP-DS-SB(70)

(with enhanced shielding type)

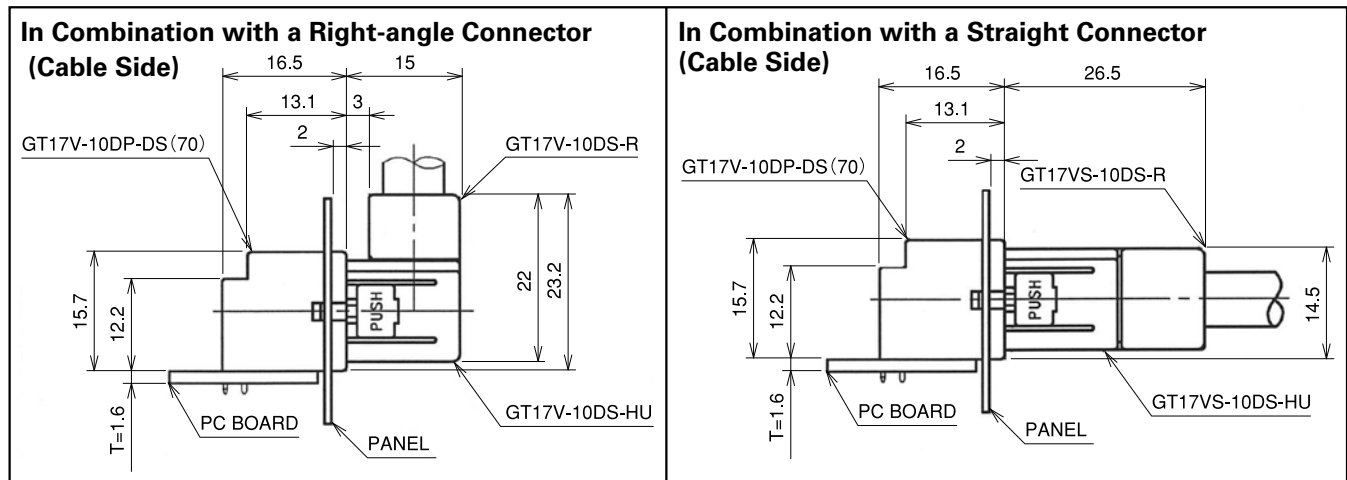

●Straight-type

Part Number	HRS No.	Material / Finish or Color	Packaging	Remarks	RoHS
GT17V-10DP-DSA(70)	767-0067-7-70	Housing: PBT/Black Center terminal: Brass /Tin plating Outer terminal: Copper alloy /Tin plating	1piece	—	YES
GT17V-10DP-DSA-SB	767-0154-0	Housing: PBT/Black Center terminal: Brass /Tin plating Outer terminal: Copper alloy /Tin plating	1piece	—	

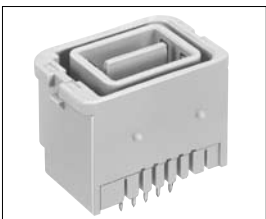

GT17V-10DP-DSA(70)



(with enhanced shielding type)

GT17V-10DP-DSA-SB

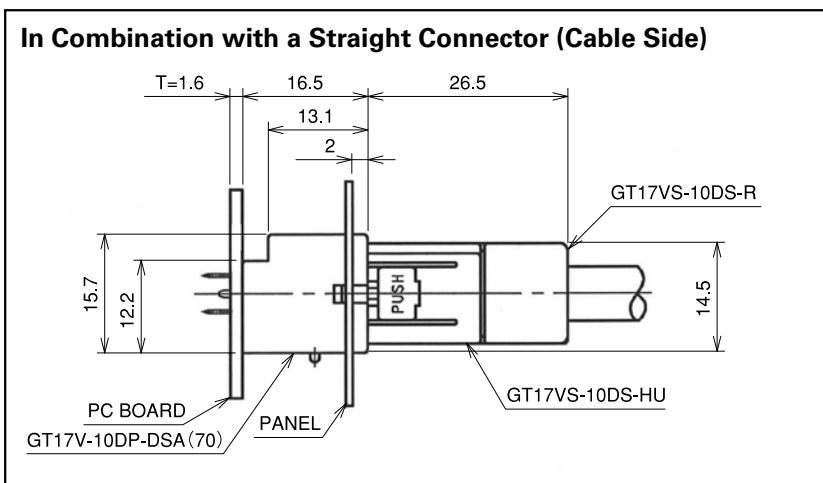

10-Conductor Printed Circuit Board Connectors

By using each of the two differently keyed types of housing for different purposes, incorrect insertion can be prevented.

● Right-angle type

Part Number	HRS No.	Material / Finish or Color	Packaging	Remarks	RoHS
GT17VA-10DP-DS(70)	767-0035-0-70	Housing: PBT/Black Center terminal: Brass /Tin plating Outer terminal: Copper alloy /Tin plating	1piece	—	YES
GT17VA-10DP-DS-SB(70)	767-0070-1-70	Housing: PBT/Black Center terminal/Shield case: Brass /Tin plating Outer terminal: Copper alloy /Tin plating	1piece	Products with enhanced shielding	



GT17VA-10DP-DS(70)



GT17VA-10DP-DS-SB(70)

(with enhanced shielding type)

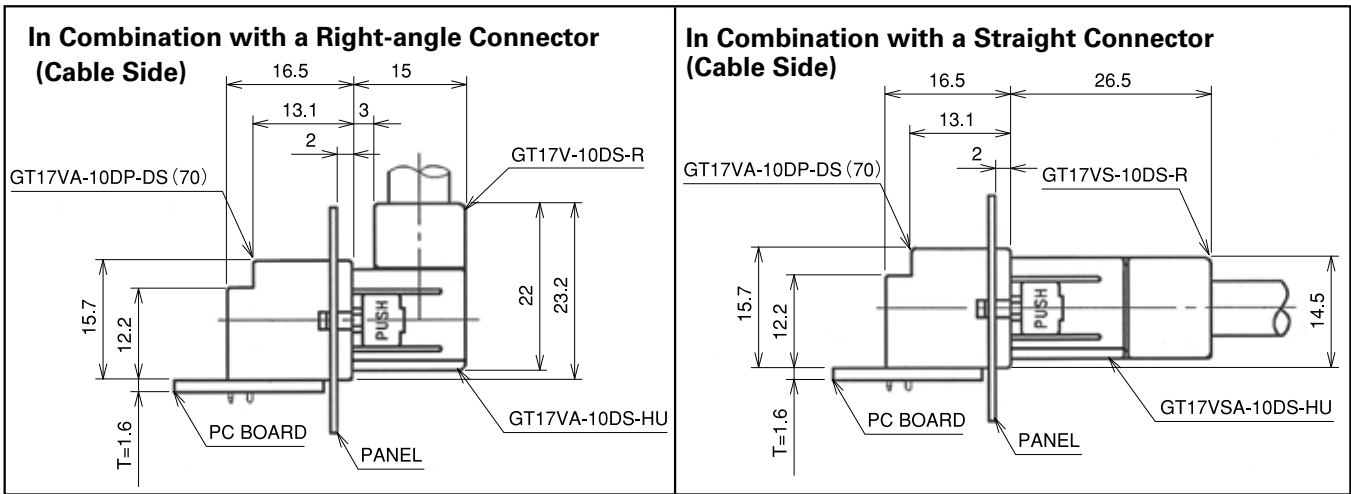

● Straight-type

Part Number	HRS No.	Material / Finish or Color	Packaging	Remarks	RoHS
GT17V-10DP-DSA(70)	767-0067-0-70	Housing: PBT/Black Center terminal: Brass /Tin plating Outer terminal: Copper alloy /Tin plating	1piece	—	YES
GT17V-10DP-DSA-SB	767-0154-0-00	Housing: PBT/Black Center terminal/Shield case: Brass /Tin plating Outer terminal: Copper alloy /Tin plating	1piece	—	



GT17VA-10DP-DSA(70)



(with enhanced shielding type)

GT17VA-10DP-DSA-SB



10-Conductor Inline Connectors



◆The product comprises 6 parts.
(Housing, insulator case, outer terminal, shield plate, retainer, and center terminal)

●Housing

Part Number	HRS No.	Material / Finish or Color	Packaging	Remarks	RoHS
GT17VSN-10DP-HU	767-0115-8	PBT / Light Gray	1piece	—	YES

●Insulator

Part Number	HRS No.	Material / Finish or Color	Packaging	Remarks	RoHS
GT17V-10DP-2C	767-0112-0	PBT / Dark Gray	1piece	—	YES

●Outer terminal

Part Number	HRS No.	Material / Finish or Color	Packaging	Remarks	RoHS
GT17VS-10DP-5.2CF	767-0114-5	Copper alloy / Tin plating	1,224pcs/pack	Lead free	YES
GT17VS-10DP-8CF	767-0130-1	Copper alloy / Tin plating	1,224pcs/pack	Lead free	

●Shield plate

Part Number	HRS No.	Material / Finish or Color	Packaging	Remarks	RoHS
GT17VS-10DP-SC	767-0113-2	Copper alloy / Tin plating	1,224pcs/pack	Lead free	YES

●Retainer

Part Number	HRS No.	Material / Finish or Color	Packaging	Remarks	RoHS
GT17VS-10DP-5.2R	767-0111-7	PBT / Dark Gray	1piece	—	YES
GT17VS-10DP-8R	767-0131-4	PBT / Dark Gray	1piece	—	

●Center terminal

Used with 6,8, and 10 conductor cable

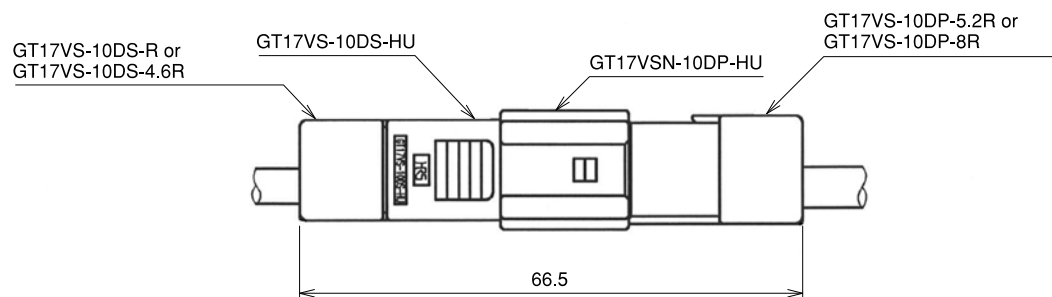

◆Fully mated connector assemblies

GT 5
 GT 13
 GT 16
 POSG
 GT 11
GT 17
 GT 19
 GT 26
 GT 27
 GT 3
 GT 6W
 GT 7
 GT 10
 GT 18W
 GT 15
 GT 8
 GT 9
 GT 25
 GT 22

Coaxial cable connection of Antennas, Sensors, and Communication Trunk Lines

◆Wirina Method

① Strip the Jacket.

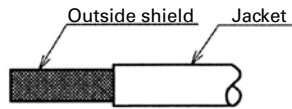

② Cut the shield and intermediate material to expose the wire and braid.

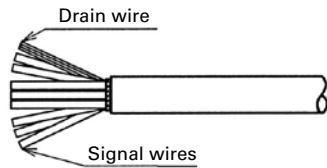

③ Bend back the drain wire over the Jacket.

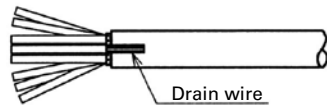

④ Wrap with conductive tape.

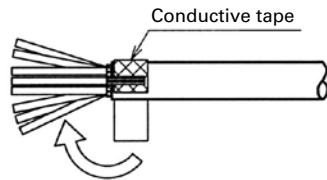

⑤ Strip the wire leads.

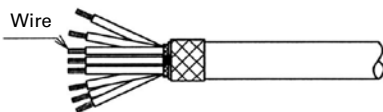

⑥ Crimp the center terminals.

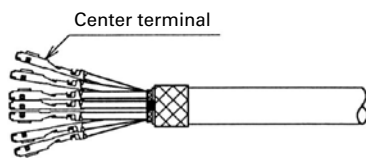

⑦ Insert the center terminals into the insulator.

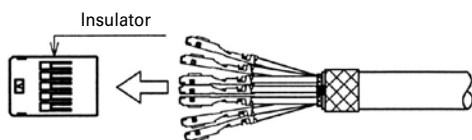

GT17V-10DS-HU Harness Finish

⑧ Insert the insulator into the Outer terminal.

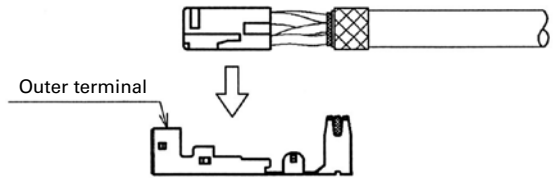

⑨ Insert the Shield Cover.

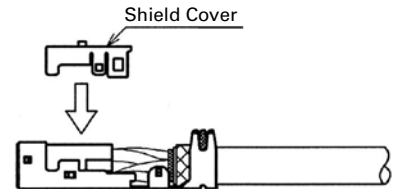

⑩ Fold back the Outer terminal.

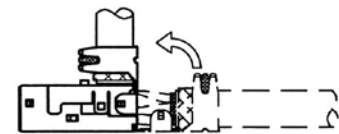

⑪ Crimp the Outer terminal.

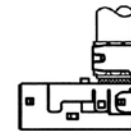

⑫ Insert the Outer terminal into the housing.

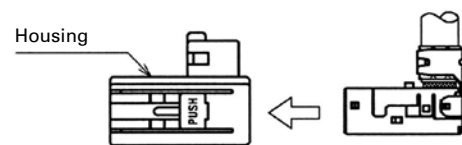

⑬ Insert the retainer.



⑭ Completion

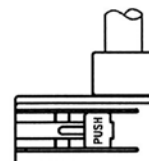

*Crimp height setting tables are available for each cable type. Please contact your nearest Hirose Electric account representative. Different cables will require different crimp height settings.

GT17VS-10DS-HU Harness Finish

- ⑧ Insert the insulator into the Outer terminal.



- ⑨ Crimp the Outer terminal.



- ⑩ Insert the Shield Cover.



- ⑪ Insert the Outer terminal into the housing.



- ⑫ Insert the retainer.

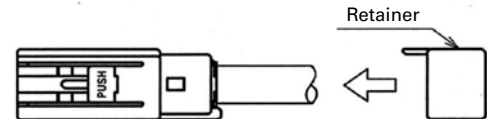

- ⑬ Completion



GT 5

GT 13

GT 16

PO5G

GT 11

GT 17

GT 19

GT 26

GT 27

GT 3

GT 6W

GT 7

GT 10

GT 18W

GT 15

GT 8

GT 9

GT 25

GT 22

6-Conductor In-line Type (Waterproof Type)

F Connectors



◆The product comprises 6 parts.
(Housing, insulator, outer terminal, shield plate, and center terminal)

●Housing

Part Number	HRS No.	Material / Finish or Color	Packaging	RoHS
GT17W-6S-HU	767-0214-0	PBT / Light Gray	1piece	YES

●Insulator

Part Number	HRS No.	Material / Finish or Color	Packaging	RoHS
GT17V-6DS-2C	767-0026-0	PBT / Dark Gray	1piece	YES

●Outer terminal

Part Number	HRS No.	Material / Finish or Color	Packaging	RoHS
GT17VS-6DS-5CF	767-0050-4	Copper alloy /Tin plating	1piece	YES

●Shield plate

Part Number	HRS No.	Material / Finish or Color	Packaging	RoHS
GT17VS-6DS-SC	767-0049-5	Copper alloy /Tin plating	1piece	YES

●Shield plate

Part Number	HRS No.	Material / Finish or Color	Packaging	RoHS
GT17W-1P/S-R	767-0216-5	PBT / Dark Gray Silicon/Whight	1piece	YES

●Center terminal

Used with 6,8 and 10.

M Connectors

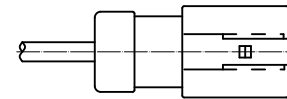
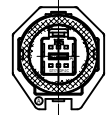
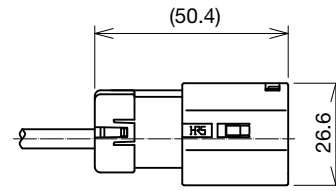
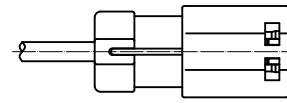

◆The product comprises 6 parts.

(Housing, insulator, outer terminal, shield plate, and center terminal)

●Housing

Part Number	HRS No.	Material / Finish or Color	Packaging	RoHS
GT17W-6PP/HU	767-0215-2	PBT / Light Gray Silicon/Whight	1piece	YES

●Insulator

Part Number	HRS No.	Material / Finish or Color	Packaging	RoHS
GT17V-6DP-2C	767-0078-3	PBT / Dark Gray	1piece	YES

●Outer terminal

Part Number	HRS No.	Material / Finish or Color	Packaging	RoHS
GT17VS-6DP-5CF	767-0080-5	Copper alloy /Tin plating	1piece	YES

●Shield plate

Part Number	HRS No.	Material / Finish or Color	Packaging	RoHS
GT17VS-6DP-SC	767-0079-6	Copper alloy /Tin plating	1piece	YES

●Shield plate

Part Number	HRS No.	Material / Finish or Color	Packaging	RoHS
GT17W-1P/S-R	767-0216-5	PBT / Dark Gray Silicon/Whight	1piece	YES

●Center terminal

Used with 6,8 and 10.

GT 5

GT 13

GT 16

PO5G

GT 11

GT 17

GT 19

GT 26

GT 27

GT 3

GT 6W

GT 7

GT 10

GT 18W

GT 15

GT 8

GT 9

GT 25

GT 22

4-Conductor Right-angle Connector(1 Row type)



Key variation



◆The product comprises 5 parts.
(Housing, insulator, outer terminal, retainer, center terminal)

●Housing

Part Number	HRS No.	Material / Finish or Color	Packaging	Remarks	RoHS
GT17H-4S-HU	767-0085-9	PBT / Dark Gray	1piece	—	YES

●Insulator

Part Number	HRS No.	Material / Finish or Color	Packaging	Remarks	RoHS
GT17H-4S-2C	767-0084-6	PBT / Light Gray	1piece	—	YES
GT17H-4S-2C(A)	767-0167-1	PBT / Brown	1piece		
GT17H-4S-2C(B)	767-0168-4	PBT / Green	1piece		
GT17H-4S-2C(C)	767-0169-7	PBT /Blue	1piece		

●Outer terminal

Part Number	HRS No.	Material / Finish or Color	Packaging	Remarks	RoHS
GT17H-4S-5CF	767-0027-2	Copper alloy /Tin plating	1piece	—	YES

●Retainer

Part Number	HRS No.	Material / Finish or Color	Packaging	Remarks	RoHS
GT17H-4S-R	767-0086-1	PBT / Dark Gray	1piece	—	YES

●Center terminal

Part Number	HRS No.	Material / Finish or Color	Conductor Size(AWG)	Remarks	RoHS
GT8-2428SCF(70)	758-0001-8-70	Phosphor Bronze /Tin plating	#24 to #28	10,000 pcs/reel	YES

◆Mating Table

Color	Cable side connector	Board connectors		
		SMT Type	DIP Type	
			Angle Type	Straight Type
Gray	GT17H-4S-ASSY	GT17H-4P-2H	GT17H-4P-2DS	GT17H-4P-2DSA
Brown	GT17H-4S-ASSY(Key TypeA)	GT17H-4P-2H(A)	GT17H-4P-2DS(A)	GT17H-4P-2DSA(A)
Green	GT17H-4S-ASSY(Key TypeB)	GT17H-4P-2H(B)	GT17H-4P-2DS(B)	GT17H-4P-2DSA(B)
Blue	GT17H-4S-ASSY(Key TypeC)	GT17H-4P-2H(C)	GT17H-4P-2DS(C)	GT17H-4P-2DSA(C)

◆ Wiring Method (4-Conductor Right-angle 1 Row Type)

① Strip Jacket.

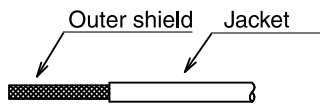

② Turn Outer shield to Backward.



③ Cover the cable by conductive tape.



④ Cut extra outer shield.



⑤ Strip Jacket.



⑥ Crimp the terminal.

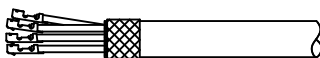

⑦ Insert terminal to the insulator.

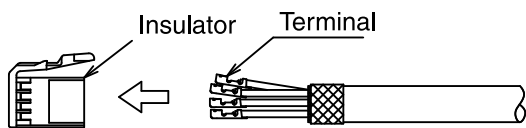

⑧



⑨ Bent the outer tube terminal 90.



⑩ Crimp the outer tube terminal.



⑪ Insert the assembled outer tube terminal to the housing.

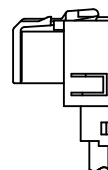

⑫ Set the Retainer.

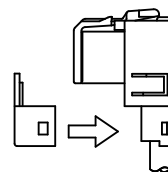

* Concerning the crimp height of terminals, crimp height settings have been prepared for each type of cable. Please contact a Hirose Electric account representative for further information.
Please note that new crimp height settings will be made for new cables and that this might take several days.
terminal insertion jig(GT17-45/PR-MD)

GT 5
GT 13
GT 16
PO5G
GT 11
GT 17
GT 19
GT 26
GT 27
GT 3
GT 6W
GT 7
GT 10
GT 18W
GT 15
GT 8
GT 9
GT 25
GT 22

Coaxial cable connection of Antennas, Sensors, and Communication Trunk Lines

4-Conductor Straight Connectors (1 Row type)

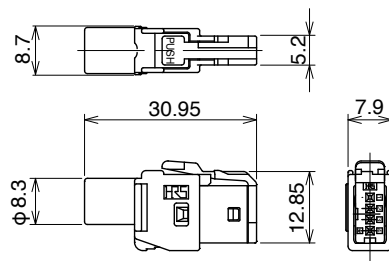

Key variation

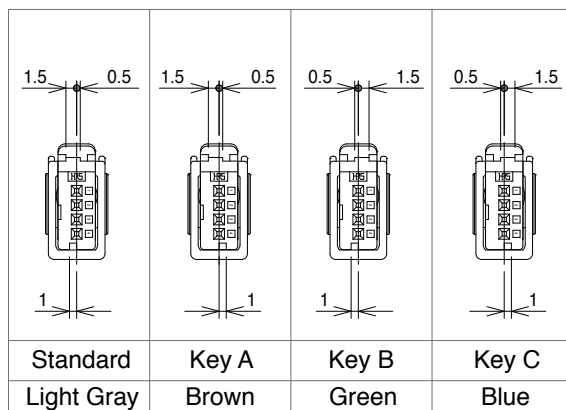

◆The product comprises 4 parts.
(Housing, insulator, outer terminal, center terminal)

●Housing

Part Number	HRS No.	Material / Finish or Color	Packaging	RoHS
GT17HS-4S-HU	767-0133-0	PBT / Dark Gray	1piece	YES

●Insulator

Part Number	HRS No.	Material / Finish or Color	Packaging	RoHS
GT17H-4S-2C	767-0084-6	PBT / Light Gray	1piece	YES
GT17H-4S-2C(A)	767-0167-1	PBT / Brown	1piece	
GT17H-4S-2C(B)	767-0168-4	PBT / Green	1piece	
GT17H-4S-2C(C)	767-0169-7	PBT /Blue	1piece	

●Outer terminal

Part Number	HRS No.	Material / Finish or Color	Packaging	RoHS
GT17HS-4S-5CF	767-0135-5	Copper alloy /Tin plating	1piece	YES

●Center terminal

Part Number	HRS No.	Material / Finish or Color	Conductor Size(AWG)	Remarks	RoHS
GT8-2428SCF(70)	758-0001-8-70	Phosphor Bronze /Tin plating	#24 to #28	10,000 pcs/reel	YES

◆Mating Table

Color	Cable side connector	Board connector		
		SMT Type	DIPType	
			Angle Type	Straight Type
Gray	GT17H-4S-ASSY	GT17H-4P-2H	GT17H-4P-2DS	GT17H-4P-2DSA
Brown	GT17H-4S-ASSY(Key TypeA)	GT17H-4P-2H(A)	GT17H-4P-2DS(A)	GT17H-4P-2DSA(A)
Green	GT17H-4S-ASSY(Key TypeB)	GT17H-4P-2H(B)	GT17H-4P-2DS(B)	GT17H-4P-2DSA(B)
Blue	GT17H-4S-ASSY(Key TypeC)	GT17H-4P-2H(C)	GT17H-4P-2DS(C)	GT17H-4P-2DSA(C)

◆ Wiring Method (4-Conductor Straight 1 RowType)

- ① Insert housing to the cable.

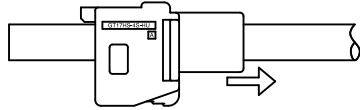

- ② Strip Jacket.

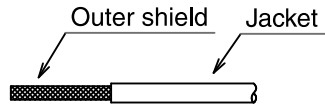

- ③ Turn Outer shield to backward.

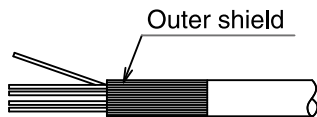

- ④ Cover the cable by conductive tape.

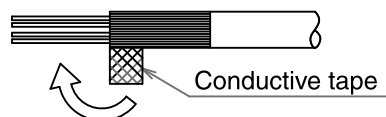

- ⑤ Cut extra outer shield.

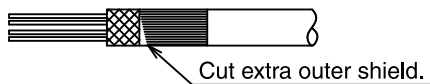

- ⑥ Strip Jacket.



- ⑦ Crimp the terminal.

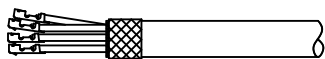

- ⑧ Insert terminal to the Insulator.



- ⑨ Set outer tube terminal to the insulator.

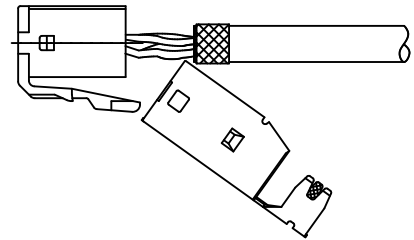

- ⑩ Set outer tube terminal to the insulator.

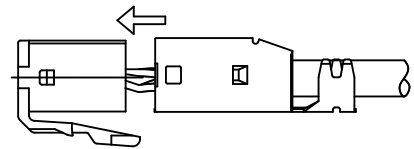

- ⑪ Crimp outertube terminal.

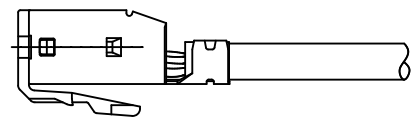

- ⑫ Slide up housing to outer tube terminal.

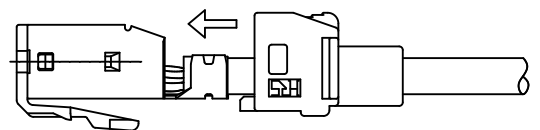

- ⑬ Finish.

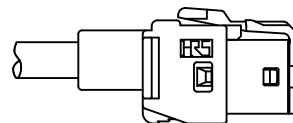

* Concerning the crimp height of terminals, crimp height settings have been prepared for each type of cable. Please contact a Hirose Electric account representative for further information.
Please note that new crimp height settings will be made for new cables and that this might take several days.
terminal insertion jig(GT17-45/PR-MD)

4-Conductor In-line Connectors (1 Row type)



◆The product comprises 6 parts.
(Housing, insulator, outer terminal, shield plate, retainer, and center terminal)

●Housing

Part Number	HRS No.	Material / Finish or Color	Packaging	RoHS
GT17HSP-4P-HU	767-0158-0	PBT / Light Gray	1piece	YES

●Insulator

Part Number	HRS No.	Material / Finish or Color	Packaging	RoHS
GT17HS-4P-2C	767-0155-2	PBT / Light Gray	1piece	YES

●Outer terminal

Part Number	HRS No.	Material / Finish or Color	Packaging	RoHS
GT17HS-4P-5CF	767-0156-5	Copper alloy /Tin plating	800pcs/reel	YES

●Shield

Part Number	HRS No.	Material / Finish or Color	Packaging	RoHS
GT17HS-4P-SC	767-0157-8	Copper alloy /Tin plating	1piece	YES

●Retainer

Part Number	HRS No.	Material / Finish or Color	Packaging	RoHS
GT17HS-4P-R	767-0159-3	PBT / Dark Gray	1piece	YES

●Center terminal

Part Number	HRS No.	Material / Finish or Color	Conductor Size(AWG)	Remarks	RoHS
GT8E-2428PCF	758-0067-6	Phosphor Bronze /Tin plating	#24 to #28	10,000 pcs/reel	YES

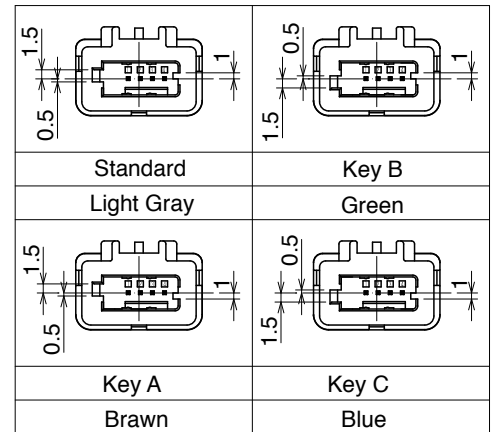

◆Mating Table

Color	GT17HS-4Pos In-line connector	Cable side F connector
Gray	GT17HSP-4P-ASSY	GT17H-4S-ASSY
Brown	GT17HSP-4P-ASSY(Key TypeA)	GT17H-4S-ASSY(Key TypeA)
Green	GT17HSP-4P-ASSY(Key TypeB)	GT17H-4S-ASSY(Key TypeB)
Blue	GT17HSP-4P-ASSY(Key TypeC)	GT17H-4S-ASSY(Key TypeC)

◆ Wiring Method (4-Conductor In-line 1 Row Type)

- ① Insert retainer to the cable.

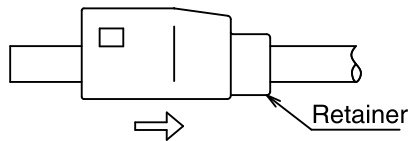

- ② Strip Jacket.

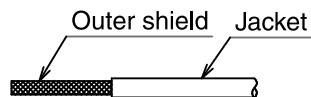

- ③ Turn Outer shield to backward.

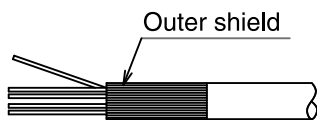

- ④ Cover the cable by conductive tape.

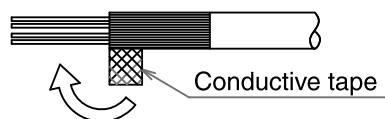

- ⑤ Cut extra outer shield.

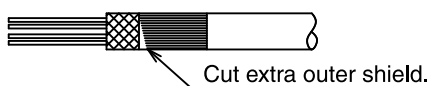

- ⑥ Strip Jacket.

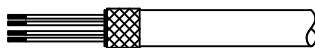

- ⑦ Crimp the terminal.

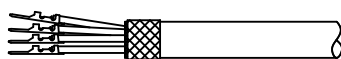

- ⑧ Insert terminal to the Insulator.

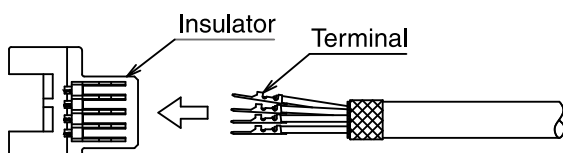

- ⑨ Set the insulator to the outer tube terminal.

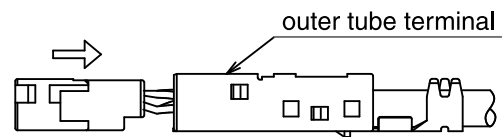

- ⑩ Crimp the outertube terminal.



- ⑪ Set the shield cover to the outer tube terminal.

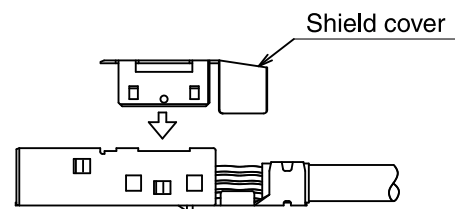

- ⑫ Insert the outer tube terminal to the housing.

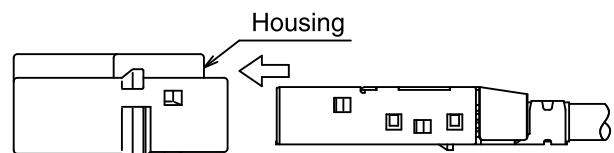

- ⑬ Slide up the retainer to the housing.

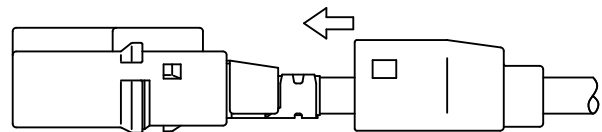

- ⑭ Finish

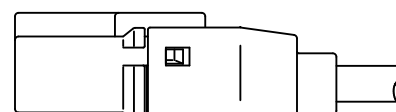

* Concerning the crimp height of terminals, crimp height settings have been prepared for each type of cable. Please contact a Hirose Electric account representative for further information.
Please note that new crimp height settings will be made for new cables and that this might take several days.

4-Conductor Right-angle Connectors (2x2 type)



Key variation



◆The product comprises 5 parts.
(Housing, insulator, outer terminal, retainer, center terminal)

●Housing

Part Number	HRS No.	Material / Finish or Color	Packaging	RoHS
GT17HN-4DS-HU	767-0141-8	PBT / Dark Gray	1piece	YES

●Insulator

Part Number	HRS No.	Material / Finish or Color	Packaging	RoHS
GT17HN-4DS-2C(A)	767-0140-5	PBT / Brown	1piece	YES
GT17HN-4DS-2C(B)	767-0147-4	PBT / Green	1piece	
GT17HN-4DS-2C(C)	767-0148-7	PBT /Blue	1piece	

●Outer terminal

Part Number	HRS No.	Material / Finish or Color	Packaging	RoHS
GT17HN-4DS-5CF	767-0142-0	Copper alloy /Tin plating	1piece	YES

●Retainer

Part Number	HRS No.	Material / Finish or Color	Packaging	RoHS
GT17HN-4DS-R	767-0143-3	PBT / Dark Gray	1piece	YES

●Center terminal

Part Number	HRS No.	Material / Finish or Color	Conductor Size(AWG)	Remarks	RoHS
GT8-2428SCF(70)	758-0001-8-70	Phosphor Bronze /Tin plating	#24 to #28	10,000 pcs/reel	YES

◆Mating Table

Color	Cable side connector	Board connector	
		Angle Type	Straight Type
Brown	GT17HN-4DS-ASSY(Key TypeA)	GT17HN-4DP-2H(A)	GT17HJ-4DP-2DSA
Green	GT17HN-4DS-ASSY(Key TypeB)	GT17HN-4DP-2H(B)	
		GT17HN-4/4DP-2H(BC)	
Blue	GT17HN-4DS-ASSY(Key TypeC)	GT17HN-4DP-2H(C)	
		GT17HN-4/4DP-2H(BC)	

◆ Wiring Method (4-Conductor Right-angle 2x2 Type)

① Strip Jacket.



② Turn Outer shield to backward.



③ Cover the cable by conductive tape.



④ Cut extra outer shield.



⑤ Strip Jacket.



⑥ Crimp the terminal.



⑦ Insert terminal to the Insulator.



⑧ Insert insulator to the Outer tube terminal.

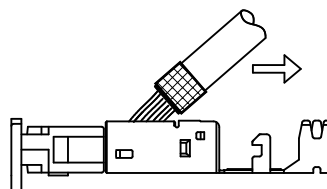

⑨ Bent the outer tube terminal 90.



⑩ Crimp the outer tube terminal.



⑪ Insert the assembled outer tube terminal to the housing.

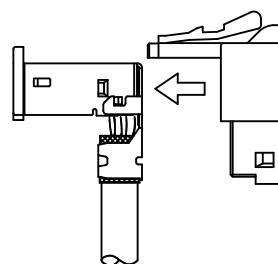

⑫ Set the Retainer.

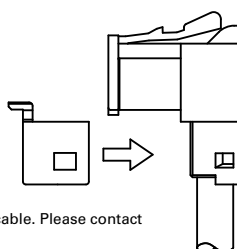

⑬ Finish.



* Concerning the crimp height of terminals, crimp height settings have been prepared for each type of cable. Please contact a Hirose Electric account representative for further information.
Please note that new crimp height settings will be made for new cables and that this might take several days.

4-Conductor Straight Connectors (2x2 type)



Key variation



◆The product comprises 4 parts.
(Housing, insulator, outer terminal, center terminal)

●Housing

Part Number	HRS No.	Material / Finish or Color	Packaging	RoHS
GT17HNS-4DS-HU	767-0150-9	PBT / Dark Gray	1piece	YES

●Insulator

Part Number	HRS No.	Material / Finish or Color	Packaging	RoHS
GT17HN-4DS-2C(A)	767-0140-5	PBT / Brown	1piece	YES
GT17HN-4DS-2C(B)	767-0147-4	PBT / Green	1piece	
GT17HN-4DS-2C(C)	767-0148-7	PBT /Blue	1piece	

●Outer terminal

Part Number	HRS No.	Material / Finish or Color	Packaging	RoHS
GT17HNS-4DS-5CF	767-0151-1	Copper alloy /Tin plating	1piece	YES

●Center terminal

Part Number	HRS No.	Material / Finish or Color	Conductor Size(AWG)	Remarks	RoHS
GT8-2428SCF(70)	758-0001-8-70	Phosphor Bronze /Tin plating	#24 to #28	10,000 pcs/reel	YES

◆Mating Table

Color	Cable side connector	Board connector	
		Angle Type	Straight Type
Brown	GT17HNS-4DS-ASSY(Key TypeA)	GT17HN-4DP-2H(A)	GT17HJ-4DP-2DSA
Green	GT17HNS-4DS-ASSY(Key TypeB)	GT17HN-4DP-2H(B)	
		GT17HN-4/4DP-2H(BC)	
Blue	GT17HNS-4DS-ASSY(Key TypeC)	GT17HN-4DP-2H(C)	
		GT17HN-4/4DP-2H(BC)	

◆ Wiring Method (4-Conductor Straight 2x2 Type)

- ① Insert housing to the cable.



- ② Strip Jacket.



- ③ Turn Outer shield to backward.



- ④ Cover the cable by conductive tape.



- ⑤ Cut extra outer shield.



- ⑥ Strip Jacket.



- ⑦ Crimp the terminal.



- ⑧ Insert terminal to the Insulator.



- ⑨ Set outer tube terminal to the insulator.



- ⑩ Set outer tube terminal to the insulator.



- ⑪ Crimp outertube terminal.



- ⑫ Slide up housing to outer tube terminal.



- ⑬ Finish.



* Concerning the crimp height of terminals, crimp height settings have been prepared for each type of cable. Please contact a Hirose Electric account representative for further information.
Please note that new crimp height settings will be made for new cables and that this might take several days.

16-Conductor Straight Connectors



◆The product comprises 4 parts.
(Housing, insulator, outer terminal, and center terminal)

●Housing

Part Number	HRS No.	Material / Finish or Color	Packaging	RoHS
GT17HNS-16DS-HU	767-0164-3	PBT / Dark Gray	1piece	YES

●Insulator

Part Number	HRS No.	Material / Finish or Color	Packaging	RoHS
GT17HN-16DS-2C	767-0162-8	PBT / Light Gray	1piece	YES

●Outer terminal

Part Number	HRS No.	Material / Finish or Color	Packaging	RoHS
GT17HNS-16DS-8CF	767-0165-6	Copper alloy / Tin plating	1piece	YES

●Center terminal

Part Number	HRS No.	Material / Finish or Color	Conductor Size(AWG)	Remarks	RoHS
GT8-2428SCF(70)	758-0001-8-70	Phosphor Bronze / Tin plating	#24 to #28	10,000 pcs/reel	YES

◆Mating Table

Board connector
GT17HN-16DP-2H

4-Conductor Board Connectors (1 Row type, Right-angle SMT Type, Right side key)



GT17H-4P-2H

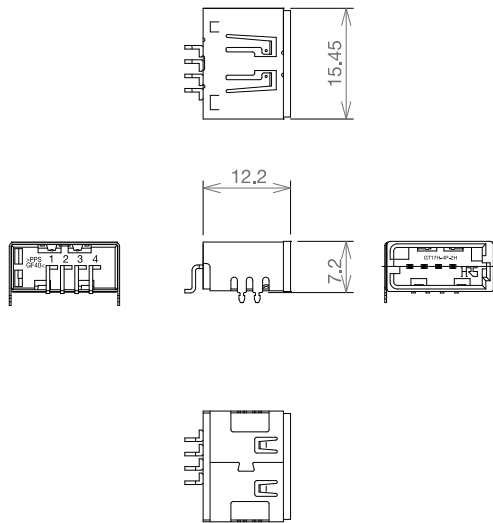

Standard Light Gray	Key B Green
Key A Brown	Key C Blue

Part Number	HRS No.	Color	Material / Finish	Packaging	RoHS
GT17H-4P-2H	767-0083-3	Light Gray	Housing:PPS Center terminal:Brass/Tin plating Outer terminal:Copper alloy/Tin plating	400 pcs/reel	YES
GT17H-4S-2C(A)	767-0167-1	Brown			
GT17H-4S-2C(B)	767-0168-4	Green			
GT17H-4S-2C(C)	767-0169-7	Blue			

4-Conductor SMT Connector(1 Row type, Left side key)



GT17HR-4P-2H

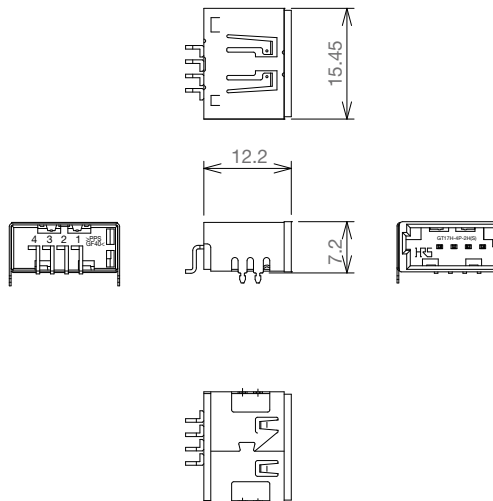

	Planning
Standard Light Gray	Key B Green
Planning	Planning
Key A Brown	Key C Blue

Part Number	HRS No.	Color	Material / Finish	Packaging	RoHS
GT17HR-4P-2H	767-0146-1	Light Gray	Housing:PPS Center terminal:Brass/Tin plating Outer terminal:Copper alloy/Tin plating	400 pcs/reel	YES

Coaxial cable connection of Antennas, Sensors, and Communication Trunk Lines

- GT 5
- GT 13
- GT 16
- PO5G
- GT 11
- GT 17
- GT 19
- GT 26
- GT 27
- GT 3
- GT 6W
- GT 7
- GT 10
- GT 18W
- GT 15
- GT 8
- GT 9
- GT 25
- GT 22

4-Conductor Printed Circuit Board Connector (1 Row, Right angle Right side key)



GT17H-4P-2DS



Part Number	HRS No.	Color	Material / Finish	Packaging	RoHS
GT17H-4P-2DS	767-0166-9	Light Gray	Housing:PPS Center terminal:Brass/Tin plating Outer terminal:Copper alloy/Tin plating	300 pcs/reel	YES
GT17H-4S-2DS(A)	767-0210-9	Brown			
GT17H-4S-2DS(B)	767-0211-1	Green			
GT17H-4S-2DS(C)	767-0212-1	Blue			

4-Conductor Printed Circuit Board Connector (1 Row type, Straight)



GT17H-4P-2DSA



Part Number	HRS No.	Color	Material / Finish	Packaging	RoHS
GT17H-4P-2DSA	767-0181-2	Light Gray	Housing:PPS Center terminal:Brass/Tin plating Outer terminal:Copper alloy/Tin plating	1piece	YES
GT17H-4P-2DSA(A)	767-0182-5	Brown			
GT17H-4P-2DSA(B)	767-0183-8	Green			
GT17H-4P-2DSA(C)	767-0184-0	Blue			

4-Conductor SMT Connector (2x2 type)

● With M2.6 screw flange



GT17HN-4DP-2H(A)



Part Number	HRS No.	Color	Material / Finish	Packaging	RoHS
GT17HN-4DP-2H(A)	767-0144-6	Brown	Housing:PPS	1piece	YES
GT17HN-4DP-2H(B)	767-0175-0	Green	Center terminal:Brass/Tin plating		
GT17HN-4DP-2H(C)	767-0176-2	Blue	Outer terminal:Copper alloy/Tin plating		

● With 3.2 dia. hole flange



GT17HN-4DP-2H(A)(11)



Part Number	HRS No.	Color	Material / Finish	Packaging	RoHS
GT17HN-4DP-2H(A)(11)	767-0144-6-11	Brown	Housing:PPS	1piece	YES
GT17HN-4DP-2H(B)(11)	767-0175-0-11	Green	Center terminal:Brass/Tin plating		
GT17HN-4DP-2H(C)(11)	767-0176-2-11	Blue	Outer terminal:Copper alloy/Tin plating		

● Without flange



GT17HN-4DP-2H(A)(14)

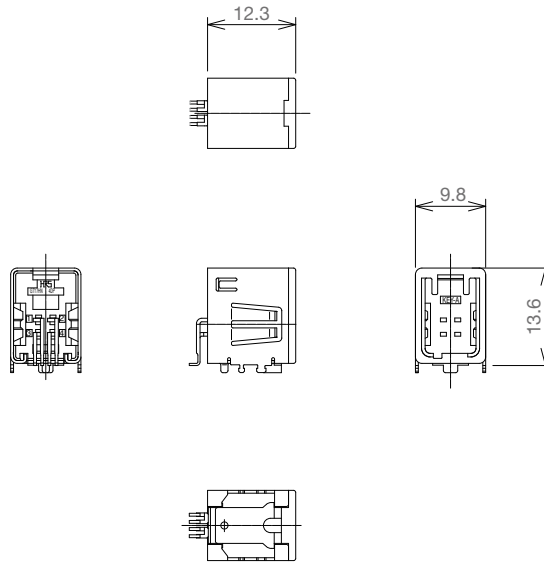

Part Number	HRS No.	Color	Material / Finish	Packaging	RoHS
GT17HN-4DP-2H(A)(14)	767-0144-6-14	Brown	Housing:PPS	300 pcs/reel	YES
GT17HN-4DP-2H(B)(14)	767-0175-0-14	Green	Center terminal:Brass/Tin plating		
GT17HN-4DP-2H(C)(14)	767-0176-2-14	Blue	Outer terminal:Copper alloy/Tin plating		

■ 4-Conductor Board Connector(2x2 type, Straight)



GT17HJ-4DP-2DSA



Part Number	HRS No.	Color	Material / Finish	Packaging	RoHS
GT17HJ-4DP-2DSA	767-0160-2	Brown	Housing:PPS Center terminal:Brass/Tin plating Outer terminal:Copper alloy/Tin plating	1piece	YES

4-Conductor Bordside Right angle DIP Type

● With M2.6 flange



GT17HN-4DP-2DS(A)

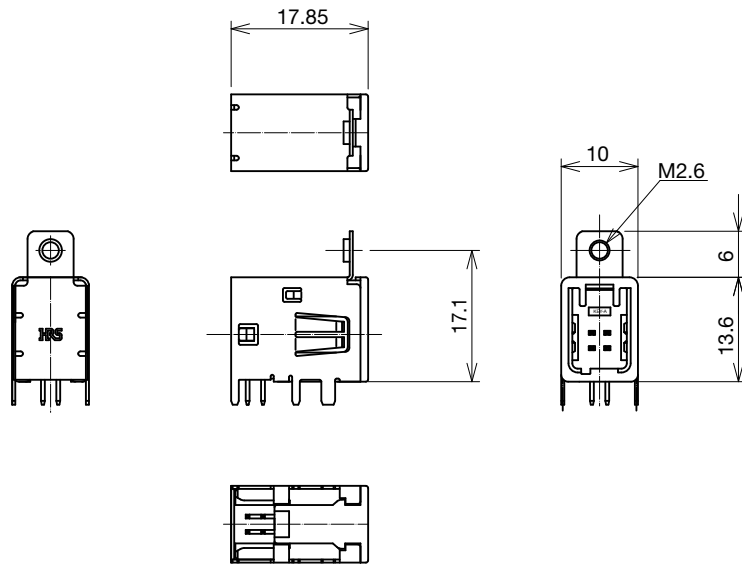

Part Number	HRS No.	Color	Material / Finish	Packaging	RoHS
GT17HN-4DP-2DS(A)	767-0213-7	Brown	Housing:PBT Center terminal:Brass/Tin plating Ceald cace:Copper alloy/Tin plating	1piece	YES

Note:Connector hight is measured from the PCB surface.

● Without flange



GT17HN-4DP-2DS(A)(10)

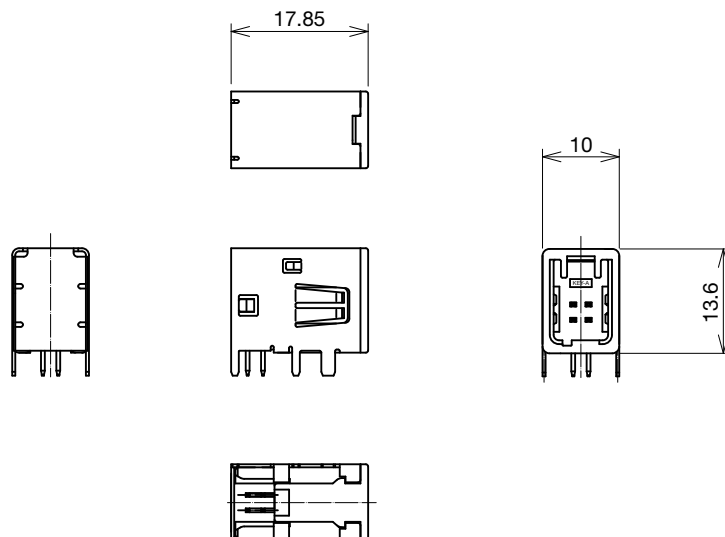

Part Number	HRS No.	Color	Material / Finish	Packaging	RoHS
GT17HN-4DP-2DS(A)(10)	767-0213-7-10	Brown	Housing:PBT Center terminal:Brass/Tin plating Ceald cace:Copper alloy/Tin plating	1piece	YES

Note:Connector hight is measured from the PCB surface.

● M2.5 Screw with Left flange

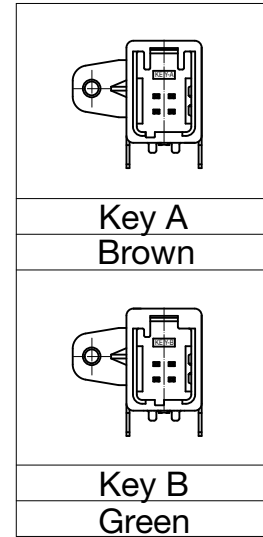

GT17HNL-4DP-2H(A)

Part Number	HRS No.	Color	Material / Finish	Packaging	RoHS
GT17HNL-4DP-2H(A)	767-0229-7	Brown	Housing:PBT Center terminal:Brass/Tin plating Ceald cace:Copper alloy/Tin plating	1piece	YES
GT17HNL-4DP-2H(B)	767-0237-5	Green			

Note:Connector hight is measured from the PCB surface.

● M2.6 Screw with Right flange



GT17HNR-4DP-2H(A)

Part Number	HRS No.	Color	Material / Finish	Packaging	RoHS
GT17HNR-4DP-2H(A)	767-0230-6	Brown	Housing:PBT Center terminal:Brass/Tin plating Ceald cace:Copper alloy/Tin plating	1piece	YES

Note:Connector hight is measured from the PCB surface.

4/4 Conductor SMT Connectors

● With M2.6 screw flange



GT17HN-4/4DP-2H(BC)

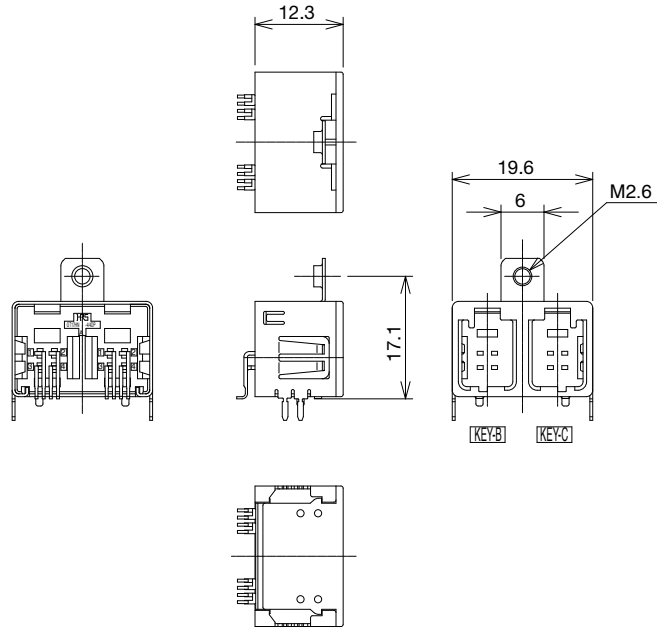

Part Number	HRS No.	Color	Material / Finish	Packaging	RoHS
GT17HN-4/4DP-2H(BC)	767-0145-9	Light Gray	Housing:PPS Center terminal:Brass/Tin plating Outer terminal:Copper alloy/Tin plating	1piece	YES

● Without flange



GT17HN-4/4DP-2H(BC)(14)



Part Number	HRS No.	Color	Material / Finish	Packaging	RoHS
GT17HN-4/4DP-2H(BC)(14)	767-0145-9-14	Light Gray	Housing:PPS Center terminal:Brass/Tin plating Outer terminal:Copper alloy/Tin plating	200 pcs/reel	YES

16 Conductor SMT Connectors

● With M2.6 screw flange



GT17HN-16DP-2H



Part Number	HRS No.	Color	Material / Finish	Packaging	RoHS
GT17HN-16DP-2H	767-0153-7	Light Gray	Housing:PPS Center terminal:Brass/Tin plating Outer terminal:Copper alloy/Tin plating	1piece	YES

● Without flange



GT17HN-16DP-2H(10)



Part Number	HRS No.	Color	Material / Finish	Packaging	RoHS
GT17HN-16DP-2H(10)	767-0153-7-10	Light Gray	Housing:PPS Center terminal:Brass/Tin plating Outer terminal:Copper alloy/Tin plating	200 pcs/reel	YES

26-Conductor Straight Connectors



◆The product comprises 6 parts.

(Housing, insulator, outer terminal, shield plate, retainer, and center terminal)

●Housing

Part Number	HRS No.	Material / Finish or Color	Packaging	Remarks	RoHS
GT17H-26DS-HU	767-0094-0	PBT / Light Gray	1piece	—	YES

●Insulator

Part Number	HRS No.	Material / Finish or Color	Packaging	Remarks	RoHS
GT17H-26DS-2C	767-0095-2	PBT / Dark Gray	1piece	—	YES

●Outer terminal

Part Number	HRS No.	Material / Finish or Color	Packaging	Remarks	RoHS
GT17H-26DS-6.5CF	767-0097-8	Copper alloy / Tin plating	612 pcs/pack	Lead free	YES

●Shield plate

Part Number	HRS No.	Material / Finish or Color	Packaging	Remarks	RoHS
GT17H-26DS-SC	767-0096-5	Copper alloy / Tin plating	612 pcs/pack	Lead free	YES

●Retainer

Part Number	HRS No.	Material / Finish or Color	Packaging	Remarks	RoHS
GT17H-26DS-R	767-0098-0	PBT / Dark Gray	1piece	—	YES

●Center terminal

Part Number	HRS No.	Material / Finish or Color	Conductor Size	Sheath Diameter	Notes	RoHS
GT25-2424SCF	775-0002-6	Copper alloy / Tin plating	AWG#20~24	ϕ 1.0~1.4	10,000 pcs/reel	YES
GT25-2428SCF	775-0013-2	Copper alloy / Tin plating	AWG#24~28	ϕ 1.3~1.5	10,000 pcs/reel	
GT25-2630SCF	775-0012-0	Copper alloy / Tin plating	AWG#26~30	ϕ 0.7~1.0	10,000 pcs/reel	

◆Mating Table

Color	Cable side connector	Board connector
Gray	GT17H-26DS-HU	GT17H-26DP-DS(Board type)
		GT17H-26DP-HU(In-line type)

26-Conductor Right-angle Connectors (Left Bend)



◆The product comprises 6 parts.
(Housing, insulator, outer terminal, shield plate, retainer, and center terminal)

●Housing

Part Number	HRS No.	Material / Finish or Color	Packaging	Remarks	RoHS
GT17HL-26DS-HU	767-0099-3	PBT / Light Gray	1piece	—	YES

●Insulator

Part Number	HRS No.	Material / Finish or Color	Packaging	Remarks	RoHS
GT17H-26DS-2C	767-0095-2	PBT / Dark Gray	1piece	—	YES

●Outer terminal

Part Number	HRS No.	Material / Finish or Color	Packaging	Remarks	RoHS
GT17HL-26DS-6.5CF	767-0101-3	Copper alloy /Tin plating	612 pcs/pack	Lead free	YES

●Shield plate

Part Number	HRS No.	Material / Finish or Color	Packaging	Remarks	RoHS
GT17HL/R-26DS-SC	767-0100-0	Copper alloy /Tin plating	612 pcs/pack	Lead free	YES

●Retainer

Part Number	HRS No.	Material / Finish or Color	Packaging	Remarks	RoHS
GT17HL-26DS-R	767-0102-6	PBT / Dark Gray	1piece	—	YES

●Center terminal

Part Number	HRS No.	Material / Finish or Color	Line Size	Cover Size	Note	RoHS
GT25-2428SCF	758-0013-2	Copper alloy /Tin plating	AWG#24~28	φ 1.3~1.5	10,000pcs/pack	YES
GT25-2630SCF	758-0012-0	Copper alloy /Tin plating	AWG#26~30	φ 0.7~1.0	10,000pcs/pack	

◆Mating Table

Color	Cable side connector	Boad connector
Gray	GT17HL-26DS-HU	GT17H-26DP-DS(Boad type)
		GT17H-26DP-HU(In -line type)

26-Conductor Straight Connectors (Right Bend)

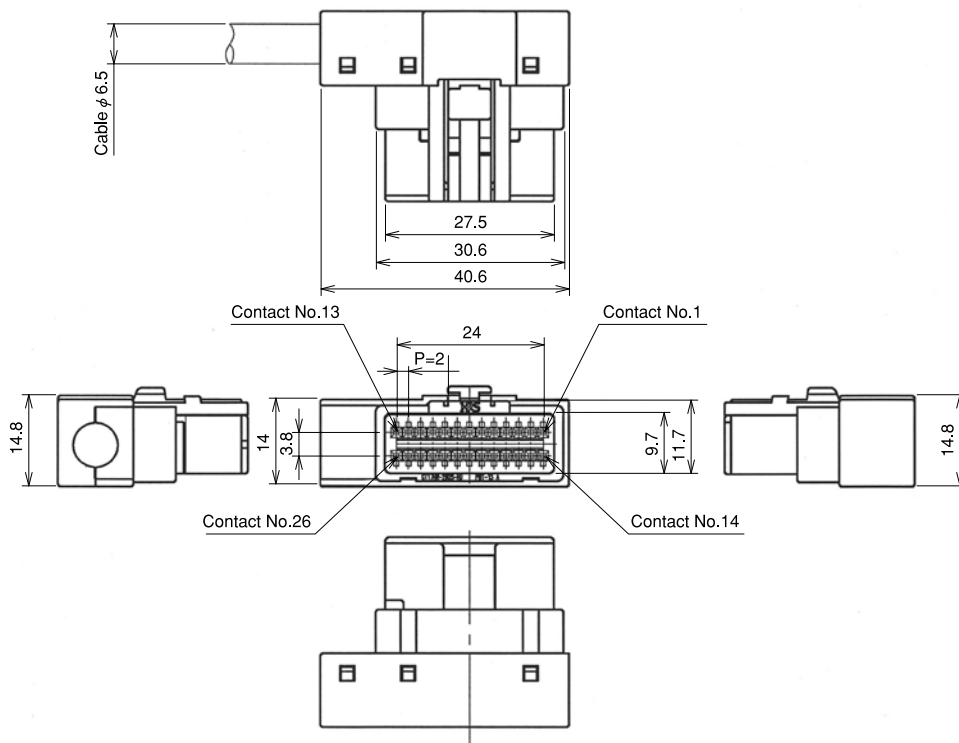

◆The product comprises 6 parts.

(Housing, insulaor, outer terminal, shield plate, retainer, and center terminal)

●Housing

Part Number	HRS No.	Material / Finish or Color	Packaging	Remarks	RoHS
GT17HR-26DS-HU	767-0118-6	PBT / Light Gray	1piece	—	YES

●Insulator

Part Number	HRS No.	Material / Finish or Color	Packaging	Remarks	RoHS
GT17H-26DS-2C	767-0095-2	PBT / Dark Gray	1piece	—	YES

●Outer terminal

Part Number	HRS No.	Material / Finish or Color	Packaging	Remarks	RoHS
GT17HR-26DS-6.5CF	767-0119-9	Copper alloy / Tin plating	612 pcs/pack	Lead free	YES

●Shield plate

Part Number	HRS No.	Material / Finish or Color	Packaging	Remarks	RoHS
GT17HL/R-26DS-SC	767-0100-0	Copper alloy / Tin plating	612 pcs/pack	Lead free	YES

●Retainer

Part Number	HRS No.	Material / Finish or Color	Packaging	Remarks	RoHS
GT17HR-26DS-R	767-0120-8	PBT / Dark Gray	1piece	—	YES

●Center terminal

Part Number	HRS No.	Material / Finish or Color	Line Size	Cover Size	Note	RoHS
GT25-2428SCF	758-0013-2	Copper alloy / Tin plating	AWG#24~28	φ 1.3~1.5	10,000pcs/reel	YES
GT25-2630SCF	758-0012-0	Copper alloy / Tin plating	AWG#26~30	φ 0.7~1.0	10,000pcs/reel	

◆Mating Table

Color	Cable side connector	Boad connector
Gray	GT17HR-26DS-HU	GT17H-26DP-DS(Boad type)
		GT17H-26DP-HU(In-line type)

26-Conductor Board Connectors (Color: Light Gray)

Part Number	HRS No.	Material / Finish or Color	Packaging	RoHS
GT17H-26DP-DS	767-0088-7	Housing: PBT/Light Gray Center terminal: Brass /Tin plating Shield Cover: Copper alloy /Tin plating	1piece	YES

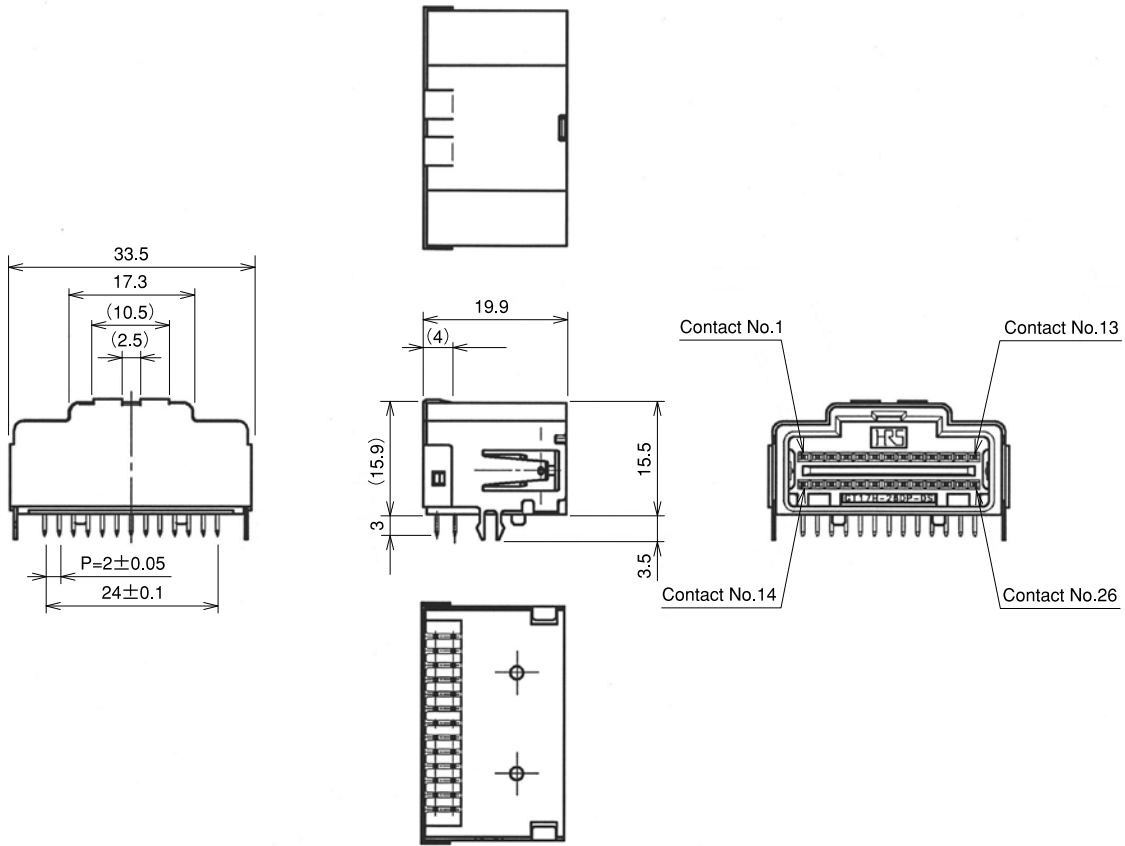

◆ Termination Tools

User's manuals are available. Please ask your Hirose Electric account representative.

● Automatic Crimping Machine (for 2-conductor and 8-conductor cable)



The photograph shows just one example. The product is subject to change.

Specifications

Item	Specification	Remarks
Capacity	1.5Ton	
Stroke	30mm	
Number of strokes	200spm (50Hz)	240spm (60Hz)
Weight	75kg	
Motor	0.2kW	AC100V
Crimping speed	2000 to 4000 pcs. per hour	

Part Number CM-105

Applicator

Product Number	HRS No.	Applicator Product Number	Applicator HRS No.
GT17-2022SCF	767-0009-0	AP105-GT17-2022S	901-5083-5
GT17-2428SCF	767-0010-0	AP105-GT17-2428S	901-5084-8
GT17-30SCF	767-0064-9	AP105-GT17-30S	901-5107-1
GT17-2022PCF	767-0082-0	AP105-GT17-2022P	901-5146-3
GT8-2428SCF(70)	758-0001-8-70	AP105-GT8-2428S	901-5174-9
GT8E-2428PCF	758-0067-6	AP105-GT8E-2428P	901-5192-0

Note1: Crimp heights may differ depending on the cable specification, so please consult a HRS representative for assistance.

Note2: Before purchasing Hirose tooling, please make sure that your selected cable will work with the Hirose applicator.

Note3: Cables that are different from those specified by Hirose may not be suitable and may require modification to the applicator to obtain a proper crimp.

Contact insert tool for GT17H-4S-2C

Product Number	HRS No.	Applicator Product Number	Applicator HRS No.
GT8-2428SCF(70)	758-0001-8-70	GT17-4S/PR-MD	902-5109-3

*This tool was designed when GT8-2428SCF(70) insert to GT17-4S-2C.

Please do not use other contact and housing.

GT 5

GT 13

GT 16

PO5G

GT 11

GT 17

GT 19

GT 26

GT 27

GT 3

GT 6W

GT 7

GT 10

GT 18W

GT 15

GT 8

GT 9

GT 25

GT 22

● HANDPRESS

Hand Press



Part Number HOS-7

Crimp tool for outer shield(Module for HOS-7)

Product Number	HRS No.	Crimp tool for outer shield Product Number	Crimp tool for outer shield HRS No.
GT17V-6DS-5CF	767-0027-2	GT17VS-6DS-5/CR-MP	902-5099-1
		GT17VS-6DS-5/CR-MP(01)	902-5099-1-01
		GT17VS-6DS-CH48/CR-MP	902-5105-2
		GT17VS-6DS-CH48/CR-MP(01)	902-5105-2-01
GT17VS-6DS-5CF	767-0050-4	GT17VS-6DS-5/CR-MP	902-5099-1
		GT17VS-6DS-5/CR-MP(01)	902-5099-1-01
GT17V-6DS-3.8CF	767-0075-5	GT17V-6DS-3.8/CR-MP	902-5101-1
		GT17V-6DS-3.8/CR-MP(01)	902-5101-1-01
GT17VS-6DP-5CF	767-0080-5	GT17VS-6DP-5/CR-MP	902-5088-5
		GT17VS-6DP-5/CR-MP(01)	902-5088-5-01
GT17S-8DS-7CF(70)	767-0106-7	GT17S-8DS-7/CR-MP	902-5090-7
		GT17S-8DS-7/CR-MP(01)	902-5090-7-01
GT17V-10DS-8CF	767-0037-6	GT17V-10DS/CR-MP	902-5057-1
		GT17V-10DS/CR-MP(01)	902-5057-1-01
GT17VS-10DS-8CF	767-0059-9	GT17V-10DS/CR-MP	902-5057-1
		GT17V-10DS/CR-MP(01)	902-5057-1-01
GT17VS-10DP-5.2CF	767-0114-5	GT17VS-10DP-5.2/CR-MP	902-5084-4
		GT17VS-10DP-5.2/CR-MP(01)	902-5084-4-01
GT17VS-10DS-4.6CF	767-0116-0	GT17VS-10DS-4.6/CR-MP	902-5083-1
		GT17VS-10DS-4.6/CR-MP(01)	902-5083-1-01
GT17H-4S-5CF	767-0087-4	GT17H-4S-5CF/CR-MP	902-5100-9
		GT17H-4S-5CF/CR-MP(01)	902-5100-9-01
GT17HS-4S-5CF	767-0135-5	GT17H-4S-5CF/CR-MP	902-5100-9
		GT17H-4S-5CF/CR-MP(01)	902-5100-9-01
GT17HS-4P-5CF	767-0156-5	GT17HS-4P-5CF/CR-MP	902-5108-0
		GT17HS-4P-5CF/CR-MP(01)	902-5108-0-01
GT17HN-4DS-5CF	767-0142-0	GT17HNS-4DS-5/CR-MP	902-5103-7
		GT17HNS-4DS-5/CR-MP(01)	902-5103-7-01
GT17HNS-4DS-5CF	767-0151-1	GT17HNS-4DS-5/CR-MP	902-5103-7
		GT17HNS-4DS-5/CR-MP(01)	902-5103-7-01
GT17HNS-16DS-8CF	767-0165-6	GT17HNS-16DS-8/CR-MP	902-5102-4
		GT17HNS-16DS-8/CR-MP(01)	902-5102-4-01
GT17H-26DP-6.5CF	767-0092-4	GT17H-26DP-6.5/CR1-MP	902-5079-4
		GT17H-26DP-6.5/CR1-MP(01)	902-5079-4-01
		GT17H-26DP-6.5/CR2-MP	902-5080-3
		GT17H-26DP-6.5/CR2-MP(01)	902-5080-3-01
GT17H-26DS-6.5CF	767-0097-8	GT17H-26DS-6.5/CR1-MP	902-5081-6
		GT17H-26DS-6.5/CR1-MP(01)	902-5081-6-01
		GT17H-26DS-6.5/CR2-MP	902-5085-7
		GT17H-26DS-6.5/CR2-MP(01)	902-5085-7-01
GT17HL-26DS-6.5CF	767-0101-3	GT17HL-26DS-6.5/CR1-MP	902-5082-9
		GT17HL-26DS-6.5/CR1-MP(01)	902-5082-9-01
		GT17HL-26DS-6.5/CR2-MP	902-5086-0
		GT17HL-26DS-6.5/CR2-MP(01)	902-5086-0-01
GT17HR-26DS-6.5CF	767-0119-9	GT17HL-26DS-6.5/CR1-MP	902-5082-9
		GT17HL-26DS-6.5/CR1-MP(01)	902-5082-9-01
		GT17HL-26DS-6.5/CR2-MP	902-5086-0
		GT17HL-26DS-6.5/CR2-MP(01)	902-5086-0-01

Note1: (01)is set unit (HOS-7 and Crimp tool).

Note2: Crimp height sets for each cable. Please ask HRS sales in detail. Take time to define new crimp height.

Note3: Please ask Crimp height for your cable when you use HRS tool.

Note4: Applicable tool may be changed by specic cable.

Компания «Океан Электроники» предлагает заключение долгосрочных отношений при поставках импортных электронных компонентов на взаимовыгодных условиях!

Наши преимущества:

- Поставка оригинальных импортных электронных компонентов напрямую с производств Америки, Европы и Азии, а так же с крупнейших складов мира;
- Широкая линейка поставок активных и пассивных импортных электронных компонентов (более 30 млн. наименований);
- Поставка сложных, дефицитных, либо снятых с производства позиций;
- Оперативные сроки поставки под заказ (от 5 рабочих дней);
- Экспресс доставка в любую точку России;
- Помощь Конструкторского Отдела и консультации квалифицированных инженеров;
- Техническая поддержка проекта, помощь в подборе аналогов, поставка прототипов;
- Поставка электронных компонентов под контролем ВП;
- Система менеджмента качества сертифицирована по Международному стандарту ISO 9001;
- При необходимости вся продукция военного и аэрокосмического назначения проходит испытания и сертификацию в лаборатории (по согласованию с заказчиком);
- Поставка специализированных компонентов военного и аэрокосмического уровня качества (Xilinx, Altera, Analog Devices, Intersil, Interpoint, Microsemi, Actel, Aeroflex, Peregrine, VPT, Syfer, Eurofarad, Texas Instruments, MS Kennedy, Miteq, Cobham, E2V, MA-COM, Hittite, Mini-Circuits, General Dynamics и др.);

Компания «Океан Электроники» является официальным дистрибьютором и эксклюзивным представителем в России одного из крупнейших производителей разъемов военного и аэрокосмического назначения «JONHON», а так же официальным дистрибьютором и эксклюзивным представителем в России производителя высокотехнологичных и надежных решений для передачи СВЧ сигналов «FORSTAR».



JONHON

«JONHON» (основан в 1970 г.)

Разъемы специального, военного и аэрокосмического назначения:

(Применяются в военной, авиационной, аэрокосмической, морской, железнодорожной, горно- и нефтедобывающей отраслях промышленности)

«FORSTAR» (основан в 1998 г.)

ВЧ соединители, коаксиальные кабели, кабельные сборки и микроволновые компоненты:

(Применяются в телекоммуникациях гражданского и специального назначения, в средствах связи, РЛС, а так же военной, авиационной и аэрокосмической отраслях промышленности).



Телефон: 8 (812) 309-75-97 (многоканальный)

Факс: 8 (812) 320-03-32

Электронная почта: ocean@oceanchips.ru

Web: <http://oceanchips.ru/>

Адрес: 198099, г. Санкт-Петербург, ул. Калинина, д. 2, корп. 4, лит. А