

## 1 Features

- GPS antenna designed for embedded applications
- Designed for use with the ground plane extended beneath the antenna
- Good efficiency to size ratio
- Near omni-directional characteristics enable good performance for any device orientation
- Good resistance to de-tuning
- Intended for SMD mounting
- Supplied in tape on reel
- Low profile, small footprint, light weight

## 2 Description

The A10204 GPS antenna is intended for reception of GPS signals at 1575 MHz.

The antenna uses a ground plane in order to radiate efficiently. It should be noted that the radiation patterns and efficiency will change with the size of the ground plan, and optimized efficiency is achieved with appropriate matching.

The antenna has RHCP characteristics suitable for reception of GPS signals.

## 3 Applications

- Small mobile and handheld devices with embedded GPS systems
- Application specific tracking modules
- GPS accessories: USB dongle, SDIO cards, PCMCIA card

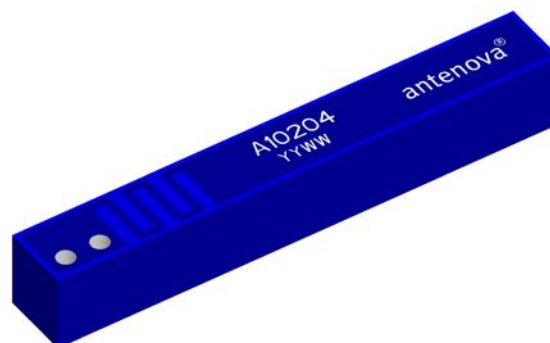

## 4 Part number

**Brevis: A10204**



## 5 General data

Product name	Brevis GPS
Part Number	A10204
Frequency	GPS - 1575 MHz
Polarization	Linear
Operating temperature	-40 °C to +85 °C
Impedance with matching	50 Ω
Weight	<0.2 g
Antenna type	SMD
Dimensions	3 x 22 x 3 [mm]

## 6 Electrical characteristics

	Typical performance	Conditions
Bandwidth	>50 MHz at -10 dB Return Loss	All data measured on Antenova's reference boards, part numbers A10204-U1
Peak gain (Linear)	0 dBi	
Average gain (Linear)	-2.4 dBi	
Average efficiency (Linear)	>50%	
Peak gain (RHCP)	-2.8 dBi	
Average gain (RHCP)	-5 dBi	
Average efficiency (RHCP)	>30%	
Maximum Return Loss	-17 dB	
Maximum VSWR	1.4:1	

## 7 Electrical performance

### 7-1 Return Loss

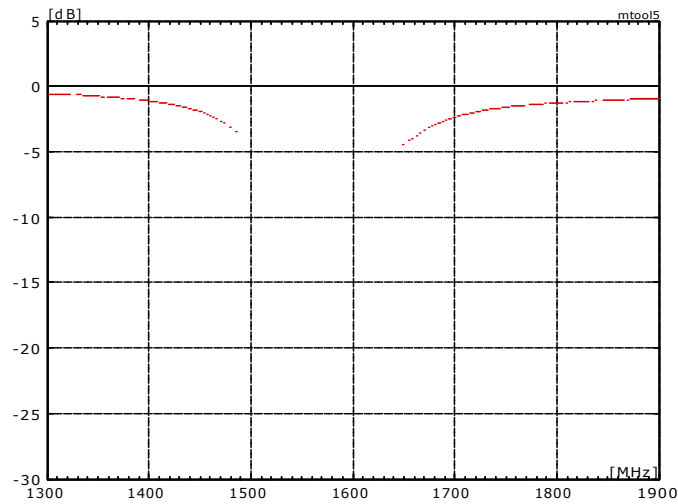

Reference Board A10204-U1

### 7-2 VSWR

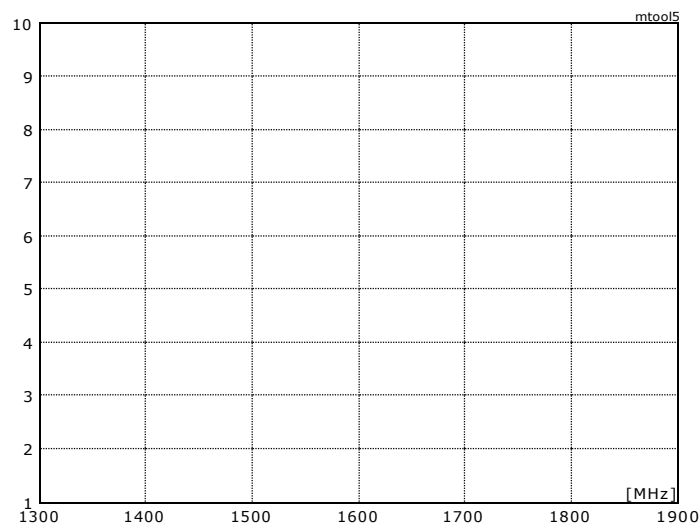

Reference Board A10204-U1

## 7-3 Antenna patterns

### 7.3.1. Reference Board A10204-U1 [Linear Polarization]

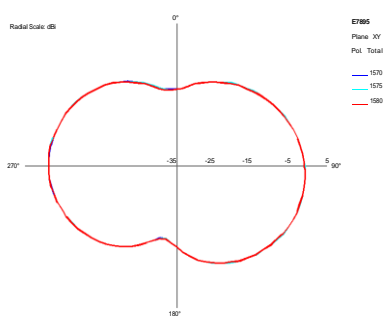
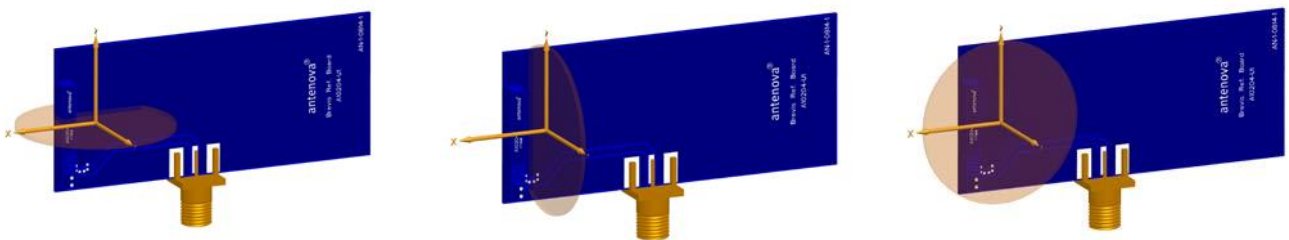
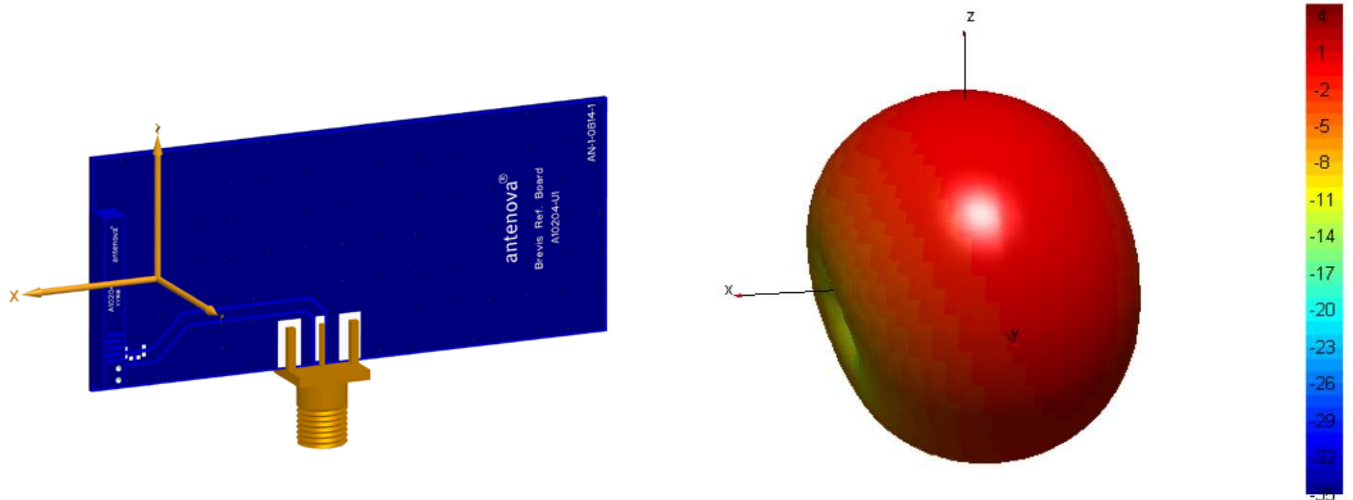

XY plane

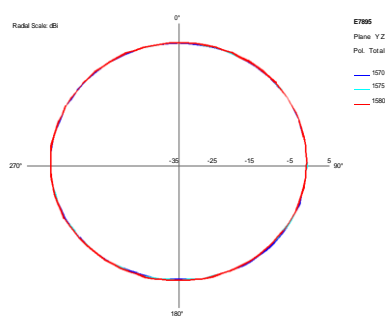

YZ plane

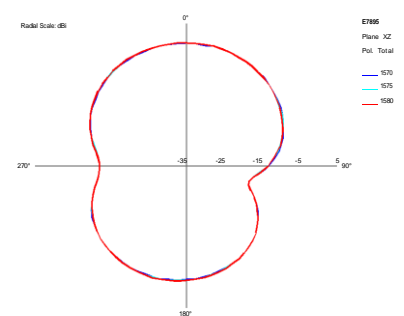

XZ plane

Patterns show combined polarisations  
measured on reference board A10204-U1

### 7.3.2. Active Test Patterns

The typical radiation pattern of the Brevis A10204 GPS antenna has been measured in Antenova's "Active GPS" chamber, using Antenova's standard RF module based on SiRFstarIII™ GSC3LT IC combined with two stages of Saw Filters.

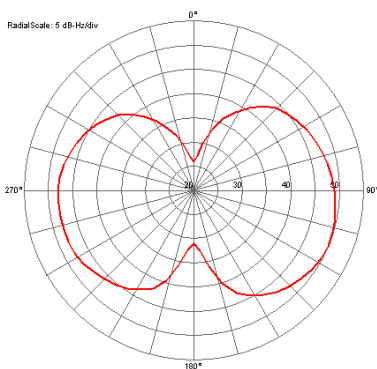
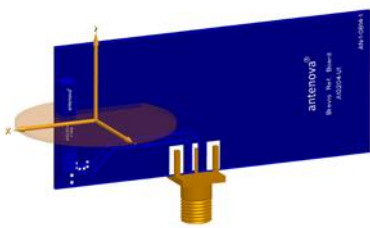
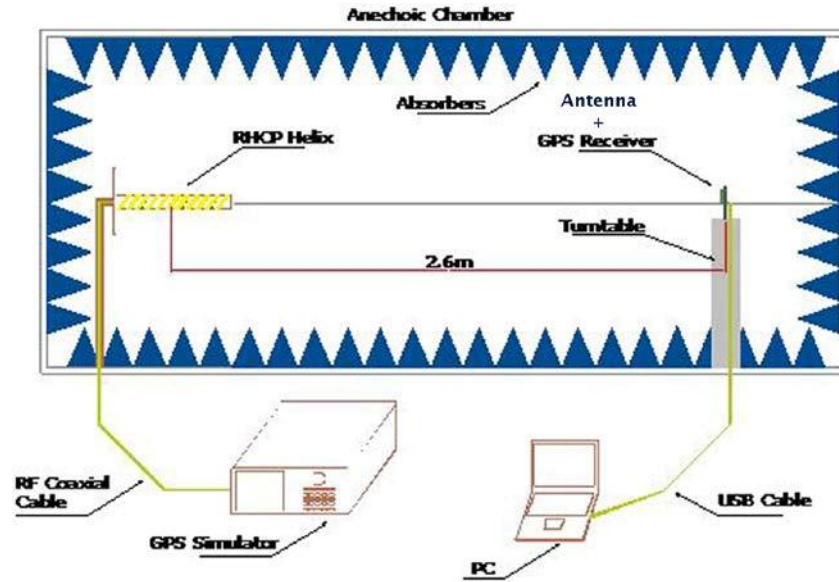

XY plane

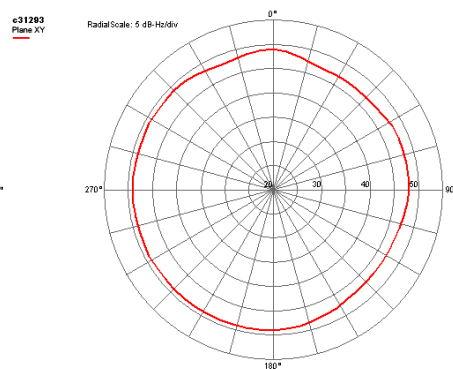
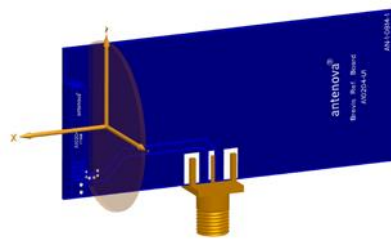

YZ plane

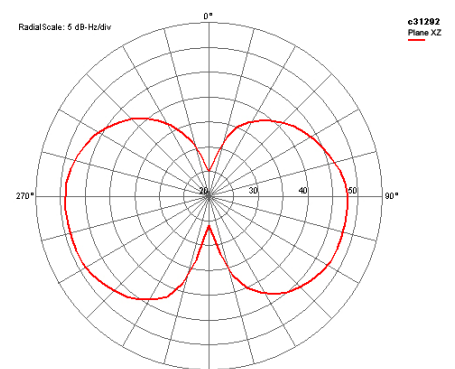
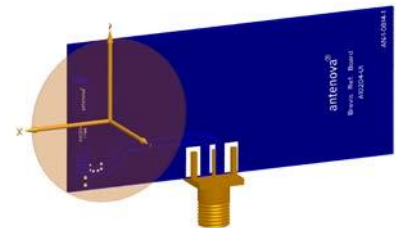

XZ plane

The above plots are CN number in dB.Hz on a scale of 20-50 dB.Hz.

## 8 Antenna dimensions

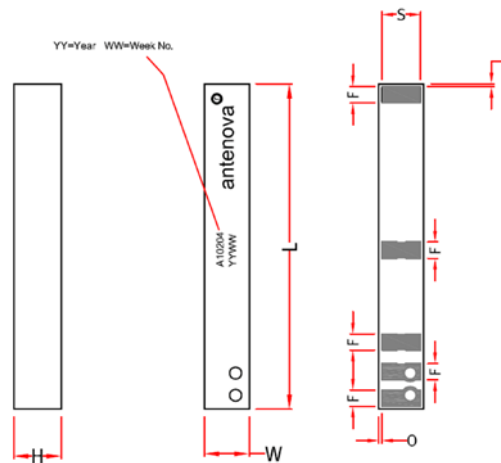

L	W	H	F	S	O	L
Length	Width	Height				
22.0 +/- 0.2	3.0 +/- 0.2	3.2 +/- 0.15	1.1 +/- 0.15	2.6 +/- 0.15	0.2 +/- 0.15	0.35 +/- 0.15

Dimensions in mm

## 9 Antenna footprint

Brevis (Part No: A10204)

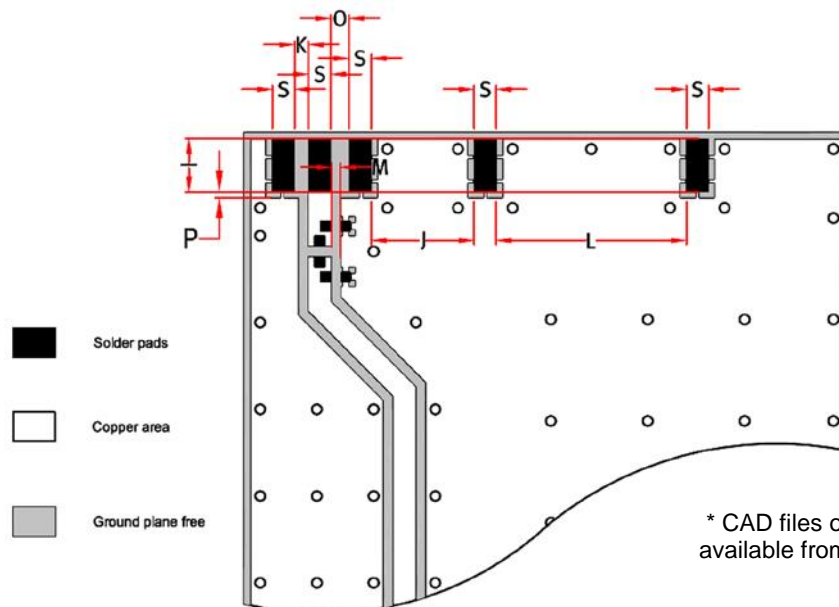

\* CAD files of the antenna footprint are available from [www.antenna-m2m.com](http://www.antenna-m2m.com)

I	S	K	J	L	O	M	P
2.6 +/- 0.1	1.1 +/- 0.1	0.7 +/- 0.1	5.1 +/- 0.1	9.4 +/- 0.1	0.9 +/- 0.1	0.43 +/- 0.1	0.30 +/- 0.1

Dimensions in mm

## 10 Electrical interface

### 10-1 Transmission lines

- All transmission lines should be designed to have a characteristic impedance of 50  $\Omega$
- The length of the transmission lines should be kept to a minimum
- Any other parts of the RF system like transceivers, power amplifiers, etc, should also be designed to have an impedance of 50  $\Omega$

Once the material for the PCB has been chosen (PCB thickness and dielectric constant), a coplanar transmission line can easily be designed using any of the commercial software packages for transmission line design. For the chosen PCB thickness, copper thickness and substrate dielectric constant, the program will calculate the appropriate transmission line width and gaps on either side of the track so the characteristic impedance of the coplanar transmission line is 50 $\Omega$ .

### 10-2 Matching circuit

The antenna requires a matching circuit that must be optimized for each customer's product. The matching circuit will require up to three components and the following pad layout should be designed into the device so the correct circuit can be installed:

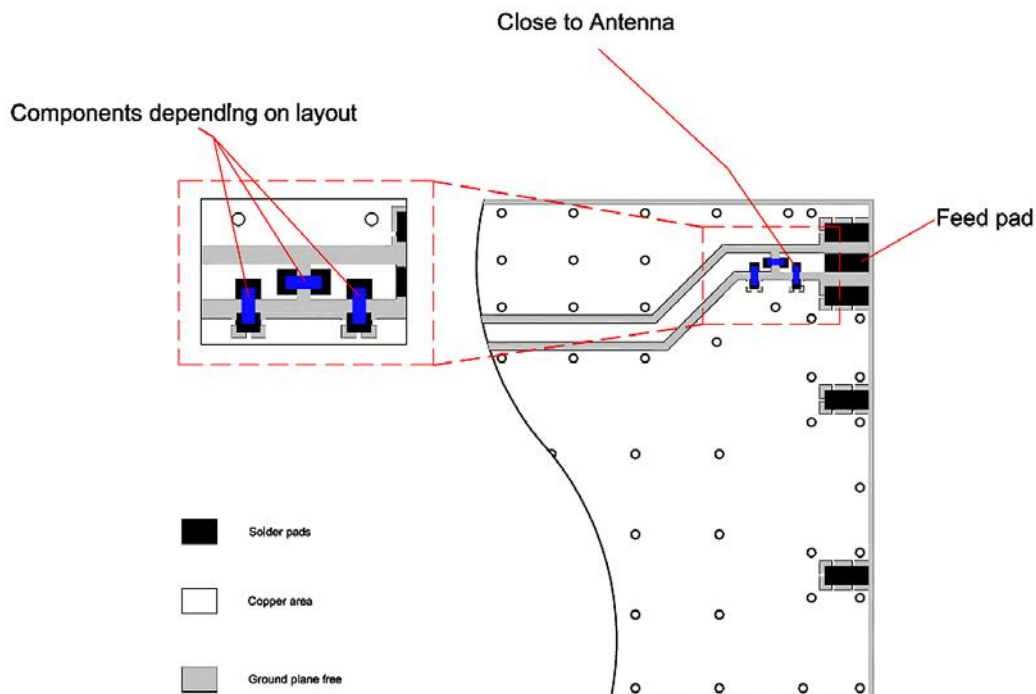

The antenna feed pad and the antenna ground pads are indicated in the drawing above. Additional pads are for mechanical attachment only and should not be grounded.

In addition to the matching circuit, a separate DC blocking capacitor will also be required between the radio and the antenna matching circuit.

**Note: The component values for the matching circuit will vary depending on the size of the PCB and surrounding components.** The impedance of the antenna should be measured before selecting suitable matching components. Antenova M2M offers this service on request. Contact [sales@antenova-m2m.com](mailto:sales@antenova-m2m.com) for further information.

### 10-3 Antenna placement

Antenna placement locations and orientations are critical for achieving optimal system performance. Antenova strongly recommends placing the antenna near the edge of the board. Maximum antenna performance is achieved by placing the antenna towards one of the corners of the PCB, with the feed point of the antenna as close to the corner of the PCB as possible.

Antenova M2M offers a full range of development support to ensure efficient implementation of the antenna into the specific design. To overcome RF design issues, matching circuits, transmission lines, layout and other components, please contact Antenova M2M ([sales@antenova-m2m.com](mailto:sales@antenova-m2m.com)) for design and placement recommendations.

### 10-4 Reference board

The reference board has been designed for evaluation purposes of the Brevis A10204 antenna and it includes a SMA female connector

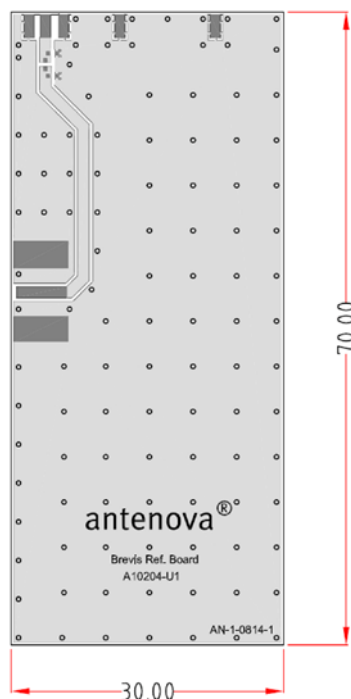

Dimensions in mm

Contact [sales@antenova-m2m.com](mailto:sales@antenova-m2m.com) for further details



## 11 Soldering

This antenna is suitable for lead free soldering.

The reflow profile should be adjusted to suit the PCBA, oven and solder paste, while observing the following conditions:

- The maximum temperature should not exceed 240 °C
- However for lead free soldering, a maximum temperature of 255 °C for no more than 20 seconds is permitted.
- The antenna should not be exposed to temperatures exceeding 120 °C more than 3 times during the soldering process.

## 12 Hazardous material regulation conformance

The antenna has been tested to conform to RoHS requirements. A certificate of conformance is available from Antenova M2M's website.

## 13 Packaging

### 13-1 Optimal storage conditions for packaged reels

<b>Temperature</b>	-10°C to 40°C
<b>Humidity</b>	Less than 75% RH
<b>Shelf Life</b>	18 Months
<b>Storage place</b>	Away from corrosive gas and direct sunlight
<b>Packaging</b>	Reels should be stored in unopened sealed manufacturer's plastic packaging.

**Note:** Storage of open reels of antennas is not recommended due to possible oxidization of pads on antennas. If short term storage is necessary, then it is highly recommended that the bag containing the antenna reel is re-sealed and stored in like storage conditions as in above table.

### 13-2 Tape characteristics

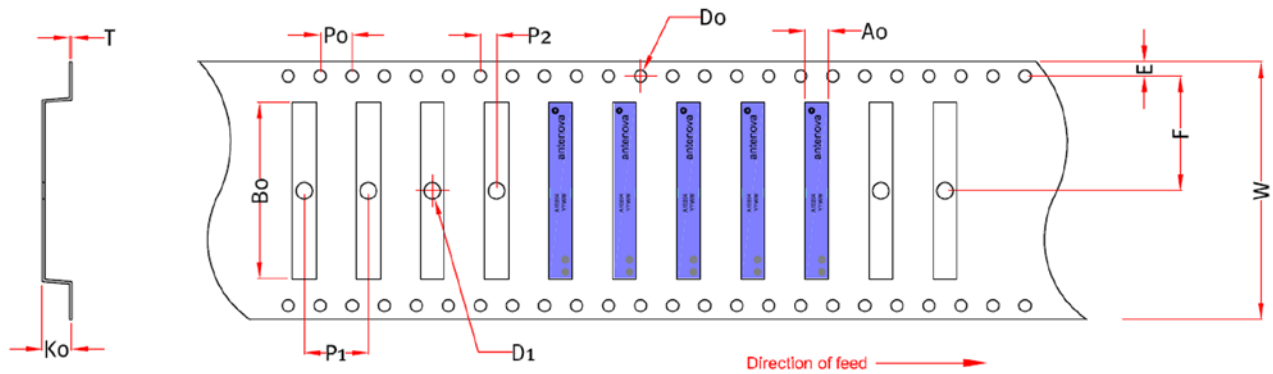

W	F	E	P0	P1	P2	B0	K0	T	D0	D1	A0
32.0 +/- 0.3	26.2 +/- 0.1	1.75 +/- 0.1	4.0 +/- 0.1	8.0 +/- 0.1	2.0 +/- 0.1	22.35 +/- 0.1	3.55 +/- 0.1	0.3 +/- 0.1	1.5 +/- 0.1	2.05 +/- 0.1	3.3 +/- 0.05

Dimensions in mm

Quantity	Leading Space	Trailing Space
2000 pcs / reel	50 blank antenna holders	37 blank antenna holders

### 13-3 Reel dimensions

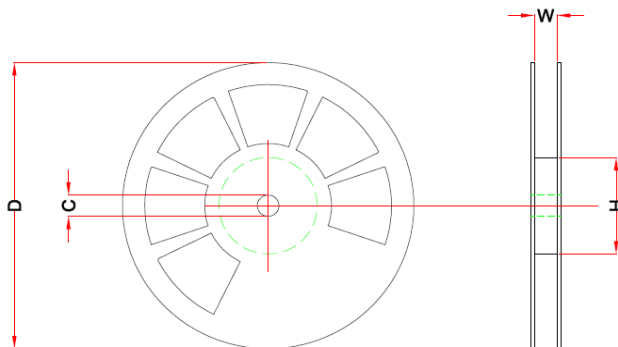

Width (W)	Reel Diameter (D)	Hub Diameter (H)	Shaft Diameter (C)
57.5	330 +/- 2.0	80	13 +/- 0.5

### 13-4 Box dimensions

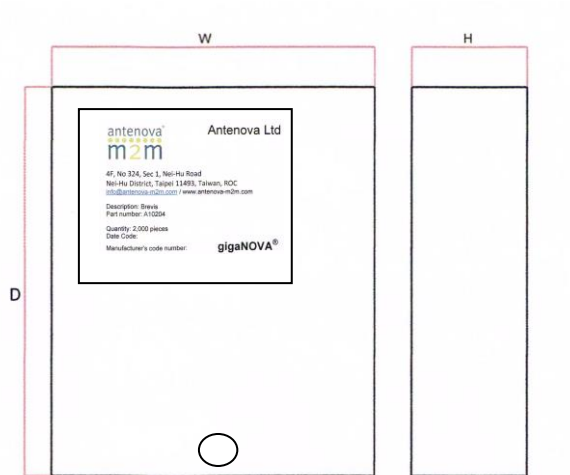

Width (W)	Breadth (B)	Thickness (H)
345 mm	354 mm	45 mm

### 13-5 Bag properties

Reels are supplied in protective plastic packaging

### 13-6 Reel label information

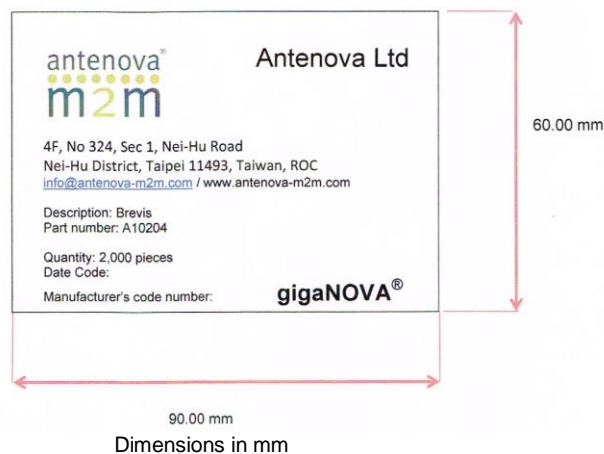



**[www.antenova-m2m.com](http://www.antenova-m2m.com)**

**Corporate Headquarters**

Antenova Ltd.  
2<sup>nd</sup> Floor, Titan Court  
3 Bishop Square  
Hatfield  
AL10 9NA

**North America Headquarters**

Antenova Ltd.  
100 Brush Creek Road, Suite 103  
Santa Rosa,  
California, 95404  
USA

**Asia Headquarters**

Antenova Asia Ltd.  
4F, No. 324, Sec. 1, Nei-Hu Road  
Nei-Hu District  
Taipei 11493  
Taiwan, ROC

**Tel:** +44 1223 810600  
**Email:** sales@antenova-m2m.com

**Tel:** +1 707 890 5202  
**Email:** sales@antenova-m2m.com

**Tel:** +886 (0) 2 8797 8630  
**Fax:** +886 (0) 2 8797 6890  
**Email:** sales@antenova-m2m.com

**Copyright® Antenova Ltd.** All Rights Reserved. Antenova®, Antenova M2M®, gigaNOVA®, the Antenova product family names, and the Antenova and Antenova M2M logos are trademarks and/or registered trademarks of Antenova Ltd. Any other names and/or trademarks belong to their respective companies.

The materials provided herein are believed to be reliable and correct at the time of print. Antenova does not warrant the accuracy or completeness of the information, text, graphics or other items contained within this information. Antenova further assumes no responsibility for the use of this information, and all such information shall be entirely at the user's risk.



Certificate No: 4598

**Antennas for Wireless M2M Applications**

Компания «Океан Электроники» предлагает заключение долгосрочных отношений при поставках импортных электронных компонентов на взаимовыгодных условиях!

Наши преимущества:

- Поставка оригинальных импортных электронных компонентов напрямую с производств Америки, Европы и Азии, а так же с крупнейших складов мира;
- Широкая линейка поставок активных и пассивных импортных электронных компонентов (более 30 млн. наименований);
- Поставка сложных, дефицитных, либо снятых с производства позиций;
- Оперативные сроки поставки под заказ (от 5 рабочих дней);
- Экспресс доставка в любую точку России;
- Помощь Конструкторского Отдела и консультации квалифицированных инженеров;
- Техническая поддержка проекта, помощь в подборе аналогов, поставка прототипов;
- Поставка электронных компонентов под контролем ВП;
- Система менеджмента качества сертифицирована по Международному стандарту ISO 9001;
- При необходимости вся продукция военного и аэрокосмического назначения проходит испытания и сертификацию в лаборатории (по согласованию с заказчиком);
- Поставка специализированных компонентов военного и аэрокосмического уровня качества (Xilinx, Altera, Analog Devices, Intersil, Interpoint, Microsemi, Actel, Aeroflex, Peregrine, VPT, Syfer, Eurofarad, Texas Instruments, MS Kennedy, Miteq, Cobham, E2V, MA-COM, Hittite, Mini-Circuits, General Dynamics и др.);

Компания «Океан Электроники» является официальным дистрибьютором и эксклюзивным представителем в России одного из крупнейших производителей разъемов военного и аэрокосмического назначения «JONHON», а так же официальным дистрибьютором и эксклюзивным представителем в России производителя высокотехнологичных и надежных решений для передачи СВЧ сигналов «FORSTAR».



## JONHON

«JONHON» (основан в 1970 г.)

Разъемы специального, военного и аэрокосмического назначения:

(Применяются в военной, авиационной, аэрокосмической, морской, железнодорожной, горно- и нефтедобывающей отраслях промышленности)

«FORSTAR» (основан в 1998 г.)

ВЧ соединители, коаксиальные кабели, кабельные сборки и микроволновые компоненты:

(Применяются в телекоммуникациях гражданского и специального назначения, в средствах связи, РЛС, а так же военной, авиационной и аэрокосмической отраслях промышленности).



Телефон: 8 (812) 309-75-97 (многоканальный)

Факс: 8 (812) 320-03-32

Электронная почта: [ocean@oceanchips.ru](mailto:ocean@oceanchips.ru)

Web: <http://oceanchips.ru/>

Адрес: 198099, г. Санкт-Петербург, ул. Калинина, д. 2, корп. 4, лит. А