

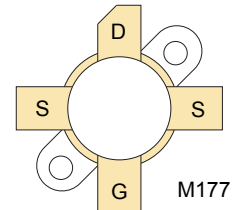

## RF POWER VERTICAL MOSFET

The VRF2944 is a gold-metallized silicon n-channel RF power transistor designed for broadband commercial and military applications requiring high power and gain without compromising reliability, ruggedness, or inter-modulation distortion.



### FEATURES

- Improved Ruggedness  $V_{(BR)DSS} = 170V$
- 400W with 22dB Typ. Gain @ 30MHz, 50V
- Excellent Stability & Low IMD
- Common Source Configuration
- Available in Matched Pairs
- 70:1 Load VSWR Capability at Specified Operating Conditions
- Nitride Passivated
- Refractory Gold Metallization
- Higher Power Version of VRF2933
- Thermally Enhanced Package
- RoHS Compliant 

### Maximum Ratings

All Ratings:  $T_c = 25^\circ C$  unless otherwise specified

Symbol	Parameter	VRF2933(MP)	Unit
$V_{DSS}$	Drain-Source Voltage	170	V
$I_D$	Continuous Drain Current @ $T_c = 25^\circ C$	50	A
$V_{GS}$	Gate-Source Voltage	$\pm 40$	V
$P_D$	Total Device dissipation @ $T_c = 25^\circ C$	795	W
$T_{STG}$	Storage Temperature Range	-65 to 150	$^\circ C$
$T_J$	Operating Junction Temperature Max	200	

### Static Electrical Characteristics

Symbol	Parameter	Min	Typ	Max	Unit
$V_{(BR)DSS}$	Drain-Source Breakdown Voltage ( $V_{GS} = 0V, I_D = 100mA$ )	170	180		V
$V_{DS(ON)}$	On State Drain Voltage ( $I_{D(ON)} = 25A, V_{GS} = 10V$ )		1.7	2.1	
$I_{DSS}$	Zero Gate Voltage Drain Current ( $V_{DS} = 100V, V_{GS} = 0V$ )			2.0	mA
$I_{GSS}$	Gate-Source Leakage Current ( $V_{DS} = \pm 20V, V_{GS} = 0V$ )			2.0	$\mu A$
$g_{fs}$	Forward Transconductance ( $V_{DS} = 10V, I_D = 20A$ )	10			mhos
$V_{GS(TH)}$	Gate Threshold Voltage ( $V_{DS} = 10V, I_D = 100mA$ )	2.9	3.6	4.4	V

### Thermal Characteristics

Symbol	Characteristic	Min	Typ	Max	Unit
$R_{\theta JC}$	Junction to Case Thermal Resistance			0.22	$^\circ C/W$

 **CAUTION:** These Devices are Sensitive to Electrostatic Discharge. Proper Handling Procedures Should Be Followed.

## Dynamic Characteristics

VRF2944(MP)

Symbol	Parameter	Test Conditions	Min	Typ	Max	Unit
$C_{iss}$	Input Capacitance	$V_{GS} = 0V$ $V_{DS} = 50V$ $f = 1MHz$		1050		pF
$C_{oss}$	Output Capacitance			520		
$C_{rss}$	Reverse Transfer Capacitance			62		

## Functional Characteristics

Symbol	Parameter	Min	Typ	Max	Unit
$G_{PS}$	$f_1 = 30MHz, V_{DD} = 50V, I_{DQ} = 250mA, P_{out} = 400W$	23	25		dB
$\eta_D$	$f_1 = 30MHz, V_{DD} = 50V, I_{DQ} = 250mA, P_{out} = 400W$		50		%
$\psi$	$f = 30MHz, V_{DD} = 50V, I_{DQ} = 250mA, P_{out} = 400W$ CW 70:1 VSWR - All Phase Angles, 0.2mSec X 20% Duty Factor	No Degradation in Output Power			

Microsemi reserves the right to change, without notice, the specifications and information contained herein.

## Typical Performance Curves

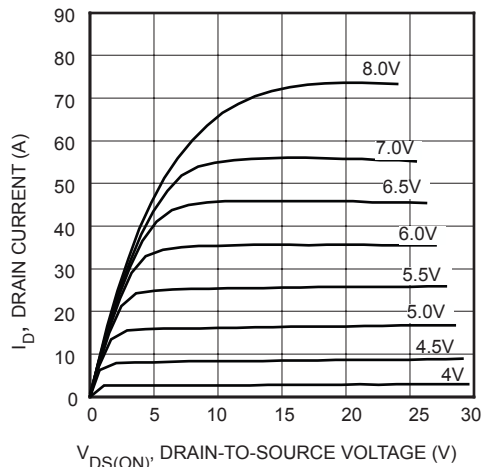

FIGURE 1, Output Characteristics

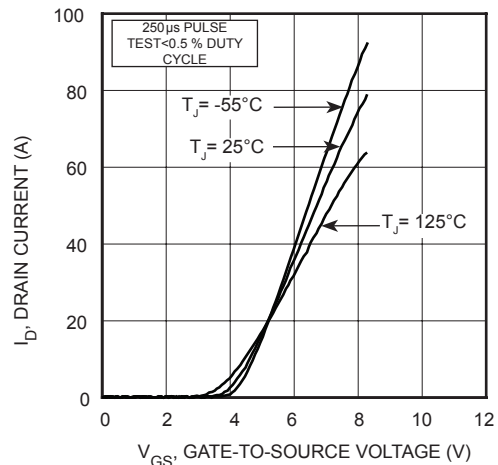

FIGURE 2, Transfer Characteristics

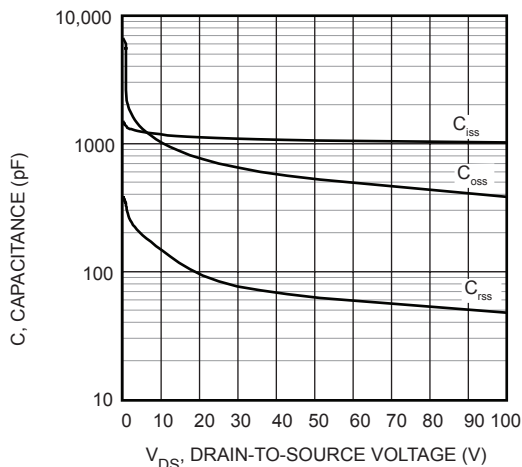

FIGURE 3, Capacitance vs Drain-to-Source Voltage

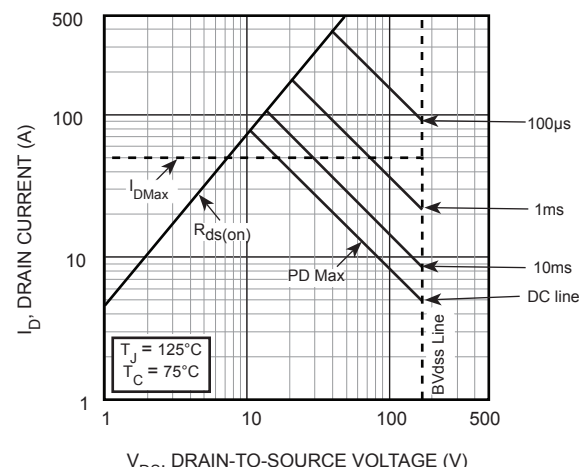

FIGURE 4, Forward Safe Operating Area

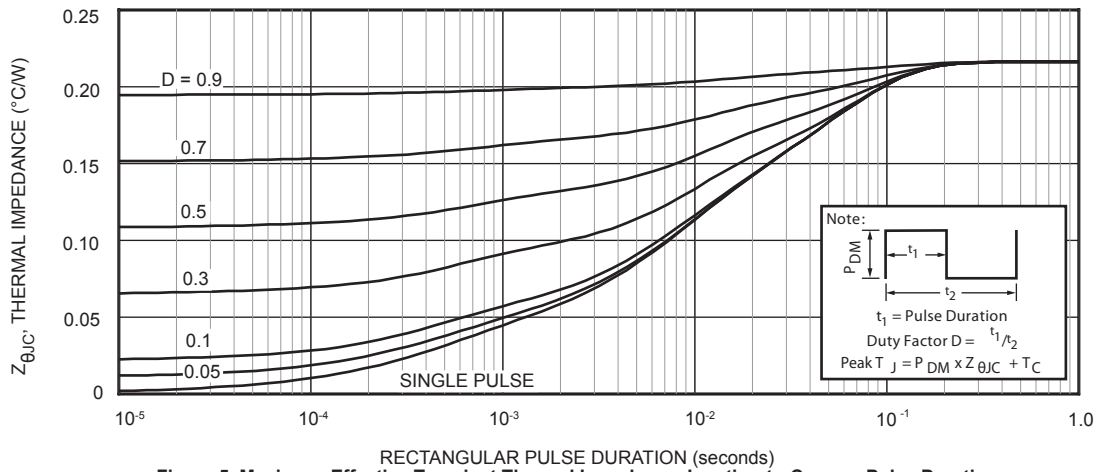

Figure 5. Maximum Effective Transient Thermal Impedance Junction-to-Case vs Pulse Duration

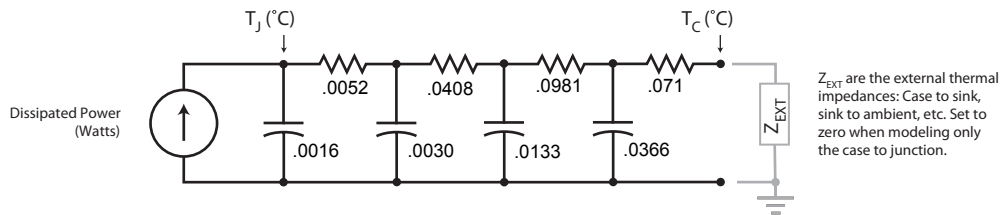

FIGURE 5b, TRANSIENT THERMAL IMPEDANCE MODEL

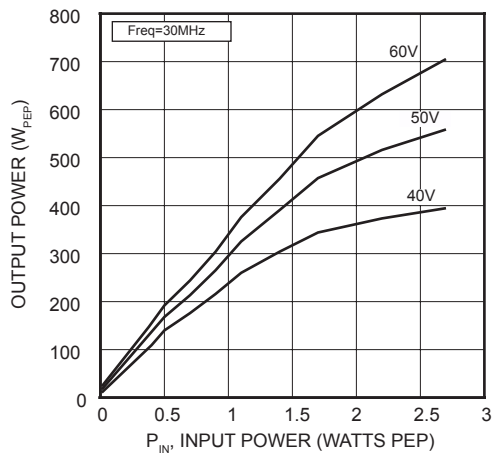

Figure 6. P<sub>OUT</sub> versus P<sub>IN</sub>

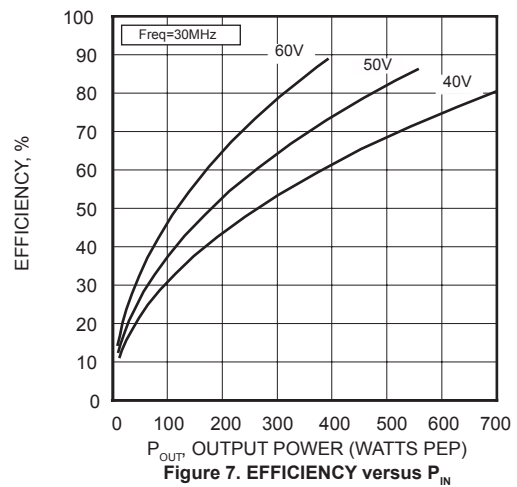

Figure 7. EFFICIENCY versus P<sub>IN</sub>

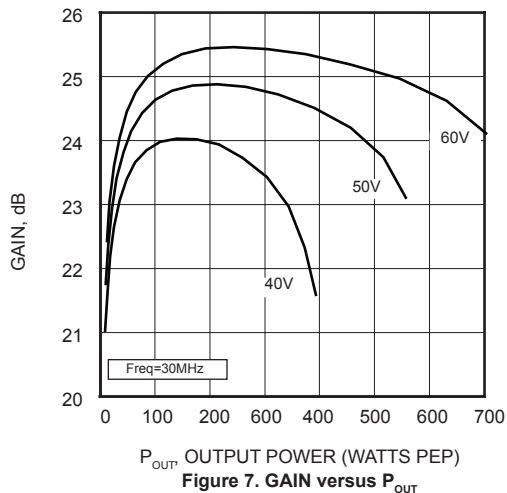

Figure 7. GAIN versus P<sub>OUT</sub>

Table 1 - Typical Class AB Large Signal Input - Output Impedance

Freq. (MHz)	$Z_{in}$	$Z_{out}$
30	$4.5 - j 2.5$	$2.15 - j 2.71$

$I_{dq} = 100\text{mA}$      $Z_{ol}$  - Conjugate of optimum load for 400 Watts output at  $V_{dd}=150\text{V}$

## 30 MHz Test Circuit

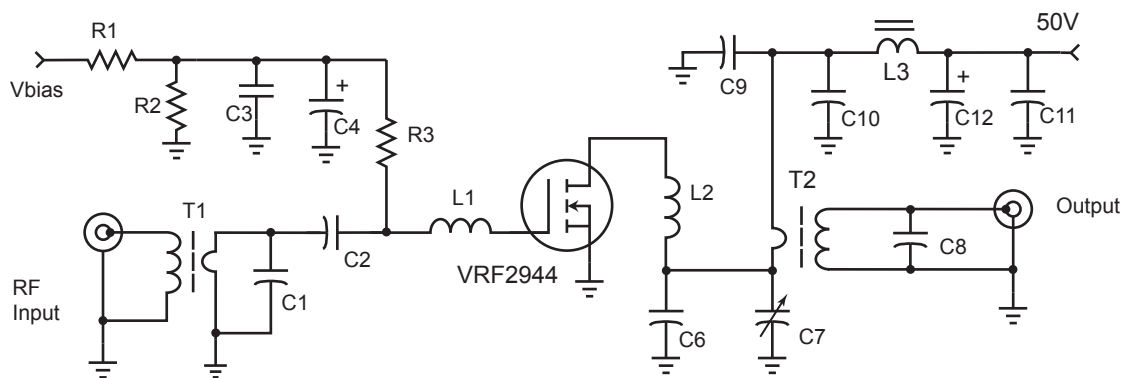

C1 1200pF ATC100B ceramic  
 C2, C3 0.1uF 100V 1206 SMT  
 C9-C11 .047uF NPO 100V 1218 SMT  
 C6 180 pF metal clad mica  
 C7 ARCO 465 mica trimmer  
 C8 100 pF ATC 100E ceramic  
 C4, C12 10uF 100V Electrolytic  
 L1 25 nH - 2t #18 0.2"d .2"l

L2 26 nH - 1.5t #12 0.31"d2  
 L3 2t #16 on 2x 267300081 .5" bead  
 R1-R2 1k  $\Omega$  1/4W  
 R3 100  $\Omega$  1W  
 T1 16:1 transformer 4t #24 teflon on  
 RF Parts Co. T1/2 transformer core  
 T2 9:1 transformer 3t 2-ply #16 teflon on  
 RF Parts Co. T1 transformer core

Adding MP at the end of P/N specifies a matched pair where  $V_{GS(TH)}$  is matched between the two parts.  $V_{TH}$  values are marked on the devices per the following table.

Code	Vth Range	Code 2	Vth Range
A	2.900 - 2.975	M	3.650 - 3.725
B	2.975 - 3.050	N	3.725 - 3.800
C	3.050 - 3.125	P	3.800 - 3.875
D	3.125 - 3.200	R	3.875 - 3.950
E	3.200 - 3.275	S	3.950 - 4.025
F	3.275 - 3.350	T	4.025 - 4.100
G	3.350 - 3.425	W	4.100 - 4.175
H	3.425 - 3.500	X	4.175 - 4.250
J	3.500 - 3.575	Y	4.250 - 4.325
K	3.575 - 3.650	Z	4.325 - 4.400

$V_{TH}$  values are based on Microsemi measurements at datasheet conditions with an accuracy of 1.0%.

**M177 (0.63 dia. SOE) Mechanical Data**  
**All dimensions are  $\pm .005$**

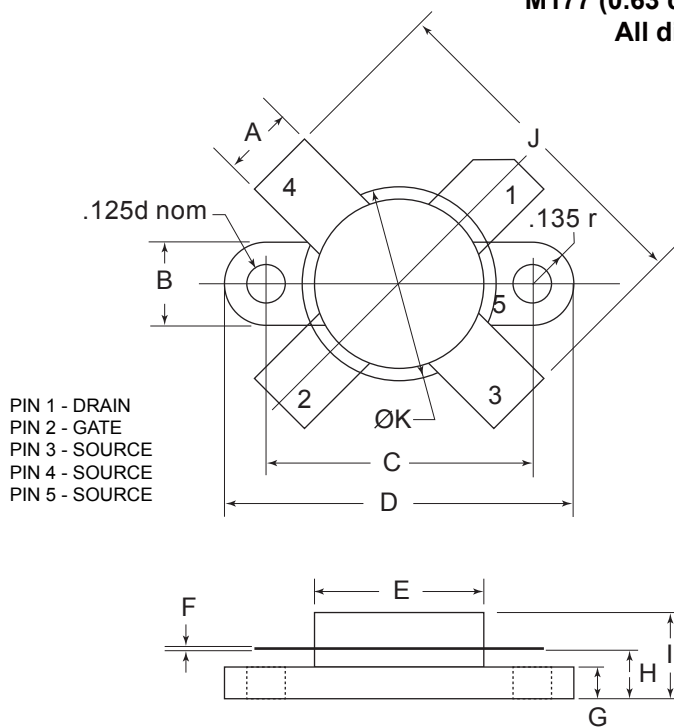

DIM	MIN	TYP	MAX
A	0.225	0.230	0.235
B	0.265	0.270	0.275
C	0.860	0.865	0.870
D	1.130	1.135	1.140
E	0.545	0.550	0.555
F	0.003	0.005	0.007
G	0.098	0.103	0.108
H	0.150	0.160	0.170
I			0.280
J	1.080	1.100	1.120
K	0.625	0.630	0.635

**HAZARDOUS MATERIAL WARNING:** The ceramic portion of the device below the lead plane is beryllium oxide. Beryllium oxide dust is highly toxic when inhaled. Care must be taken during handling and mounting to avoid damage to this area. These devices must never be thrown away with general industrial or domestic waste. BeO substrate weight: 0.703g. Percentage of total module weight which is BeO: 9%.

**Disclaimer:**

The information contained in the document (unless it is publicly available on the Web without access restrictions) is PROPRIETARY AND CONFIDENTIAL information of Microsemi and cannot be copied, published, uploaded, posted, transmitted, distributed or disclosed or used without the express duly signed written consent of Microsemi. If the recipient of this document has entered into a disclosure agreement with Microsemi, then the terms of such Agreement will also apply. This document and the information contained herein may not be modified, by any person other than authorized personnel of Microsemi. No license under any patent, copyright, trade secret or other intellectual property right is granted to or conferred upon you by disclosure or delivery of the information, either expressly, by implication, inducement, estoppels or otherwise. Any license under such intellectual property rights must be approved by Microsemi in writing signed by an officer of Microsemi.

Microsemi reserves the right to change the configuration, functionality and performance of its products at anytime without any notice. This product has been subject to limited testing and should not be used in conjunction with life-support or other mission-critical equipment or applications. Microsemi assumes no liability whatsoever, and Microsemi disclaims any express or implied warranty, relating to sale and/or use of Microsemi products including liability or warranties relating to fitness for a particular purpose, merchantability, or infringement of any patent, copyright or other intellectual property right. Any performance specifications believed to be reliable but are not verified and customer or user must conduct and complete all performance and other testing of this product as well as any user or customers final application. User or customer shall not rely on any data and performance specifications or parameters provided by Microsemi. It is the customer's and user's responsibility to independently determine suitability of any Microsemi product and to test and verify the same. The information contained herein is provided "AS IS, WHERE IS" and with all faults, and the entire risk associated with such information is entirely with the User. Microsemi specifically disclaims any liability of any kind including for consequential, incidental and punitive damages as well as lost profit. The product is subject to other terms and conditions which can be located on the web at <http://www.microsemi.com/legal/tnc.asp>

Компания «Океан Электроники» предлагает заключение долгосрочных отношений при поставках импортных электронных компонентов на взаимовыгодных условиях!

Наши преимущества:

- Поставка оригинальных импортных электронных компонентов напрямую с производств Америки, Европы и Азии, а так же с крупнейших складов мира;
- Широкая линейка поставок активных и пассивных импортных электронных компонентов (более 30 млн. наименований);
- Поставка сложных, дефицитных, либо снятых с производства позиций;
- Оперативные сроки поставки под заказ (от 5 рабочих дней);
- Экспресс доставка в любую точку России;
- Помощь Конструкторского Отдела и консультации квалифицированных инженеров;
- Техническая поддержка проекта, помощь в подборе аналогов, поставка прототипов;
- Поставка электронных компонентов под контролем ВП;
- Система менеджмента качества сертифицирована по Международному стандарту ISO 9001;
- При необходимости вся продукция военного и аэрокосмического назначения проходит испытания и сертификацию в лаборатории (по согласованию с заказчиком);
- Поставка специализированных компонентов военного и аэрокосмического уровня качества (Xilinx, Altera, Analog Devices, Intersil, Interpoint, Microsemi, Actel, Aeroflex, Peregrine, VPT, Syfer, Eurofarad, Texas Instruments, MS Kennedy, Miteq, Cobham, E2V, MA-COM, Hittite, Mini-Circuits, General Dynamics и др.);

Компания «Океан Электроники» является официальным дистрибьютором и эксклюзивным представителем в России одного из крупнейших производителей разъемов военного и аэрокосмического назначения «JONHON», а так же официальным дистрибьютором и эксклюзивным представителем в России производителя высокотехнологичных и надежных решений для передачи СВЧ сигналов «FORSTAR».



## JONHON

«JONHON» (основан в 1970 г.)

Разъемы специального, военного и аэрокосмического назначения:

(Применяются в военной, авиационной, аэрокосмической, морской, железнодорожной, горно- и нефтедобывающей отраслях промышленности)

«FORSTAR» (основан в 1998 г.)

ВЧ соединители, коаксиальные кабели, кабельные сборки и микроволновые компоненты:

(Применяются в телекоммуникациях гражданского и специального назначения, в средствах связи, РЛС, а так же военной, авиационной и аэрокосмической отраслях промышленности).



Телефон: 8 (812) 309-75-97 (многоканальный)

Факс: 8 (812) 320-03-32

Электронная почта: [ocean@oceanchips.ru](mailto:ocean@oceanchips.ru)

Web: <http://oceanchips.ru/>

Адрес: 198099, г. Санкт-Петербург, ул. Калинина, д. 2, корп. 4, лит. А