

WINNIE-M

~35° medium beam. Holder with 35 mm screw hole distance according to Zhaga standard. Compatible with Bender+Wirth 4xx Typ L5 connector.

TECHNICAL SPECIFICATIONS:

| | |
|----------------|--|
| Dimensions | Ø 49.8 mm |
| Height | 19.3 mm |
| Fastening | screw |
| ROHS compliant | yes  |

MATERIAL SPECIFICATIONS:

| Component | Type | Material | Colour | Finish |
|---------------|-------------|----------|--------|--------|
| WINNIE-M | Single lens | PMMA | clear | |
| WINNIE-HOLDER | Holder | PC | white | |

ORDERING INFORMATION:

| Component | | Qty in box | MOQ | MPQ | Box weight (kg) |
|------------------|-------------|------------|-----|-----|-----------------|
| CN14237_WINNIE-M | Single lens | 364 | 84 | 28 | 0.0 |
| » Box size: | | | | | |



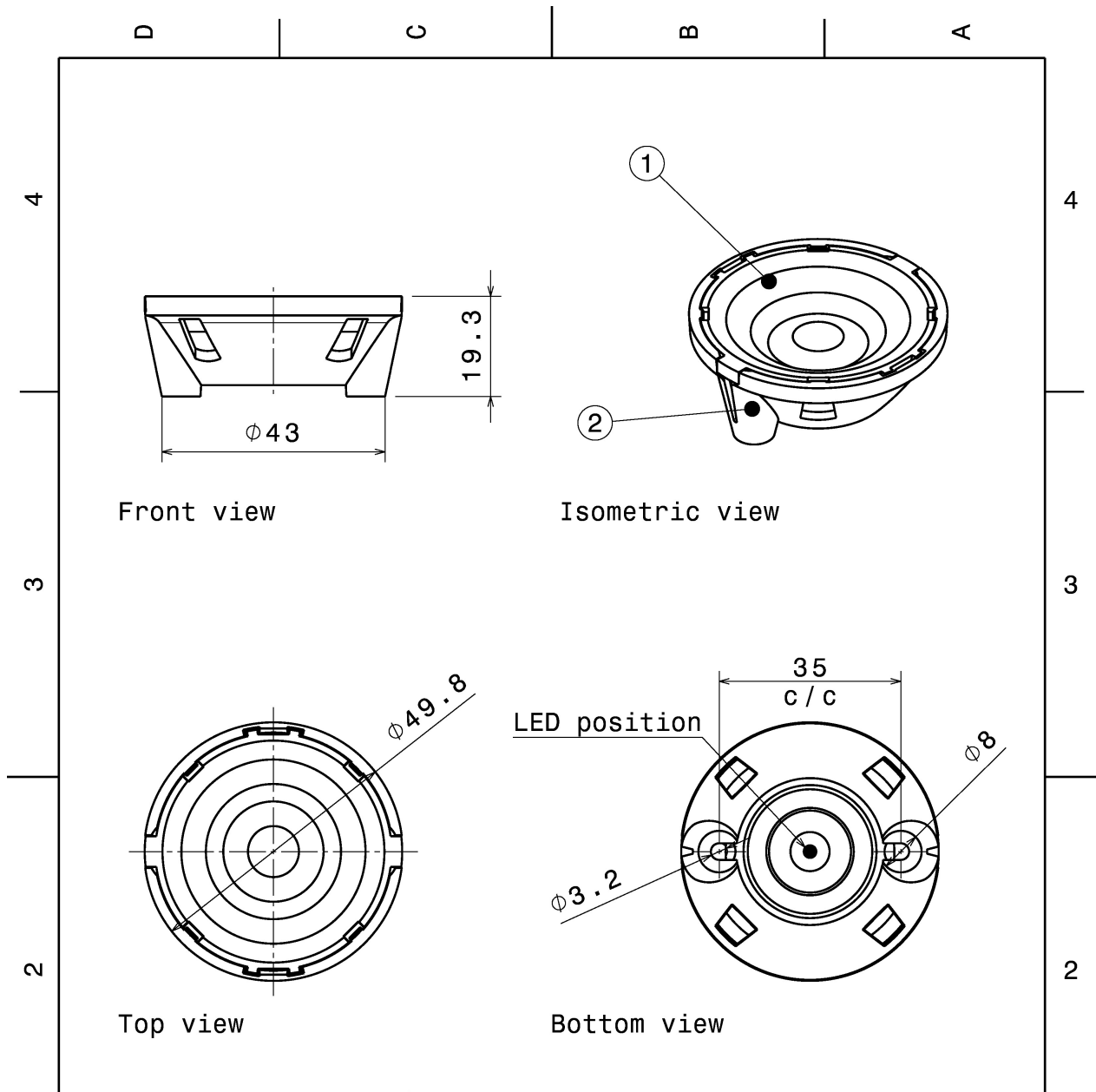

| INDEX | PART NO | DESCRIPTION | MATERIAL | COLOUR |
|-------|---------|---------------|----------|--------|
| 1 | C14233 | WINNIE-M | PMMA | clear |
| 2 | C14235 | WINNIE-HOLDER | PC | white |

Tolerances if not otherwise shown
According to DIN ISO 2768-1
Linear measures:
Up to 30mm class M, otherwise class C
According to DIN ISO 2768-2
Form and position: class L

LEDiL

Ledil Oy
Salorankatu 10
FIN 24240 SALO
Finland

THIRD ANGLE PROJECTION:

DRAWING TITLE

CN14237_WINNIE-M

This drawing is the property of LEDiL Oy. It may not be reproduced, copied or communicated without a written agreement with LEDiL Oy.

SIZE PART NUMBER

A4

CN14237

SCALE 1:1 WEIGHT 17,74 g SHEET 1/1

PHOTOMETRIC DATA (MEASURED):

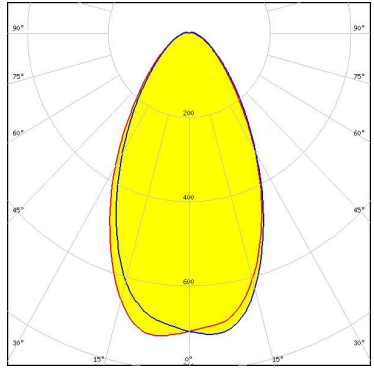
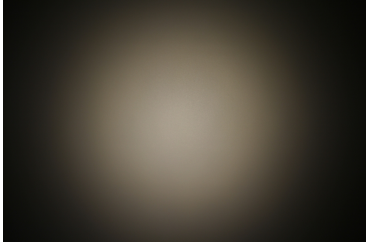
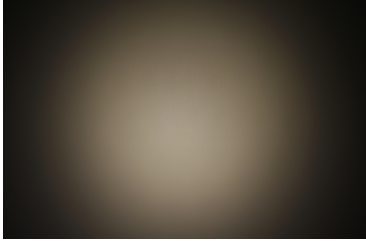
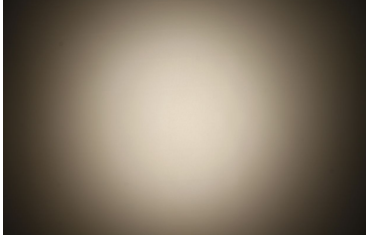
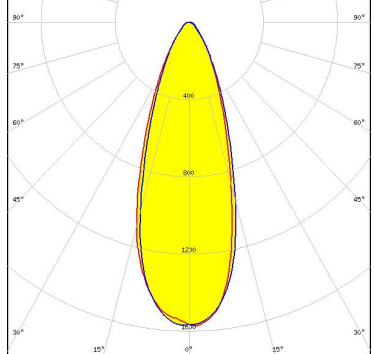
| | | |
|---|--|---|
| <p>bridgelux.</p> <p>LED V18 Gen6</p> <p>FWHM 58.0°</p> <p>Efficiency 88 %</p> <p>Peak intensity 0.7 cd/lm</p> <p>LEDs/each optic 1</p> <p>Light colour White</p> <p>Required components:</p> |  |  |
| <p>bridgelux.</p> <p>LED V6 Gen6</p> <p>FWHM 27.0°</p> <p>Efficiency 86 %</p> <p>Peak intensity 2.4 cd/lm</p> <p>LEDs/each optic 1</p> <p>Light colour White</p> <p>Required components:</p> |  | |
| <p>bridgelux.</p> <p>LED V8 Gen6</p> <p>FWHM 31.0°</p> <p>Efficiency 85 %</p> <p>Peak intensity 1.8 cd/lm</p> <p>LEDs/each optic 1</p> <p>Light colour White</p> <p>Required components:</p> |  | |
| <p>bridgelux.</p> <p>LED VERO10</p> <p>FWHM 36.0°</p> <p>Efficiency 89 %</p> <p>Peak intensity 1.6 cd/lm</p> <p>LEDs/each optic 1</p> <p>Light colour White</p> <p>Required components:</p> |  |  |

PHOTOMETRIC DATA (MEASURED):

CITIZEN

LED CLL01x
 FWHM 27.0°
 Efficiency 85 %
 Peak intensity 2.4 cd/lm
 LEDs/each optic 1
 Light colour White
 Required components:



CITIZEN

LED CLL02x/CLU02x (LES10)
 FWHM 35.0°
 Efficiency 86 %
 Peak intensity 1.6 cd/lm
 LEDs/each optic 1
 Light colour White
 Required components:
 Bender Wirth: 434 Typ L5

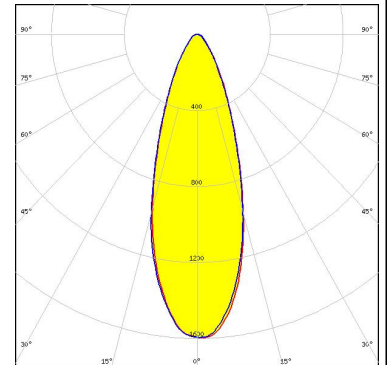
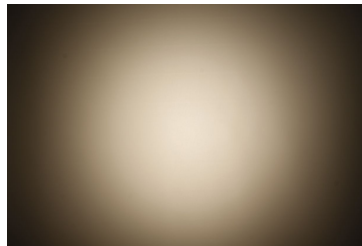

CITIZEN

LED CLL02x/CLU02x (LES10)
 FWHM 35.0°
 Efficiency 87 %
 Peak intensity 2.3 cd/lm
 LEDs/each optic 1
 Light colour White
 Required components:

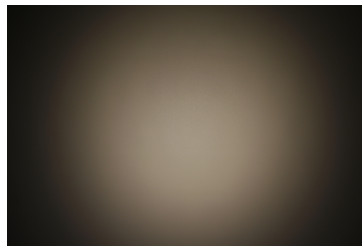

CITIZEN

LED CLL03x/CLU03x
 FWHM 49.0°
 Efficiency 86 %
 Peak intensity 0.9 cd/lm
 LEDs/each optic 1
 Light colour White
 Required components:
 Bender Wirth: 433 Typ L5

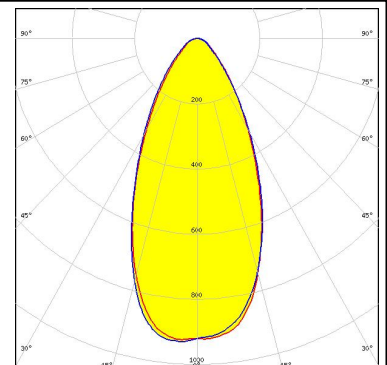
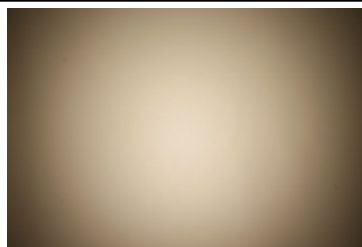

PHOTOMETRIC DATA (MEASURED):

CITIZEN

LED CLU700/701/702
 FWHM 28.0°
 Efficiency 87 %
 Peak intensity 2.4 cd/lm
 LEDs/each optic 1
 Light colour White
 Required components:
 Bender Wirth: 434 Typ L5

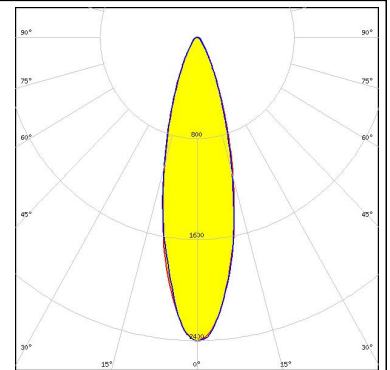
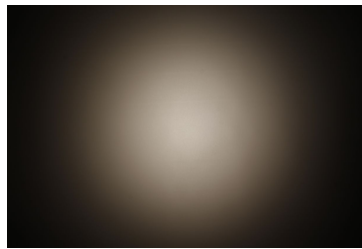

CITIZEN

LED CLU700/701/702
 FWHM 27.0°
 Efficiency 89 %
 Peak intensity 2.6 cd/lm
 LEDs/each optic 1
 Light colour White
 Required components:

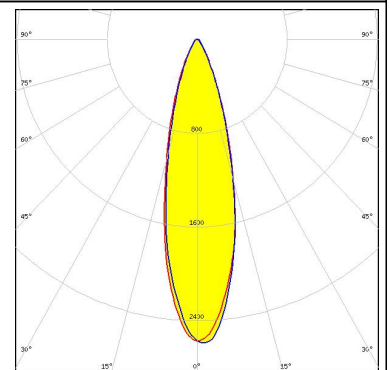
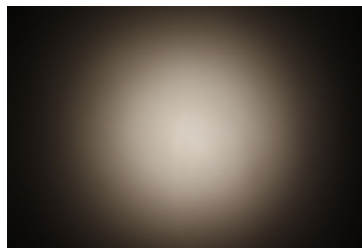

CITIZEN

LED CLU710/711
 FWHM 32.0°
 Efficiency 86 %
 Peak intensity 1.7 cd/lm
 LEDs/each optic 1
 Light colour White
 Required components:

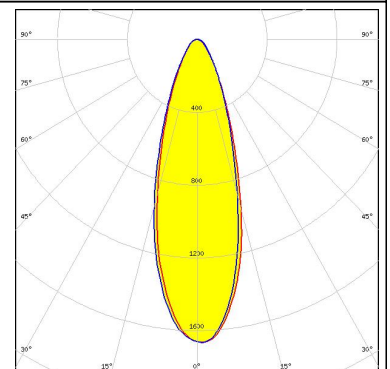
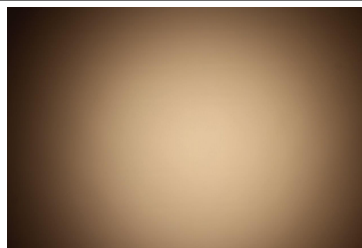

CITIZEN

LED CLU710/711
 FWHM 33.0°
 Efficiency 87 %
 Peak intensity 1.8 cd/lm
 LEDs/each optic 1
 Light colour White
 Required components:
 Bender Wirth: 470 Typ L5

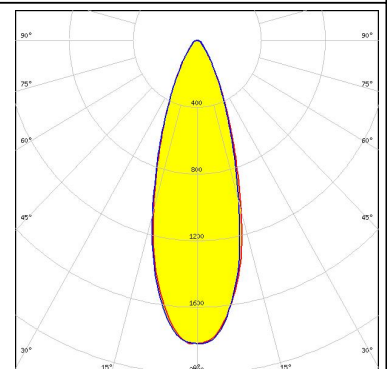
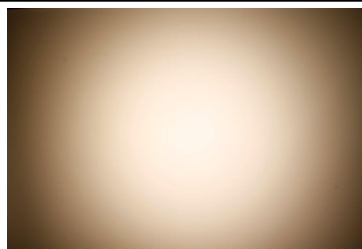

PHOTOMETRIC DATA (MEASURED):

CITIZEN

LED CLU720/721
 FWHM 41.0°
 Efficiency 90 %
 Peak intensity 1.3 cd/lm
 LEDs/each optic 1
 Light colour White
 Required components:
 Bender Wirth: 433 Typ L5

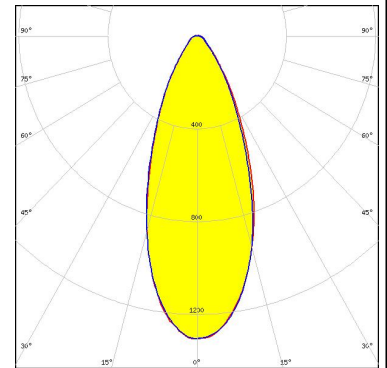
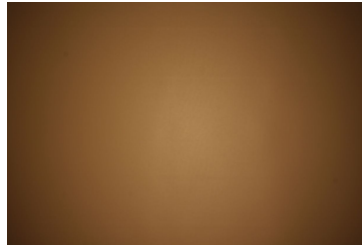

CREE

LED CXA/B 13xx
 FWHM 26.0°
 Efficiency 87 %
 Peak intensity 2.8 cd/lm
 LEDs/each optic 1
 Light colour White
 Required components:

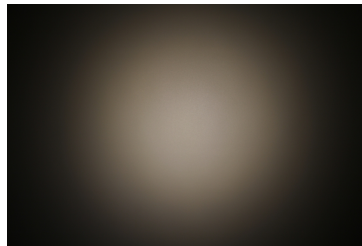

CREE

LED CXA/B 13xx
 FWHM 25.0°
 Efficiency 88 %
 Peak intensity 2.7 cd/lm
 LEDs/each optic 1
 Light colour White
 Required components:

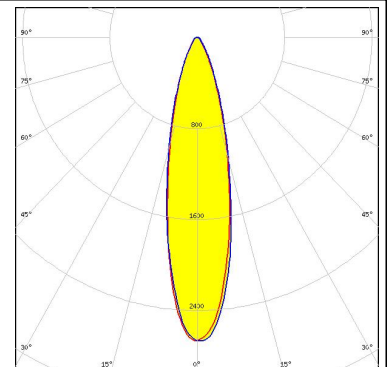
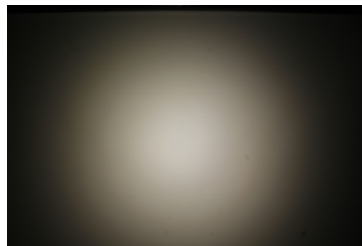

CREE

LED CXA/B 15xx
 FWHM 31.0°
 Efficiency 86 %
 Peak intensity 2.1 cd/lm
 LEDs/each optic 1
 Light colour White
 Required components:

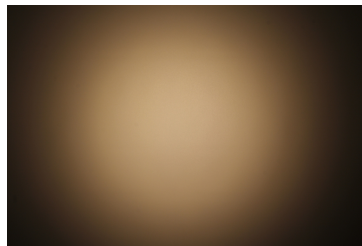

PHOTOMETRIC DATA (MEASURED):



LED CXA/B 25xx
 FWHM 55.0°
 Efficiency 85 %
 Peak intensity 0.8 cd/lm
 LEDs/each optic 1
 Light colour White
 Required components:

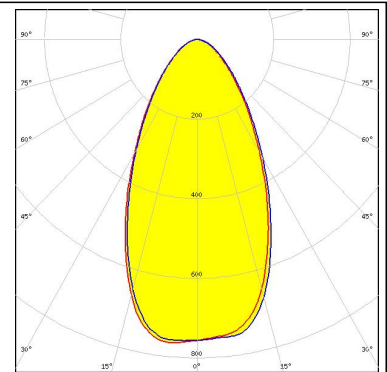
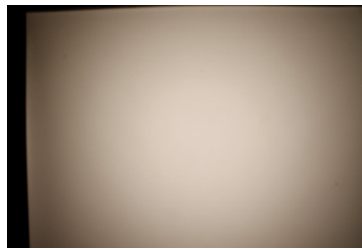

LED MHD-E/G
 FWHM 30.0°
 Efficiency 87 %
 Peak intensity 1.9 cd/lm
 LEDs/each optic 1
 Light colour White
 Required components:

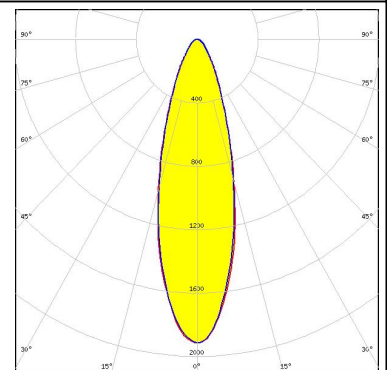
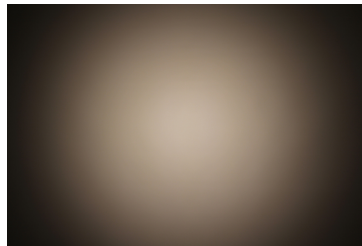

LED LUXEON CoB 1202/1203
 FWHM 34.0°
 Efficiency 86 %
 Peak intensity 1.7 cd/lm
 LEDs/each optic 1
 Light colour White
 Required components:

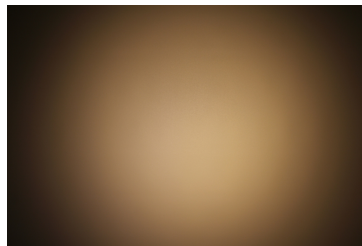

LED LUXEON CoB 1202s
 FWHM 27.0°
 Efficiency 86 %
 Peak intensity 2.5 cd/lm
 LEDs/each optic 1
 Light colour White
 Required components:

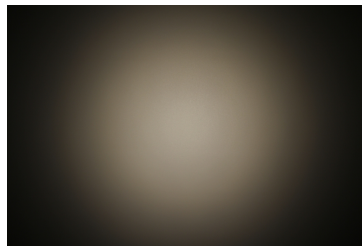

PHOTOMETRIC DATA (MEASURED):



LED CxM-14 (19x19)
FWHM 45.0°
Efficiency 85 %
Peak intensity 1 cd/lm
LEDs/each optic 1
Light colour White
Required components:

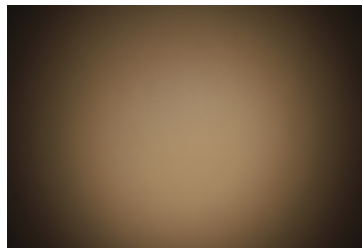

LED CxM-9 (13.5x13.5)
FWHM 36.0°
Efficiency 87 %
Peak intensity 1.7 cd/lm
LEDs/each optic 1
Light colour White
Required components:

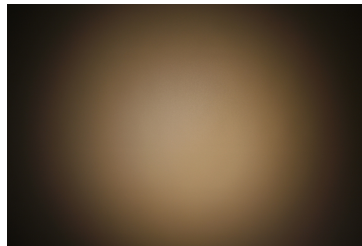

Osram Semiconductors

LED Duris S10
FWHM 24.0°
Efficiency 88 %
Peak intensity 3.1 cd/lm
LEDs/each optic 1
Light colour White
Required components:

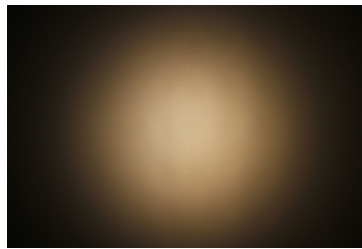

Osram Semiconductors

LED Soleriq S13
FWHM 41.0°
Efficiency 85 %
Peak intensity 1.2 cd/lm
LEDs/each optic 1
Light colour White
Required components:

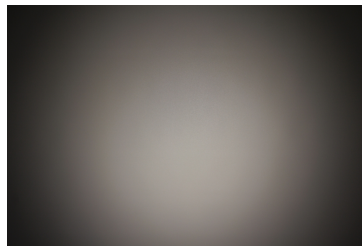

PHOTOMETRIC DATA (MEASURED):

OSRAM
Opto Semiconductors

LED Soleriq S19
 FWHM 55.0°
 Efficiency 83 %
 Peak intensity 0.8 cd/lm
 LEDs/each optic 1
 Light colour White
 Required components:

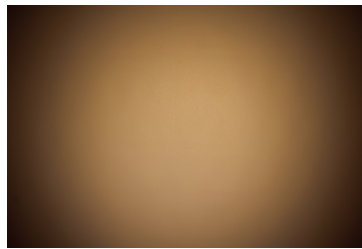

SAMSUNG

LED LC003D / LC006D / LC009D / LC013D
 FWHM 35.0°
 Efficiency 87 %
 Peak intensity 1.6 cd/lm
 LEDs/each optic 1
 Light colour White
 Required components:

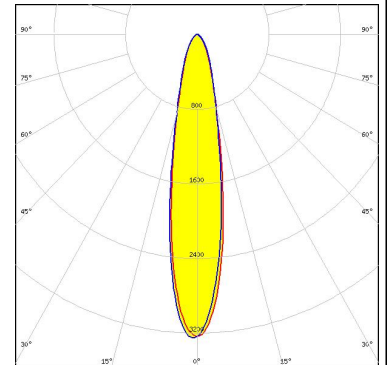
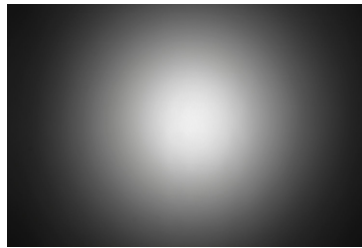

SAMSUNG

LED LC016D / LC019D / LC026D / LC033D
 FWHM 48.0°
 Efficiency 85 %
 Peak intensity 0.9 cd/lm
 LEDs/each optic 1
 Light colour White
 Required components:

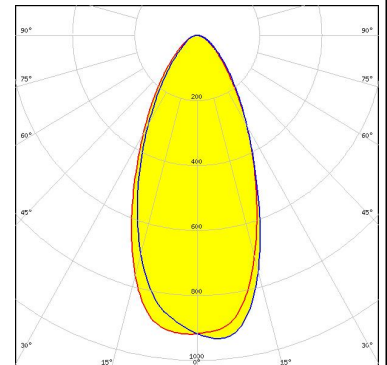
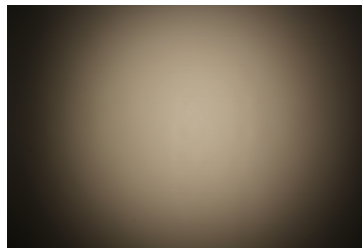

SEOUL SEMICONDUCTOR

LED MJT COB LES 14.5
 FWHM 51.0°
 Efficiency 84 %
 Peak intensity 0.9 cd/lm
 LEDs/each optic 1
 Light colour White
 Required components:
 Bender Wirth: 433 Typ L5

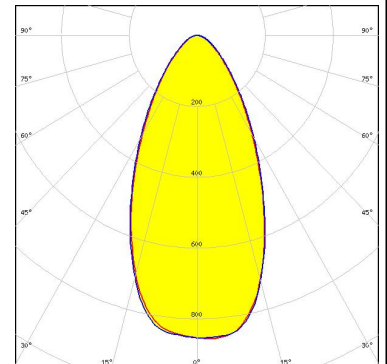
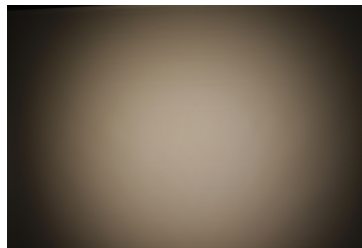

PHOTOMETRIC DATA (MEASURED):

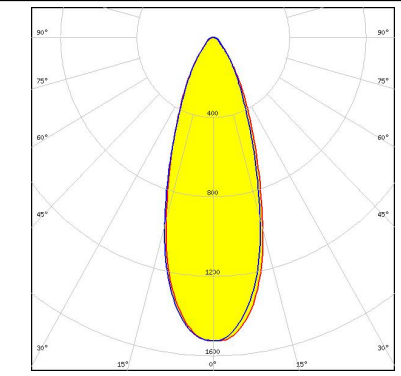
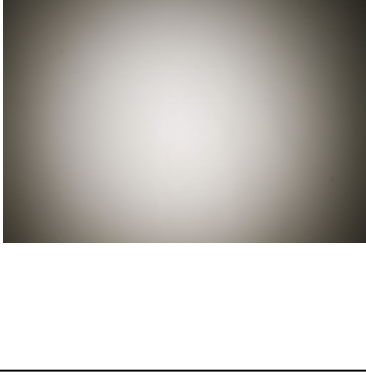
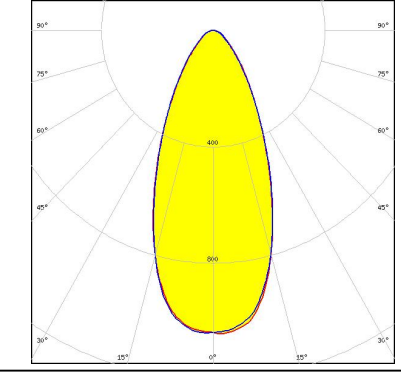
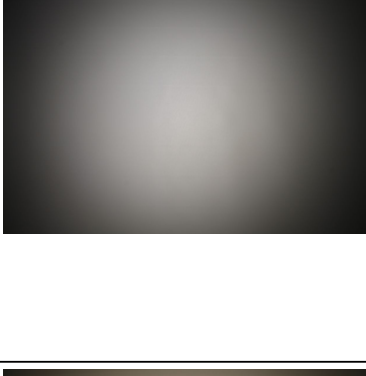
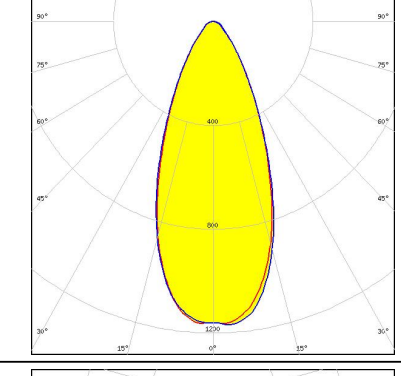
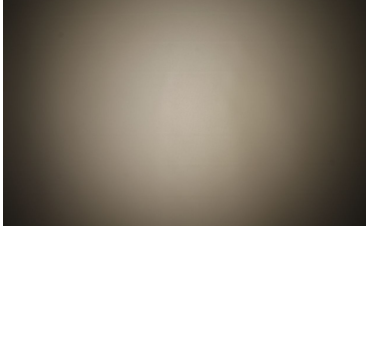
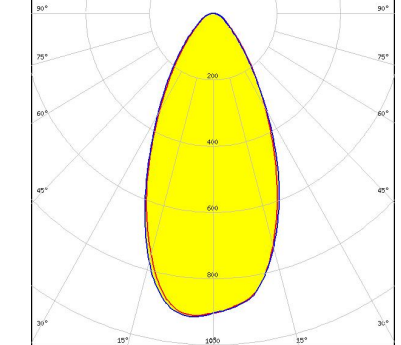
| | | |
|--|--|---|
| <p>SEOL SEOUL SEMICONDUCTOR</p> <p>LED MJT COB LES 9.8 FWHM 36.0° Efficiency 89 % Peak intensity 1.5 cd/lm LEDs/each optic 1 Light colour White Required components: Bender Wirth: 434 Typ L5</p> |  |  |
| <p>SEOL SEOUL SEMICONDUCTOR</p> <p>LED ZC12/18 FWHM 46.0° Efficiency 87 % Peak intensity 1 cd/lm LEDs/each optic 1 Light colour White Required components: Bender Wirth: 433 Typ L5</p> |  |  |
| <p>VS LIGHTING SOLUTIONS</p> <p>LED DMC 124 / 125 FWHM 44.0° Efficiency 88 % Peak intensity 1.2 cd/lm LEDs/each optic 1 Light colour White Required components: Bender Wirth: 433 Typ L5</p> |  |  |
| <p>VS LIGHTING SOLUTIONS</p> <p>LED DMC 128 FWHM 50.0° Efficiency 87 % Peak intensity 0.9 cd/lm LEDs/each optic 1 Light colour White Required components: Bender Wirth: 433 Typ L5</p> |  |  |

PHOTOMETRIC DATA (SIMULATED):

CITIZEN

LED CLL02x/CLU02x (LES10)
FWHM 35.0°
Efficiency 92 %
Peak intensity 1.8 cd/lm
LEDs/each optic 1
Light colour White
Required components:

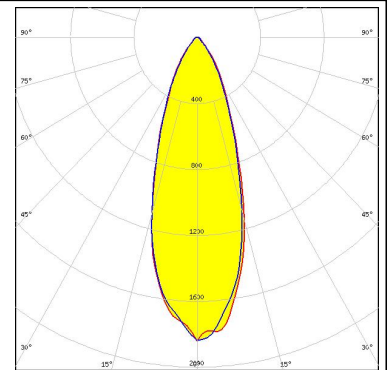

LUMILEDS

LED LUXEON CoB 1202/1203
FWHM 34.0°
Efficiency 89 %
Peak intensity 1.9 cd/lm
LEDs/each optic 1
Light colour White
Required components:
Bender Wirth: 441 Typ L5

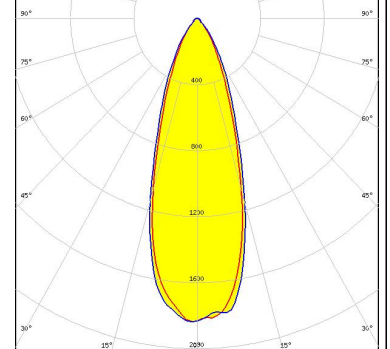

LUMILEDS

LED LUXEON CoB Compact
FWHM 27.0°
Efficiency 86 %
Peak intensity 2.5 cd/lm
LEDs/each optic 1
Light colour White
Required components:

LUMINUS

LED CxM-14 (19x19)
FWHM 49.0°
Efficiency 86 %
Peak intensity 0.9 cd/lm
LEDs/each optic 1
Light colour White
Required components:
Bender Wirth: 433 Typ L5

PHOTOMETRIC DATA (SIMULATED):



LED CxM-9 (13.5x13.5)
FWHM 35.0°
Efficiency 86 %
Peak intensity 1.6 cd/lm
LEDs/each optic 1
Light colour White
Required components:
Bender Wirth: 434 Typ L5



LED COB S-Type (LES 6)
FWHM 25.0°
Efficiency 92 %
Peak intensity 3.3 cd/lm
LEDs/each optic 1
Light colour White
Required components:

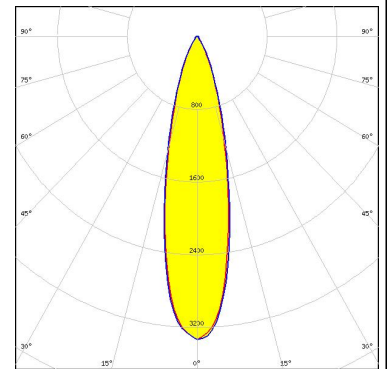

LED Soleriq S9
FWHM 32.0°
Efficiency 90 %
Peak intensity 1.9 cd/lm
LEDs/each optic 1
Light colour White
Required components:

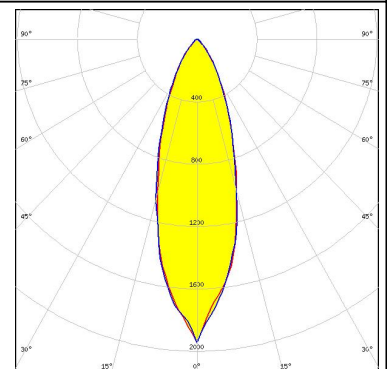

LED LC010C
FWHM 27.0°
Efficiency 92 %
Peak intensity 3 cd/lm
LEDs/each optic 1
Light colour White
Required components:
Bender Wirth: 479 Typ L5

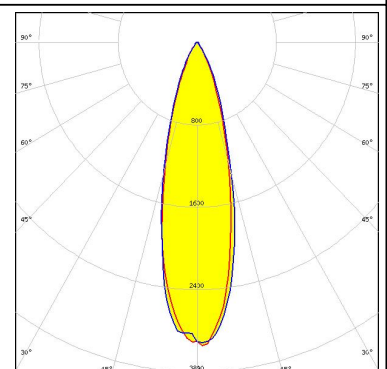

PHOTOMETRIC DATA (SIMULATED):

SAMSUNG

LED LC020C
FWHM 32.0°
Efficiency 90 %
Peak intensity 2.1 cd/lm
LEDs/each optic 1
Light colour White
Required components:
Bender Wirth: 479 Typ L5

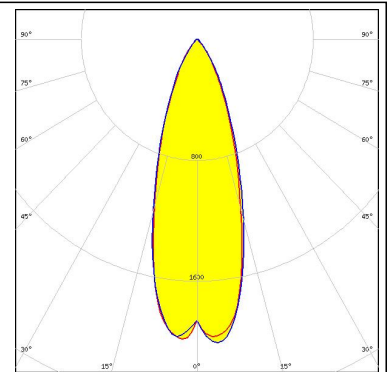

SAMSUNG

LED LC040C
FWHM 40.0°
Efficiency 89 %
Peak intensity 1.4 cd/lm
LEDs/each optic 1
Light colour White
Required components:
Bender Wirth: 479 Typ L5

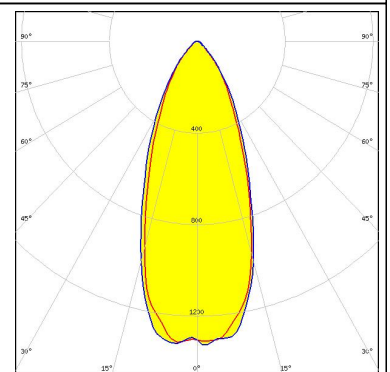

SEOUL SEMICONDUCTOR

LED ZC4/6
FWHM 35.0°
Efficiency 86 %
Peak intensity 1.6 cd/lm
LEDs/each optic 1
Light colour White
Required components:
Bender Wirth: 434 Typ L5

GENERAL INFORMATION:

NOTE: The typical beam angle will be changed by different color, chip size and chip position tolerance. The typical total beam angle is the full angle measured where the luminous intensity is half of the peak value.

Due to use of high power COB's with this product, special attention to proper thermal design is highly recommended. LEDiL has no liability for direct, indirect or consecutive damages arising from the LEDiL products being used outside of the recommended temperature range.

MATERIALS:

As part of our continuous research and improvement processes, and to ensure the best possible quality and availability of our products, LEDiL reserves the right to change material grades without notice.

PRODUCT DATA USER AGREEMENT AND DISCLAIMER:

The measured data in the provided downloadable LEDiL Product Datasheets and Mechanical 2D-Drawings is rounded and provided as reference for planning. LEDiL Oy's optical specifications have been verified by conducting performance testing of the products in accordance with the company's quality system. The reported data are averaged results of multiple measurements with typical variation. LEDiL Oy reserves the right to without prior notification make changes and improvements to its products.

LEDiL Oy assumes neither warranty, nor guarantee nor any other liability of any kind for the contents and correctness of the provided data. The provided data has been generated with highest diligence but the provided data may in reality not represent the complete possible variation range of all intrinsic parameters. Therefore, in certain cases a deviation from the provided data could occur.

LEDiL Oy reserves the right to undertake technical changes of its products without further notification which could lead to changes in the provided data. LEDiL Oy assumes no liability of any kind for the possible deviation from any provided data or any other damage resulting from the usage of the provided data.

The user agrees to this disclaimer and user agreement with the download or usage of the provided files.

LEDiL Oy

Joensuunkatu 13
FI-24240 SALO
Finland

LEDiL Inc.

228 West Page Street
Suite D
Sycamore IL 60178
USA

Local sales and technical support

[www.ledil.com/
where_to_buy](http://www.ledil.com/where_to_buy)

Shipping locations

Salo, Finland
Hong Kong, China

Distribution Partners

[www.ledil.com/
where_to_buy](http://www.ledil.com/where_to_buy)

Компания «Океан Электроники» предлагает заключение долгосрочных отношений при поставках импортных электронных компонентов на взаимовыгодных условиях!

Наши преимущества:

- Поставка оригинальных импортных электронных компонентов напрямую с производств Америки, Европы и Азии, а так же с крупнейших складов мира;
- Широкая линейка поставок активных и пассивных импортных электронных компонентов (более 30 млн. наименований);
- Поставка сложных, дефицитных, либо снятых с производства позиций;
- Оперативные сроки поставки под заказ (от 5 рабочих дней);
- Экспресс доставка в любую точку России;
- Помощь Конструкторского Отдела и консультации квалифицированных инженеров;
- Техническая поддержка проекта, помощь в подборе аналогов, поставка прототипов;
- Поставка электронных компонентов под контролем ВП;
- Система менеджмента качества сертифицирована по Международному стандарту ISO 9001;
- При необходимости вся продукция военного и аэрокосмического назначения проходит испытания и сертификацию в лаборатории (по согласованию с заказчиком);
- Поставка специализированных компонентов военного и аэрокосмического уровня качества (Xilinx, Altera, Analog Devices, Intersil, Interpoint, Microsemi, Actel, Aeroflex, Peregrine, VPT, Syfer, Eurofarad, Texas Instruments, MS Kennedy, Miteq, Cobham, E2V, MA-COM, Hittite, Mini-Circuits, General Dynamics и др.);

Компания «Океан Электроники» является официальным дистрибьютором и эксклюзивным представителем в России одного из крупнейших производителей разъемов военного и аэрокосмического назначения «JONHON», а так же официальным дистрибьютором и эксклюзивным представителем в России производителя высокотехнологичных и надежных решений для передачи СВЧ сигналов «FORSTAR».



JONHON

«JONHON» (основан в 1970 г.)

Разъемы специального, военного и аэрокосмического назначения:

(Применяются в военной, авиационной, аэрокосмической, морской, железнодорожной, горно- и нефтедобывающей отраслях промышленности)

«FORSTAR» (основан в 1998 г.)

ВЧ соединители, коаксиальные кабели,
кабельные сборки и микроволновые компоненты:

(Применяются в телекоммуникациях гражданского и специального назначения, в средствах связи, РЛС, а так же военной, авиационной и аэрокосмической отраслях промышленности).



Телефон: 8 (812) 309-75-97 (многоканальный)

Факс: 8 (812) 320-03-32

Электронная почта: ocean@oceanchips.ru

Web: <http://oceanchips.ru/>

Адрес: 198099, г. Санкт-Петербург, ул. Калинина, д. 2, корп. 4, лит. А