

EL5120, EL5220, EL5420

12MHz Rail-to-Rail Input-Output Op Amps

FN7186
Rev 8.00
October 15, 2015

The EL5120, EL5220, and EL5420 are low power, high voltage, rail-to-rail input-output amplifiers. The EL5120 contains a single amplifier, the EL5220 contains two amplifiers, and the EL5420 contains four amplifiers. Operating on supplies ranging from 5V to 15V, while consuming only 500 μ A per amplifier, the EL5120, EL5220, and EL5420 have a bandwidth of 12MHz (-3dB). They also provide common mode input ability beyond the supply rails, as well as rail-to-rail output capability. This enables these amplifiers to offer maximum dynamic range at any supply voltage.

The EL5120, EL5220, and EL5420 also feature fast slewing and settling times, as well as a high output drive capability of 30mA (sink and source). These features make these amplifiers ideal for use as voltage reference buffers in Thin Film Transistor Liquid Crystal Displays (TFT-LCD). Other applications include battery power, portable devices, and anywhere low power consumption is important.

The EL5420 is available in the space-saving 14 Ld TSSOP package, the industry-standard 14 Ld SOIC package, as well as the 16 Ld QFN package. The EL5220 is available in the 8 Ld MSOP package and the 8Ld DFN package. The EL5120 is available in the 5 Ld TSOT package. All feature a standard operational amplifier pin out. These amplifiers are specified for operation with an ambient and junction temperature range of -40°C to +125°C.

Features

- 12MHz -3dB Bandwidth
- Supply Voltage = 4.5V to 16.5V
- Low Supply Current (per Amplifier) = 500 μ A
- High Slew Rate = 10V/ μ s
- Unity-Gain Stable
- Beyond the Rails Input Capability
- Rail-to-Rail Output Swing
- Ultra-Small Package
- Pb-Free Available (RoHS Compliant)

Applications

- TFT-LCD Drive Circuits
- Electronics Notebooks
- Electronics Games
- Touch-Screen Displays
- Personal Communication Devices
- Personal Digital Assistants (PDA)
- Portable Instrumentation
- Sampling ADC Amplifiers
- Wireless LANs
- Office Automation
- Active Filters
- ADC/DAC Buffer

Ordering Information

| PART NUMBER (Note 3) | PART MARKING | TEMP. RANGE (°C) | PACKAGE | PKG. DWG. # |
|---|-----------------|---------------------|-------------------------------------|-------------|
| EL5120IWT-T7 (Notes 1, 4) (No longer available or supported) | K | -40 to +125 | 5 Ld TSOT Tape and Reel | MDP0049 |
| EL5220ILZ-T13 (Notes 1, 2, 4) (No longer available or supported) | 20Z | -40 to +125 | 8 Ld DFN Tape and Reel (Pb-Free) | L8.2x3 |
| EL5220CYZ (Note 2) | BBAAA | -40 to +125 | 8 Ld MSOP (Pb-Free) | MDP0043 |
| EL5220CYZ-T7 (Notes 1, 2) | BBAAA | -40 to +125 | 8 Ld MSOP Tape and Reel (Pb-Free) | MDP0043 |
| EL5220CYZ-T13 (Notes 1, 2) | BBAAA | -40 to +125 | 8 Ld MSOP Tape and Reel (Pb-Free) | MDP0043 |
| EL5420CLZ (Note 2) (No longer available or supported) | 5420CLZ | -40 to +125 | 16 Ld QFN (Pb-Free) | MDP0046 |
| EL5420CSZ (Note 2) | 5420CSZ | -40 to +125 | 14 Ld SOIC (Pb-Free) | MDP0027 |
| EL5420CSZ-T7 (Notes 1, 2) | 5420CSZ | -40 to +125 | 14 Ld SOIC Tape and Reel (Pb-Free) | MDP0027 |
| EL5420CSZ-T13 (Notes 1, 2) | 5420CSZ | -40 to +125 | 14 Ld SOIC Tape and Reel (Pb-Free) | MDP0027 |
| EL5420CR (Note 4) (No longer available or supported) | 5420CR | -40 to +125 | 14 Ld TSSOP | MDP0044 |
| EL5420CRZ (Note 2) | 5420CRZ | -40 to +125 | 14 Ld TSSOP (Pb-Free) | M14.173 |
| EL5420CRZ-T7 (Notes 1, 2) | 5420CRZ | -40 to +125 | 14 Ld TSSOP Tape and Reel (Pb-Free) | M14.173 |
| EL5420CRZ-T13 (Notes 1, 2) | 5420CRZ | -40 to +125 | 14 Ld TSSOP Tape and Reel (Pb-Free) | M14.173 |

NOTES:

1. Please refer to [TB347](#) for details on reel specifications.
2. These Intersil Pb-free plastic packaged products employ special Pb-free material sets, molding compounds/die attach materials, and 100% matte tin plate plus anneal (e3 termination finish, which is RoHS compliant and compatible with both SnPb and Pb-free soldering operations). Intersil Pb-free products are MSL classified at Pb-free peak reflow temperatures that meet or exceed the Pb-free requirements of IPC/JEDEC J STD-020.
3. For Moisture Sensitivity Level (MSL), please see device information page for [EL5120](#), [EL5220](#), [EL5420](#). For more information on MSL please see tech brief [TB363](#).
4. Not recommended for new designs. Refer to EL5x20T for possible substitutions.

Pinouts

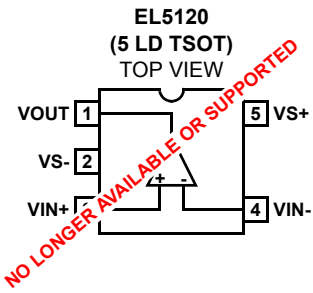

Absolute Maximum Ratings ($T_A = +25^\circ\text{C}$)

| | |
|--|---|
| Supply Voltage between V_{S+} and V_{S-} | +18V |
| Input Voltage | $V_{S-} - 0.5\text{V}$, $V_{S+} + 0.5\text{V}$ |
| Maximum Continuous Output Current | 30mA |

Thermal Information

| | |
|---|---|
| Thermal Resistance (Typical) | θ_{JA} ($^\circ\text{C}/\text{W}$) |
| 5 Ld TSOT (Note 5) | 214 |
| 8 Ld DFN (Note 6) | 55 |
| 8 Ld MSOP (Note 5) | 115 |
| 16 Ld QFN (Note 6) | 44 |
| 14 Ld SOIC (Note 5) | 82 |
| 14 Ld TSSOP (Note 5) | 93 |
| Storage Temperature | -65°C to $+150^\circ\text{C}$ |
| Operating Junction Temperature Range | -40°C to $+125^\circ\text{C}$ |
| Power Dissipation | See Curves |
| Pb-Free Reflow Profile | see link below |
| http://www.intersil.com/pbfree/Pb-FreeReflow.asp | |

CAUTION: Do not operate at or near the maximum ratings listed for extended periods of time. Exposure to such conditions may adversely impact product reliability and result in failures not covered by warranty.

NOTES:

- θ_{JA} is measured with the component mounted on a high effective thermal conductivity test board in free air. See Tech Brief [TB379](#) for details.
- θ_{JA} is measured in free air with the component mounted on a high effective thermal conductivity test board with "direct attach" features. See Tech Brief [TB379](#).

IMPORTANT NOTE: All parameters having Min/Max specifications are guaranteed. Typ values are for information purposes only. Unless otherwise noted, all tests are at the specified temperature and are pulsed tests, therefore: $T_J = T_C = T_A$

Electrical Specifications $V_{S+} = +5\text{V}$, $V_{S-} = -5\text{V}$, $R_L = 10\text{k}\Omega$ and $C_L = 10\text{pF}$ to 0V , $T_A = +25^\circ\text{C}$, unless otherwise specified.

| PARAMETER | DESCRIPTION | CONDITIONS | MIN | TYP | MAX | UNIT |
|---------------------------------|-------------------------------------|--|------|-----------|-------|------------------------------|
| INPUT CHARACTERISTICS | | | | | | |
| V_{OS} | Input Offset Voltage | $V_{CM} = 0\text{V}$ | | 2 | 12 | mV |
| TCV_{OS} | Average Offset Voltage Drift | (Note 7) | | 5 | | $\mu\text{V}/^\circ\text{C}$ |
| I_B | Input Bias Current | $V_{CM} = 0\text{V}$ | | 2 | 50 | nA |
| R_{IN} | Input Impedance | | | 1 | | $\text{G}\Omega$ |
| C_{IN} | Input Capacitance | | | 1.35 | | pF |
| CMIR | Common-Mode Input Range | | -5.5 | | +5.5 | V |
| CMRR | Common-Mode Rejection Ratio | for V_{IN} from -5.5V to $+5.5\text{V}$ | 50 | 70 | | dB |
| A_{VOL} | Open Loop Gain | $-4.5\text{V} \leq V_{OUT} \leq +4.5\text{V}$ | 75 | 95 | | dB |
| OUTPUT CHARACTERISTICS | | | | | | |
| V_{OL} | Output Swing Low | $I_L = -5\text{mA}$ | | -4.92 | -4.85 | V |
| V_{OH} | Output Swing High | $I_L = 5\text{mA}$ | 4.85 | 4.92 | | V |
| I_{SC} | Short Circuit Current | | | ± 120 | | mA |
| I_{OUT} | Output Current | | | ± 30 | | mA |
| POWER SUPPLY PERFORMANCE | | | | | | |
| PSRR | Power Supply Rejection Ratio | V_S is moved from $\pm 2.25\text{V}$ to $\pm 7.75\text{V}$ | 60 | 80 | | dB |
| I_S | Supply Current (Per Amplifier) | No load | | 500 | 750 | μA |
| DYNAMIC PERFORMANCE | | | | | | |
| SR | Slew Rate (Note 8) | $-4.0\text{V} \leq V_{OUT} \leq +4.0\text{V}$, 20% to 80% | | 10 | | $\text{V}/\mu\text{s}$ |
| t_S | Settling to $+0.1\%$ ($A_V = +1$) | ($A_V = +1$), $V_O = 2\text{V}$ step | | 500 | | ns |
| BW | -3dB Bandwidth | $R_L = 10\text{k}\Omega$, $C_L = 10\text{pF}$ | | 12 | | MHz |
| GBWP | Gain-Bandwidth Product | $R_L = 10\text{k}\Omega$, $C_L = 10\text{pF}$ | | 8 | | MHz |
| PM | Phase Margin | $R_L = 10\text{k}\Omega$, $C_L = 10\text{pF}$ | | 50 | | $^\circ$ |
| CS | Channel Separation | $f = 5\text{MHz}$ (EL5220 and EL5420 only) | | 75 | | dB |

NOTES:

- Measured over operating temperature range.
- Slew rate is measured on rising and falling edges.

Electrical Specifications $V_{S+} = +5V$, $V_{S-} = 0V$, $R_L = 10k\Omega$ and $C_L = 10pF$ to 2.5V, $T_A = +25^\circ C$, unless otherwise specified.

| PARAMETER | DESCRIPTION | CONDITIONS | MIN | TYP | MAX | UNIT |
|---------------------------------|----------------------------------|--|------|-----------|------|------------------|
| INPUT CHARACTERISTICS | | | | | | |
| V_{OS} | Input Offset Voltage | $V_{CM} = 2.5V$ | | 2 | 10 | mV |
| TCV_{OS} | Average Offset Voltage Drift | (Note 9) | | 5 | | $\mu V/^\circ C$ |
| I_B | Input Bias Current | $V_{CM} = 2.5V$ | | 2 | 50 | nA |
| R_{IN} | Input Impedance | | | 1 | | $G\Omega$ |
| C_{IN} | Input Capacitance | | | 1.35 | | pF |
| CMIR | Common-Mode Input Range | | -0.5 | | +5.5 | V |
| CMRR | Common-Mode Rejection Ratio | for V_{IN} from -0.5V to +5.5V | 45 | 66 | | dB |
| A_{VOL} | Open Loop Gain | $0.5V \leq V_{OUT} \leq 4.5V$ | 75 | 95 | | dB |
| OUTPUT CHARACTERISTICS | | | | | | |
| V_{OL} | Output Swing Low | $I_L = -5mA$ | | 80 | 150 | mV |
| V_{OH} | Output Swing High | $I_L = +5mA$ | 4.85 | 4.92 | | V |
| I_{SC} | Short Circuit Current | | | ± 120 | | mA |
| I_{OUT} | Output Current | | | ± 30 | | mA |
| POWER SUPPLY PERFORMANCE | | | | | | |
| PSRR | Power Supply Rejection Ratio | V_S is moved from 4.5V to 15.5V | 60 | 80 | | dB |
| I_S | Supply Current (Per Amplifier) | No load | | 500 | 750 | μA |
| DYNAMIC PERFORMANCE | | | | | | |
| SR | Slew Rate (Note 10) | $1V \leq V_{OUT} \leq 4V$, 20% to 80% | | 10 | | $V/\mu s$ |
| t_s | Settling to +0.1% ($A_V = +1$) | ($A_V = +1$), $V_O = 2V$ step | | 500 | | ns |
| BW | -3dB Bandwidth | $R_L = 10k\Omega$, $C_L = 10pF$ | | 12 | | MHz |
| GBWP | Gain-Bandwidth Product | $R_L = 10k\Omega$, $C_L = 10pF$ | | 8 | | MHz |
| PM | Phase Margin | $R_L = 10k\Omega$, $C_L = 10pF$ | | 50 | | $^\circ$ |
| CS | Channel Separation | $f = 5MHz$ (EL5220 and EL5420 only) | | 75 | | dB |

NOTES:

9. Measured over operating temperature range.
10. Slew rate is measured on rising and falling edges.

Electrical Specifications $V_{S+} = +15V$, $V_{S-} = 0V$, $R_L = 10k\Omega$ and $C_L = 10pF$ to 7.5V, $T_A = +25^\circ C$, unless otherwise specified.

| PARAMETER | DESCRIPTION | CONDITIONS | MIN | TYP | MAX | UNIT |
|---------------------------------|----------------------------------|---|-------|-----------|-------|------------------|
| INPUT CHARACTERISTICS | | | | | | |
| V_{OS} | Input Offset Voltage | $V_{CM} = 7.5V$ | | 2 | 14 | mV |
| TCV_{OS} | Average Offset Voltage Drift | (Note 11) | | 5 | | $\mu V/^\circ C$ |
| I_B | Input Bias Current | $V_{CM} = 7.5V$ | | 2 | 50 | nA |
| R_{IN} | Input Impedance | | | 1 | | $G\Omega$ |
| C_{IN} | Input Capacitance | | | 1.35 | | pF |
| CMIR | Common-Mode Input Range | | -0.5 | | +15.5 | V |
| CMRR | Common-Mode Rejection Ratio | for V_{IN} from -0.5V to +15.5V | 53 | 72 | | dB |
| A_{VOL} | Open Loop Gain | $0.5V \leq V_{OUT} \leq 14.5V$ | 75 | 95 | | dB |
| OUTPUT CHARACTERISTICS | | | | | | |
| V_{OL} | Output Swing Low | $I_L = -5mA$ | | 80 | 150 | mV |
| V_{OH} | Output Swing High | $I_L = +5mA$ | 14.85 | 14.92 | | V |
| I_{SC} | Short Circuit Current | | | ± 120 | | mA |
| I_{OUT} | Output Current | | | ± 30 | | mA |
| POWER SUPPLY PERFORMANCE | | | | | | |
| PSRR | Power Supply Rejection Ratio | V_S is moved from 4.5V to 15.5V | 60 | 80 | | dB |
| I_S | Supply Current (Per Amplifier) | No load | | 500 | 750 | μA |
| DYNAMIC PERFORMANCE | | | | | | |
| SR | Slew Rate (Note 12) | $1V \leq V_{OUT} \leq 14V$, 20% to 80% | | 10 | | $V/\mu s$ |
| t_s | Settling to +0.1% ($A_V = +1$) | ($A_V = +1$), $V_O = 2V$ step | | 500 | | ns |
| BW | -3dB Bandwidth | $R_L = 10k\Omega$, $C_L = 10pF$ | | 12 | | MHz |
| GBWP | Gain-Bandwidth Product | $R_L = 10k\Omega$, $C_L = 10pF$ | | 8 | | MHz |
| PM | Phase Margin | $R_L = 10k\Omega$, $C_L = 10pF$ | | 50 | | $^\circ$ |
| CS | Channel Separation | $f = 5MHz$ (EL5220 and EL5420 only) | | 75 | | dB |

NOTES:

11. Measured over operating temperature range
12. Slew rate is measured on rising and falling edges

Typical Performance Curves



FIGURE 1. EL5420 INPUT OFFSET VOLTAGE DISTRIBUTION

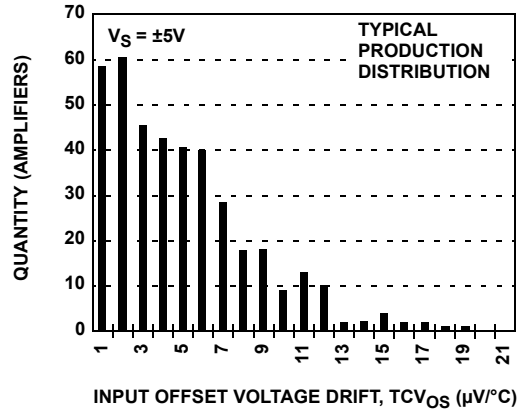

FIGURE 2. EL5420 INPUT OFFSET VOLTAGE DRIFT



FIGURE 3. INPUT OFFSET VOLTAGE vs TEMPERATURE



FIGURE 4. INPUT BIAS CURRENT vs TEMPERATURE



FIGURE 5. OUTPUT HIGH VOLTAGE vs TEMPERATURE



FIGURE 6. OUTPUT LOW VOLTAGE vs TEMPERATURE

Typical Performance Curves (Continued)



FIGURE 7. OPEN LOOP GAIN vs TEMPERATURE

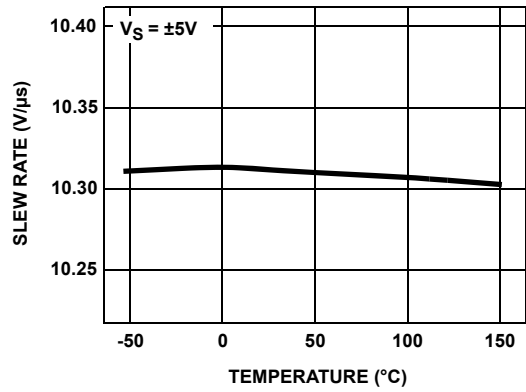

FIGURE 8. SLEW RATE vs TEMPERATURE

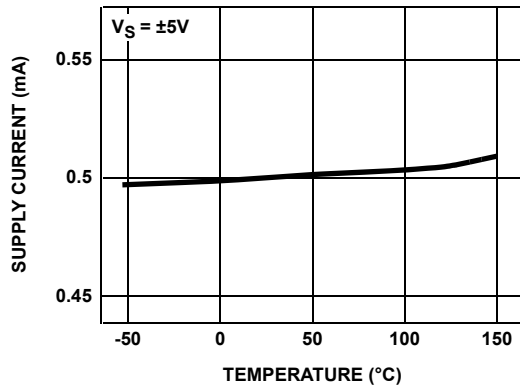

FIGURE 9. EL5420 SUPPLY CURRENT PER AMPLIFIER vs TEMPERATURE

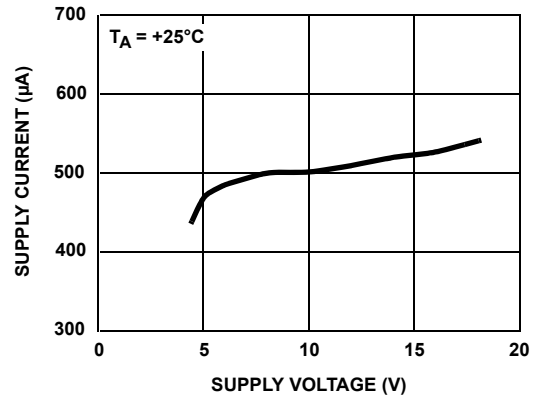

FIGURE 10. EL5420 SUPPLY CURRENT PER AMPLIFIER vs SUPPLY VOLTAGE



FIGURE 11. OPEN LOOP GAIN AND PHASE vs FREQUENCY

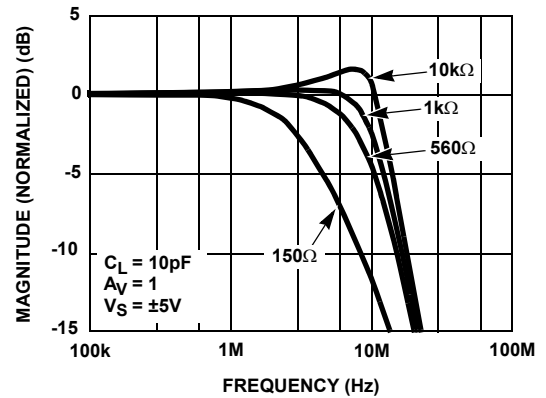

FIGURE 12. FREQUENCY RESPONSE FOR VARIOUS R_L

Typical Performance Curves (Continued)



FIGURE 13. FREQUENCY RESPONSE FOR VARIOUS C_L



FIGURE 14. CLOSED LOOP OUTPUT IMPEDANCE vs FREQUENCY



FIGURE 15. MAXIMUM OUTPUT SWING vs FREQUENCY



FIGURE 16. CMRR vs FREQUENCY

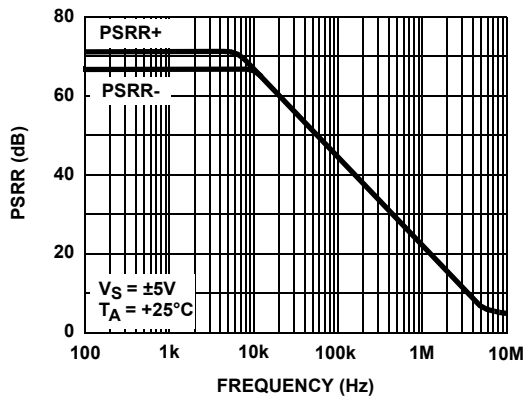

FIGURE 17. PSRR vs FREQUENCY

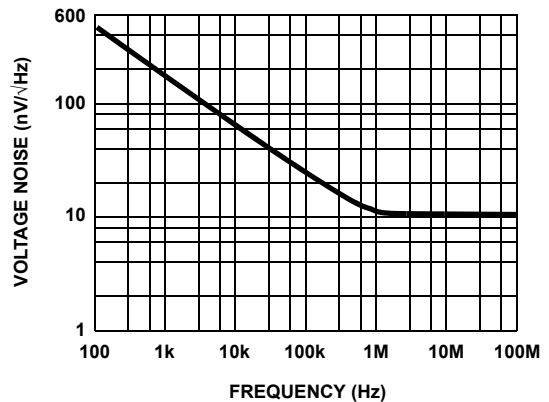

FIGURE 18. INPUT VOLTAGE NOISE SPECTRAL DENSITY vs FREQUENCY

Typical Performance Curves (Continued)



FIGURE 19. TOTAL HARMONIC DISTORTION + NOISE vs FREQUENCY



FIGURE 20. CHANNEL SEPARATION vs FREQUENCY RESPONSE



FIGURE 21. SMALL SIGNAL OVERSHOOT vs LOAD CAPACITANCE



FIGURE 22. SETTLING TIME vs STEP SIZE



FIGURE 23. LARGE SIGNAL TRANSIENT RESPONSE



FIGURE 24. SMALL SIGNAL TRANSIENT RESPONSE

Pin Descriptions

| EL5120 | EL5220 | EL5420 | | PIN NAME | PIN FUNCTION | EQUIVALENT CIRCUIT |
|-----------|------------------------|----------------------------|-----------|----------|---------------------------------|-----------------------|
| 5 LD TSOT | 8 LD MSOP, 8 LD DFN | 14 LD TSSOP, 14 LD SOIC | 16 LD QFN | | | |
| | | | 13, 16 | NC | No Connect | |
| | | | | IN+ | Amplifier Non-Inverting Input | (Reference Circuit 1) |
| | | | | IN- | Amplifier Inverting Input | (Reference Circuit 1) |
| | | | | OUT | Amplifier Output | (Reference Circuit 2) |
| 3 | | | | VIN+ | Amplifier Non-Inverting Input | (Reference Circuit 1) |
| 4 | | | | VIN- | Amplifier Inverting Input | (Reference Circuit 1) |
| 1 | | | | VOUT | Amplifier Output | (Reference Circuit 2) |
| | 1 | 1 | 15 | VOUTA | Amplifier A Output | (Reference Circuit 2) |
| | 2 | 2 | 1 | VINA- | Amplifier A Inverting Input | (Reference Circuit 1) |
| | 3 | 3 | 2 | VINA+ | Amplifier A Non-Inverting Input | (Reference Circuit 1) |
| 5 | 8 | 4 | 3 | VS+ | Positive Power Supply | |
| | 5 | 5 | 4 | VINB+ | Amplifier B Non-Inverting Input | (Reference Circuit 1) |
| | 6 | 6 | 5 | VINB- | Amplifier B Inverting Input | (Reference Circuit 1) |
| | 7 | 7 | 6 | VOUTB | Amplifier B Output | (Reference Circuit 2) |
| | | 8 | 7 | VOUTC | Amplifier C Output | (Reference Circuit 2) |
| | | 9 | 8 | VINC- | Amplifier C Inverting Input | (Reference Circuit 1) |
| | | 10 | 9 | VINC+ | Amplifier C Non-Inverting Input | (Reference Circuit 1) |
| 2 | 4 | 11 | 10 | VS- | Negative Power Supply | |
| | | 12 | 11 | VIND+ | Amplifier D Non-Inverting Input | (Reference Circuit 1) |
| | | 13 | 12 | VIND- | Amplifier D Inverting Input | (Reference Circuit 1) |
| | | 14 | 14 | VOUTD | Amplifier D Output | (Reference Circuit 2) |

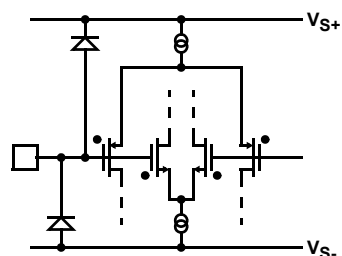

CIRCUIT 1

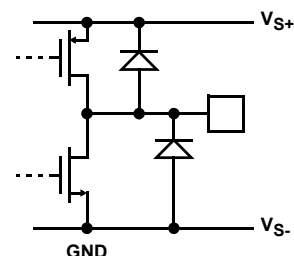

CIRCUIT 2

Applications Information

Product Description

The EL5120, EL5220, and EL5420 voltage feedback amplifiers are fabricated using a high voltage CMOS process. They exhibit rail-to-rail input and output capability, they are unity gain stable, and have low power consumption (500µA per amplifier). These features make the EL5120, EL5220, and EL5420 ideal for a wide range of general-purpose applications. Connected in voltage follower mode and driving a load of 10kΩ and 12pF, the EL5120, EL5220, and EL5420 have a -3dB bandwidth of 12MHz while maintaining a 10V/µs slew rate. The EL5120 is a single amplifier, the EL5220 is a dual amplifier, and the EL5420 is a quad amplifier.

Operating Voltage, Input, and Output

The EL5120, EL5220, and EL5420 are specified with a single nominal supply voltage from 5V to 15V or a split supply with its total range from 5V to 15V. Correct operation is guaranteed for a supply range of 4.5V to 16.5V. Most EL5120, EL5220, and EL5420 specifications are stable over both the full supply range and operating junction temperature range of -40°C to +125°C. Parameter variations with operating voltage and/or temperature are shown in the typical performance curves.

The input common-mode voltage range of the EL5120, EL5220, and EL5420 extends 500mV beyond the supply rails. The output swings of the EL5120, EL5220, and EL5420 typically extend to within 80mV of positive and negative supply rails with load currents of 5mA. Decreasing load currents will extend the output voltage range even closer to the supply rails. Figure 25 shows the input and output waveforms for the device in the unity-gain configuration. Operation is from ±5V supply with a 10kΩ load connected to GND. The input is a 10V_{P-P} sinusoid. The output voltage is approximately 9.985V_{P-P}.

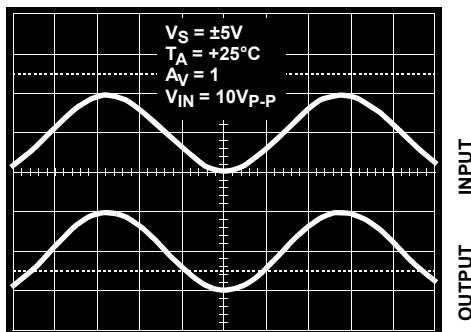

FIGURE 25. OPERATION WITH RAIL-TO-RAIL INPUT AND OUTPUT

Short Circuit Current Limit

The EL5120, EL5220, and EL5420 will limit the short circuit current to ±120mA if the output is directly shorted to the positive or the negative supply. If an output is shorted

indefinitely, the power dissipation could easily increase such that the device may be damaged. Maximum reliability is maintained if the output continuous current never exceeds ±30mA. This limit is set by the design of the internal metal interconnects.

Output Phase Reversal

The EL5120, EL5220, and EL5420 are immune to phase reversal as long as the input voltage is limited from (V_{S-}) -0.5V to (V_{S+}) +0.5V. Figure 26 shows a photo of the output of the device with the input voltage driven beyond the supply rails. Although the device's output will not change phase, the input's overvoltage should be avoided. If an input voltage exceeds supply voltage by more than 0.6V, electrostatic protection diodes placed in the input stage of the device begin to conduct and overvoltage damage could occur.



FIGURE 26. OPERATION WITH BEYOND-THE-RAILS INPUT

Power Dissipation

With the high-output drive capability of the EL5120, EL5220, and EL5420 amplifiers, it is possible to exceed the +125°C maximum operating junction temperature under certain load current conditions. Therefore, it is important to calculate the maximum junction temperature for the application to determine if load conditions need to be modified for the amplifier to remain in the safe operating area.

The maximum power dissipation allowed in a package is determined according to Equation 1:

$$P_{DMAX} = \frac{T_{JMAX} - T_{AMAX}}{\theta_{JA}} \quad (EQ. 1)$$

where:

- T_{JMAX} = Maximum junction temperature
- T_{AMAX} = Maximum ambient temperature
- θ_{JA} = Thermal resistance of the package
- P_{DMAX} = Maximum power dissipation in the package

The maximum power dissipation actually produced by an IC is the total quiescent supply current times the total power

supply voltage, plus the power in the IC due to the loads as shown in Equation 2:

$$P_{D_{MAX}} = \sum i \times [V_S \times I_{S_{MAX}} + (V_{S^+} - V_{OUT^i}) \times I_{LOAD^i}] \quad (EQ. 2)$$

when sourcing, and:

$$P_{D_{MAX}} = \sum i \times [V_S \times I_{S_{MAX}} + (V_{OUT^i} - V_{S^-}) \times I_{LOAD^i}] \quad (EQ. 3)$$

when sinking.

where:

- $i = 1$ to 2 for dual and 1 to 4 for quad
- V_S = Total supply voltage
- $I_{S_{MAX}}$ = Maximum supply current per amplifier
- V_{OUT^i} = Maximum output voltage of the application
- I_{LOAD^i} = Load current

If we set the two $P_{D_{MAX}}$ equations equal to each other, we can solve for R_{LOAD^i} to avoid device overheat. Figure 27 provide a convenient way to see if the device will overheat. The maximum safe power dissipation can be found graphically, based on the package type and the ambient temperature. By using the previous equation, it is a simple matter to see if $P_{D_{MAX}}$ exceeds the device's power derating curves. To ensure proper operation, it is important to observe the recommended derating curves in Figure 27.



FIGURE 27. PACKAGE POWER DISSIPATION vs AMBIENT TEMPERATURE

Unused Amplifiers

It is recommended that any unused amplifiers in a dual and a quad package be configured as a unity gain follower. The inverting input should be directly connected to the output and the non-inverting input tied to the ground plane.

Driving Capacitive Loads

The EL5120, EL5220, and EL5420 can drive a wide range of capacitive loads. As load capacitance increases, however, the -3dB bandwidth of the device will decrease and the peaking will increase. The amplifiers drive 10pF loads in parallel with

10kΩ with just 1.5dB of peaking, and 100pF with 6.4dB of peaking. If less peaking is desired in these applications, a small series resistor (usually between 5Ω and 50Ω) can be placed in series with the output. However, this will obviously reduce the gain slightly. Another method of reducing peaking is to add a “snubber” circuit at the output. A snubber is a shunt load consisting of a resistor in series with a capacitor. Values of 150Ω and 10nF are typical. The advantage of a snubber is that it does not draw any DC load current or reduce the gain

Power Supply Bypassing and Printed Circuit Board Layout

The EL5120, EL5220, and EL5420 can provide gain at high frequency. As with any high-frequency device, good printed circuit board layout is necessary for optimum performance. Ground plane construction is highly recommended, lead lengths should be as short as possible and the power supply pins must be well bypassed to reduce the risk of oscillation. For normal single supply operation, where the VS- pin is connected to ground, a 0.1μF ceramic capacitor should be placed from VS+ to pin to VS- pin. A 4.7μF tantalum capacitor should then be connected in parallel, placed in the region of the amplifier. One 4.7μF capacitor may be used for multiple devices. This same capacitor combination should be placed at each supply pin to ground if split supplies are to be used.

Revision History

The revision history provided is for informational purposes only and is believed to be accurate, but not warranted. Please go to the web to make sure that you have the latest revision.

| DATE | REVISION | CHANGE |
|------------------|----------|--|
| October 15, 2015 | FN7186.8 | - Updated Ordering Information Table on page 2. - Added Revision History. - Added About Intersil Verbiage. |

About Intersil

Intersil Corporation is a leading provider of innovative power management and precision analog solutions. The company's products address some of the largest markets within the industrial and infrastructure, mobile computing and high-end consumer markets.

For the most updated datasheet, application notes, related documentation and related parts, please see the respective product information page found at www.intersil.com.

You may report errors or suggestions for improving this datasheet by visiting www.intersil.com/ask.

Reliability reports are also available from our website at www.intersil.com/support.

© Copyright Intersil Americas LLC 2004-2015. All Rights Reserved.
All trademarks and registered trademarks are the property of their respective owners.

For additional products, see www.intersil.com/en/products.html

Intersil products are manufactured, assembled and tested utilizing ISO9001 quality systems as noted in the quality certifications found at www.intersil.com/en/support/qualandreliability.html

Intersil products are sold by description only. Intersil may modify the circuit design and/or specifications of products at any time without notice, provided that such modification does not, in Intersil's sole judgment, affect the form, fit or function of the product. Accordingly, the reader is cautioned to verify that datasheets are current before placing orders. Information furnished by Intersil is believed to be accurate and reliable. However, no responsibility is assumed by Intersil or its subsidiaries for its use; nor for any infringements of patents or other rights of third parties which may result from its use. No license is granted by implication or otherwise under any patent or patent rights of Intersil or its subsidiaries.

For information regarding Intersil Corporation and its products, see www.intersil.com

Package Outline Drawing

L8.2x3

8 LEAD DUAL FLAT NO-LEAD PLASTIC PACKAGE

Rev 1, 3/10

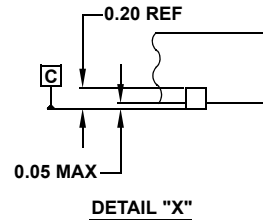
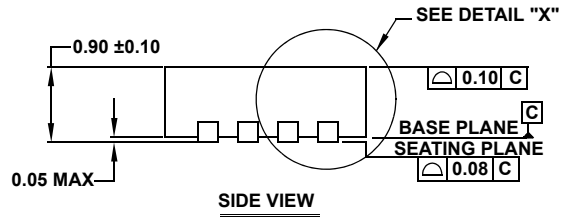
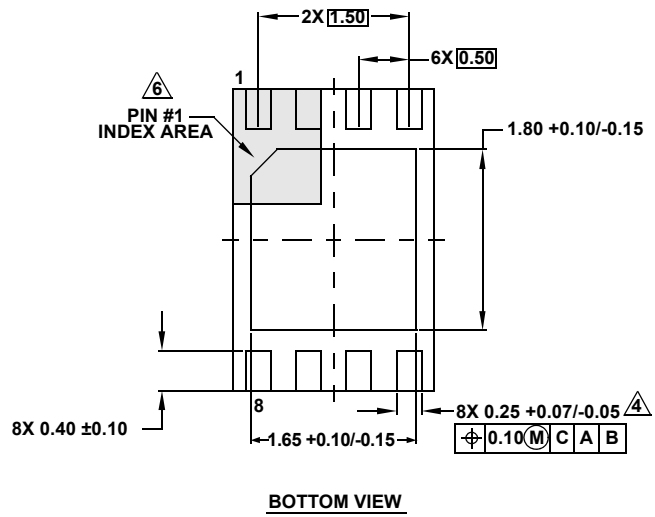

NOTES:

1. Dimensions are in millimeters.
Dimensions in () for Reference Only.
2. Dimensioning and tolerancing conform to ASME Y14.5m-1994.
3. Unless otherwise specified, tolerance : Decimal ± 0.05
4. Dimension applies to the metallized terminal and is measured between 0.25mm and 0.30mm from the terminal tip.
5. Tiebar shown (if present) is a non-functional feature.
6. The configuration of the pin #1 identifier is optional, but must be located within the zone indicated. The pin #1 identifier may be either a mold or mark feature.
7. Complies to JEDEC MO-229 VCED-2.

Small Outline Package Family (SO)

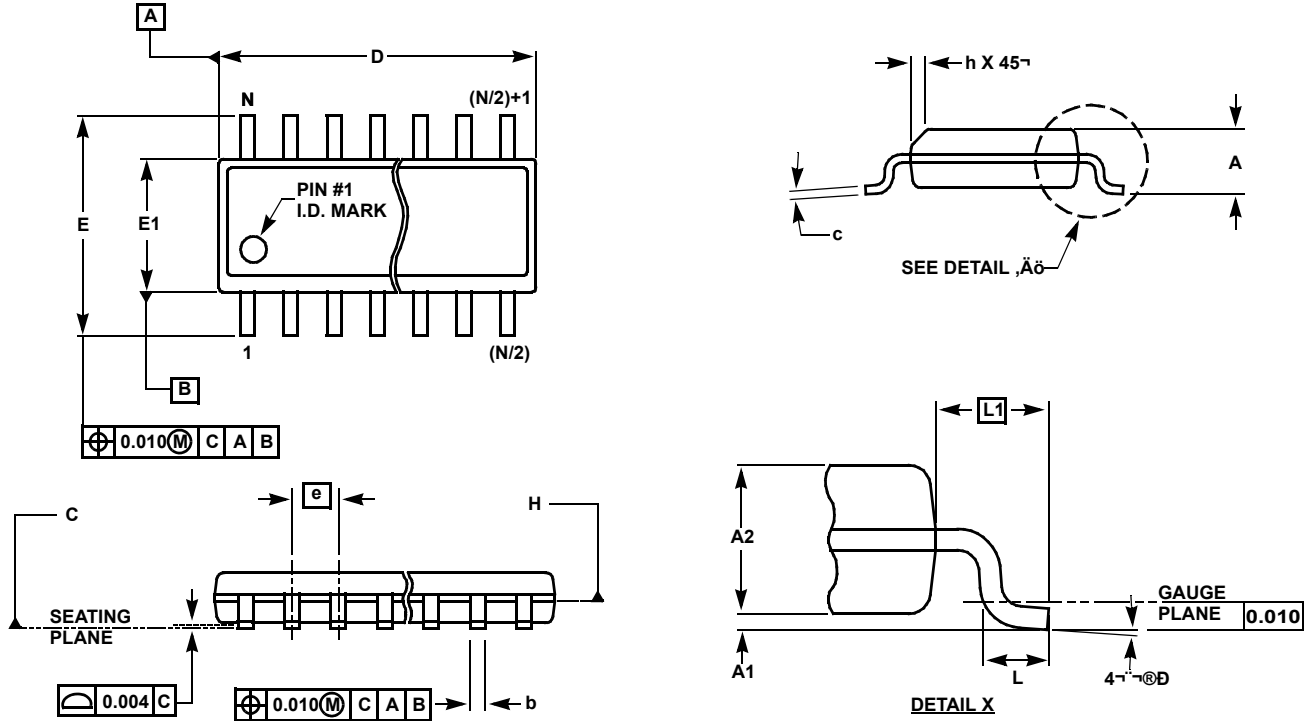

MDP0027

SMALL OUTLINE PACKAGE FAMILY (SO)

| SYMBOL | INCHES | | | | | | | TOLERANCE | NOTES |
|--------|--------|-------|---------------|------------------------|---------------|---------------|---------------|-----------|-------|
| | SO-8 | SO-14 | SO16 (0.150") | SO16 (0.300") (SOL-16) | SO20 (SOL-20) | SO24 (SOL-24) | SO28 (SOL-28) | | |
| A | 0.068 | 0.068 | 0.068 | 0.104 | 0.104 | 0.104 | 0.104 | MAX | - |
| A1 | 0.006 | 0.006 | 0.006 | 0.007 | 0.007 | 0.007 | 0.007 | ±0.003 | - |
| A2 | 0.057 | 0.057 | 0.057 | 0.092 | 0.092 | 0.092 | 0.092 | ±0.002 | - |
| b | 0.017 | 0.017 | 0.017 | 0.017 | 0.017 | 0.017 | 0.017 | ±0.003 | - |
| c | 0.009 | 0.009 | 0.009 | 0.011 | 0.011 | 0.011 | 0.011 | ±0.001 | - |
| D | 0.193 | 0.341 | 0.390 | 0.406 | 0.504 | 0.606 | 0.704 | ±0.004 | 1, 3 |
| E | 0.236 | 0.236 | 0.236 | 0.406 | 0.406 | 0.406 | 0.406 | ±0.008 | - |
| E1 | 0.154 | 0.154 | 0.154 | 0.295 | 0.295 | 0.295 | 0.295 | ±0.004 | 2, 3 |
| e | 0.050 | 0.050 | 0.050 | 0.050 | 0.050 | 0.050 | 0.050 | Basic | - |
| L | 0.025 | 0.025 | 0.025 | 0.030 | 0.030 | 0.030 | 0.030 | ±0.009 | - |
| L1 | 0.041 | 0.041 | 0.041 | 0.056 | 0.056 | 0.056 | 0.056 | Basic | - |
| h | 0.013 | 0.013 | 0.013 | 0.020 | 0.020 | 0.020 | 0.020 | Reference | - |
| N | 8 | 14 | 16 | 16 | 20 | 24 | 28 | Reference | - |

Rev. M 2/07

NOTES:

1. Plastic or metal protrusions of 0.006" maximum per side are not included.
2. Plastic interlead protrusions of 0.010" maximum per side are not included.
3. Dimensions "D" and "E1" are measured at Datum Plane "H".
4. Dimensioning and tolerancing per ASME Y14.5M-1994

Mini SO Package Family (MSOP)

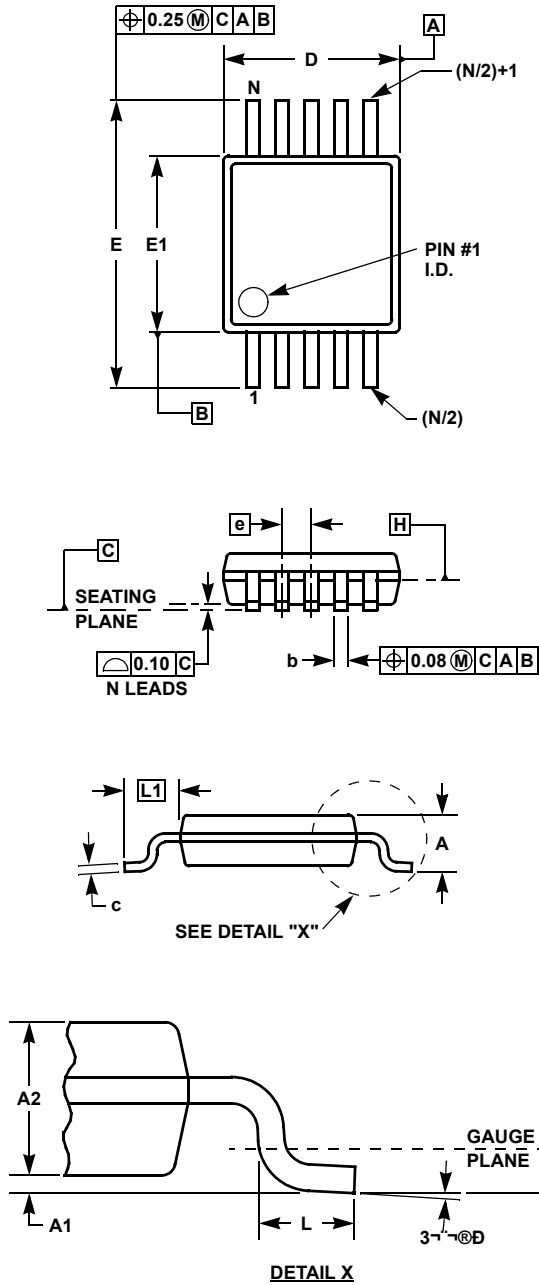

MDP0043 MINI SO PACKAGE FAMILY

| SYMBOL | MILLIMETERS | | TOLERANCE | NOTES |
|--------|-------------|--------|-------------|-------|
| | MSOP8 | MSOP10 | | |
| A | 1.10 | 1.10 | Max. | - |
| A1 | 0.10 | 0.10 | ±0.05 | - |
| A2 | 0.86 | 0.86 | ±0.09 | - |
| b | 0.33 | 0.23 | +0.07/-0.08 | - |
| c | 0.18 | 0.18 | ±0.05 | - |
| D | 3.00 | 3.00 | ±0.10 | 1, 3 |
| E | 4.90 | 4.90 | ±0.15 | - |
| E1 | 3.00 | 3.00 | ±0.10 | 2, 3 |
| e | 0.65 | 0.50 | Basic | - |
| L | 0.55 | 0.55 | ±0.15 | - |
| L1 | 0.95 | 0.95 | Basic | - |
| N | 8 | 10 | Reference | - |

Rev. D 2/07

NOTES:

1. Plastic or metal protrusions of 0.15mm maximum per side are not included.
2. Plastic interlead protrusions of 0.25mm maximum per side are not included.
3. Dimensions "D" and "E1" are measured at Datum Plane "H".
4. Dimensioning and tolerancing per ASME Y14.5M-1994.

Thin Shrink Small Outline Package Family (TSSOP)

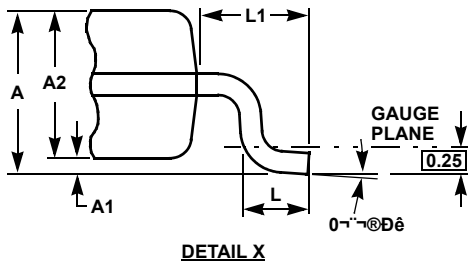
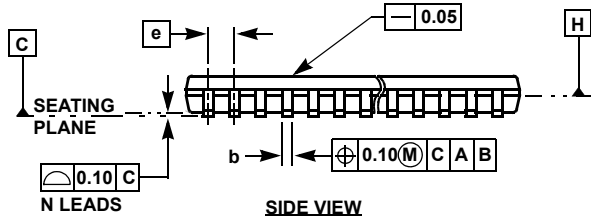

MDP0044

THIN SHRINK SMALL OUTLINE PACKAGE FAMILY

| SYMBOL | MILLIMETERS | | | | | TOLERANCE |
|--------|-------------|-------|-------|-------|-------|-------------|
| | 14 LD | 16 LD | 20 LD | 24 LD | 28 LD | |
| A | 1.20 | 1.20 | 1.20 | 1.20 | 1.20 | Max |
| A1 | 0.10 | 0.10 | 0.10 | 0.10 | 0.10 | ±0.05 |
| A2 | 0.90 | 0.90 | 0.90 | 0.90 | 0.90 | ±0.05 |
| b | 0.25 | 0.25 | 0.25 | 0.25 | 0.25 | +0.05/-0.06 |
| c | 0.15 | 0.15 | 0.15 | 0.15 | 0.15 | +0.05/-0.06 |
| D | 5.00 | 5.00 | 6.50 | 7.80 | 9.70 | ±0.10 |
| E | 6.40 | 6.40 | 6.40 | 6.40 | 6.40 | Basic |
| E1 | 4.40 | 4.40 | 4.40 | 4.40 | 4.40 | ±0.10 |
| e | 0.65 | 0.65 | 0.65 | 0.65 | 0.65 | Basic |
| L | 0.60 | 0.60 | 0.60 | 0.60 | 0.60 | ±0.15 |
| L1 | 1.00 | 1.00 | 1.00 | 1.00 | 1.00 | Reference |

Rev. F 2/07

NOTES:

1. Dimension "D" does not include mold flash, protrusions or gate burrs. Mold flash, protrusions or gate burrs shall not exceed 0.15mm per side.
2. Dimension "E1" does not include interlead flash or protrusions. Interlead flash and protrusions shall not exceed 0.25mm per side.
3. Dimensions "D" and "E1" are measured at dAtum Plane H.
4. Dimensioning and tolerancing per ASME Y14.5M-1994.

QFN (Quad Flat No-Lead) Package Family

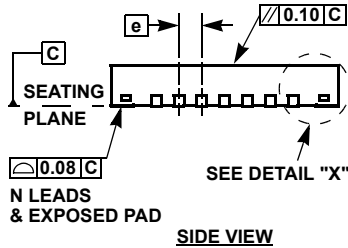

MDP0046

**QFN (QUAD FLAT NO-LEAD) PACKAGE FAMILY
(COMPLIANT TO JEDEC MO-220)**

| SYMBOL | MILLIMETERS | | | | TOLERANCE | NOTES |
|--------|-------------|------|-------|-----------|-------------|-------|
| | QFN44 | QFN3 | QFN32 | | | |
| A | 0.90 | 0.90 | 0.90 | 0.90 | ±0.10 | - |
| A1 | 0.02 | 0.02 | 0.02 | 0.02 | +0.03/-0.02 | - |
| b | 0.25 | 0.25 | 0.23 | 0.22 | ±0.02 | - |
| c | 0.20 | 0.20 | 0.20 | 0.20 | Reference | - |
| D | 7.00 | 5.00 | 8.00 | 5.00 | Basic | - |
| D2 | 5.10 | 3.80 | 5.80 | 3.60/2.48 | Reference | 8 |
| E | 7.00 | 7.00 | 8.00 | 6.00 | Basic | - |
| E2 | 5.10 | 5.80 | 5.80 | 4.60/3.40 | Reference | 8 |
| e | 0.50 | 0.50 | 0.80 | 0.50 | Basic | - |
| L | 0.55 | 0.40 | 0.53 | 0.50 | ±0.05 | - |
| N | 44 | 38 | 32 | 32 | Reference | 4 |
| ND | 11 | 7 | 8 | 7 | Reference | 6 |
| NE | 11 | 12 | 8 | 9 | Reference | 5 |

| SYMBOL | MILLIMETERS | | | | | TOLERANCE | NOTES |
|--------|-------------|------|-------|------|-------|-------------|-------|
| | QFN28 | QFN2 | QFN20 | | QFN16 | | |
| A | 0.90 | 0.90 | 0.90 | 0.90 | 0.90 | ±0.10 | - |
| A1 | 0.02 | 0.02 | 0.02 | 0.02 | 0.02 | +0.03/-0.02 | - |
| b | 0.25 | 0.25 | 0.30 | 0.25 | 0.33 | ±0.02 | - |
| c | 0.20 | 0.20 | 0.20 | 0.20 | 0.20 | Reference | - |
| D | 4.00 | 4.00 | 5.00 | 4.00 | 4.00 | Basic | - |
| D2 | 2.65 | 2.80 | 3.70 | 2.70 | 2.40 | Reference | - |
| E | 5.00 | 5.00 | 5.00 | 4.00 | 4.00 | Basic | - |
| E2 | 3.65 | 3.80 | 3.70 | 2.70 | 2.40 | Reference | - |
| e | 0.50 | 0.50 | 0.65 | 0.50 | 0.65 | Basic | - |
| L | 0.40 | 0.40 | 0.40 | 0.40 | 0.60 | ±0.05 | - |
| N | 28 | 24 | 20 | 20 | 16 | Reference | 4 |
| ND | 6 | 5 | 5 | 5 | 4 | Reference | 6 |
| NE | 8 | 7 | 5 | 5 | 4 | Reference | 5 |

Rev 11 2/07

NOTES:

1. Dimensioning and tolerancing per ASME Y14.5M-1994.
2. Tiebar view shown is a non-functional feature.
3. Bottom-side pin #1 I.D. is a diepad chamfer as shown.
4. N is the total number of terminals on the device.
5. NE is the number of terminals on the "E" side of the package (or Y-direction).
6. ND is the number of terminals on the "D" side of the package (or X-direction). ND = (N/2)-NE.
7. Inward end of terminal may be square or circular in shape with radius (b/2) as shown.
8. If two values are listed, multiple exposed pad options are available. Refer to device-specific datasheet.

TSOT Package Family

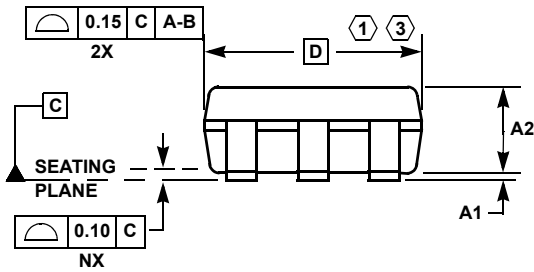
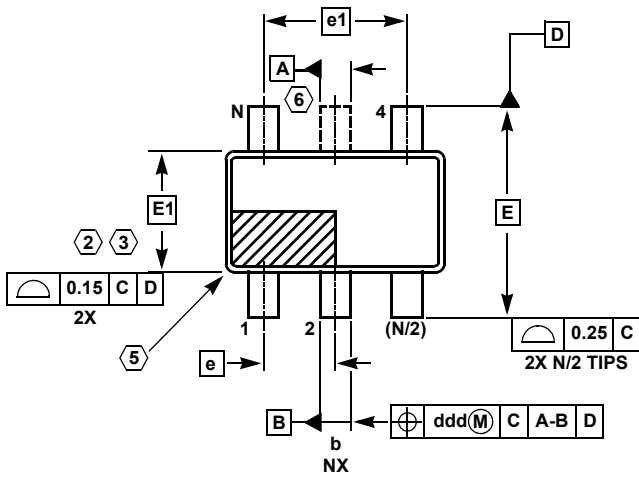

MDP0049

TSOT PACKAGE FAMILY

| SYMBOL | MILLIMETERS | | | TOLERANCE |
|--------|-------------|-------|-------|--------------|
| | TSOT5 | TSOT6 | TSOT8 | |
| A | 1.00 | 1.00 | 1.00 | Max |
| A1 | 0.05 | 0.05 | 0.05 | ±0.05 |
| A2 | 0.87 | 0.87 | 0.87 | ±0.03 |
| b | 0.38 | 0.38 | 0.29 | ±0.07 |
| c | 0.127 | 0.127 | 0.127 | +0.07/-0.007 |
| D | 2.90 | 2.90 | 2.90 | Basic |
| E | 2.80 | 2.80 | 2.80 | Basic |
| E1 | 1.60 | 1.60 | 1.60 | Basic |
| e | 0.95 | 0.95 | 0.65 | Basic |
| e1 | 1.90 | 1.90 | 1.95 | Basic |
| L | 0.40 | 0.40 | 0.40 | ±0.10 |
| L1 | 0.60 | 0.60 | 0.60 | Reference |
| ddd | 0.20 | 0.20 | 0.13 | - |
| N | 5 | 6 | 8 | Reference |

Rev. B 2/07

NOTES:

1. Plastic or metal protrusions of 0.15mm maximum per side are not included.
2. Plastic interlead protrusions of 0.15mm maximum per side are not included.
3. This dimension is measured at Datum Plane "H".
4. Dimensioning and tolerancing per ASME Y14.5M-1994.
5. Index area - Pin #1 I.D. will be located within the indicated zone (TSOT6 AND TSOT8 only).
6. TSOT5 version has no center lead (shown as a dashed line).

Package Outline Drawing

M14.173

14 LEAD THIN SHRINK SMALL OUTLINE PACKAGE (TSSOP)

Rev 3, 10/09

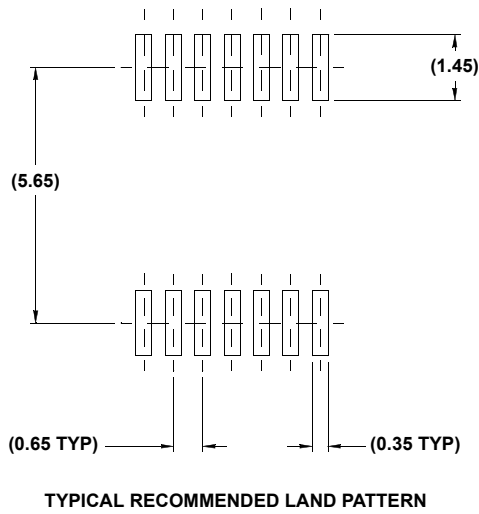
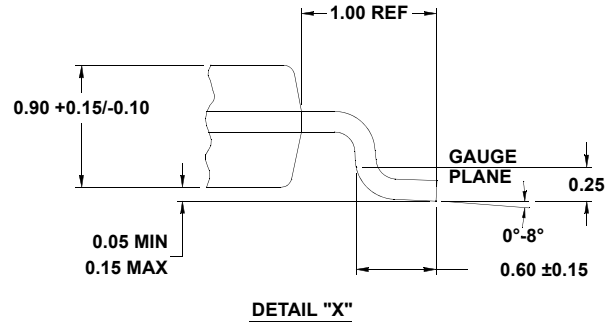
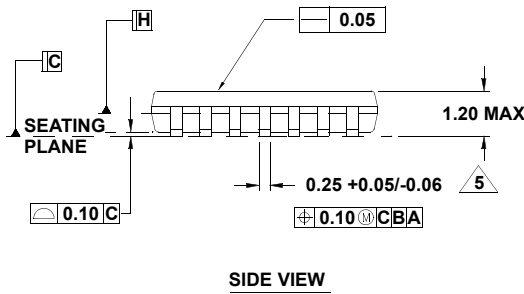
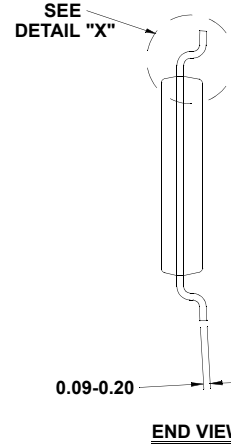
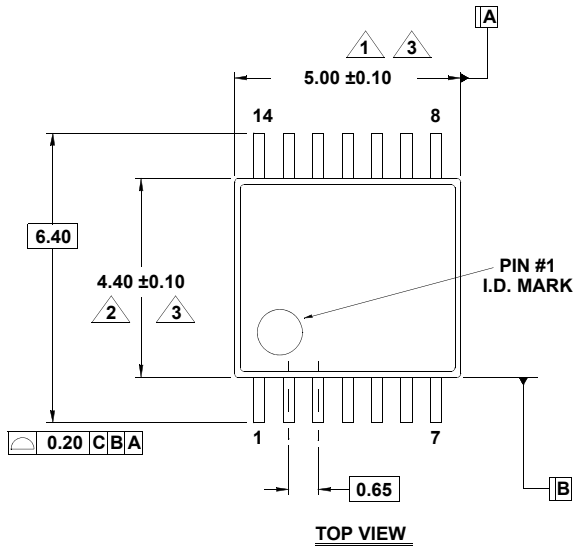

NOTES:

1. Dimension does not include mold flash, protrusions or gate burrs. Mold flash, protrusions or gate burrs shall not exceed 0.15 per side.
2. Dimension does not include interlead flash or protrusion. Interlead flash or protrusion shall not exceed 0.25 per side.
3. Dimensions are measured at datum plane H.
4. Dimensioning and tolerancing per ASME Y14.5M-1994.
5. Dimension does not include dambar protrusion. Allowable protrusion shall be 0.80mm total in excess of dimension at maximum material condition. Minimum space between protrusion and adjacent lead is 0.07mm.
6. Dimension in () are for reference only.
7. Conforms to JEDEC MO-153, variation AB-1.

Компания «Океан Электроники» предлагает заключение долгосрочных отношений при поставках импортных электронных компонентов на взаимовыгодных условиях!

Наши преимущества:

- Поставка оригинальных импортных электронных компонентов напрямую с производств Америки, Европы и Азии, а так же с крупнейших складов мира;
- Широкая линейка поставок активных и пассивных импортных электронных компонентов (более 30 млн. наименований);
- Поставка сложных, дефицитных, либо снятых с производства позиций;
- Оперативные сроки поставки под заказ (от 5 рабочих дней);
- Экспресс доставка в любую точку России;
- Помощь Конструкторского Отдела и консультации квалифицированных инженеров;
- Техническая поддержка проекта, помощь в подборе аналогов, поставка прототипов;
- Поставка электронных компонентов под контролем ВП;
- Система менеджмента качества сертифицирована по Международному стандарту ISO 9001;
- При необходимости вся продукция военного и аэрокосмического назначения проходит испытания и сертификацию в лаборатории (по согласованию с заказчиком);
- Поставка специализированных компонентов военного и аэрокосмического уровня качества (Xilinx, Altera, Analog Devices, Intersil, Interpoint, Microsemi, Actel, Aeroflex, Peregrine, VPT, Syfer, Eurofarad, Texas Instruments, MS Kennedy, Miteq, Cobham, E2V, MA-COM, Hittite, Mini-Circuits, General Dynamics и др.);

Компания «Океан Электроники» является официальным дистрибьютором и эксклюзивным представителем в России одного из крупнейших производителей разъемов военного и аэрокосмического назначения «**JONHON**», а так же официальным дистрибьютором и эксклюзивным представителем в России производителя высокотехнологичных и надежных решений для передачи СВЧ сигналов «**FORSTAR**».



JONHON

«**JONHON**» (основан в 1970 г.)

Разъемы специального, военного и аэрокосмического назначения:

(Применяются в военной, авиационной, аэрокосмической, морской, железнодорожной, горно- и нефтедобывающей отраслях промышленности)

«**FORSTAR**» (основан в 1998 г.)

ВЧ соединители, коаксиальные кабели,
кабельные сборки и микроволновые компоненты:

(Применяются в телекоммуникациях гражданского и специального назначения, в средствах связи, РЛС, а так же военной, авиационной и аэрокосмической отраслях промышленности).



Телефон: 8 (812) 309-75-97 (многоканальный)

Факс: 8 (812) 320-03-32

Электронная почта: ocean@oceanchips.ru

Web: <http://oceanchips.ru/>

Адрес: 198099, г. Санкт-Петербург, ул. Калинина, д. 2, корп. 4, лит. А