

Wireless Differential Pressure Sensors

General Description

The ALTA wireless differential pressure sensor measures the pressure difference between two input ports and transmits the measurement to iMonnit.

- Measurement range: -500 Pa to 500 Pa
- Calibrated and temperature compensated

Principle of Operation

The differential pressure sensor measures the pressure difference between two ports. When viewing the sensor from the top, the right inlet port is the positive or high side pressure input. When the pressure on this port is greater than the left port the sensor produces a negative pressure reading. When the pressure is greater on the left port the sensor produces a positive pressure reading.

Example Applications

- Building/Room Pressure
- Air Flow
- Variable Air Volume Filter Status
- Duct Pressure
- Clean Rooms
- Hospitals
- Fume Hoods
- Computer Rooms
- Many additional applications

Features of Monnit ALTA Sensors

- Wireless range of 1,200+ feet through 12+ walls *
- Frequency-Hopping Spread Spectrum (FHSS)
- Improved interference immunity
- Improved power management for longer battery life ** (~8+ years on AA batteries)
- Encrypt-RF® Security (Diffie-Hellman Key Exchange + AES-128 CBC for sensor data messages)
- All ALTA sensors now have up to 3200 readings:
 - 10-minute heartbeats = 22 days
 - 2-hour heartbeats = 266 days
- Over-the-air updates (future proof)
- Free iMonnit basic online wireless sensor monitoring and notification system to configure sensors, view data and set alerts via SMS text and email

- * Actual range may vary depending on environment.
 ** Battery life is determined by sensor reporting frequency and other variables. Other power options are also available.

Wireless Range Comparison

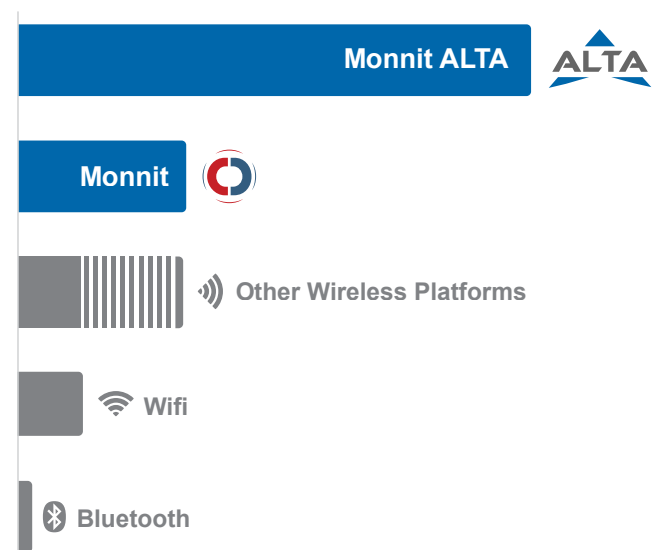

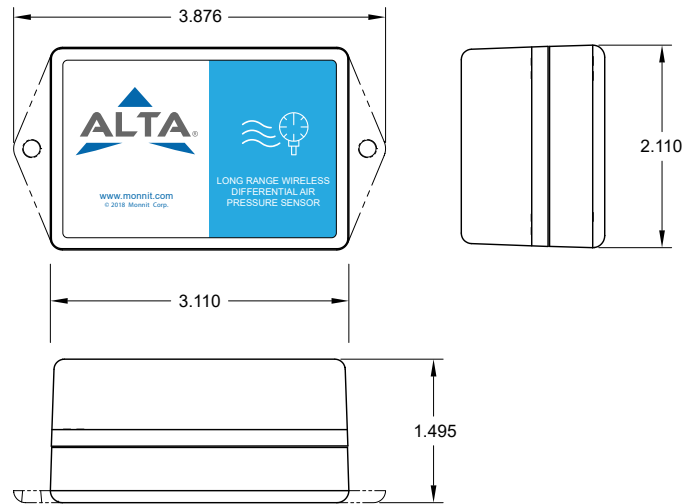

ALTA Differential Pressure Sensor | Technical Specifications

Supply voltage	2.7–3.8 VDC (3.0–3.8 VDC using power supply) *
Current consumption	0.2 μ A (sleep mode), 0.7 μ A (RTC sleep), 570 μ A (MCU idle), 2.5 mA (MCU active), 5.5 mA (radio RX mode), 22.6 mA (radio TX mode)
Operating temperature range (commercial version) **	-18°C to 55°C (0°F to 130°F) with Alkaline Batteries -40°C to 85°C (-40°F to 185°F) with Lithium Battery
Power	Line Power with Battery Backup & Switch
Pressure range	-500 Pa to 500 Pa
Allowable overpressure	100 kPa
Rated burst pressure	500 kPa
Max humidity for long-term exposure	40°C dew point
Accuracy	3% of reading +/- 0.1 Pa
Span repeatability	0.5% of reading
Span shift due to temperature variation	< 0.5% of reading per 10°C
Offset stability	< 0.05 Pa/year
Calibrated for	Air, N2
Media compatibility	Air, N2, O2, non-condensing
Temperature measurement range	-40°C to 85°C (-40°F to +185°F)
Calibrated temperature measurement range	-20°C to 85°C (-4°F to +185°F)
Temperature resolution	0.1°C
Temperature accuracy	+/- 2°C (-10°C to +60°C) +/- 3°C (-40°C to +85°C)
Temperature repeatability	+/- 0.1°C
Integrated memory	Up to 3200 sensor messages
Wireless range	1,200+ ft non-line-of-sight
Wireless operation	900 MHz—Frequency-Hopping Spread Spectrum 868 MHz and 433 MHz—Frequency-Agile Wireless
Security	Encrypt-RF® (256-bit key exchange and AES-128 CTR)
Weight	3.7 ounces
Certifications	900 MHz product; FCC ID: ZTL-G2SC1 and IC: 9794A-G2SC1. 868 and 433 MHz product tested and found to comply with: EN 300 220-2 V3.1.1 (2017-02), EN 300 220-2 V3.1.1 (2017-02) and EN 60950





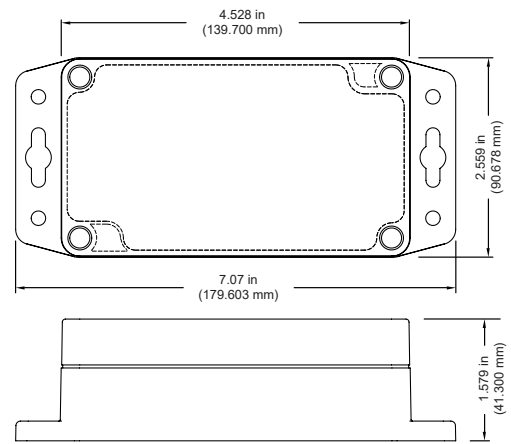

* Hardware cannot withstand negative voltage. Please take care when connecting a power device.

** At temperatures above 100°C, it is possible for the board circuitry to lose programmed memory.



ALTA Industrial Wireless Differential Pressure Sensor | Technical Specifications

Supply voltage	2.7–3.8 VDC (3.0–3.8 VDC using power supply) *	
Current consumption	0.2 μ A (sleep mode), 0.7 μ A (RTC sleep), 570 μ A (MCU idle), 2.5 mA (MCU active), 5.5 mA (radio RX mode), 22.6 mA (radio TX mode)	
Operating temperature range (board circuitry and battery)	-40°C to +85°C (-40°F to +185°F) **	
Included battery	Max temperature range	-40° to +85°C (-40° to +185°F)
	Capacity	1500 mAh
Optional solar feature	Solar panel	5VDC/30mA (53mm x 30mm)
	Charging temperature range	0° to 45°C (32° to 113°F)
	Max temperature range	-20° to 60°C (-4° to 140°F)
	Included rechargeable battery	600 mAh/>2000 charge cycles (80% of initial capacity)
	Solar efficiency	Optimized for high and low-light operation ***
Pressure range	-500 Pa to 500 Pa	
Allowable overpressure	100 kPa	
Rated burst pressure	500 kPa	
Max humidity for long-term exposure	40°C dew point	
Accuracy	3% of reading +/- 0.1 Pa	
Span repeatability	0.5% of reading	
Span shift due to temperature variation	< 0.5% of reading per 10°C	
Offset stability	< 0.05 Pa/year	
Calibrated for	Air, N2	
Media compatibility	Air, N2, O2, non-condensing	
Temperature measurement range	-40°C to 85°C (-40°F to +185°F)	
Calibrated temperature measurement range	0.1°C	
Temperature resolution	0.1°C	
Temperature accuracy	+/- 2°C (-10°C to +60°C) +/- 3°C (-40°C to +85°C)	
Temperature repeatability	+/- 0.1°C	
Integrated memory	Up to 3200 sensor messages	
Wireless range	1,200+ ft non-line-of-sight	
Security	Encrypt-RF® (256-bit key exchange and AES-128 CTR)	
Weight	4.7 ounces	
Enclosure rating	NEMA 1, 2, 4, 4x, 12 and 13 rated, sealed and weather proof	
UL rating	UL Listed to UL508-4x specifications (File E194432)	
Certifications	   	900 MHz product; FCC ID: ZTL-G2SC1 and IC: 9794A-G2SC1. 868 and 433 MHz product tested and found to comply with: EN 300 220-2 V3.1.1 (2017-02), EN 300 220-2 V3.1.1 (2017-02) and EN 60950

* Hardware cannot withstand negative voltage. Please take care when connecting a power device.

** At temperatures above 100°C, it is possible for the board circuitry to lose programmed memory.

Note

Do not connect any tubing to the pressure ports without the sensor lid securely installed. The lid helps keep the sensor in place and stabilizes and supports the pressure ports.

Pressurizing the positive side will produce a positive reading. Pressurizing the negative side will produce a negative reading.

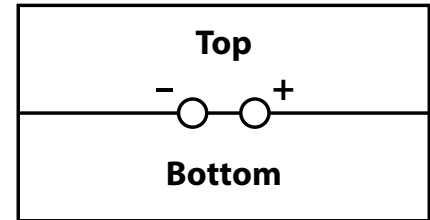

Commercial Grade Sensors

Monnit commercial grade sensors are designed for applications in ordinary environments (normal room temperature, humidity and atmospheric pressure). Do not use these sensors under the following conditions as these factors can deteriorate the product characteristics and cause failures and burn-out.

- Corrosive gas or deoxidizing gas: chlorine gas, hydrogen sulfide gas, ammonia gas, sulfuric acid gas, nitric oxides gas, etc.
- Volatile or flammable gas
- Dusty conditions
- Low-pressure or high-pressure environments
- Wet or excessively humid locations
- Places with salt water, oils chemical liquids or organic solvents
- Where there are excessively strong vibrations
- Other places where similar hazardous conditions exist

Use these products within the specified temperature range. Higher temperature may cause deterioration of the characteristics or the material quality.

Industrial Grade Sensors | Type 1, 2, 4, 4X, 12 and 13 NEMA Rated Enclosure

Monnit's Industrial sensors are enclosed in reliable, weatherproof NEMA-rated enclosures. Our NEMA-rated enclosures are constructed for both indoor or outdoor use and protect the sensor circuitry against the ingress of solid foreign objects like dust as well as the damaging effects of water (rain, sleet, snow, splashing water, and hose-directed water).

- Safe from falling dirt
- Protects against wind-blown dust
- Protects against rain, sleet, snow, splashing water, and hose-directed water
- Increased level of corrosion resistance
- Will remain undamaged by ice formation on the enclosure

MONNIT[®]

For more information about our products or to place an order, please contact our sales department at 801-561-5555.

Visit us on the web at www.monnit.com.

Monnit Corporation
3400 South West Temple
Salt Lake City, UT 84115
801-561-5555
www.monnit.com

Компания «Океан Электроники» предлагает заключение долгосрочных отношений при поставках импортных электронных компонентов на взаимовыгодных условиях!

Наши преимущества:

- Поставка оригинальных импортных электронных компонентов напрямую с производств Америки, Европы и Азии, а так же с крупнейших складов мира;
- Широкая линейка поставок активных и пассивных импортных электронных компонентов (более 30 млн. наименований);
- Поставка сложных, дефицитных, либо снятых с производства позиций;
- Оперативные сроки поставки под заказ (от 5 рабочих дней);
- Экспресс доставка в любую точку России;
- Помощь Конструкторского Отдела и консультации квалифицированных инженеров;
- Техническая поддержка проекта, помощь в подборе аналогов, поставка прототипов;
- Поставка электронных компонентов под контролем ВП;
- Система менеджмента качества сертифицирована по Международному стандарту ISO 9001;
- При необходимости вся продукция военного и аэрокосмического назначения проходит испытания и сертификацию в лаборатории (по согласованию с заказчиком);
- Поставка специализированных компонентов военного и аэрокосмического уровня качества (Xilinx, Altera, Analog Devices, Intersil, Interpoint, Microsemi, Actel, Aeroflex, Peregrine, VPT, Syfer, Eurofarad, Texas Instruments, MS Kennedy, Miteq, Cobham, E2V, MA-COM, Hittite, Mini-Circuits, General Dynamics и др.);

Компания «Океан Электроники» является официальным дистрибьютором и эксклюзивным представителем в России одного из крупнейших производителей разъемов военного и аэрокосмического назначения «JONHON», а так же официальным дистрибьютором и эксклюзивным представителем в России производителя высокотехнологичных и надежных решений для передачи СВЧ сигналов «FORSTAR».



JONHON

«JONHON» (основан в 1970 г.)

Разъемы специального, военного и аэрокосмического назначения:

(Применяются в военной, авиационной, аэрокосмической, морской, железнодорожной, горно- и нефтедобывающей отраслях промышленности)

«FORSTAR» (основан в 1998 г.)

ВЧ соединители, коаксиальные кабели, кабельные сборки и микроволновые компоненты:

(Применяются в телекоммуникациях гражданского и специального назначения, в средствах связи, РЛС, а так же военной, авиационной и аэрокосмической отраслях промышленности).



Телефон: 8 (812) 309-75-97 (многоканальный)

Факс: 8 (812) 320-03-32

Электронная почта: ocean@oceanchips.ru

Web: <http://oceanchips.ru/>

Адрес: 198099, г. Санкт-Петербург, ул. Калинина, д. 2, корп. 4, лит. А