

DATA SHEET

SKYA21002: 0.1 to 3.0 GHz SP3T Switch

Automotive Applications

- Infotainment
- Automated toll systems
- Garage door opener
- 802.11 b/g/n WLAN, Bluetooth® systems
- Wireless control systems
- Outdoor lighting control
- Remote keyless entry
- Telematics
- GPS/Navigation

Features

- Excellent linearity performance: P1dB = +29 dBm @ 3 V
- Low insertion loss: 0.5 dB @ 2.5 GHz
- High isolation: 25 dB @ 2.5 GHz
- Positive low voltage control: 0/3 V
- Miniature, ultra-thin DFN (8-pin, 2 x 2 mm) package
- AEC-Q100 qualified at 25 °C
- JEDEC (JESD22) qualified at 25 °C
- Lead (Pb)-free and RoHS-compliant (MSL-1 @ 260 °C per JEDEC J-STD-020)



Skyworks Green™ products are compliant with all applicable legislation and are halogen-free. For additional information, refer to *Skyworks Definition of Green™*, document number SQ04-0074.

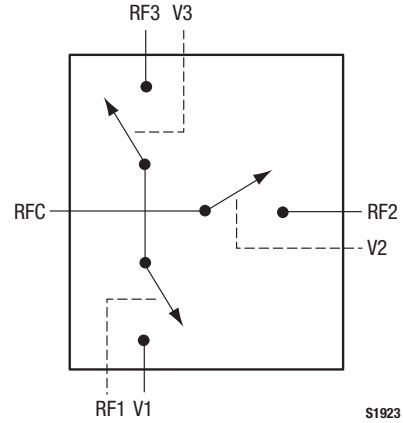

Figure 1. SKYA21002 Block Diagram

Description

The SKYA21002 is a single-pole, triple-throw (SP3T) antenna switch that operates in the 0.1 to 3.0 GHz frequency range. Switching between the antenna (RFC signal) and the RF1, RF2, and RF3 ports is accomplished with three control voltages.

The low loss, high isolation, high linearity, and small size make this switch ideal for all WLAN and Bluetooth systems operating in the 2.4 to 2.5 GHz band.

The switch is manufactured in a compact, 2 x 2 mm, 8-pin Dual Flat No-Lead (DFN) package. A functional block diagram is shown in Figure 1. The pin configuration and package are shown in Figure 2. Signal pin assignments and functional pin descriptions are provided in Table 1.

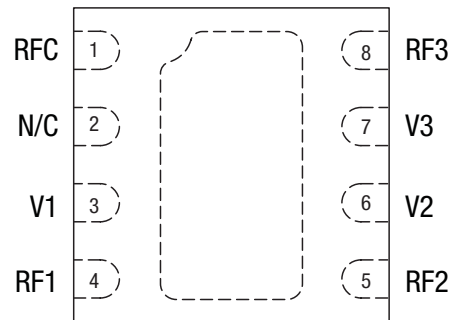

Figure 2. SKYA21002 Pinout (Top View)

Table 1. SKYA21002 Signal Descriptions

Pin	Name	Description	Pin	Name	Description
1	RFC	Antenna. DC blocking capacitor required.	5	RF2	RF port 2. DC blocking capacitor required.
2	N/C	No connection	6	V2	Switch logic control (see Table 4)
3	V1	Switch logic control (see Table 4)	7	V3	Switch logic control (see Table 4)
4	RF1	RF port 1. DC blocking capacitor required.	8	RF3	RF port 3. DC blocking capacitor required.

Electrical and Mechanical Specifications

The absolute maximum ratings of the SKYA21002 are provided in Table 2. Electrical specifications are provided in Table 3.

The state of the SKYA21002 is determined by the logic provided in Table 4. Typical performance characteristics of the SKYA21002 are shown in Figures 3 through 20.

Table 2. SKYA21002 Absolute Maximum Ratings¹

Parameter	Symbol	Minimum	Maximum	Units
Input power: @ 0/3 V @ 0/5 V	P _{IN}		+30 +32	dBm dBm
Operating voltage	V _{DD}		+8.0	V
Operating temperature	T _{OP}	-40	+85	°C
Storage temperature	T _{STG}	-65	+150	°C

¹ Exposure to maximum rating conditions for extended periods may reduce device reliability. There is no damage to device with only one parameter set at the limit and all other parameters set at or below their nominal value. Exceeding any of the limits listed here may result in permanent damage to the device.

ESD HANDLING: *Although this device is designed to be as robust as possible, electrostatic discharge (ESD) can damage this device. This device must be protected at all times from ESD when handling or transporting. Static charges may easily produce potentials of several kilovolts on the human body or equipment, which can discharge without detection. Industry-standard ESD handling precautions should be used at all times.*

Table 3. SKYA21002 Electrical Specifications¹
(V_{HIGH} = 2.1 to 5.0 V, T_{OP} = +25 °C, Unless Otherwise Noted)

Parameter	Symbol	Test Condition	Min	Typ	Max	Units
Insertion loss	IL	RFC to RF1, RF2, RF3: 0.1 to 3.0 GHz 2.4 to 2.5 GHz		0.60	0.75	dB
				0.50	0.65	dB
Return loss (insertion loss state)	IS111	RFC to RF1, RF2, RF3: 0.1 to 3.0 GHz 2.4 to 2.5 GHz		20		dB
				20		dB
Isolation	ISO	RFC to RF1, RF2, RF3: 0.1 to 3.0 GHz 2.4 to 2.5 GHz	22	25		dB
			22	25		dB
Switching speed:						
Rise time		10/90% RF		50		ns
Fall time		90/10% RF		18		ns
On time		50% control to 90/10% RF		55		ns
Off time		50% control to 90/10% RF		20		ns
Video feedthrough				40		mV
1 dB input compression point	IP1 dB	@ 2450 MHz, V _{LOW} = 0 V, V _{HIGH} = 3.3 V		+29.0		dBm
Third order input intercept point	IIP3	@ 2450 MHz, two-tone input power @ +17 dBm: V _{LOW} = 0 V, V _{HIGH} = 2.1 V V _{LOW} = 0 V, V _{HIGH} = 3.3 V		+37		dBm
				+45		dBm
Control voltage		V _{LOW} = 0 to 0.25 V @ 5 μA typical V _{HIGH} = 2.1 to 5.0 V @ 10 μA typical		0		V
				3.3		V

¹ Performance is guaranteed only under the conditions listed in this table.

Table 4. SKYA21002 Truth Table¹

V1 (Pin 3)	V2 (Pin 6)	V3 (Pin 7)	Low Insertion Loss Path
High	Low	Low	RFC to RF1
Low	High	Low	RFC to RF2
Low	Low	High	RFC to RF3

¹ High = 2.1 V to 5.0 V. Low = 0 V to 0.25 V. Any state other than described in this Table places the switch into an undefined state. An undefined state will not damage the device.

Typical Performance Characteristics

(V_{DD} = 0/3.3 V, T_{OP} = +25 °C, Unless Otherwise Noted)

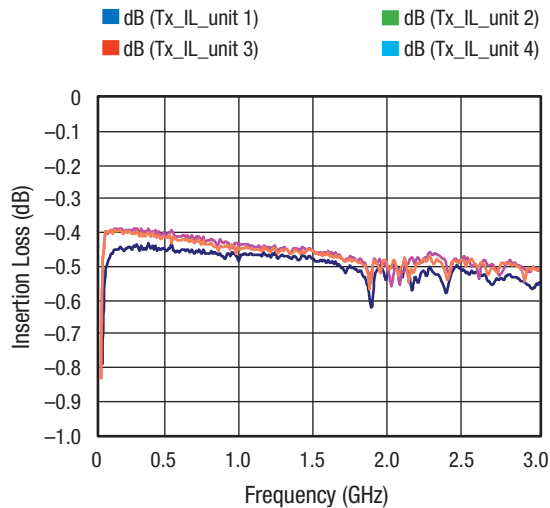

Figure 3. RFC to RF1 Insertion Loss

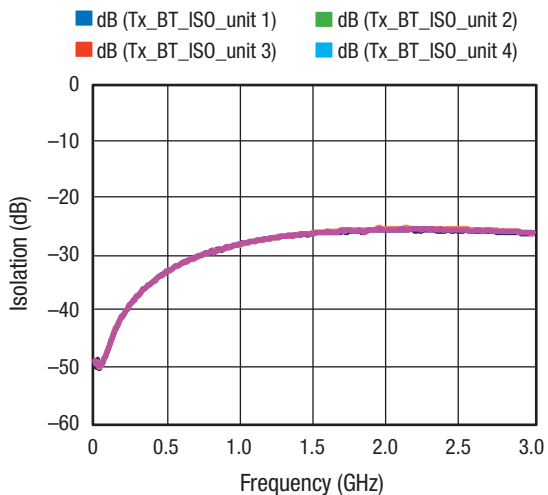

Figure 4. RFC to RF3 Isolation

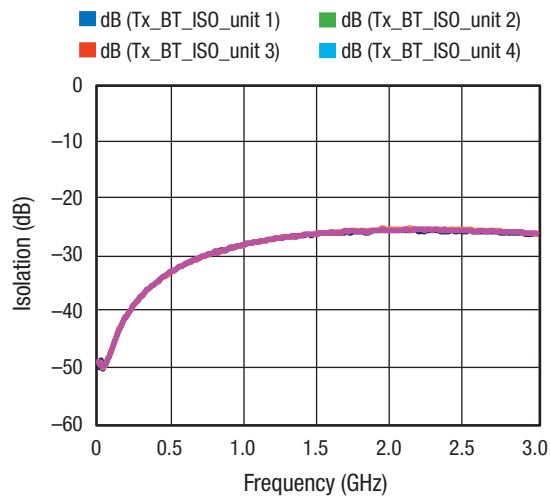

Figure 5. RFC to RF1 Return Loss

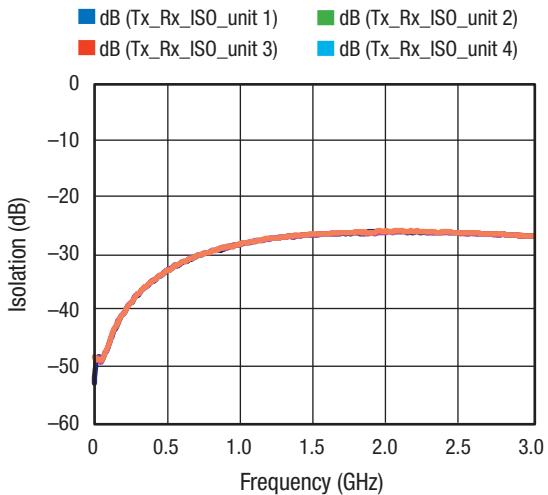

Figure 6. RFC to RF2 Isolation

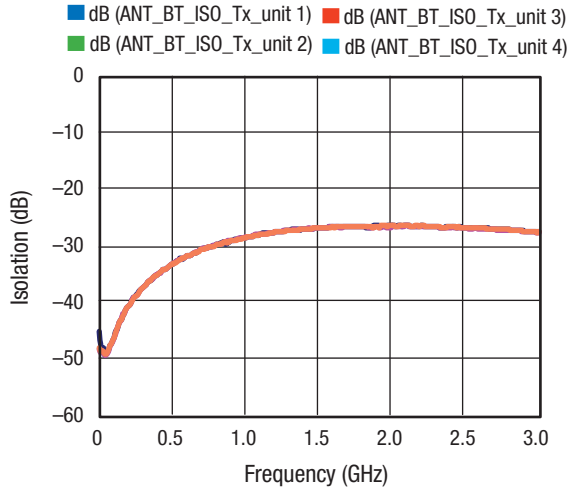

Figure 7. RF1 to RF2 Isolation

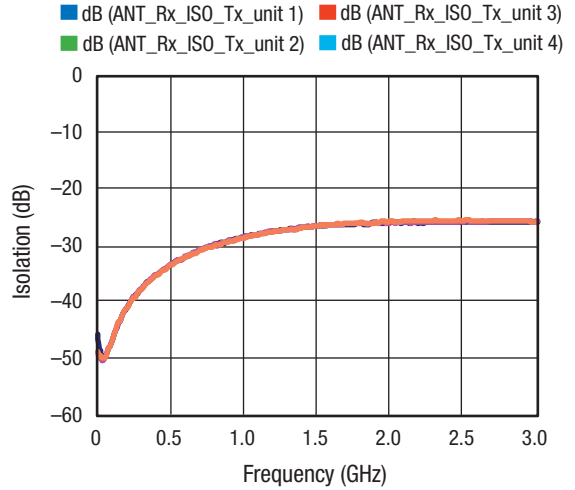

Figure 8. RF1 to RF3 Isolation

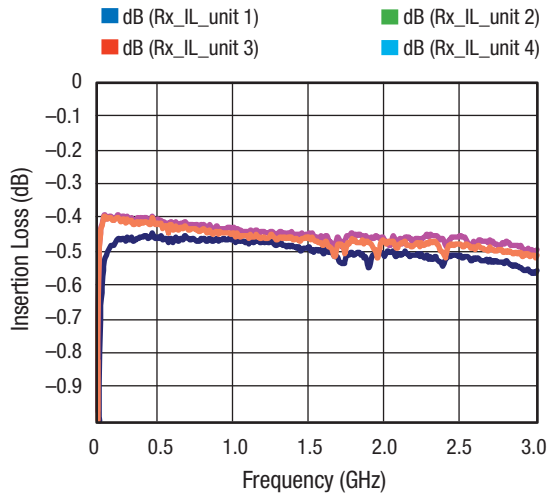

Figure 9. RFC to RF2 Insertion Loss

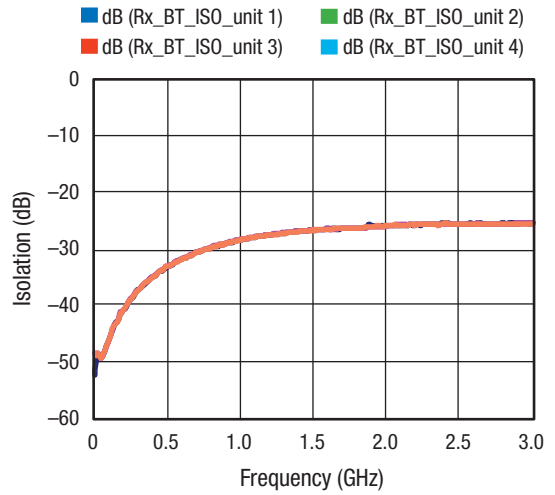

Figure 10. RFC to RF2 Isolation

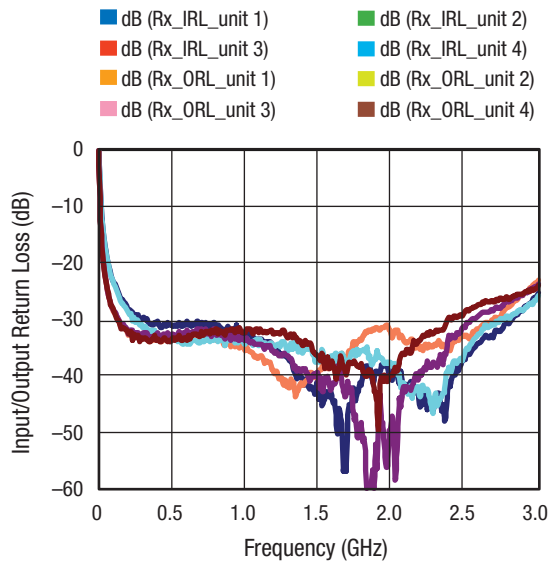

Figure 11. RFC to RF2 Return Loss

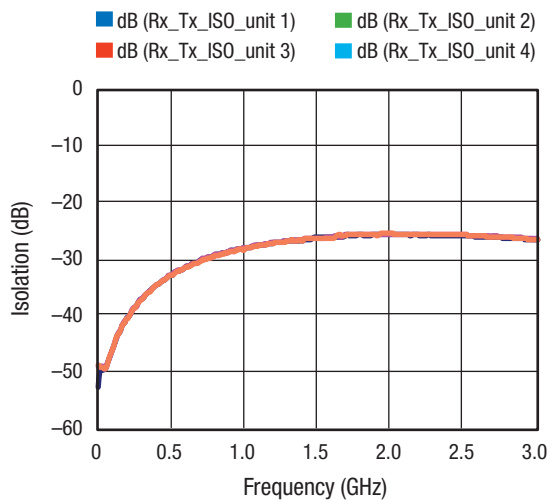

Figure 12. RFC to RF3 Isolation

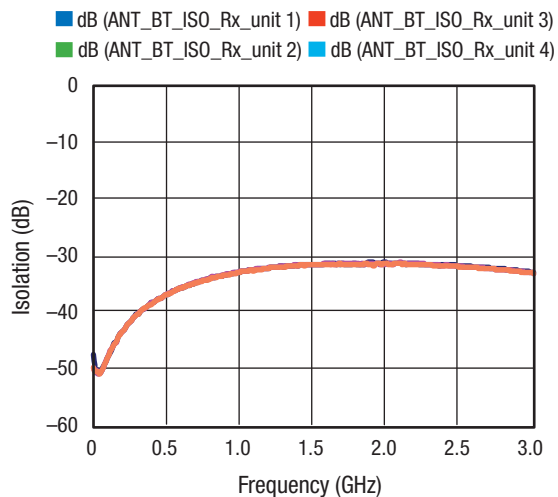

Figure 13. RF2 to RF3 Isolation

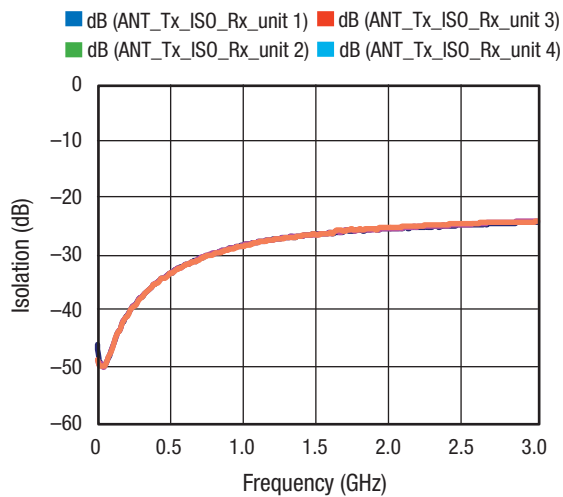

Figure 14. RF2 to RF1 Isolation

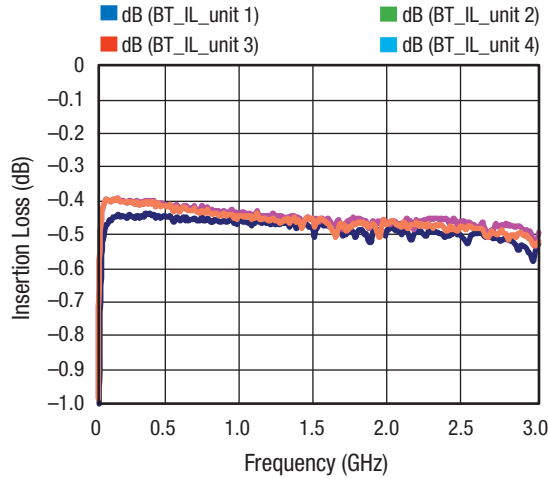

Figure 15. RFC to RF3 Insertion Loss

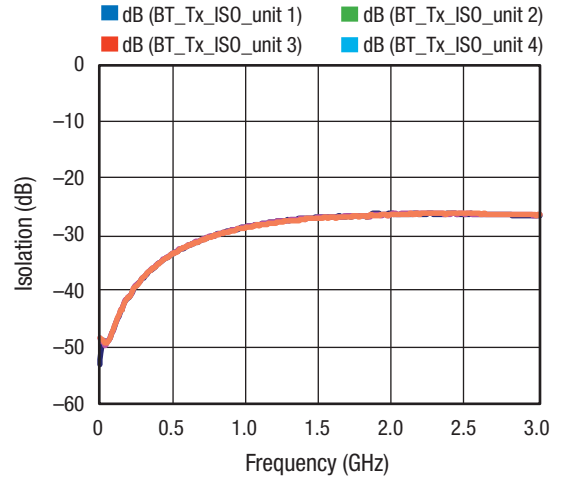

Figure 16. RFC to RF1 Isolation

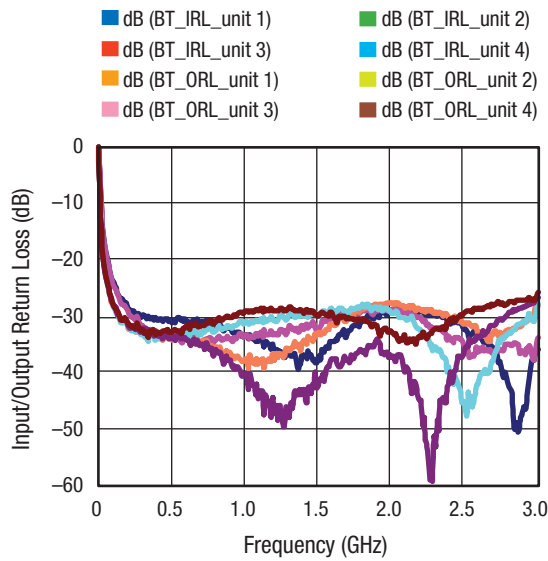

Figure 17. RFC to RF3 Return Loss

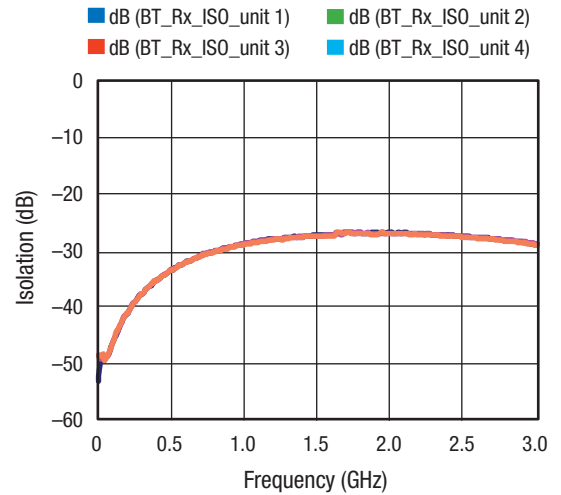

Figure 18. RFC to RF2 Isolation

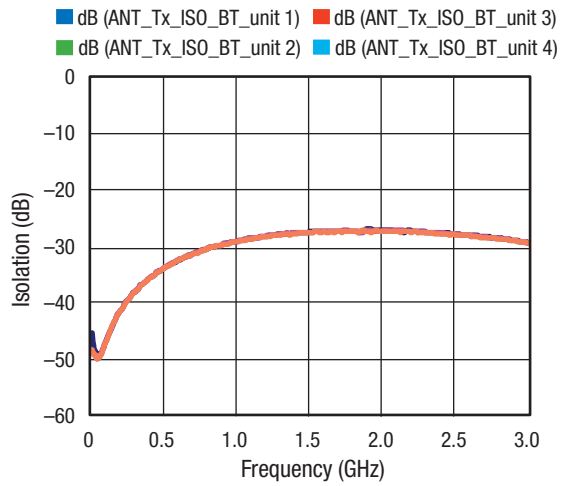

Figure 19. RF3 to RF1 Isolation

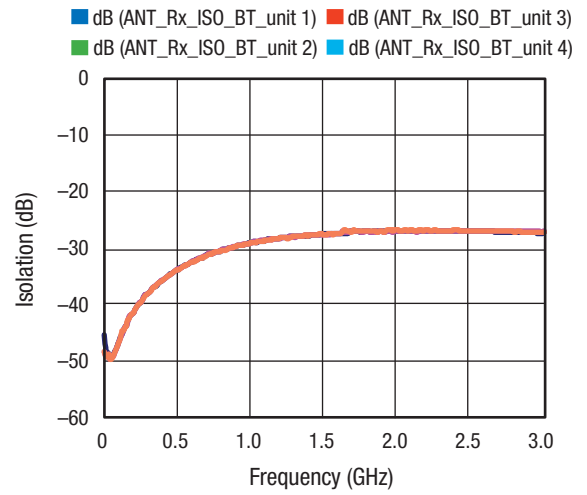
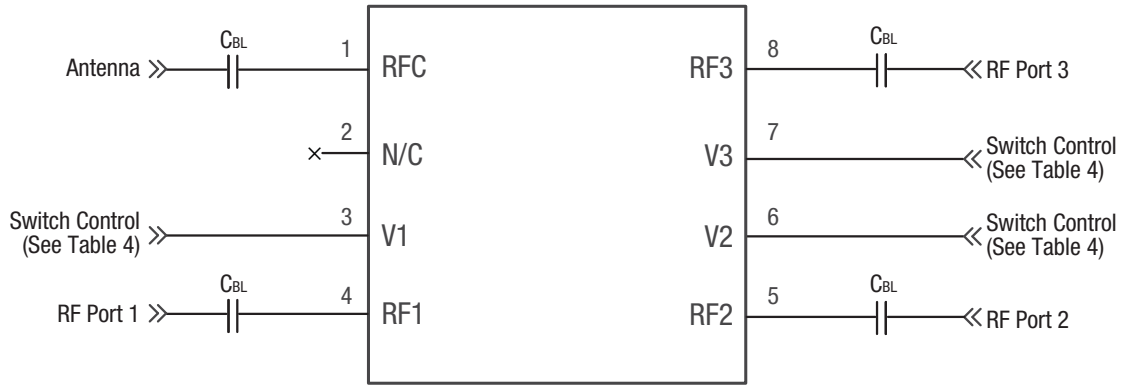

Figure 20. RF3 to RF2 Isolation

Evaluation Board Description

The SKYA21002 Evaluation Board is used to test the performance of the SKYA21002 SPDT Switch. An Evaluation Board schematic diagram is provided in Figure 21.

An assembly drawing for the Evaluation Board is shown in Figure 22.



*Note: C_{BL} = 47 pF for >500 MHz operation; 220 pF for operation down to 50 MHz.
Higher values recommended for lower frequency operation.
Exposed paddle must be grounded.*

S1925a

Figure 21. SKYA21002 Evaluation Board Schematic

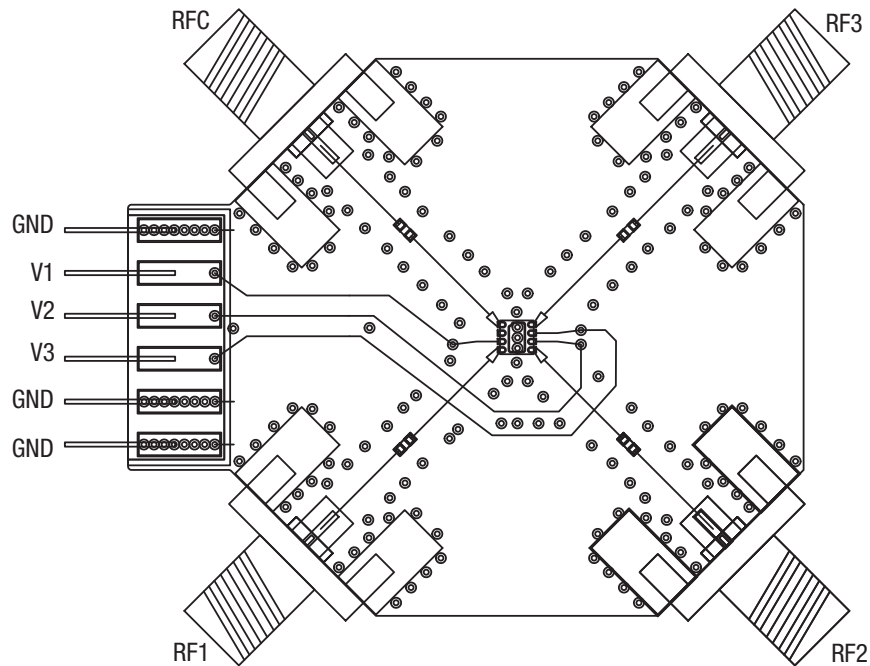

S2163

Figure 22. SKYA21002 Evaluation Board Assembly Diagram

Package Dimensions

The PCB layout footprint for the SKYA21002 is provided in Figure 23. Typical part markings are shown in Figure 24. Package dimensions are shown in Figure 25, and tape and reel dimensions are provided in Figure 26.

Package and Handling Information

Instructions on the shipping container label regarding exposure to moisture after the container seal is broken must be followed. Otherwise, problems related to moisture absorption may occur when the part is subjected to high temperature during solder assembly.

The SKYA21002 is rated to Moisture Sensitivity Level 1 (MSL1) at 260 °C. It can be used for lead or lead-free soldering. For additional information, refer to the Skyworks Application Note, *Solder Reflow Information*, document number 200164.

Care must be taken when attaching this product, whether it is done manually or in a production solder reflow environment. Production quantities of this product are shipped in a standard tape and reel format.

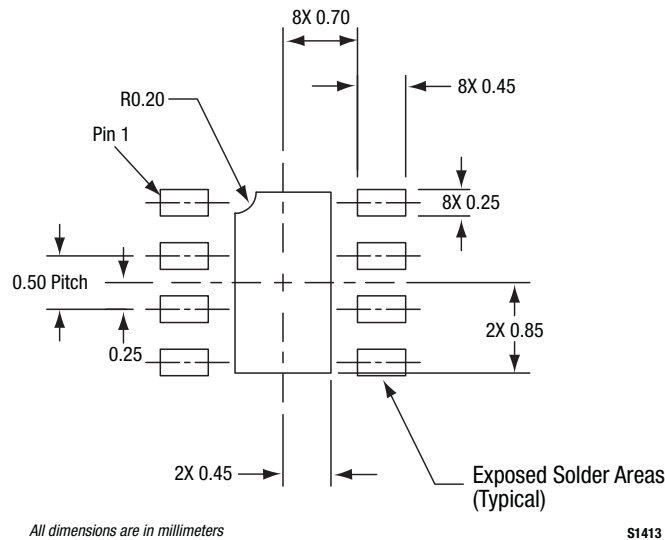

Figure 23. SKYA21002 PCB Layout Footprint (Top View)

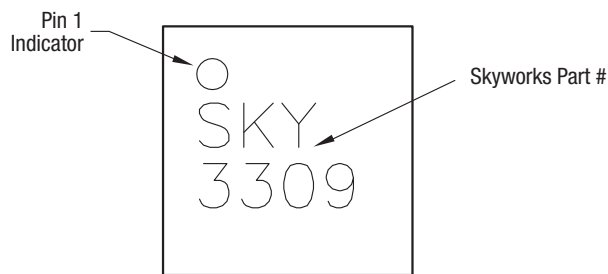
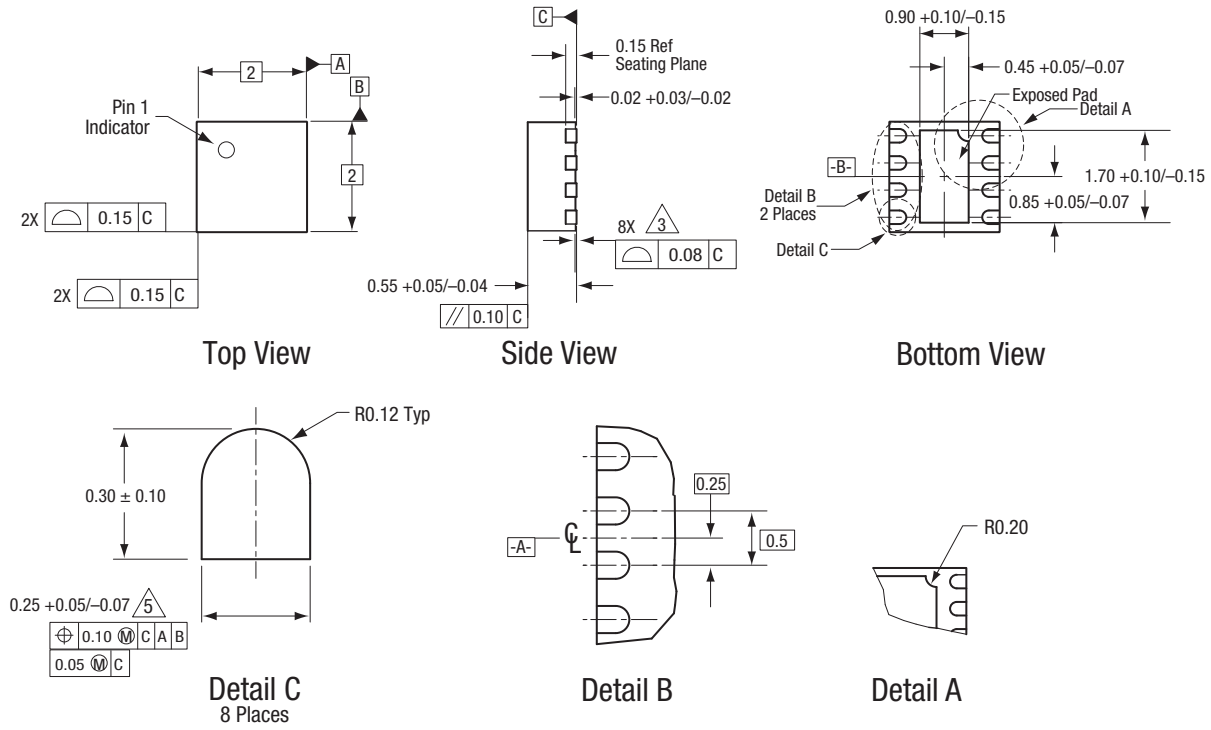

Figure 24. Typical Part Markings (Top View)



All measurements are in millimeters.
 Dimensioning and tolerancing according to ASME Y14.5M-1994.
 Coplanarity applies to the exposed heat sink slug as well as the terminals.
 Plating requirement per source control drawing (SCD) 2504.
 Dimension applies to metalized terminal and is measured between 0.15 mm and 0.30 mm from terminal tip.

S1755

Figure 25. SKYA21002 Package Dimensions

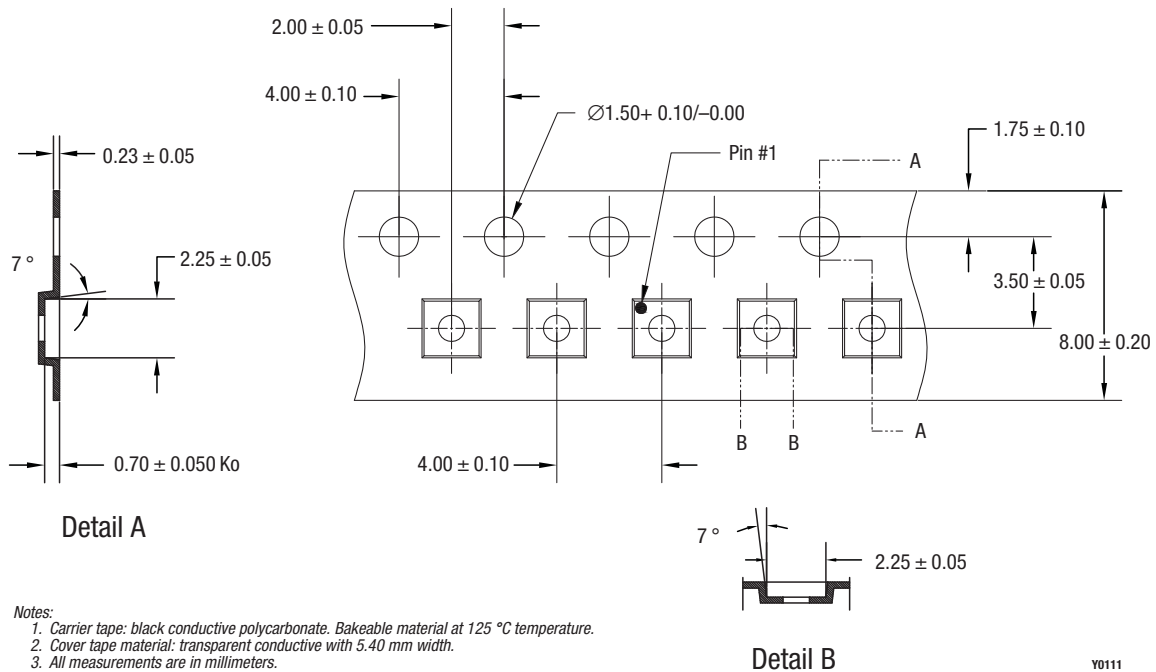

Notes:
 1. Carrier tape: black conductive polycarbonate. Bakeable material at 125 °C temperature.
 2. Cover tape material: transparent conductive with 5.40 mm width.
 3. All measurements are in millimeters.

Y0111

Figure 26. SKYA21002 Tape and Reel Dimensions

Ordering Information

Part Number	Product Description	Evaluation Board Part Number
SKYA21002	0.1 to 3.0 GHz SP3T Switch	SKYA21002-EVB

Copyright © 2013, 2018 Skyworks Solutions, Inc. All Rights Reserved.

Information in this document is provided in connection with Skyworks Solutions, Inc. (“Skyworks”) products or services. These materials, including the information contained herein, are provided by Skyworks as a service to its customers and may be used for informational purposes only by the customer. Skyworks assumes no responsibility for errors or omissions in these materials or the information contained herein. Skyworks may change its documentation, products, services, specifications or product descriptions at any time, without notice. Skyworks makes no commitment to update the materials or information and shall have no responsibility whatsoever for conflicts, incompatibilities, or other difficulties arising from any future changes.

No license, whether express, implied, by estoppel or otherwise, is granted to any intellectual property rights by this document. Skyworks assumes no liability for any materials, products or information provided hereunder, including the sale, distribution, reproduction or use of Skyworks products, information or materials, except as may be provided in Skyworks Terms and Conditions of Sale.

THE MATERIALS, PRODUCTS AND INFORMATION ARE PROVIDED “AS IS” WITHOUT WARRANTY OF ANY KIND, WHETHER EXPRESS, IMPLIED, STATUTORY, OR OTHERWISE, INCLUDING FITNESS FOR A PARTICULAR PURPOSE OR USE, MERCHANTABILITY, PERFORMANCE, QUALITY OR NON-INFRINGEMENT OF ANY INTELLECTUAL PROPERTY RIGHT; ALL SUCH WARRANTIES ARE HEREBY EXPRESSLY DISCLAIMED. SKYWORKS DOES NOT WARRANT THE ACCURACY OR COMPLETENESS OF THE INFORMATION, TEXT, GRAPHICS OR OTHER ITEMS CONTAINED WITHIN THESE MATERIALS. SKYWORKS SHALL NOT BE LIABLE FOR ANY DAMAGES, INCLUDING BUT NOT LIMITED TO ANY SPECIAL, INDIRECT, INCIDENTAL, STATUTORY, OR CONSEQUENTIAL DAMAGES, INCLUDING WITHOUT LIMITATION, LOST REVENUES OR LOST PROFITS THAT MAY RESULT FROM THE USE OF THE MATERIALS OR INFORMATION, WHETHER OR NOT THE RECIPIENT OF MATERIALS HAS BEEN ADVISED OF THE POSSIBILITY OF SUCH DAMAGE.

Skyworks products are not intended for use in medical, lifesaving or life-sustaining applications, or other equipment in which the failure of the Skyworks products could lead to personal injury, death, physical or environmental damage. Skyworks customers using or selling Skyworks products for use in such applications do so at their own risk and agree to fully indemnify Skyworks for any damages resulting from such improper use or sale.

Customers are responsible for their products and applications using Skyworks products, which may deviate from published specifications as a result of design defects, errors, or operation of products outside of published parameters or design specifications. Customers should include design and operating safeguards to minimize these and other risks. Skyworks assumes no liability for applications assistance, customer product design, or damage to any equipment resulting from the use of Skyworks products outside of stated published specifications or parameters.

Skyworks and the Skyworks symbol are trademarks or registered trademarks of Skyworks Solutions, Inc. or its subsidiaries in the United States and other countries. Third-party brands and names are for identification purposes only, and are the property of their respective owners. Additional information, including relevant terms and conditions, posted at www.skyworksinc.com, are incorporated by reference.

Компания «Океан Электроники» предлагает заключение долгосрочных отношений при поставках импортных электронных компонентов на взаимовыгодных условиях!

Наши преимущества:

- Поставка оригинальных импортных электронных компонентов напрямую с производств Америки, Европы и Азии, а так же с крупнейших складов мира;
- Широкая линейка поставок активных и пассивных импортных электронных компонентов (более 30 млн. наименований);
- Поставка сложных, дефицитных, либо снятых с производства позиций;
- Оперативные сроки поставки под заказ (от 5 рабочих дней);
- Экспресс доставка в любую точку России;
- Помощь Конструкторского Отдела и консультации квалифицированных инженеров;
- Техническая поддержка проекта, помощь в подборе аналогов, поставка прототипов;
- Поставка электронных компонентов под контролем ВП;
- Система менеджмента качества сертифицирована по Международному стандарту ISO 9001;
- При необходимости вся продукция военного и аэрокосмического назначения проходит испытания и сертификацию в лаборатории (по согласованию с заказчиком);
- Поставка специализированных компонентов военного и аэрокосмического уровня качества (Xilinx, Altera, Analog Devices, Intersil, Interpoint, Microsemi, Actel, Aeroflex, Peregrine, VPT, Syfer, Eurofarad, Texas Instruments, MS Kennedy, Miteq, Cobham, E2V, MA-COM, Hittite, Mini-Circuits, General Dynamics и др.);

Компания «Океан Электроники» является официальным дистрибьютором и эксклюзивным представителем в России одного из крупнейших производителей разъемов военного и аэрокосмического назначения «JONHON», а так же официальным дистрибьютором и эксклюзивным представителем в России производителя высокотехнологичных и надежных решений для передачи СВЧ сигналов «FORSTAR».



JONHON

«JONHON» (основан в 1970 г.)

Разъемы специального, военного и аэрокосмического назначения:

(Применяются в военной, авиационной, аэрокосмической, морской, железнодорожной, горно- и нефтедобывающей отраслях промышленности)

«FORSTAR» (основан в 1998 г.)

ВЧ соединители, коаксиальные кабели, кабельные сборки и микроволновые компоненты:

(Применяются в телекоммуникациях гражданского и специального назначения, в средствах связи, РЛС, а так же военной, авиационной и аэрокосмической отраслях промышленности).



Телефон: 8 (812) 309-75-97 (многоканальный)

Факс: 8 (812) 320-03-32

Электронная почта: ocean@oceanchips.ru

Web: <http://oceanchips.ru/>

Адрес: 198099, г. Санкт-Петербург, ул. Калинина, д. 2, корп. 4, лит. А