

General Specifications

Toggles

Rockers

Pushbuttons

Illuminated PB

Programmable

Keylocks

Rotaries

Slides

Tactiles

Tilt

Touch

Indicators

Accessories

Supplement

Electrical Capacity (Resistive Load)

Logic Level: 0.4VA maximum @ 28V AC/DC maximum
(Applicable Range 0.1mA ~ 0.1A @ 20mV ~ 28V)
See Supplement section to find explanation of operating range

Other Ratings

Contact Resistance: 80 milliohms maximum
Insulation Resistance: 100 megohms minimum @ 500V DC
Dielectric Strength: 500V AC minimum for 1 minute minimum
Mechanical Life: 30,000 cycles minimum
Electrical Life: 10,000 cycles minimum
Nominal Operating Torque: .026Nm (.234 lb•in) for momentary action models
 .020Nm (.182 lb•in) for maintained action models
Contact Timing: Break-before-make
Angle of Throw: 90° for 2-position & 45° for 3-position

Materials & Finishes

Boot: Polyvinyl chloride
Key: Brass alloy with bright nickel plating;
 brass alloy with bright nickel plating & ABS resin handle
Tumbler Barrel: Polyacetal
Bushing: Zinc alloy with nickel plating
Bracket: Steel with tin plating
Base: Glass fiber reinforced polyamide
Movable Contactor: Beryllium copper with gold plating
Stationary Contacts: Copper with gold plating
Terminals: Brass with tin plating

Environmental Data

Operating Temperature Range: -25°C through +70°C (-13°F through +158°F)
Humidity: 90 ~ 95% humidity for 240 hours @ 40°C (104°F)
Vibration: 10 ~ 55Hz with peak-to-peak amplitude of 1.5mm traversing the frequency range & returning in 1 minute; 3 right angled directions for 2 hours
Shock: 50G (490m/s²) acceleration (tested in 6 right angled directions, with 5 shocks in each direction)

PCB Processing

Soldering: Wave Soldering recommended: See Profile B in Supplement section.
 Manual Soldering: See Profile B in Supplement section.
Cleaning: Automated cleaning. Boot must be on switch during processing.
 See Cleaning specifications in Supplement section.

Standards & Certifications

These SK Series devices have not been tested for UL recognition or CSA certification. These switches are designed for use in a low-voltage, low-current, logic-level circuit. When used as intended in a logic-level circuit, the results do not produce hazardous energy.

Distinctive Characteristics

Sealed body construction plus disposable boot protect contacts and allow automated processing.

Molded-in terminals seal out flux, solvents, and other contaminants.

Short body size for space-saving, behind panel dimensions.

Detent mechanism, with its spring-operated steel ball, gives crisp, positive action for accurate switch setting.

Bifurcated, self-wiping contact mechanism provides unequalled logic-level reliability and smoother, positive detent actuation.

Crimped bracket legs ensure secure PCB mounting and prevent dislodging during automated wave soldering.

.100" x .100" (2.54mm x 2.54mm) terminal spacing conforms to standard PC board grid spacing.

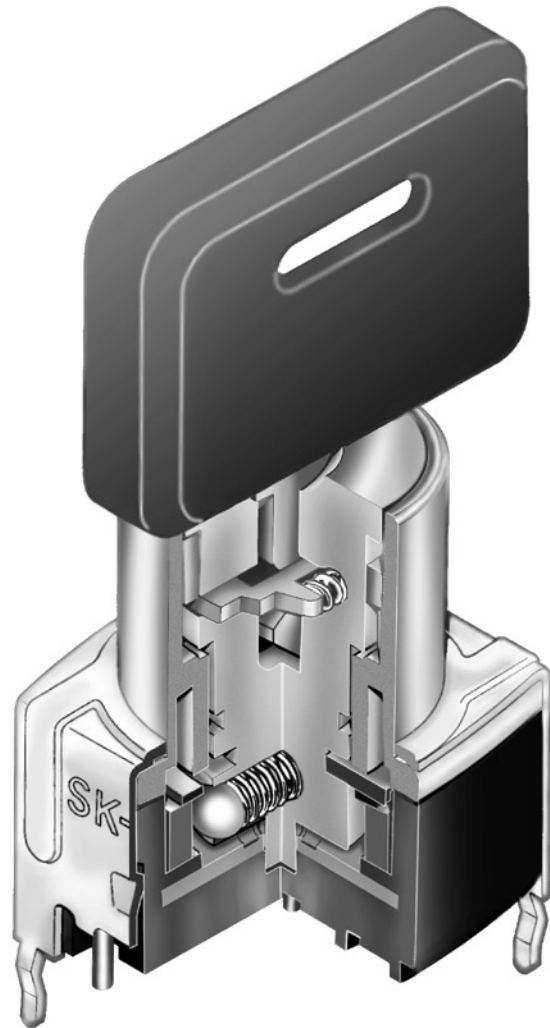

Actual Size

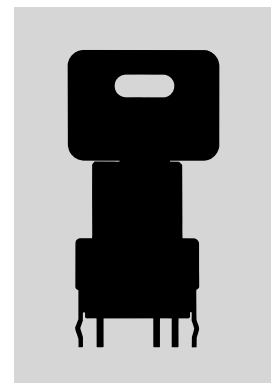

Toggles

Rockers

Pushbuttons

Illuminated PB

Programmable

F Keylocks

Rotaries

Slides

Tactiles

Tilt

Touch

Indicators

Accessories

Supplement

TYPICAL SWITCH ORDERING EXAMPLE



DESCRIPTION FOR TYPICAL ORDERING EXAMPLE

SK24EG30



Toggles
Rocker
Pushbuttons
Illuminated PB
Programmable
Keylocks
Rotaries
Slides
Tactiles
Tilt
Touch
Indicators
Accessories
Supplement

POLES, CIRCUITS & KEY-REMOVABLE POSITIONS

Pole & Throw	Model	Key Positions			Connected Terminals (Terminal numbers are not on switch)			Schematic	⊙ = Key Removable ● = Not Removable ✓ = Maximum Arc
		Pos 1	Pos 2	Pos 3	Pos 1	Pos 2	Pos 3		
SPDT	SK12A	ON	NONE	ON	C1-1	—	C1-2		
SPDT SPDT	SK12B SK15B	ON ON	NONE NONE	ON (ON)	C1-1	—	C1-2		
DPDT	SK22A	ON	NONE	ON	C1-1 C2-4	—	C1-2 C2-5		
DPDT DPDT	SK22B SK25B	ON ON	NONE NONE	ON (ON)	C1-1 C2-4	—	C1-2 C2-5		
SP3T	SK14D	ON	ON	ON	C1-1	C1-2	C1-3		
SP3T	SK14E	ON	ON	ON	C1-1	C1-2	C1-3		
DP3T	SK24D	ON	ON	ON	C1-1 C2-4	C1-2 C2-5	C1-3 C2-6		
DP3T	SK24E	ON	ON	ON	C1-1 C2-4	C1-2 C2-5	C1-3 C2-6		

KEY REMOVABLE

A Positions 1 & 3
90° Angular Throw

B Position 1
90° Angular Throw

D Positions 1, 2 & 3
45° Angular Throw

E Position 2
45° Angular Throw

CONTACT MATERIAL & RATING

G Gold over Copper

Logic Level

0.4VA maximum @ 28V AC/DC maximum

TERMINALS

13 Straight PC Terminals with Bracket

30 Right Angle PC Terminals

Double Throw Model

Three Throw Model

Double Throw Model

Three Throw Model

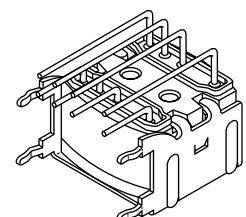
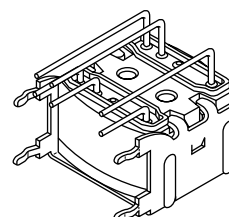
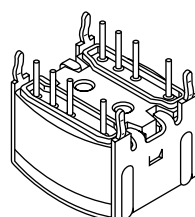
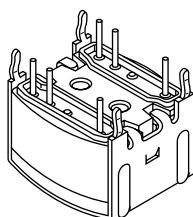

Toggles

Rockers

Pushbuttons

Programmable Illuminated PB

Keylocks

Rotaries

Slides

Tactiles

Tilt

Touch

Indicators

Accessories

Supplement

KEYS

AT4080 Standard Antistatic Plastic Handle

Brass Alloy with Bright Nickel Plating & ABS Resin Handle

2 keys supplied with each switch

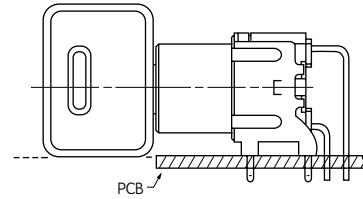
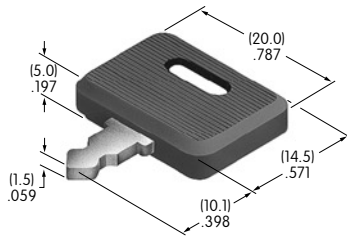

Suitable for all Straight PCB mount and for Right Angle PCB mount where clearance for key is obtainable.

AT4079 for Right Angle Mid-board Mounting (Optional) All Metal

Brass Alloy with Bright Nickel Plating

Contact factory if metal keys needed

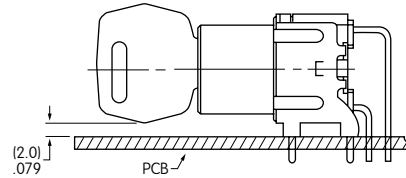
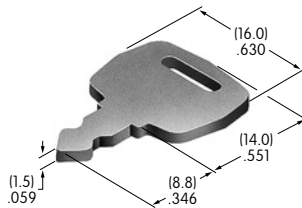

TYPICAL SWITCH DIMENSIONS

Straight PC with Bracket • Double Throw

Single & Double Pole

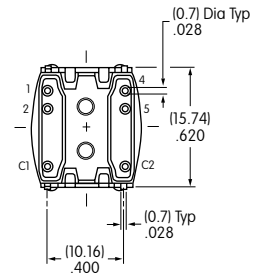
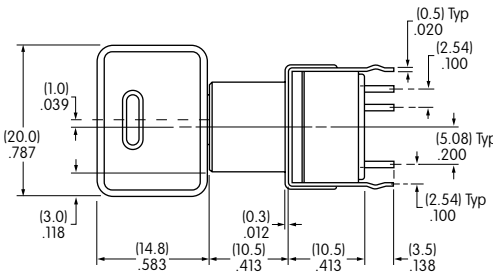
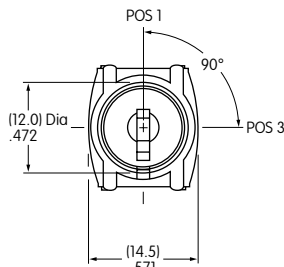

SK12AG13

Single Pole models have only terminals 1, 2 & C1

Straight PC with Bracket • Three Throw

Single & Double Pole

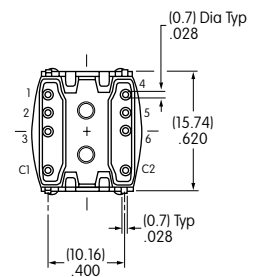
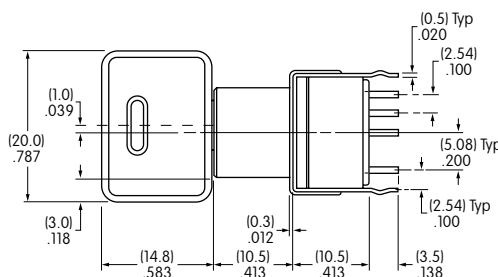
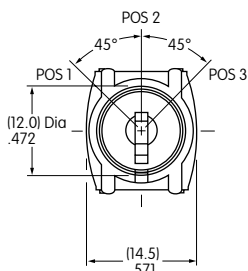

SK24DG13

Single Pole models have only terminals 1, 2, 3 & C1

TYPICAL SWITCH DIMENSIONS

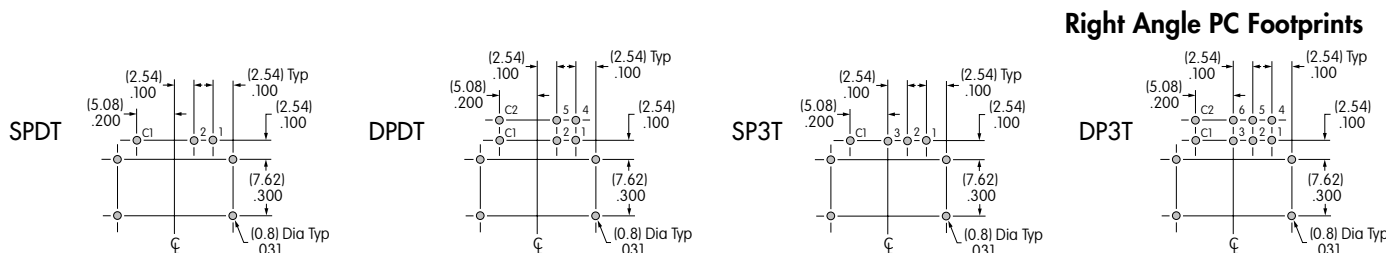
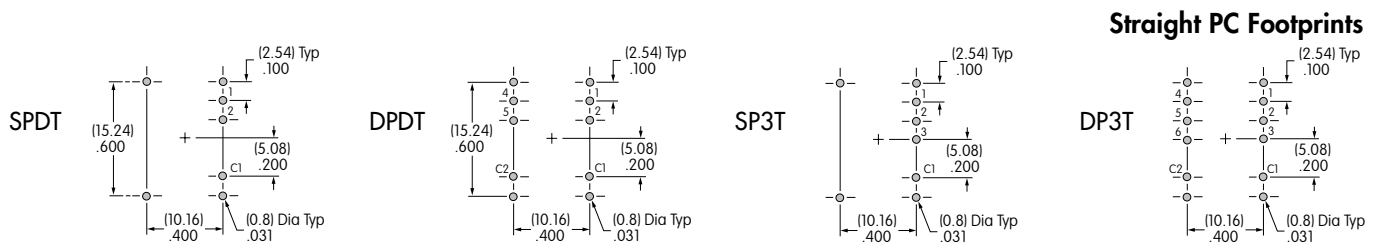
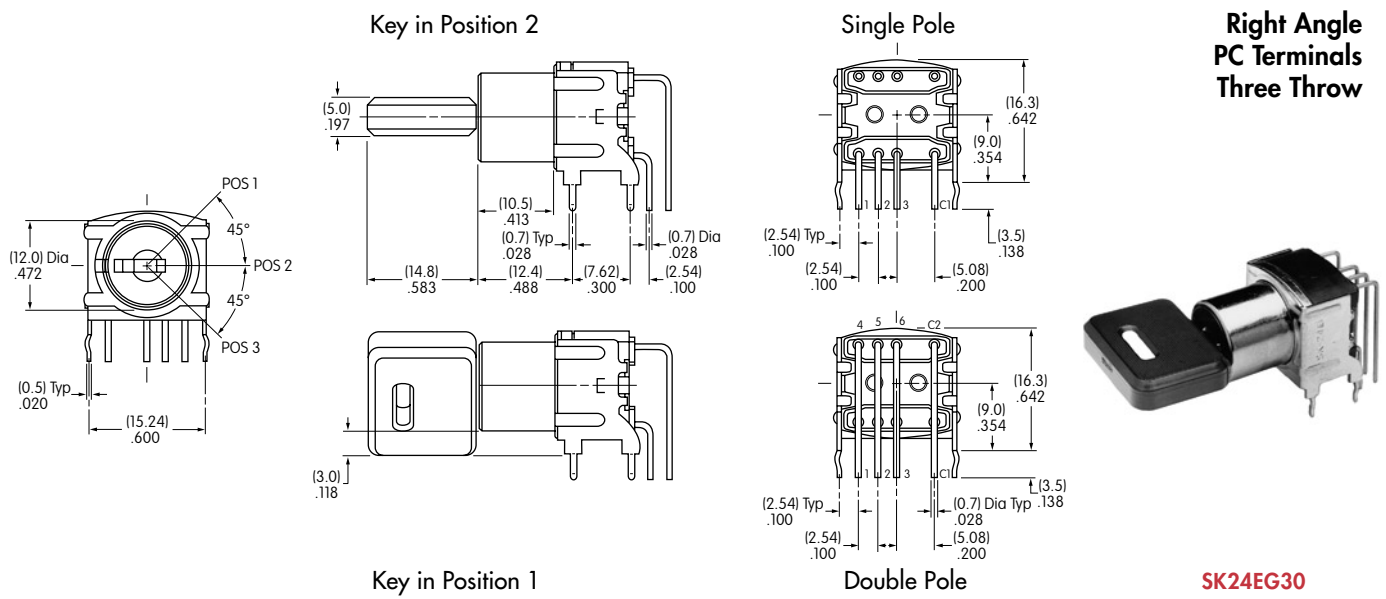
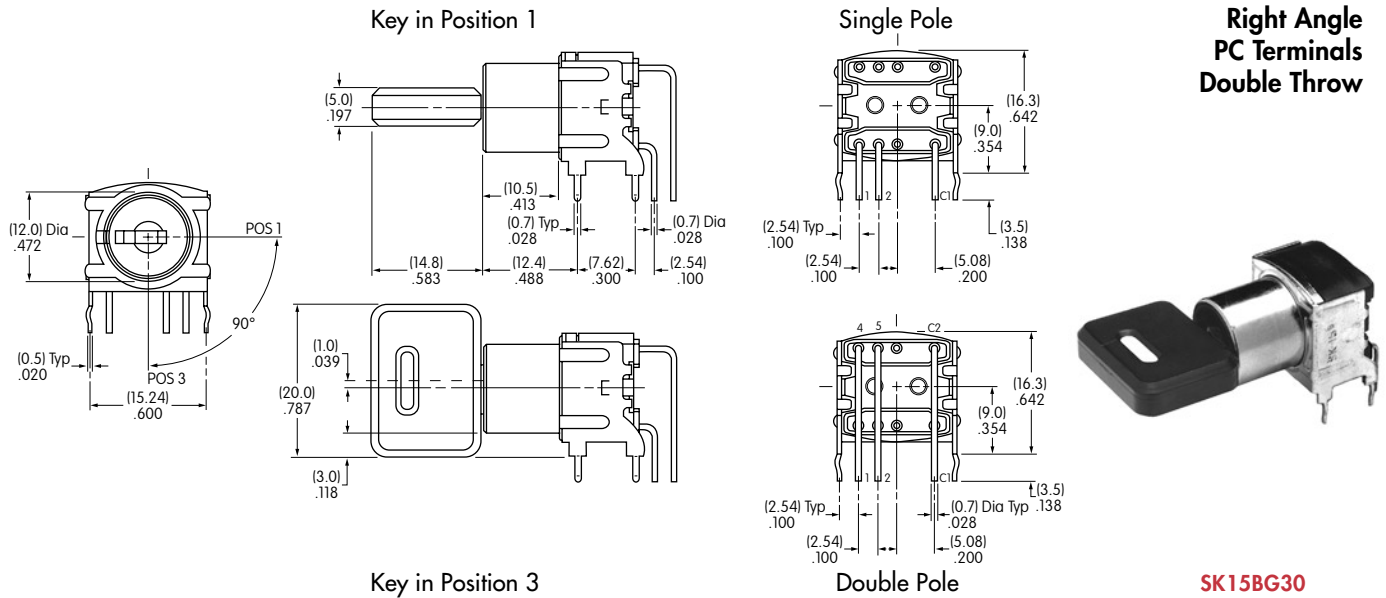

Компания «Океан Электроники» предлагает заключение долгосрочных отношений при поставках импортных электронных компонентов на взаимовыгодных условиях!

Наши преимущества:

- Поставка оригинальных импортных электронных компонентов напрямую с производств Америки, Европы и Азии, а так же с крупнейших складов мира;
- Широкая линейка поставок активных и пассивных импортных электронных компонентов (более 30 млн. наименований);
- Поставка сложных, дефицитных, либо снятых с производства позиций;
- Оперативные сроки поставки под заказ (от 5 рабочих дней);
- Экспресс доставка в любую точку России;
- Помощь Конструкторского Отдела и консультации квалифицированных инженеров;
- Техническая поддержка проекта, помощь в подборе аналогов, поставка прототипов;
- Поставка электронных компонентов под контролем ВП;
- Система менеджмента качества сертифицирована по Международному стандарту ISO 9001;
- При необходимости вся продукция военного и аэрокосмического назначения проходит испытания и сертификацию в лаборатории (по согласованию с заказчиком);
- Поставка специализированных компонентов военного и аэрокосмического уровня качества (Xilinx, Altera, Analog Devices, Intersil, Interpoint, Microsemi, Actel, Aeroflex, Peregrine, VPT, Syfer, Eurofarad, Texas Instruments, MS Kennedy, Miteq, Cobham, E2V, MA-COM, Hittite, Mini-Circuits, General Dynamics и др.);

Компания «Океан Электроники» является официальным дистрибьютором и эксклюзивным представителем в России одного из крупнейших производителей разъемов военного и аэрокосмического назначения «JONHON», а так же официальным дистрибьютором и эксклюзивным представителем в России производителя высокотехнологичных и надежных решений для передачи СВЧ сигналов «FORSTAR».



JONHON

«JONHON» (основан в 1970 г.)

Разъемы специального, военного и аэрокосмического назначения:

(Применяются в военной, авиационной, аэрокосмической, морской, железнодорожной, горно- и нефтедобывающей отраслях промышленности)

«FORSTAR» (основан в 1998 г.)

ВЧ соединители, коаксиальные кабели, кабельные сборки и микроволновые компоненты:

(Применяются в телекоммуникациях гражданского и специального назначения, в средствах связи, РЛС, а так же военной, авиационной и аэрокосмической отраслях промышленности).



Телефон: 8 (812) 309-75-97 (многоканальный)

Факс: 8 (812) 320-03-32

Электронная почта: ocean@oceanchips.ru

Web: <http://oceanchips.ru/>

Адрес: 198099, г. Санкт-Петербург, ул. Калинина, д. 2, корп. 4, лит. А