

100V P-CHANNEL ENHANCEMENT MODE MOSFET

Product Summary

BV _{DSS}	Max R _{DS(ON)}	Package	Max I _D T _A = +25°C Note 5
-100V	1.0Ω @ V _{GS} = -10V	SOT23	-0.7A
	1.45Ω @ V _{GS} = -6V		-0.5A

Description

This MOSFET utilizes a unique structure that combines the benefits of low on-resistance with fast switching speed, making it ideal for high-efficiency power management applications.

Applications

- DC - DC Converters
- Power Management Functions
- Disconnect Switches
- Motor Control

Features

- Fast Switching Speed
- Low Input Capacitance
- Low Gate Charge
- Low Threshold
- **Totally Lead-Free & Fully RoHS Compliant (Notes 1 & 2)**
- **Halogen and Antimony Free. "Green" Device (Note 3)**
- **Qualified to AEC-Q101 Standards for High Reliability**

Mechanical Data

- Case: SOT-23
- Case Material: Molded Plastic, UL Flammability Classification Rating 94V-0
- Moisture Sensitivity: Level 1 per J-STD-020
- Terminals: Matte Tin Finish annealed over Copper leadframe Solderable per MIL-STD-202, Method 208
- Weight: 0.008 grams (approximate)



Top View

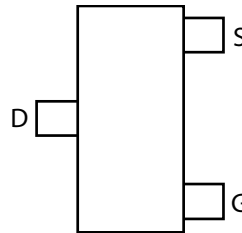

Top View
Pin Out

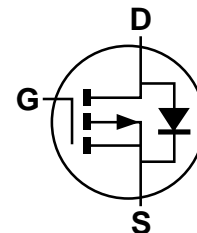

Equivalent Circuit

Ordering Information

Part Number	Marking	Reel size (inches)	Tape width (mm)	Quantity per reel
ZXMP10A13FTA	7P1	7	8	3000
ZXMP10A13FTC	7P1	13	8	10,000

- Notes:
1. No purposely added lead. Fully EU Directive 2002/95/EC (RoHS) & 2011/65/EU (RoHS 2) compliant.
 2. See <http://www.diodes.com> for more information about Diodes Incorporated's definitions of Halogen and Antimony free, "Green" and Lead-Free.
 3. Halogen and Antimony free "Green" products are defined as those which contain <900ppm bromine, <900ppm chlorine (<1500ppm total Br + Cl) and <1000ppm antimony compounds.
 4. For packaging details, go to our website at <http://www.diodes.com>.

Marking Information

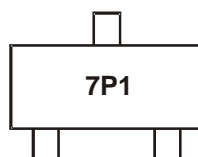

7P1 = Product Type Marking Code

Maximum Ratings (@T_A = +25°C, unless otherwise specified.)

Characteristic			Symbol	Value	Units
Drain-Source Voltage			V _{DSS}	-100	V
Gate-Source Voltage			V _{GS}	±20	V
Continuous Drain Current	V _{GS} = 10V	(Note 6)	I _D	-0.7	A
		(Note 6)		-0.5	
		(Note 5)		-0.6	
Pulsed Drain Current (Note 7)			I _{DM}	-3.1	A
Continuous Source Current (Body Diode) (Note 6)			I _S	-1.1	A
Pulsed Source Current (Body Diode) (Note 7)			I _{SM}	-3.1	A

Thermal Characteristics

Characteristic		Symbol	Value	Unit
Power Dissipation (Note 5)		P _D	625	mW
Linear Derating Factor			5	mW/°C
Power Dissipation (Note 6)		P _D	806	mW
Linear Derating Factor			6.4	mW/°C
Thermal Resistance, Junction to Ambient (Note 5)		R _{θJA}	200	°C/W
Thermal Resistance, Junction to Ambient (Note 6)		R _{θJA}	155	°C/W
Thermal Resistance, Junction to Leads (Note 8)		R _{θJL}	194	°C/W
Operating and Storage Temperature Range		T _J , T _{STG}	-55 to +150	°C

- Notes:
5. For a device surface mounted on 25mm x 25mm FR4 PCB with high coverage of single sided 1oz copper, in still air conditions
 6. For a device surface mounted on FR4 PCB measured at t ≤ 5 secs.
 7. Repetitive rating 25mm x 25mm FR4 PCB, D=0.05 pulse width=10μs - pulse current limited by maximum junction temperature.
 8. Thermal resistance from junction to solder-point (at the end of the drain lead).

Thermal Characteristics

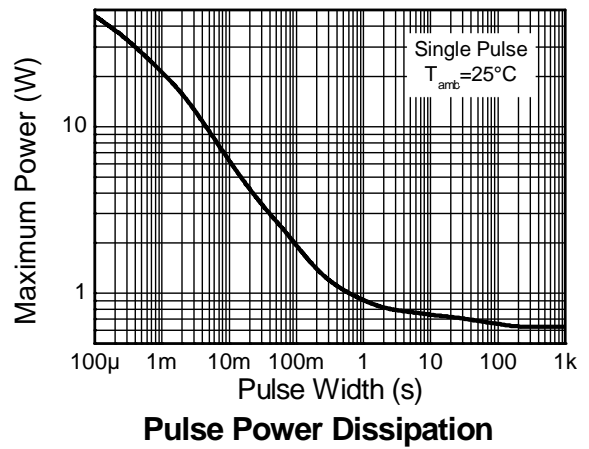
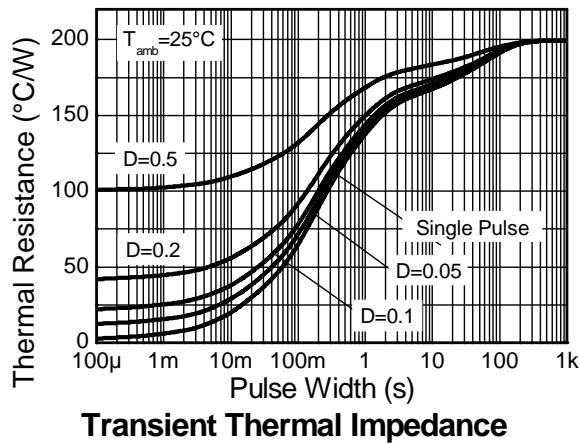
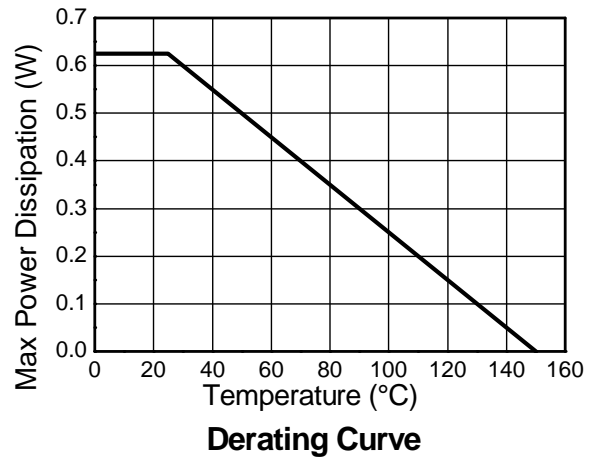
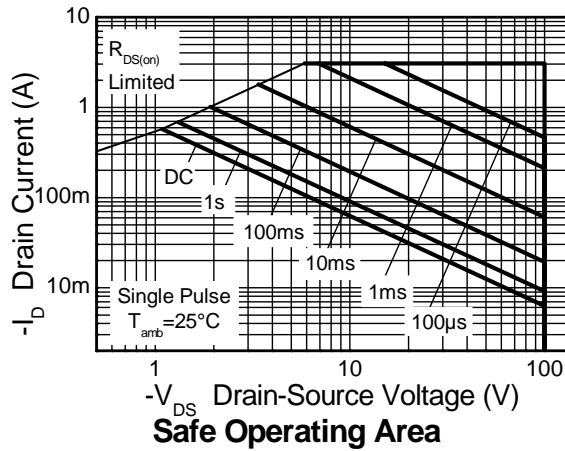

Electrical Characteristics (@T_A = +25°C, unless otherwise specified.)

Characteristic	Symbol	Min	Typ	Max	Unit	Test Condition
OFF CHARACTERISTICS						
Drain-Source Breakdown Voltage	BV _{DSS}	-100	—	—	V	I _D = -250μA, V _{GS} = 0V
Zero Gate Voltage Drain Current	I _{DSS}	—	—	-1.0	μA	V _{DS} = -100V, V _{GS} = 0V
Gate-Source Leakage	I _{GSS}	—	—	±100	nA	V _{GS} = ±20V, V _{DS} = 0V
ON CHARACTERISTICS						
Gate Threshold Voltage	V _{GS(th)}	-2.0	—	-4.0	V	I _D = -250μA, V _{DS} = V _{GS}
Static Drain-Source On-Resistance (Note 9)	R _{DS(on)}	—	—	1	Ω	V _{GS} = -10V, I _D = -0.6A
				1.45		V _{GS} = -6V, I _D = -0.5A
Forward Transconductance (Notes 9 and 11)	g _{fs}	—	1.2	—	S	V _{DS} = -15V, I _D = -0.6A
Diode Forward Voltage (Note 9)	V _{SD}	—	-0.85	-0.95	V	T _J = 25°C, I _S = -0.75A, V _{GS} = 0V
Reverse Recovery Time (Note 11)	t _{rr}	—	29	—	ns	T _J = 25°C, I _F = -0.9A,
Reverse Recovery Charge (Note 11)	Q _{rr}	—	31	—	nC	di/dt = 100A/μs
DYNAMIC CHARACTERISTICS (Note 11)						
Input Capacitance	C _{iSS}	—	141	—	pF	V _{DS} = -50V, V _{GS} = 0V f = 1.0MHz
Output Capacitance	C _{oss}	—	13.1	—		
Reverse Transfer Capacitance	C _{rSS}	—	10.8	—		
Turn-On Delay Time (Note 10)	t _{D(on)}	—	1.6	—	ns	V _{DD} = -50V, I _D = -1A, R _G ≅ 6.0Ω, V _{GS} = -10V
Turn-On Rise Time (Note 10)	t _r	—	2.1	—		
Turn-Off Delay Time (Note 10)	t _{D(off)}	—	5.9	—		
Turn-Off Fall Time (Note 10)	t _f	—	3.3	—		
Total Gate Charge (Note 10)	Q _g	—	1.8	—	nC	V _{DS} = -50V, V _{GS} = -5V, I _D = -0.6A
Total Gate Charge (Note 10)	Q _g	—	3.5	—	nC	V _{DS} = -50V, V _{GS} = -10V, I _D = -0.6A
Gate-Source Charge (Note 10)	Q _{gs}	—	0.6	—		
Gate-Drain Charge (Note 10)	Q _{gd}	—	1.6	—		

- Notes: 9. Measured under pulsed conditions. Pulse width = 300μs. Duty cycle ≤ 2%.
 10. Switching characteristics are independent of operating junction temperature.
 11. For design aid only, not subject to production testing.

Typical Characteristics

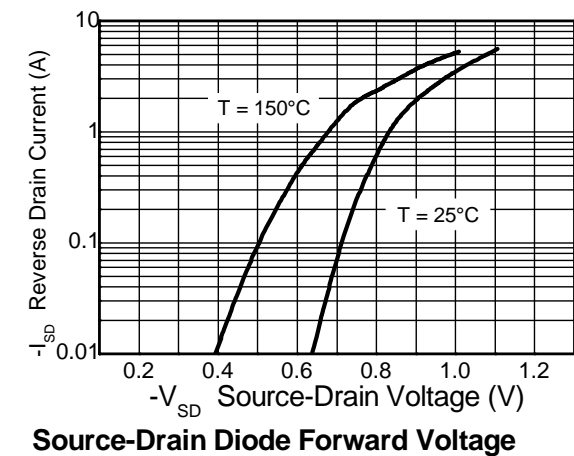
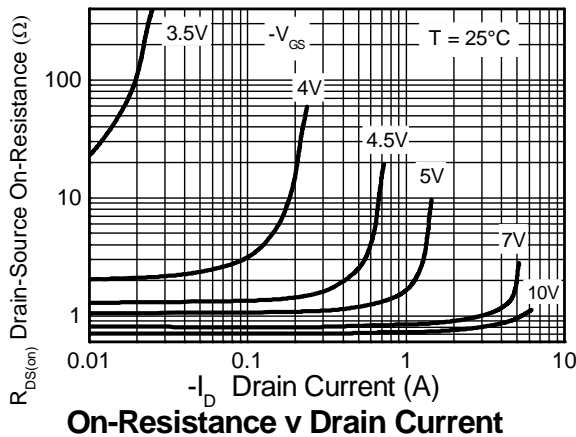
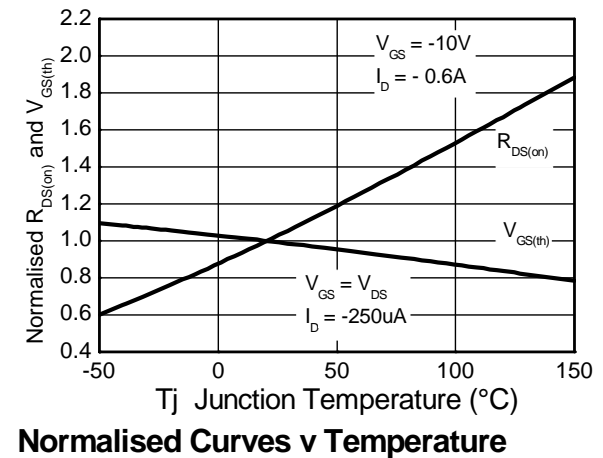
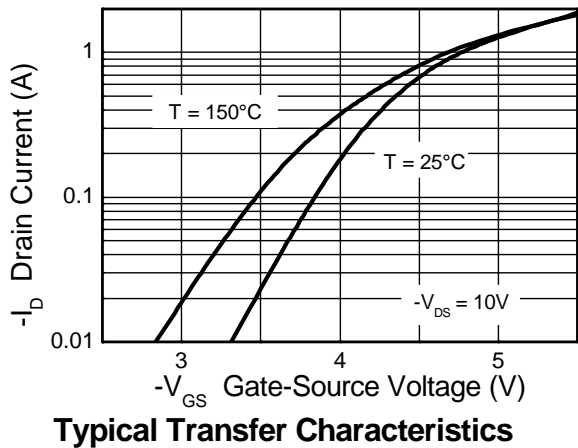
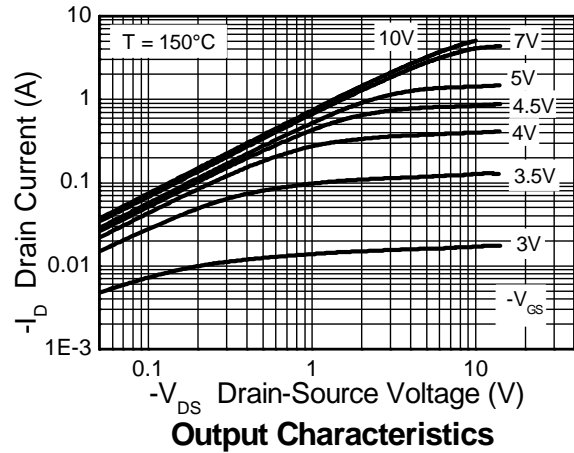
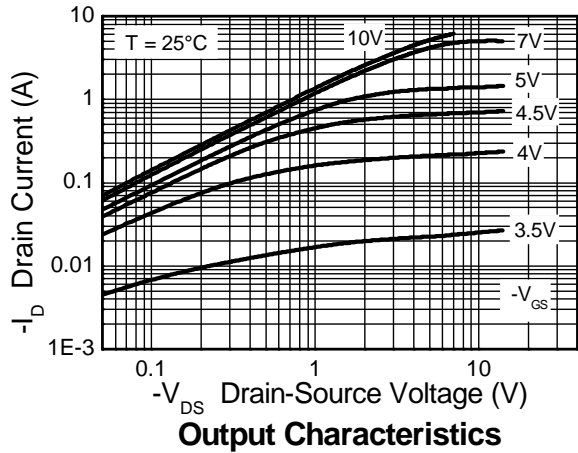

Typical Characteristics (cont.)

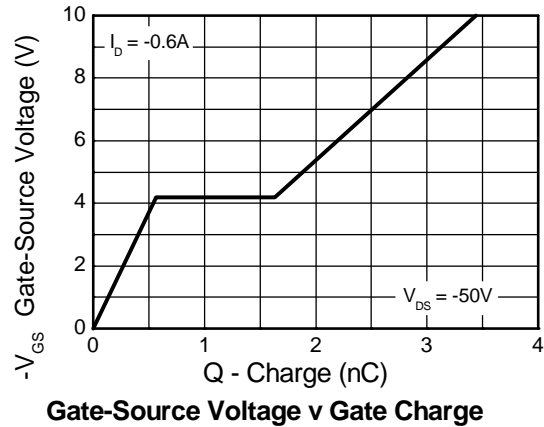
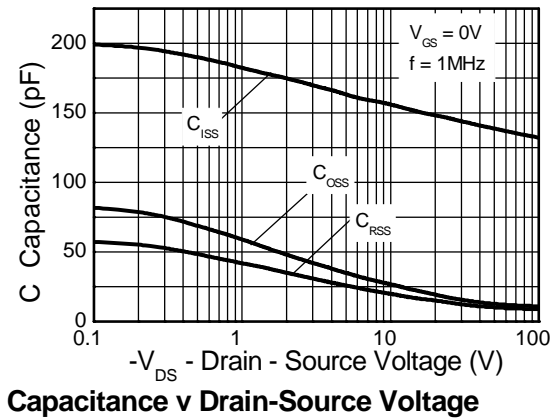

Test Circuits

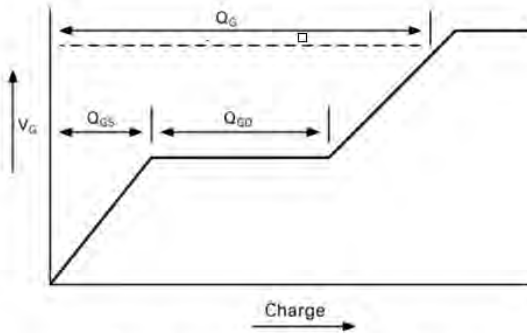

Basic gate charge waveform

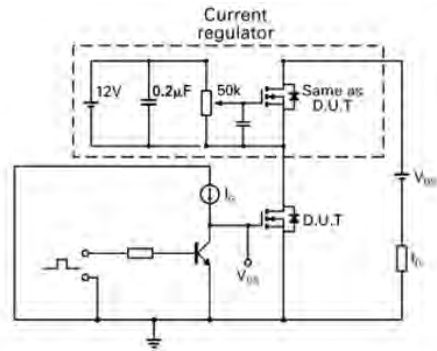

Gate charge test circuit

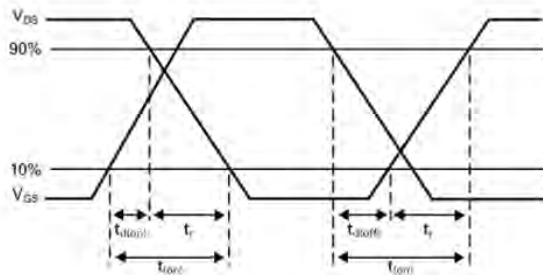

Switching time waveforms

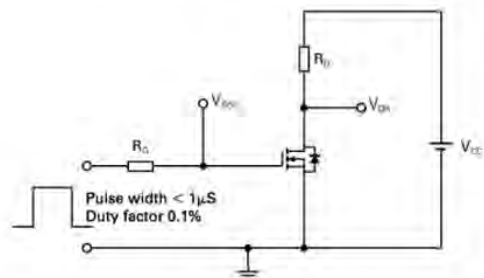

Switching time test circuit

ZXMP10A13F

Package Outline Dimensions

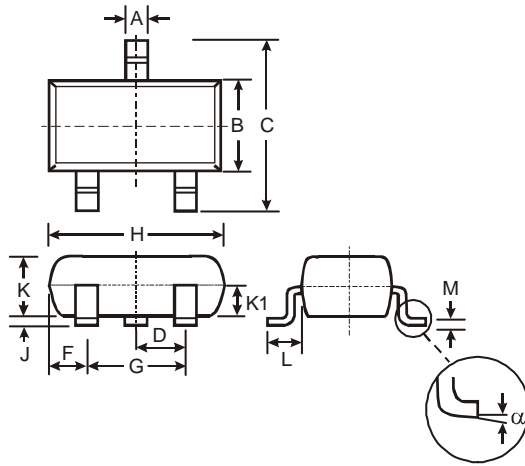

SOT23			
Dim	Min	Max	Typ
A	0.37	0.51	0.40
B	1.20	1.40	1.30
C	2.30	2.50	2.40
D	0.89	1.03	0.915
F	0.45	0.60	0.535
G	1.78	2.05	1.83
H	2.80	3.00	2.90
J	0.013	0.10	0.05
K	0.903	1.10	1.00
K1	-	-	0.400
L	0.45	0.61	0.55
M	0.085	0.18	0.11
α	0°	8°	-
All Dimensions in mm			

Suggested Pad Layout

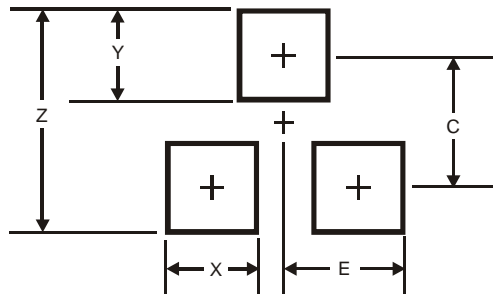

Dimensions	Value (in mm)
Z	2.9
X	0.8
Y	0.9
C	2.0
E	1.35

IMPORTANT NOTICE

DIODES INCORPORATED MAKES NO WARRANTY OF ANY KIND, EXPRESS OR IMPLIED, WITH REGARDS TO THIS DOCUMENT, INCLUDING, BUT NOT LIMITED TO, THE IMPLIED WARRANTIES OF MERCHANTABILITY AND FITNESS FOR A PARTICULAR PURPOSE (AND THEIR EQUIVALENTS UNDER THE LAWS OF ANY JURISDICTION).

Diodes Incorporated and its subsidiaries reserve the right to make modifications, enhancements, improvements, corrections or other changes without further notice to this document and any product described herein. Diodes Incorporated does not assume any liability arising out of the application or use of this document or any product described herein; neither does Diodes Incorporated convey any license under its patent or trademark rights, nor the rights of others. Any Customer or user of this document or products described herein in such applications shall assume all risks of such use and will agree to hold Diodes Incorporated and all the companies whose products are represented on Diodes Incorporated website, harmless against all damages.

Diodes Incorporated does not warrant or accept any liability whatsoever in respect of any products purchased through unauthorized sales channel. Should Customers purchase or use Diodes Incorporated products for any unintended or unauthorized application, Customers shall indemnify and hold Diodes Incorporated and its representatives harmless against all claims, damages, expenses, and attorney fees arising out of, directly or indirectly, any claim of personal injury or death associated with such unintended or unauthorized application.

Products described herein may be covered by one or more United States, international or foreign patents pending. Product names and markings noted herein may also be covered by one or more United States, international or foreign trademarks.

LIFE SUPPORT

Diodes Incorporated products are specifically not authorized for use as critical components in life support devices or systems without the express written approval of the Chief Executive Officer of Diodes Incorporated. As used herein:

A. Life support devices or systems are devices or systems which:

1. are intended to implant into the body, or
2. support or sustain life and whose failure to perform when properly used in accordance with instructions for use provided in the labeling can be reasonably expected to result in significant injury to the user.

B. A critical component is any component in a life support device or system whose failure to perform can be reasonably expected to cause the failure of the life support device or to affect its safety or effectiveness.

Customers represent that they have all necessary expertise in the safety and regulatory ramifications of their life support devices or systems, and acknowledge and agree that they are solely responsible for all legal, regulatory and safety-related requirements concerning their products and any use of Diodes Incorporated products in such safety-critical, life support devices or systems, notwithstanding any devices- or systems-related information or support that may be provided by Diodes Incorporated. Further, Customers must fully indemnify Diodes Incorporated and its representatives against any damages arising out of the use of Diodes Incorporated products in such safety-critical, life support devices or systems.

Copyright © 2012, Diodes Incorporated

www.diodes.com

Компания «Океан Электроники» предлагает заключение долгосрочных отношений при поставках импортных электронных компонентов на взаимовыгодных условиях!

Наши преимущества:

- Поставка оригинальных импортных электронных компонентов напрямую с производств Америки, Европы и Азии, а так же с крупнейших складов мира;
- Широкая линейка поставок активных и пассивных импортных электронных компонентов (более 30 млн. наименований);
- Поставка сложных, дефицитных, либо снятых с производства позиций;
- Оперативные сроки поставки под заказ (от 5 рабочих дней);
- Экспресс доставка в любую точку России;
- Помощь Конструкторского Отдела и консультации квалифицированных инженеров;
- Техническая поддержка проекта, помощь в подборе аналогов, поставка прототипов;
- Поставка электронных компонентов под контролем ВП;
- Система менеджмента качества сертифицирована по Международному стандарту ISO 9001;
- При необходимости вся продукция военного и аэрокосмического назначения проходит испытания и сертификацию в лаборатории (по согласованию с заказчиком);
- Поставка специализированных компонентов военного и аэрокосмического уровня качества (Xilinx, Altera, Analog Devices, Intersil, Interpoint, Microsemi, Actel, Aeroflex, Peregrine, VPT, Syfer, Eurofarad, Texas Instruments, MS Kennedy, Miteq, Cobham, E2V, MA-COM, Hittite, Mini-Circuits, General Dynamics и др.);

Компания «Океан Электроники» является официальным дистрибьютором и эксклюзивным представителем в России одного из крупнейших производителей разъемов военного и аэрокосмического назначения «JONHON», а так же официальным дистрибьютором и эксклюзивным представителем в России производителя высокотехнологичных и надежных решений для передачи СВЧ сигналов «FORSTAR».



JONHON

«JONHON» (основан в 1970 г.)

Разъемы специального, военного и аэрокосмического назначения:

(Применяются в военной, авиационной, аэрокосмической, морской, железнодорожной, горно- и нефтедобывающей отраслях промышленности)

«FORSTAR» (основан в 1998 г.)

ВЧ соединители, коаксиальные кабели, кабельные сборки и микроволновые компоненты:

(Применяются в телекоммуникациях гражданского и специального назначения, в средствах связи, РЛС, а так же военной, авиационной и аэрокосмической отраслях промышленности).



Телефон: 8 (812) 309-75-97 (многоканальный)

Факс: 8 (812) 320-03-32

Электронная почта: ocean@oceanchips.ru

Web: <http://oceanchips.ru/>

Адрес: 198099, г. Санкт-Петербург, ул. Калинина, д. 2, корп. 4, лит. А