

### 0.5A/1A PWM/VFM Step-down DC/DC Converter with Synchronous Rectifier

NO.EA-362-160510

#### OUTLINE

The RP509x is a low supply current CMOS-based PWM/VFM step-down DC/DC converter with synchronous rectifier featuring 0.5 A / 1 A output current<sup>(1)</sup>. Internally, a single converter consists of a reference voltage unit, an error amplifier, a switching control circuit, a mode control circuit, a soft-start circuit, an under-voltage lockout (UVLO) circuit, a thermal shutdown circuit, and switching transistors. The RP509x is employing synchronous rectification for improving the efficiency of rectification by replacing diodes with built-in switching transistors. Using synchronous rectification not only increases circuit performance but also allows a design to reduce parts count. Output voltage controlling method is selectable between a forced PWM control type and a PWM/VFM auto-switching control type, and can be set by the MODE pin. Output voltage type is selectable between an internally fixed output voltage type and an externally adjustable output voltage type. Protection circuits in the RP509x is current limit circuit and thermal shutdown circuit. LX current limit value (Typ.) is selectable between 1.6 A and 1.0 A.

The RP509Z is available in WLCSP-6-P6 which achieves high-density mounting on boards. Using capacitor of 0402- / 1005-size (inch / mm) and inductor of 0603- / 1608-size (inch / mm) as external parts help to save space for devices. The RP509N under development is available in SOT-23-6.

#### FEATURES

- Input Voltage Range (Maximum Rating) .....2.3 V to 5.5 V (6.5 V)
- Output Voltage Range (Fixed Output Voltage Type) .....0.6 V to 3.3 V - Settable in 0.1 V Step  
(Adjustable Output Voltage Type) .....0.6 V to 5.5 V
- Output Voltage Accuracy (Fixed Output Voltage Type) .....±1.5% ( $V_{SET}^{(2)} \geq 1.2 V$ ), ±18 mV ( $V_{SET} < 1.2 V$ )
- Feedback Voltage Accuracy  
(Adjustable Output Voltage Type) .....±9 mV ( $V_{FB} = 0.6 V$ )
- Output Voltage/Feedback Voltage Temperature Coefficient... ±100 ppm/°C
- Selectable Oscillator Frequency ..... Typ. 6.0 MHz
- Oscillator Maximum Duty ..... Min. 100%
- Built-in Driver ON Resistance ( $V_{IN} = 3.6 V$ )..... Typ. Pch. 0.175  $\Omega$ , Nch. 0.155  $\Omega$  (RP509Z)
- Standby Current..... Typ. 0  $\mu A$
- UVLO Detector Threshold ..... Typ. 2.0 V
- Soft-start Time ..... Typ. 0.15 ms
- Inductor Current Limit Circuit..... Typ. 1.6 A / 1.0 A - Selectable Current Limit
- Package..... WLCSP-6-P6 (1.28 mm x 0.88 mm)  
SOT-23-6 《under development》

<sup>(1)</sup> This is an approximate value. The output current is dependent on conditions and external components.

<sup>(2)</sup>  $V_{SET}$  = Set Output Voltage

---

## RP509x

---

NO.EA-362-160510

### APPLICATION

- Power source for Portable communication equipment such as mobile/smart phone, digital camera, and Note-PC
- Power source for Li-ion battery-used equipment

### SELECTION GUIDE

The set output voltage, the output voltage type, the auto-discharge function<sup>(1)</sup>, and the LX current limit for the ICs are user-selectable options.

#### Selection Guide

Product Name	Package	Quantity per Reel	Pb Free	Halogen Free
RP509ZxxX\$-E2-F	WLCSP-6-P6	5,000 pcs	Yes	Yes
RP509NxxX\$-TR-FE 《under development》	SOT-23-6	3,000 pcs	Yes	Yes

xx: Designation of the set output voltage ( $V_{SET}$ )

For Fixed Output Voltage Type: 0.6 V (06) to 3.3 V (33) in 0.1 V steps<sup>(2)</sup>

For Adjustable Output Voltage Type: 00 only

X: Designation of LX Current Limit

1) Typ. 1.6 A

2) Typ. 1.0 A

\$: Designation of Version

Version	Output Voltage Type	Auto-discharge Function	Oscillator Frequency	$V_{SET}$
A	Fixed	No	6.0 MHz	0.6 V to 3.3 V
B		Yes		
C	Adjustable	No		0.6 V to 5.5 V
D		Yes		

---

<sup>(1)</sup> Auto-discharge function quickly lowers the output voltage to 0 V, when the chip enable signal is switched from the active mode to the standby mode, by releasing the electrical charge accumulated in the external capacitor.

<sup>(2)</sup> 0.05 V step is also available as a custom code.

---

### BLOCK DIAGRAM

RP509ZxxXA/B, RP509NxxXA/B **《under development》** (Fixed Output Voltage Type)

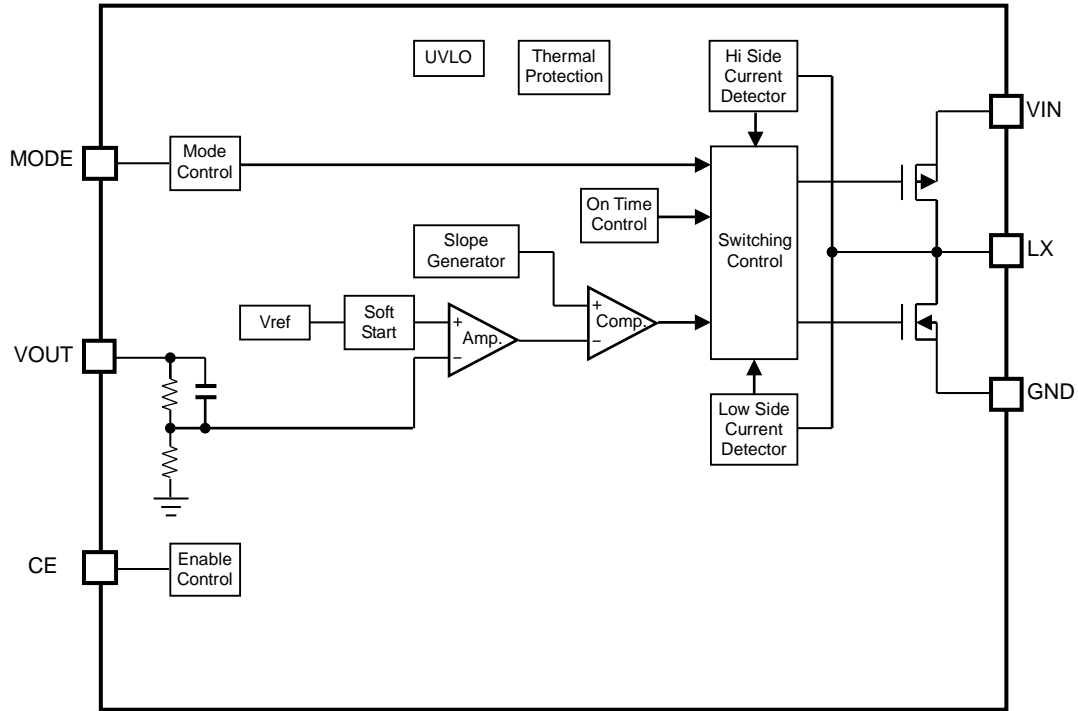

RP509xxxXA Block Diagram

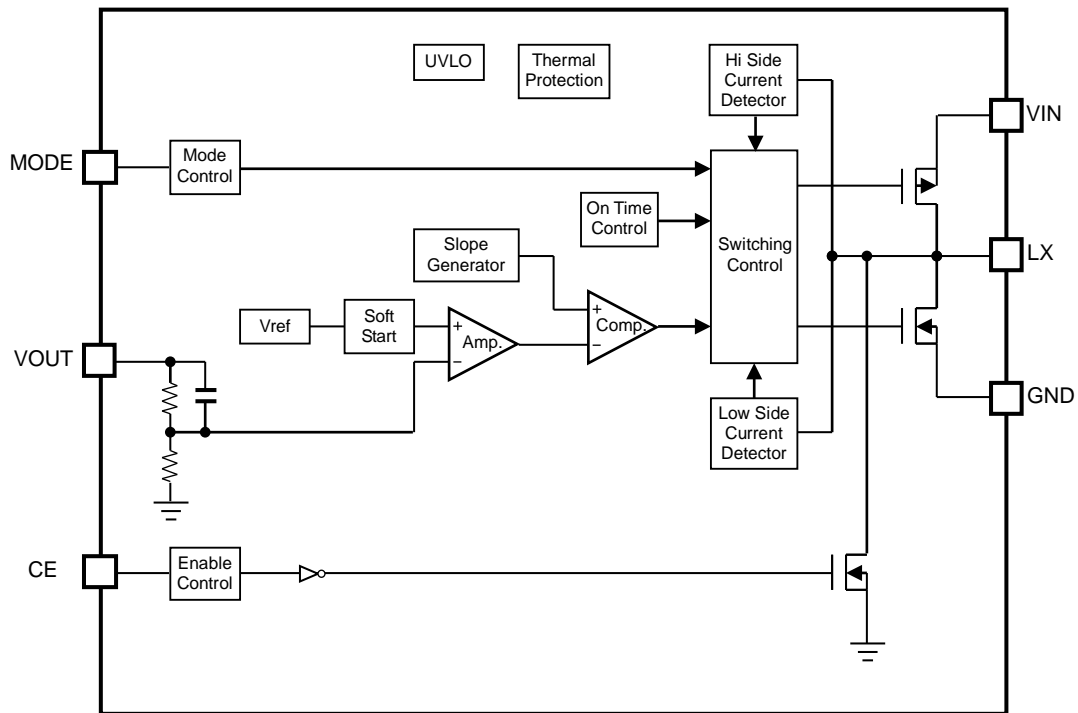

RP509xxxXB Block Diagram

**RP509x**

NO.EA-362-160510

**RP509ZxxXC/D, RP509NxxXC/D** *《under development》* (Adjustable Output Voltage Type)

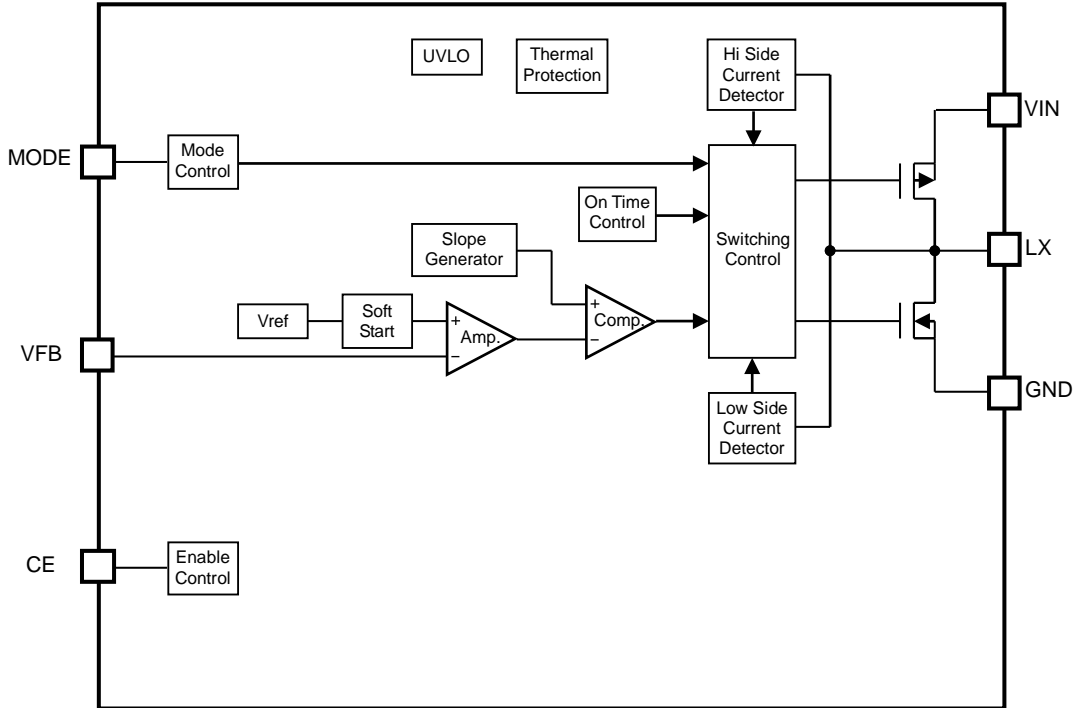

**RP509x00XC Block Diagram**

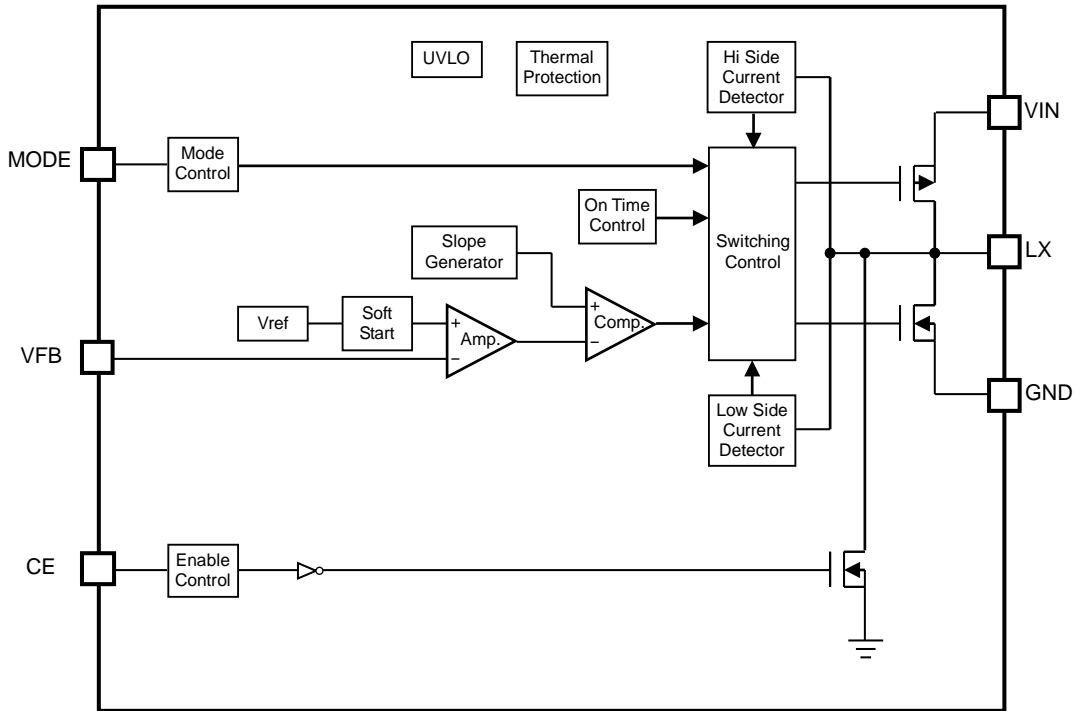

**RP509x00XD Block Diagram**

## PIN DESCRIPTION

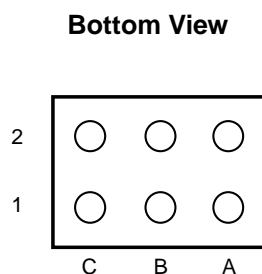
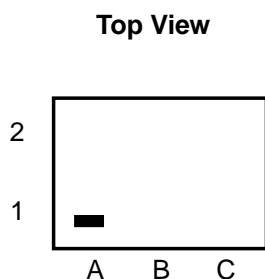

**WLCSP-6 Pin Configurations**

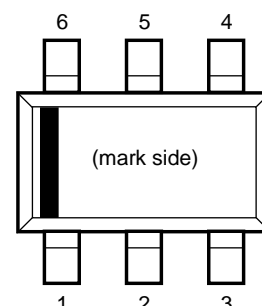

**SOT-23-6 Pin Configurations**

《under development》

### WLCSP-6 Pin Description

Pin No.	Symbol	Description
A1	MODE	Mode Control Pin ("H": forced PWM control, "L": PWM/VFM auto-switching control)
B1	LX	Switching Pin
C1	VOUT/ VFB	Output / Feedback Voltage Pin
A2	VIN	Input Voltage Pin
B2	CE	Chip Enable Pin (Active "H")
C2	GND	Ground Pin

### SOT-23-6 Pin Description 《under development》

Pin No.	Symbol	Description
1	CE	Chip Enable Pin (Active "H")
2	GND	Ground Pin
3	VIN	Input Voltage Pin
4	MODE	Mode Control Pin ("H": forced PWM control, "L": PWM/VFM auto-switching control)
5	LX	Switching Pin
6	VOUT/ VFB	Output / Feedback Voltage Pin

## RP509x

NO.EA-362-160510

## ABSOLUTE MAXIMUM RATINGS

### Absolute Maximum Ratings

(GND = 0 V)

Symbol	Item	Rating	Unit	
$V_{IN}$	Input Voltage	-0.3 to 6.5	V	
$V_{LX}$	LX Pin Voltage	-0.3 to $V_{IN} + 0.3$	V	
$V_{CE}$	CE Pin Voltage	-0.3 to 6.5	V	
$V_{MODE}$	MODE Pin Voltage	-0.3 to 6.5	V	
$V_{OUT}/V_{FB}$	VOUT/VFB Pin Voltage	-0.3 to 6.5	V	
$I_{LX}$	LX Pin Output Current	1.6	A	
$P_D$	Power Dissipation <sup>(1)</sup> (WLCSP6-P6)	JEDEC STD. 51-9 Test Land Pattern	910	mW
	Power Dissipation (SOT-23-6)		TBD	mW
$T_j$	Junction Temperature	-40 to 125	°C	
$T_{stg}$	Storage Temperature Range	-55 to 125	°C	

### ABSOLUTE MAXIMUM RATINGS

Electronic and mechanical stress momentarily exceeded absolute maximum ratings may cause the permanent damages and may degrade the lifetime and safety for both device and system using the device in the field. The functional operation at or over these absolute maximum ratings is not assured.

### RECOMMENDED OPERATING CONDITIONS

Symbol	Item	Rating	Unit
$V_{IN}$	Input Voltage	2.3 to 5.5	V
$T_a$	Operating Temperature Range	-40 to 85	°C

### RECOMMENDED OPERATING CONDITIONS

All of electronic equipment should be designed that the mounted semiconductor devices operate within the recommended operating conditions. The semiconductor devices cannot operate normally over the recommended operating conditions, even if when they are used over such conditions by momentary electronic noise or surge. And the semiconductor devices may receive serious damage when they continue to operate over the recommended operating conditions.

<sup>(1)</sup> Refer to *POWER DISSIPATION* for detailed information.

## ELECTRICAL CHARACTERISTICS

Test circuit is operated with "Open Loop Control" (GND = 0 V), unless otherwise specified.

RP509Zxx1A/B, RP509Nxx1A/B **《under development》** Electrical Characteristics (Ta = 25°C)

Symbol	Item	Conditions	Min.	Typ.	Max.	Unit	
V <sub>OUT</sub>	Output Voltage	V <sub>IN</sub> = V <sub>CE</sub> = 3.6 V (V <sub>SET</sub> ≤ 2.6 V), V <sub>IN</sub> = V <sub>CE</sub> = V <sub>SET</sub> + 1 V (V <sub>SET</sub> > 2.6 V)	V <sub>SET</sub> ≥ 1.2 V	x 0.985	x 1.015	V	
			V <sub>SET</sub> < 1.2 V	-0.018	+0.018		
ΔV <sub>OUT</sub> /ΔTa	Output Voltage Temperature Coefficient	-40 °C ≤ Ta ≤ 85 °C		±100		ppm/°C	
f <sub>OSC</sub>	Oscillator Frequency	V <sub>IN</sub> = V <sub>CE</sub> = 3.6 V, V <sub>SET</sub> = 1.8 V, "Closed Loop Control"	4.8	6.0	7.2	MHz	
I <sub>DD</sub>	Supply Current	V <sub>IN</sub> = V <sub>CE</sub> = V <sub>OUT</sub> = 3.6 V, V <sub>MODE</sub> = 0 V		15		μA	
I <sub>STANDBY</sub>	Standby Current	V <sub>IN</sub> = 5.5 V, V <sub>CE</sub> = 0 V		0	5	μA	
I <sub>CEH</sub>	CE "High" Input Current	V <sub>IN</sub> = V <sub>CE</sub> = 5.5 V	-1	0	1	μA	
I <sub>CEL</sub>	CE "Low" Input Current	V <sub>IN</sub> = 5.5 V, V <sub>CE</sub> = 0 V	-1	0	1	μA	
I <sub>MODEH</sub>	MODE "High" Input Current	V <sub>IN</sub> = V <sub>MODE</sub> = 5.5 V, V <sub>CE</sub> = 0 V	-1	0	1	μA	
I <sub>MODEL</sub>	MODE "Low" Input Current	V <sub>IN</sub> = 5.5 V, V <sub>CE</sub> = V <sub>MODE</sub> = 0 V	-1	0	1	μA	
I <sub>VOUTH</sub>	V <sub>OUT</sub> "High" Input Current	V <sub>IN</sub> = V <sub>OUT</sub> = 5.5 V, V <sub>CE</sub> = 0 V	-1	0	1	μA	
I <sub>VOUTL</sub>	V <sub>OUT</sub> "Low" Input Current	V <sub>IN</sub> = 5.5 V, V <sub>CE</sub> = V <sub>OUT</sub> = 0 V	-1	0	1	μA	
R <sub>DISTR</sub>	On-resistance for Auto Discharger <sup>(1)</sup>	V <sub>IN</sub> = 3.6 V, V <sub>CE</sub> = 0 V		40		Ω	
I <sub>LXLEAKH</sub>	LX "High" Leakage Current	V <sub>IN</sub> = V <sub>LX</sub> = 5.5 V, V <sub>CE</sub> = 0 V	-1	0	5	μA	
I <sub>LXLEAKL</sub>	LX "Low" Leakage Current	V <sub>IN</sub> = 5.5 V, V <sub>CE</sub> = V <sub>LX</sub> = 0 V	-5	0	1	μA	
V <sub>CEH</sub>	CE "High" Input Voltage	V <sub>IN</sub> = 5.5 V	1.0			V	
V <sub>CEL</sub>	CE "Low" Input Voltage	V <sub>IN</sub> = 2.3 V			0.4	V	
V <sub>MODEH</sub>	MODE "High" Input Voltage	V <sub>IN</sub> = V <sub>CE</sub> = 5.5 V	1.0			V	
V <sub>MODEL</sub>	MODE "Low" Input Voltage	V <sub>IN</sub> = V <sub>CE</sub> = 2.3 V			0.4	V	
R <sub>ONP</sub>	On-resistance of Pch. transistor	RP509Z	V <sub>IN</sub> = 3.6V, I <sub>LX</sub> = -100mA		0.175		Ω
		RP509N			TBD		Ω
R <sub>ONN</sub>	On-resistance of Nch. transistor	RP509Z	V <sub>IN</sub> = 3.6V, I <sub>LX</sub> = -100mA		0.155		Ω
		RP509N			TBD		Ω
Maxduty	Maximum Duty Cycle		100			%	
t <sub>START</sub>	Soft-start Time	V <sub>IN</sub> = V <sub>CE</sub> = 3.6 V (V <sub>SET</sub> ≤ 2.6 V), V <sub>IN</sub> = V <sub>CE</sub> = V <sub>SET</sub> + 1 V (V <sub>SET</sub> > 2.6 V)		150	300	μs	
I <sub>LXLIM</sub>	LX Current Limit	V <sub>IN</sub> = V <sub>CE</sub> = 3.6 V (V <sub>SET</sub> ≤ 2.6 V), V <sub>IN</sub> = V <sub>CE</sub> = V <sub>SET</sub> + 1 V (V <sub>SET</sub> > 2.6 V)	1200	1600		mA	
V <sub>UVLO1</sub>	UVLO Threshold Voltage	V <sub>IN</sub> = V <sub>CE</sub> , Falling	1.85	2.00	2.20	V	
V <sub>UVLO2</sub>		V <sub>IN</sub> = V <sub>CE</sub> , Rising	1.90	2.05	2.25	V	
T <sub>TSD</sub>	Thermal Shutdown Threshold Temperature	T <sub>j</sub> , Rising		140		°C	
T <sub>TSR</sub>		T <sub>j</sub> , Falling		100		°C	

All test items listed under Electrical Characteristics are done under the pulse load condition (T<sub>j</sub> ≈ Ta = 25°C).

<sup>(1)</sup> RP509xxx1B only

## RP509x

NO.EA-362-160510

Test circuit is operated with "Open Loop Control" (GND = 0 V), unless otherwise specified.

### RP509Z001C/D, RP509N001C/D **《under development》** Electrical Characteristics (Ta = 25°C)

Symbol	Item	Conditions	Min.	Typ.	Max.	Unit	
V <sub>FB</sub>	Feedback Voltage	V <sub>IN</sub> = V <sub>CE</sub> = 3.6 V	0.591	0.600	0.609	V	
ΔV <sub>FB</sub> /ΔTa	Feedback Voltage Temperature Coefficient	-40 °C ≤ Ta ≤ 85 °C		±100		ppm/°C	
f <sub>OSC</sub>	Oscillator Frequency	V <sub>IN</sub> = V <sub>CE</sub> = 3.6 V, V <sub>SET</sub> = 1.8 V, "Closed Loop Control"	4.8	6.0	7.2	MHz	
I <sub>DD</sub>	Supply Current	V <sub>IN</sub> = V <sub>CE</sub> = V <sub>OUT</sub> = 3.6V, V <sub>MODE</sub> = 0V		15		μA	
I <sub>STANDBY</sub>	Standby Current	V <sub>IN</sub> = 5.5 V, V <sub>CE</sub> = 0 V		0	5	μA	
I <sub>CEH</sub>	CE "High" Input Current	V <sub>IN</sub> = V <sub>CE</sub> = 5.5 V	-1	0	1	μA	
I <sub>CEL</sub>	CE "Low" Input Current	V <sub>IN</sub> = 5.5 V, V <sub>CE</sub> = 0 V	-1	0	1	μA	
I <sub>MODEH</sub>	MODE "High" Input Current	V <sub>IN</sub> = V <sub>MODE</sub> = 5.5 V, V <sub>CE</sub> = 0 V	-1	0	1	μA	
I <sub>MODEL</sub>	MODE "Low" Input Current	V <sub>IN</sub> = 5.5 V, V <sub>CE</sub> = V <sub>MODE</sub> = 0 V	-1	0	1	μA	
I <sub>VOUTH</sub>	V <sub>OUT</sub> "High" Input Current	V <sub>IN</sub> = V <sub>OUT</sub> = 5.5 V, V <sub>CE</sub> = 0 V	-1	0	1	μA	
I <sub>VOUTL</sub>	V <sub>OUT</sub> "Low" Input Current	V <sub>IN</sub> = 5.5 V, V <sub>CE</sub> = V <sub>OUT</sub> = 0 V	-1	0	1	μA	
R <sub>DISTR</sub>	On-resistance for Auto Discharge <sup>(1)</sup>	V <sub>IN</sub> = 3.6 V, V <sub>CE</sub> = 0 V		40		Ω	
I <sub>LXLEAKH</sub>	LX "High" Leakage Current	V <sub>IN</sub> = V <sub>LX</sub> = 5.5 V, V <sub>CE</sub> = 0 V	-1	0	5	μA	
I <sub>LXLEAKL</sub>	LX "Low" Leakage Current	V <sub>IN</sub> = 5.5 V, V <sub>CE</sub> = V <sub>LX</sub> = 0 V	-5	0	1	μA	
V <sub>CEH</sub>	CE "High" Input Voltage	V <sub>IN</sub> = 5.5 V	1.0			V	
V <sub>CEL</sub>	CE "Low" Input Voltage	V <sub>IN</sub> = 2.3 V			0.4	V	
V <sub>MODEH</sub>	MODE "High" Input Voltage	V <sub>IN</sub> = V <sub>CE</sub> = 5.5 V	1.0			V	
V <sub>MODEL</sub>	MODE "Low" Input Voltage	V <sub>IN</sub> = V <sub>CE</sub> = 2.3 V			0.4	V	
R <sub>ONP</sub>	On-resistance of Pch. Transistor	RP509Z	V <sub>IN</sub> = 3.6V, I <sub>LX</sub> = -100mA		0.175		Ω
		RP509N			TBD		Ω
R <sub>ONN</sub>	On-resistance of Nch. Transistor	RP509Z	V <sub>IN</sub> = 3.6V, I <sub>LX</sub> = -100mA		0.155		Ω
		RP509N			TBD		Ω
Maxduty	Maximum Duty Cycle		100			%	
t <sub>START</sub>	Soft-start Time	V <sub>IN</sub> = V <sub>CE</sub> = 3.6 V (V <sub>SET</sub> ≤ 2.6 V), V <sub>IN</sub> = V <sub>CE</sub> = V <sub>SET</sub> + 1 V (V <sub>SET</sub> > 2.6 V)		150	300	μs	
I <sub>LXLIM</sub>	LX Current Limit	V <sub>IN</sub> = V <sub>CE</sub> = 3.6 V (V <sub>SET</sub> ≤ 2.6 V), V <sub>IN</sub> = V <sub>CE</sub> = V <sub>SET</sub> + 1 V (V <sub>SET</sub> > 2.6 V)	1200	1600		mA	
V <sub>UVLO1</sub>	UVLO Threshold Voltage	V <sub>IN</sub> = V <sub>CE</sub> , Falling	1.85	2.00	2.20	V	
V <sub>UVLO2</sub>		V <sub>IN</sub> = V <sub>CE</sub> , Rising	1.90	2.05	2.25	V	
T <sub>TSD</sub>	Thermal Shutdown Threshold Temperature	T <sub>j</sub> , Rising		140		°C	
T <sub>TSR</sub>		T <sub>j</sub> , Falling		100		°C	

All test items listed under Electrical Characteristics are done under the pulse load condition (T<sub>j</sub> ≈ Ta = 25°C).

<sup>(1)</sup> RP509x001D only



Test circuit is operated with "Open Loop Control" (GND = 0 V), unless otherwise specified.

RP509Zxx2A/B, RP509Nxx2A/B **《under development》** Electrical Characteristics (Ta = 25°C)

Symbol	Item	Conditions	Min.	Typ.	Max.	Unit	
V <sub>OUT</sub>	Output Voltage	V <sub>IN</sub> = V <sub>CE</sub> = 3.6 V (V <sub>SET</sub> ≤ 2.6 V), V <sub>IN</sub> = V <sub>CE</sub> = V <sub>SET</sub> + 1 V (V <sub>SET</sub> > 2.6 V)	V <sub>SET</sub> ≥ 1.2 V	x 0.985	x 1.015	V	
			V <sub>SET</sub> < 1.2 V	-0.018	+0.018		
ΔV <sub>OUT</sub> /ΔTa	Output Voltage Temperature Coefficient	-40 °C ≤ Ta ≤ 85 °C			±100	ppm/°C	
f <sub>OSC</sub>	Oscillator Frequency	V <sub>IN</sub> = V <sub>CE</sub> = 3.6 V, V <sub>SET</sub> = 1.8 V, "Closed Loop Control"		4.8	6.0	7.2	MHz
I <sub>DD</sub>	Supply Current	V <sub>IN</sub> = V <sub>CE</sub> = V <sub>OUT</sub> = 3.6V, V <sub>MODE</sub> = 0V			15		μA
I <sub>STANDBY</sub>	Standby Current	V <sub>IN</sub> = 5.5 V, V <sub>CE</sub> = 0 V			0	5	μA
I <sub>CEH</sub>	CE "High" Input Current	V <sub>IN</sub> = V <sub>CE</sub> = 5.5 V		-1	0	1	μA
I <sub>CEL</sub>	CE "Low" Input Current	V <sub>IN</sub> = 5.5 V, V <sub>CE</sub> = 0 V		-1	0	1	μA
I <sub>MODEH</sub>	MODE "High" Input Current	V <sub>IN</sub> = V <sub>MODE</sub> = 5.5 V, V <sub>CE</sub> = 0 V		-1	0	1	μA
I <sub>MODEL</sub>	MODE "Low" Input Current	V <sub>IN</sub> = 5.5 V, V <sub>CE</sub> = V <sub>MODE</sub> = 0 V		-1	0	1	μA
I <sub>VOUTH</sub>	V <sub>OUT</sub> "High" Input Current	V <sub>IN</sub> = V <sub>OUT</sub> = 5.5 V, V <sub>CE</sub> = 0 V		-1	0	1	μA
I <sub>VOUTL</sub>	V <sub>OUT</sub> "Low" Input Current	V <sub>IN</sub> = 5.5 V, V <sub>CE</sub> = V <sub>OUT</sub> = 0 V		-1	0	1	μA
R <sub>DISTR</sub>	On-resistance for Auto Discharger <sup>(1)</sup>	V <sub>IN</sub> = 3.6 V, V <sub>CE</sub> = 0 V			40		Ω
I <sub>LXLEAKH</sub>	LX "High" Leakage Current	V <sub>IN</sub> = V <sub>LX</sub> = 5.5 V, V <sub>CE</sub> = 0 V		-1	0	5	μA
I <sub>LXLEAKL</sub>	LX "Low" Leakage Current	V <sub>IN</sub> = 5.5 V, V <sub>CE</sub> = V <sub>LX</sub> = 0 V		-5	0	1	μA
V <sub>CEH</sub>	CE "High" Input Voltage	V <sub>IN</sub> = 5.5 V		1.0			V
V <sub>CEL</sub>	CE "Low" Input Voltage	V <sub>IN</sub> = 2.3 V				0.4	V
V <sub>MODEH</sub>	MODE "High" Input Voltage	V <sub>IN</sub> = V <sub>CE</sub> = 5.5 V		1.0			V
V <sub>MODEL</sub>	MODE "Low" Input Voltage	V <sub>IN</sub> = V <sub>CE</sub> = 2.3 V				0.4	V
R <sub>ONP</sub>	On-resistance of Pch. transistor	RP509Z	V <sub>IN</sub> = 3.6V, I <sub>LX</sub> = -100mA		0.175		Ω
		RP509N			TBD		Ω
R <sub>ONN</sub>	On-resistance of Nch. transistor	RP509Z	V <sub>IN</sub> = 3.6V, I <sub>LX</sub> = -100mA		0.155		Ω
		RP509N			TBD		Ω
Maxduty	Maximum Duty Cycle			100			%
t <sub>START</sub>	Soft-start Time	V <sub>IN</sub> = V <sub>CE</sub> = 3.6 V (V <sub>SET</sub> ≤ 2.6 V), V <sub>IN</sub> = V <sub>CE</sub> = V <sub>SET</sub> + 1 V (V <sub>SET</sub> > 2.6 V)			150	300	μs
I <sub>LXLIM</sub>	LX Current Limit	V <sub>IN</sub> = V <sub>CE</sub> = 3.6 V (V <sub>SET</sub> ≤ 2.6 V), V <sub>IN</sub> = V <sub>CE</sub> = V <sub>SET</sub> + 1 V (V <sub>SET</sub> > 2.6 V)		600	1000		mA
V <sub>UVLO1</sub>	UVLO Threshold Voltage	V <sub>IN</sub> = V <sub>CE</sub> , Falling		1.85	2.00	2.20	V
V <sub>UVLO2</sub>		V <sub>IN</sub> = V <sub>CE</sub> , Rising		1.90	2.05	2.25	V
T <sub>TSD</sub>	Thermal Shutdown Threshold Temperature	T <sub>j</sub> , Rising			140		°C
T <sub>TSR</sub>		T <sub>j</sub> , Falling			100		°C

All test items listed under Electrical Characteristics are done under the pulse load condition (T<sub>j</sub> ≈ Ta = 25°C).

<sup>(1)</sup> RP509xxx2B only

## RP509x

NO.EA-362-160510

Test circuit is operated with "Open Loop Control" (GND = 0 V), unless otherwise specified.

### RP509Z002C/D, RP509N002C/D **《under development》** Electrical Characteristics (Ta = 25°C)

Symbol	Item	Conditions	Min.	Typ.	Max.	Unit
V <sub>FB</sub>	Feedback Voltage	V <sub>IN</sub> = V <sub>CE</sub> = 3.6 V	0.591	0.600	0.609	V
$\frac{\Delta V_{FB}}{\Delta T_a}$	Feedback Voltage Temperature Coefficient	-40 °C ≤ Ta ≤ 85 °C		±100		ppm/°C
f <sub>OSC</sub>	Oscillator Frequency	V <sub>IN</sub> = V <sub>CE</sub> = 3.6 V, V <sub>SET</sub> = 1.8 V, "Closed Loop Control"	4.8	6.0	7.2	MHz
I <sub>DD</sub>	Supply Current	V <sub>IN</sub> = V <sub>CE</sub> = V <sub>OUT</sub> = 3.6V, V <sub>MODE</sub> = 0V		15		μA
I <sub>STANDBY</sub>	Standby Current	V <sub>IN</sub> = 5.5 V, V <sub>CE</sub> = 0 V		0	5	μA
I <sub>CEH</sub>	CE "High" Input Current	V <sub>IN</sub> = V <sub>CE</sub> = 5.5 V	-1	0	1	μA
I <sub>CEL</sub>	CE "Low" Input Current	V <sub>IN</sub> = 5.5 V, V <sub>CE</sub> = 0 V	-1	0	1	μA
I <sub>MODEH</sub>	MODE "High" Input Current	V <sub>IN</sub> = V <sub>MODE</sub> = 5.5 V, V <sub>CE</sub> = 0 V	-1	0	1	μA
I <sub>MODEL</sub>	MODE "Low" Input Current	V <sub>IN</sub> = 5.5 V, V <sub>CE</sub> = V <sub>MODE</sub> = 0 V	-1	0	1	μA
I <sub>VOUTH</sub>	V <sub>OUT</sub> "High" Input Current	V <sub>IN</sub> = V <sub>OUT</sub> = 5.5 V, V <sub>CE</sub> = 0 V	-1	0	1	μA
I <sub>VOU TL</sub>	V <sub>OUT</sub> "Low" Input Current	V <sub>IN</sub> = 5.5 V, V <sub>CE</sub> = V <sub>OUT</sub> = 0 V	-1	0	1	μA
R <sub>DISTR</sub>	On-resistance for Auto Discharge <sup>(1)</sup>	V <sub>IN</sub> = 3.6 V, V <sub>CE</sub> = 0 V		40		Ω
I <sub>LXLEAKH</sub>	LX "High" Leakage Current	V <sub>IN</sub> = V <sub>LX</sub> = 5.5 V, V <sub>CE</sub> = 0 V	-1	0	5	μA
I <sub>LXLEAKL</sub>	LX "Low" Leakage Current	V <sub>IN</sub> = 5.5 V, V <sub>CE</sub> = V <sub>LX</sub> = 0 V	-5	0	1	μA
V <sub>CEH</sub>	CE "High" Input Voltage	V <sub>IN</sub> = 5.5 V	1.0			V
V <sub>CEL</sub>	CE "Low" Input Voltage	V <sub>IN</sub> = 2.3 V			0.4	V
V <sub>MODEH</sub>	MODE "High" Input Voltage	V <sub>IN</sub> = V <sub>CE</sub> = 5.5 V	1.0			V
V <sub>MODEL</sub>	MODE "Low" Input Voltage	V <sub>IN</sub> = V <sub>CE</sub> = 2.3 V			0.4	V
R <sub>ONP</sub>	On-resistance of Pch. Transistor	RP509Z	V <sub>IN</sub> = 3.6V, I <sub>LX</sub> = -100mA		0.175	Ω
		RP509N			TBD	Ω
R <sub>ONN</sub>	On-resistance of Nch. Transistor	RP509Z	V <sub>IN</sub> = 3.6V, I <sub>LX</sub> = -100mA		0.155	Ω
		RP509N			TBD	Ω
Maxduty	Maximum Duty Cycle		100			%
t <sub>START</sub>	Soft-start Time	V <sub>IN</sub> = V <sub>CE</sub> = 3.6 V (V <sub>SET</sub> ≤ 2.6 V), V <sub>IN</sub> = V <sub>CE</sub> = V <sub>SET</sub> + 1 V (V <sub>SET</sub> > 2.6 V)		150	300	μs
I <sub>LXLIM</sub>	LX Current Limit	V <sub>IN</sub> = V <sub>CE</sub> = 3.6 V (V <sub>SET</sub> ≤ 2.6 V), V <sub>IN</sub> = V <sub>CE</sub> = V <sub>SET</sub> + 1 V (V <sub>SET</sub> > 2.6 V)	600	1000		mA
V <sub>UVLO1</sub>	UVLO Threshold Voltage	V <sub>IN</sub> = V <sub>CE</sub> , Falling	1.85	2.00	2.20	V
V <sub>UVLO2</sub>		V <sub>IN</sub> = V <sub>CE</sub> , Rising	1.90	2.05	2.25	V
T <sub>TSD</sub>	Thermal Shutdown	T <sub>j</sub> , Rising		140		°C
T <sub>TSR</sub>	Threshold Temperature	T <sub>j</sub> , Falling		100		°C

All test items listed under Electrical Characteristics are done under the pulse load condition (T<sub>j</sub> ≈ Ta = 25°C).

<sup>(1)</sup> RP509x002D only

**Electrical Characteristics by Different Output Voltage**
**RP509ZxxXA/B, RP509NxxXA/B 《under development》 (Fixed Output Voltage Type) (Ta = 25°C)**

Product Name	V <sub>OUT</sub> [V] (Ta = 25°C)		
	Min.	Typ.	Max.
RP509x06XA/B	0.582	0.600	0.618
RP509x07XA/B	0.682	0.700	0.718
RP509x08XA/B	0.782	0.800	0.818
RP509x09XA/B	0.882	0.900	0.918
RP509x10XA/B	0.982	1.000	1.018
RP509x11XA/B	1.082	1.100	1.118
RP509x12XA/B	1.182	1.200	1.218
RP509x13XA/B	1.281	1.300	1.319
RP509x14XA/B	1.379	1.400	1.421
RP509x15XA/B	1.478	1.500	1.522
RP509x16XA/B	1.576	1.600	1.624
RP509x17XA/B	1.675	1.700	1.725
RP509x18XA/B	1.773	1.800	1.827
RP509x19XA/B	1.872	1.900	1.928
RP509x20XA/B	1.970	2.000	2.030
RP509x21XA/B	2.069	2.100	2.131
RP509x22XA/B	2.167	2.200	2.233
RP509x23XA/B	2.266	2.300	2.334
RP509x24XA/B	2.364	2.400	2.436
RP509x25XA/B	2.463	2.500	2.537
RP509x26XA/B	2.561	2.600	2.639
RP509x27XA/B	2.660	2.700	2.740
RP509x28XA/B	2.758	2.800	2.842
RP509x29XA/B	2.857	2.900	2.943
RP509x30XA/B	2.955	3.000	3.045
RP509x31XA/B	3.054	3.100	3.146
RP509x32XA/B	3.152	3.200	3.248
RP509x33XA/B	3.251	3.300	3.349

## OPERATING DESCRIPTIONS

### Soft-start Time

#### Starting-up with CE Pin

The IC starts to operate when the CE pin voltage ( $V_{CE}$ ) exceeds the threshold voltage. The threshold voltage is preset between CE "H" input voltage ( $V_{CEH}$ ) and CE "L" input voltage ( $V_{CEL}$ ).

After the start-of the start-up of the IC, soft-start circuit starts to operate. Then, after a certain period of time, the reference voltage ( $V_{REF}$ ) in the IC gradually increases up to the specified value.

Notes: Soft start time ( $t_{START}$ )<sup>(1)</sup> is not always equal to the turn-on speed of the step-down DC/DC converter. Please note that the turn-on speed could be affected by the power supply capacity, the output current, the inductance value and the  $C_{OUT}$  value.

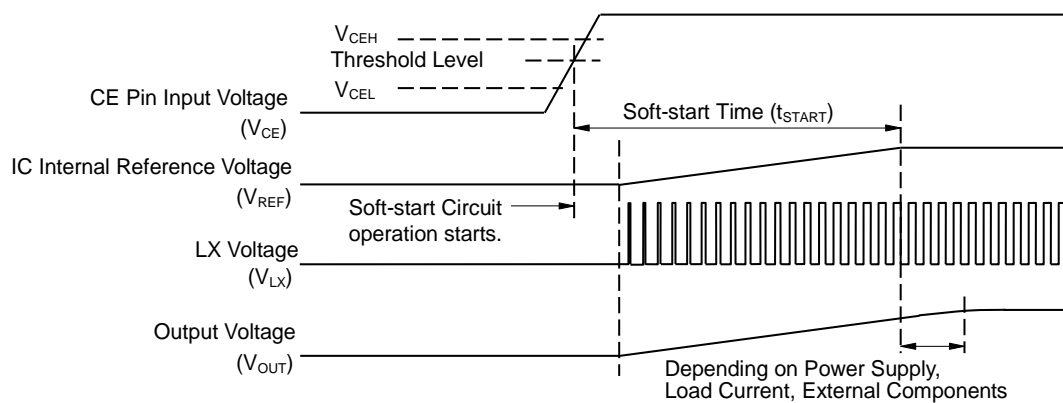

**Timing Chart when Starting-up with CE Pin**

---

<sup>(1)</sup> Soft-start time ( $t_{START}$ ) indicates the duration until the reference voltage ( $V_{REF}$ ) reaches the specified voltage after soft-start circuit's activation.

---

**Starting-up with Power Supply**

After the power-on, when  $V_{IN}$  exceeds the UVLO released voltage ( $V_{UVLO2}$ ), the IC starts to operate. Then, soft-start circuit starts to operate and after a certain period of time,  $V_{REF}$  gradually increases up to the specified value.

Notes: Please note that the turn-on speed of  $V_{OUT}$  could be affected by the power supply capacity, the output current, the inductance value, the  $C_{OUT}$  value and the turn-on speed of  $V_{IN}$  determined by  $C_{IN}$ .

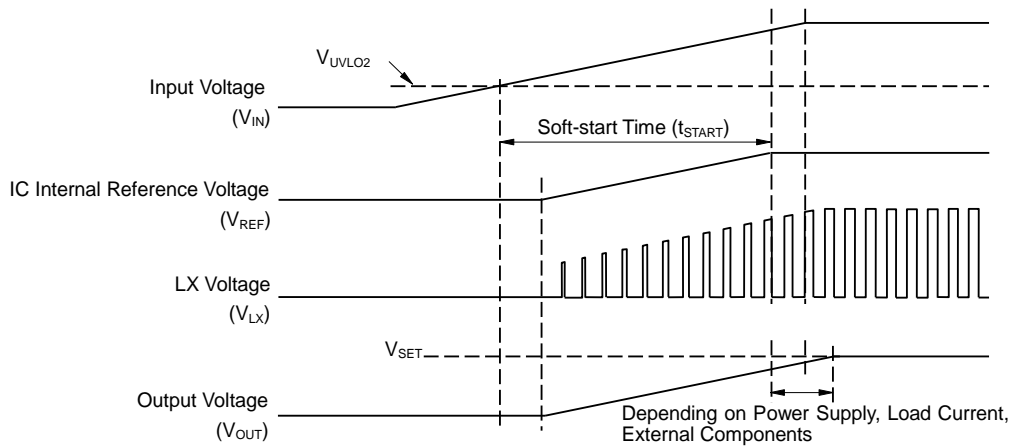

**Timing Chart when Starting-up with Power Supply**

**Under Voltage Lockout (UVLO) Circuit**

If  $V_{IN}$  becomes lower than  $V_{SET}$ , the step-down DC/DC converter stops the switching operation and ON duty becomes 100%, and then  $V_{OUT}$  gradually drops according to  $V_{IN}$ .

If the  $V_{IN}$  drops more and becomes lower than the UVLO detector threshold ( $V_{UVLO1}$ ), the UVLO circuit starts to operate,  $V_{REF}$  stops, and Pch. and Nch. built-in switch transistors turn "OFF". As a result,  $V_{OUT}$  drops according to the  $C_{OUT}$  capacitance value and the load.

To restart the operation,  $V_{IN}$  needs to be higher than  $V_{UVLO2}$ . The timing chart below shows the voltage shifts of  $V_{REF}$ ,  $V_{LX}$  and  $V_{OUT}$  when  $V_{IN}$  value is varied.

Notes: Falling edge (operating) and rising edge (releasing) waveforms of  $V_{OUT}$  could be affected by the initial voltage of  $C_{OUT}$  and the output current of  $V_{OUT}$ .

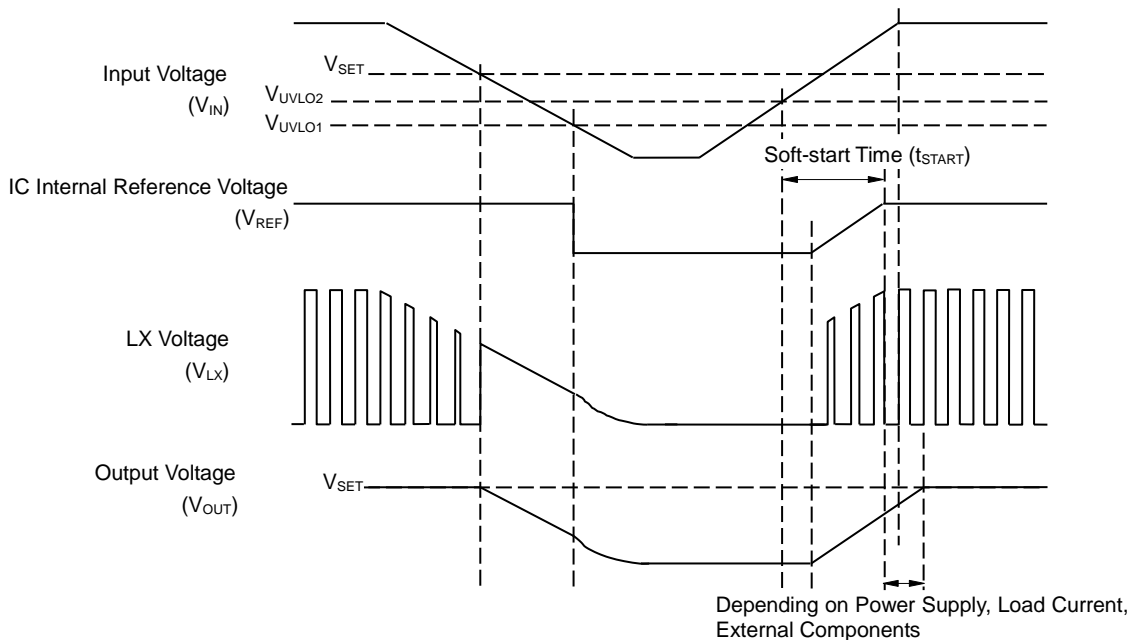
**Timing Chart with Variations in Input Voltage ( $V_{IN}$ )**

**Current limit Circuit**

Current limit circuit supervises the inductor peak current (the peak current flowing through Pch. Tr.) in each switching cycle, and if the current exceeds the LX current limit ( $I_{LXLIM}$ ), it turns off Pch. Tr.  $I_{LXLIM}$  of the RP509x is set to Typ.1.6 A or Typ.1.0 A.

Notes:  $I_{LXLIM}$  could be easily affected by self-heating or ambient environment. If the  $V_{IN}$  drops dramatically or becomes unstable due to short-circuit, protection operation could be affected.

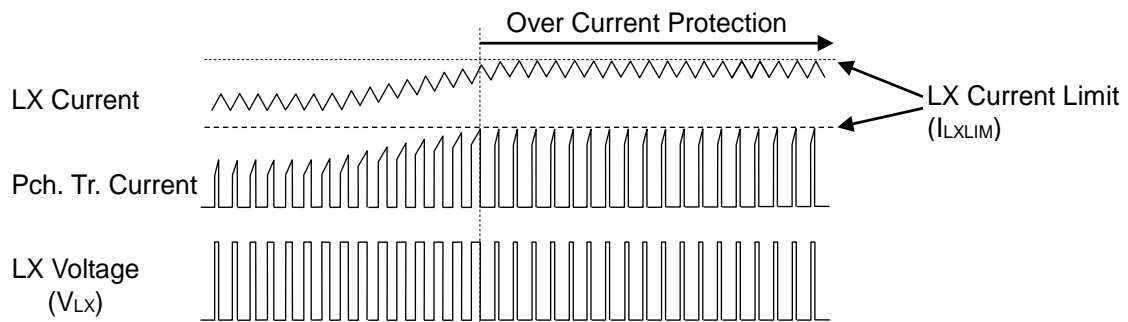
**Over-Current Protection Operation**

**Operation of Step-down DC/DC Converter and Output Current**

The step-down DC/DC converter charges energy in the inductor when LX Tr. turns “ON”, and discharges the energy from the inductor when LX Tr. turns “OFF” and controls with less energy loss, so that a lower output voltage ( $V_{OUT}$ ) than the input voltage ( $V_{IN}$ ) can be obtained. The operation of the step-down DC/DC converter is explained in the following figures.

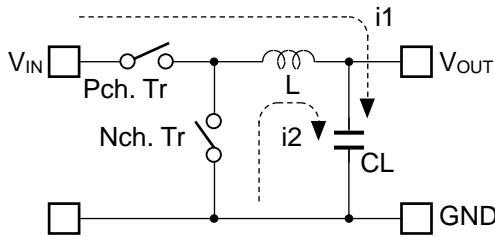

**Basic Circuit**

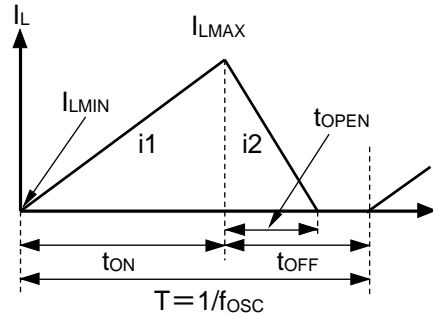

**Inductor Current ( $I_L$ ) flowing through Inductor (L)**

- Step1.** Pch. Tr. turns “ON” and  $I_L$  ( $i1$ ) flows, L is charged with energy. At this moment,  $i1$  increases from the minimum inductor current ( $I_{LMIN}$ ), which is 0 A, and reaches the maximum inductor current ( $I_{LMAX}$ ) in proportion to the on-time period ( $t_{ON}$ ) of Pch. Tr.
- Step2.** When Pch. Tr. turns “OFF”, L tries to maintain  $I_L$  at  $I_{LMAX}$ , so L turns Nch Tr. “ON” and  $I_L$  ( $i2$ ) flows into L.
- Step3.**  $i2$  decreases gradually and reaches  $I_{LMIN}$  after the open-time period ( $t_{OPEN}$ ) of Nch. Tr., and then Nch. Tr. turns “OFF”. This is called discontinuous current mode.  
As the output current ( $I_{OUT}$ ) increases, the off-time period ( $t_{OFF}$ ) of Pch. Tr. runs out before  $I_L$  reaches  $I_{LMIN}$ . The next cycle starts, and Pch. Tr. turns “ON” and Nch. Tr. turns “OFF”, which means  $I_L$  starts increasing from  $I_{LMIN}$ . This is called continuous current mode.

In PWM mode,  $V_{OUT}$  is maintained by controlling  $t_{on}$ . The oscillator frequency ( $f_{osc}$ ) is maintained constant during PWM mode.

When the step-down DC/DC operation is constant,  $I_{LMIN}$  and  $I_{LMAX}$  during  $t_{on}$  of Pch. Tr. would be same as during  $t_{OFF}$  of Pch. Tr. The current differential between  $I_{LMAX}$  and  $I_{LMIN}$  is described as  $\Delta I$ , as the following equation 1.

$$\Delta I = I_{LMAX} - I_{LMIN} = V_{OUT} \times t_{OPEN} / L = (V_{IN} - V_{OUT}) \times t_{ON} / L \dots\dots\dots \text{Equation 1}$$

The above equation is predicated on the following requirements.

- $T = 1 / f_{OSC} = t_{ON} + t_{OFF}$
- duty (%) =  $t_{ON} / T \times 100 = t_{ON} \times f_{OSC} \times 100$
- $t_{OPEN} \leq t_{OFF}$

In Equation 1, “ $V_{OUT} \times t_{OPEN} / L$ ” shows the amount of current change in “OFF” state. Also, “ $(V_{IN} - V_{OUT}) \times t_{ON} / L$ ” shows the amount of current change at “ON” state.



**Discontinuous Mode and Continuous Mode**

As illustrated in Figure A., when  $I_{OUT}$  is relatively small,  $t_{OPEN} < t_{OFF}$ . In this case, the energy charged into L during  $t_{ON}$  will be completely discharged during  $t_{OFF}$ , as a result,  $I_{LMIN} = 0$ . This is called discontinuous mode. When  $I_{OUT}$  is gradually increased, eventually  $t_{OPEN} = t_{OFF}$  and when  $I_{OUT}$  is increased further, eventually  $I_{LMIN} > 0$  as illustrated in Figure B. This is called continuous mode.

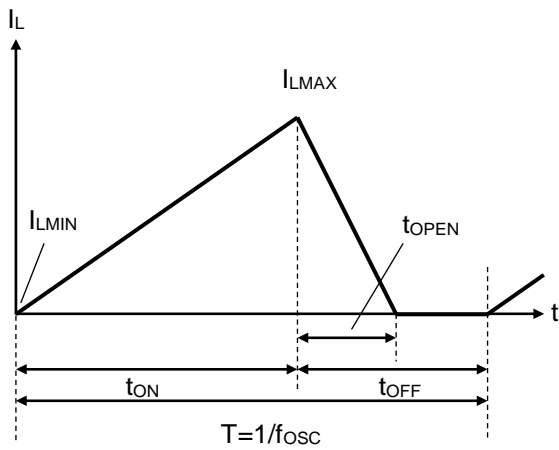

**Figure A. Discontinuous Mode**

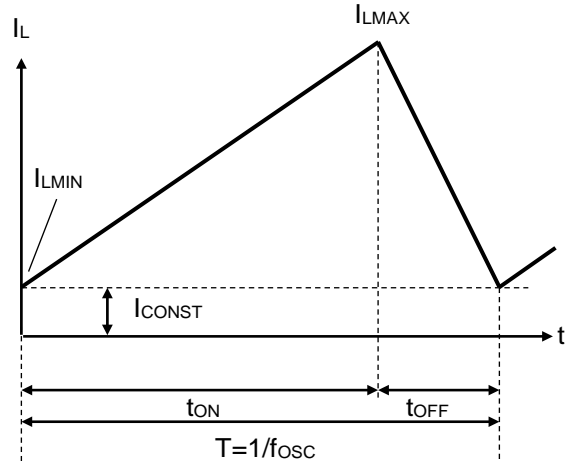

**Figure B. Continuous Mode**

In the continuous mode, the solution of Equation 1 is described as  $t_{ONC}$ .

$$t_{ONC} = T \times V_{OUT} / V_{IN} \dots\dots\dots \text{Equation 2}$$

When  $t_{ON} < t_{ONC}$ , it is discontinuous mode, and when  $t_{ON} = t_{ONC}$ , it is continuous mode.

**Forced PWM Mode and VFM Mode**

Output voltage controlling method is selectable between a forced PWM control type and a PWM/VFM auto-switching control type, and can be set by the MODE pin. The forced PWM control switches at fixed frequency rate in order to reduce noise in low output current. The PWM/VFM auto-switching control automatically switches from PWM mode to VFM mode in order to achieve high efficiency in low output current.

**Forced PWM Mode**

By setting the MODE pin to "H", the IC switches the frequency at the fixed rate to reduce noise even when the output load is light. Therefore, when  $I_{OUT}$  is  $\Delta I_L/2$  or less,  $I_{LMIN}$  becomes less than "0". That is, the accumulated electricity in CL is discharged through the IC side while  $I_L$  is increasing from  $I_{LMIN}$  to "0" during  $t_{ON}$ , and also while  $I_L$  is decreasing from "0" to  $I_{LMIN}$  during  $t_{OFF}$ .

**VFM Mode**

By setting the MODE pin to "L", in low output current, the IC automatically switches into VFM mode in order to achieve high efficiency. In VFM mode,  $t_{ON}$  is determined depending on  $V_{IN}$  and  $V_{OUT}$ .

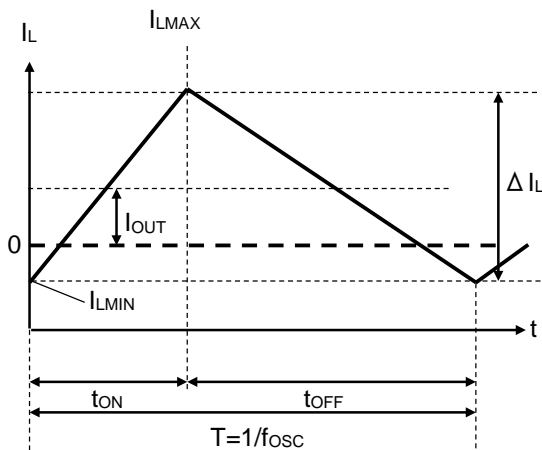
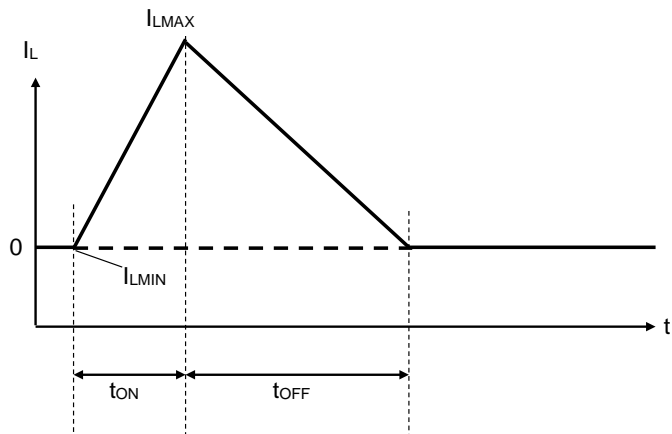
**Forced PWM Mode****VFM Mode**

## APPLICATION INFORMATION

### Application Circuits

MODE = "H": forced PWM control, MODE = "L": PWM/VFM auto-switching control

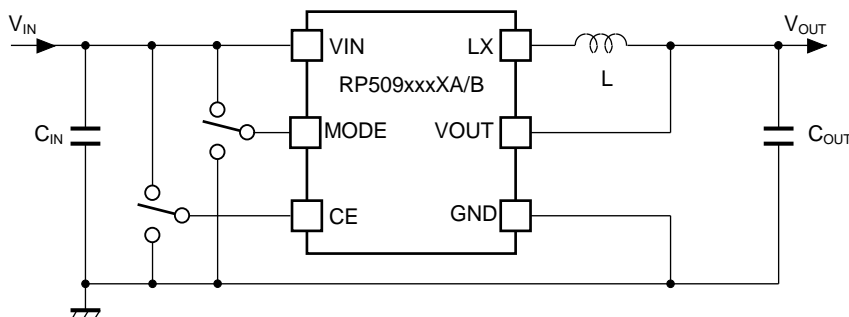

RP509xxxXA/B (Fixed Output Voltage Type)

MODE = "H": forced PWM control, MODE = "L": PWM/VFM auto-switching control

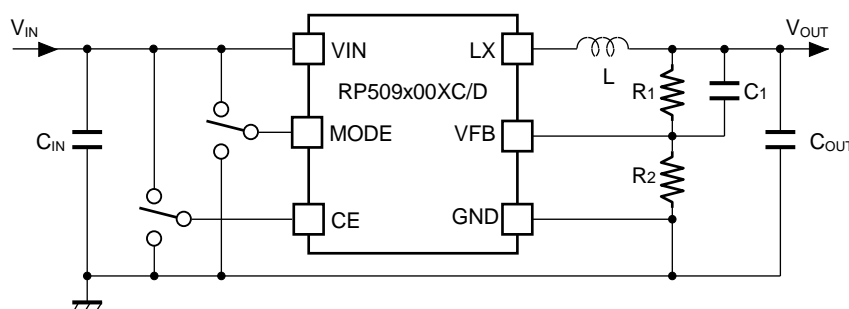

RP509x00XC/D (Adjustable Output Voltage Type)

### Recommended External Components

Symbol	Descriptions
$C_{IN}$	4.7 $\mu$ F and more, Ceramic Capacitor, See the table of "Input Voltage vs. Capacitance" in the following page.
$C_{OUT}$	10 $\mu$ F, Ceramic Capacitor, See the table of "Set Output Voltage ( $V_{SET}$ ) vs. Capacitance" in the following page.
L	0.47 $\mu$ H to 0.56 $\mu$ H, See the table of "Inductance Range vs. PWM Frequency" in the following page.

**RP509x**

NO.EA-362-160510

**Input Voltage vs. Capacitance**

$V_{IN}$ [V]	Size [mm]	$C_{IN}$ [ $\mu$ F]	Rated Voltage [V]	Model
Up to 4.5	1005	4.7	6.3	JMK105BBJ475MV (Taiyo Yuden)
		10	6.3	C1005X5R0J106M050BC (TDK)
	1608	4.7	6.3	GRM188R60J475ME84 (Murata) GRM188R60J475ME19 (Murata) C1608X5R0J475M080AB (TDK) JMK107BJ475MA (Taiyo Yuden)
		10	6.3	GRM188R60J106ME47 (Murata) C1608X5R0J106M080AB (TDK) JMK107ABJ106MA (Taiyo Yuden)
Up to 5.5	1005	10	6.3	C1005X5R0J106M050BC (TDK)
	1608	4.7	6.3	GRM188R60J475ME84 (Murata) GRM188R60J475ME19 (Murata) JMK107BJ475MA (Taiyo Yuden)
		10	6.3	GRM188R60J106ME47 (Murata) C1608X5R0J106M080AB (TDK) JMK107ABJ106MA (Taiyo Yuden)

**Set Output Voltage ( $V_{SET}$ ) vs. Capacitance**

Version	$V_{SET}$ [V]	Size [mm]	$C_{OUT}$ [ $\mu$ F]	Rated Voltage [V]	Model
RP509xxxXA/B or RP509x00X/C/D	0.6 to 1.8	1005	10	4	GRM155R60G106ME44 (Murata) C1005X5R0G106M050BB (TDK) AMK105CBJ106MV (Taiyo Yuden)
			10	6.3	C1005X5R0J106M050BC (TDK)
		1608	10	6.3	GRM188R60J106ME47 (Murata) C1608X5R0J106M080AB (TDK) JMK107ABJ106MA (Taiyo Yuden)
			1005	10	4
	1.9 to 3.3	1608		10	6.3
			10	6.3	GRM188R60J106ME47 (Murata) C1608X5R0J106M080AB (TDK) JMK107ABJ106MA (Taiyo Yuden)
RP509x00XC/D	3.4 to 4.5	1608	10	6.3	GRM188R60J106ME47 (Murata) C1608X5R0J106M080AB (TDK) JMK107ABJ106MA (Taiyo Yuden)

**Inductance Range vs. PWM Frequency**

Version	PWM Frequency [MHz]	Size [mm]	Height(Max) [mm]	L [μH]	Rdc(Typ) [mΩ]	Model
RP509xxxXA/B or RP509x00XC/D	6.0	1608	0.95	0.47	110	MDT1608-CHR47M (TOKO)
					90	MDT1608-CRR47M (TOKO)
		2012	1.0	0.5	60	MIPSZ2012D0R5 (FDK)
				0.56	65	MDT2012-CRR56N (TOKO)
				0.47	70	MLP2012HR47MT (TDK)
				0.54	65	MLP2012HR54MT (TDK)
				0.47	60	CKP2012NR47M-T (Taiyo Yuden)
				0.47	48	BRL2012TR47M6 (Taiyo Yuden)
				0.47	75	LQM21PNR47MG0 (Murata)

**Cautions in selecting external parts**

- Choose a low ESR ceramic capacitor. The capacitance of  $C_{IN}$  between  $V_{IN}$  and GND should be more than or equal to 4.7 μF. The capacitance of a ceramic capacitor ( $C_{OUT}$ ) should be 10 μF. Also, choose the capacitor with consideration for bias characteristics and input/output voltages. See the above tables of “Input Voltage vs. Capacitance” and “Set Output Voltage vs. Capacitance”.
- The phase compensation of this device is designed according to the  $C_{OUT}$  and L values. The inductance range of an inductor should be between 0.47μH to 0.56 μH in order to gain stability. See the above table of “Inductance Range vs. PWM Frequency”.
- Choose an inductor that has small DC resistance, has enough permissible current and is hard to cause magnetic saturation. If the inductance value of the inductor becomes extremely small under the load conditions, the peak current of LX may increase along with the load current. As a result, over current protection circuit may start to operate when the peak current of LX reaches to LX limit current. Therefore, choose an inductor with consideration for the value of  $I_{LXMAX}$ . See the following page of “Calculation Conditions of LX Pin Maximum Output Current ( $I_{LXMAX}$ )”.
- As for the fixed output voltage type (RP509x00XC/D), Output Voltage ( $V_{SET}$ ) is settable by changing values of R1 and R2.  $V_{SET}$  is given by the following expression.
- As for the adjustable output voltage type, the set output voltage ( $V_{SET}$ ) is adjustable by changing the resistance values of resistors (R1, R2) as follows. See the following table for each recommended value of R1, R2 and C1.

$$V_{SET} = V_{FB} \times (R1 + R2) / R2$$

---

**RP509x**

---

NO.EA-362-160510

**Set Output Voltage ( $V_{SET}$ ) vs. R1 / R2 / C1 (Adjustable Output Voltage Type)**

$V_{SET}$ [V]	R1 [k $\Omega$ ]	R2 [k $\Omega$ ]	C1 [pF]
0.6	0	220	Open
$0.6 < V_{SET} \leq 0.9$	$R1 = (V_{SET} / V_{FB} - 1) \times R2$	220	47
$0.9 < V_{SET} \leq 1.8$		220	33
$1.8 < V_{SET} \leq 2.1$		150	10
$2.1 < V_{SET} \leq 2.4$		100	10
$2.4 < V_{SET} \leq 2.7$		68	10
$2.7 < V_{SET} \leq 3.0$		47	10
$3.0 < V_{SET} \leq V_{IN}$		47	6.8

**Calculation Conditions of LX Pin Maximum Output Current ( $I_{LXMAX}$ )**

The following equations explain the relationship to determine  $I_{LXMAX}$  at the ideal operation of the ICs in continuous mode.

Ripple Current P-P value is described as  $I_{RP}$ , ON resistance of Pch. Tr. is described as  $R_{ONP}$ , ON resistance of Nch. Tr. is described as  $R_{ONN}$ , and DC resistor of the inductor is described as  $R_L$ .

First, when Pch. Tr. is "ON", Equation 1 is satisfied.

$$V_{IN} = V_{OUT} + (R_{ONP} + R_L) \times I_{OUT} + L \times I_{RP} / t_{ON} \dots \dots \dots \text{Equation 1}$$

Second, when Pch. Tr. is "OFF" (Nch. Tr. is "ON"), Equation 2 is satisfied.

$$L \times I_{RP} / t_{OFF} = R_{ONN} \times I_{OUT} + V_{OUT} + R_L \times I_{OUT} \dots \dots \dots \text{Equation 2}$$

Put Equation 2 into Equation 1 to solve ON duty of Pch. Tr. ( $D_{ON} = t_{ON} / (t_{OFF} + t_{ON})$ ):

$$D_{ON} = (V_{OUT} + R_{ONN} \times I_{OUT} + R_L \times I_{OUT}) / (V_{IN} + R_{ONN} \times I_{OUT} - R_{ONP} \times I_{OUT}) \dots \dots \dots \text{Equation 3}$$

Ripple Current is described as follows:

$$I_{RP} = (V_{IN} - V_{OUT} - R_{ONP} \times I_{OUT} - R_L \times I_{OUT}) \times D_{ON} / f_{OSC} / L \dots \dots \dots \text{Equation 4}$$

Peak current that flows through L, and LX Tr. is described as follows:

$$I_{LXMAX} = I_{OUT} + I_{RP} / 2 \dots \dots \dots \text{Equation 5}$$

## TECHNICAL NOTES

The performance of power source circuits using this IC largely depends on peripheral circuits. When selecting the peripheral components, please consider the conditions of use. Do not allow each component, PCB pattern or the IC to exceed their respected rated values (voltage, current, and power) when designing the peripheral circuits.

- Set the external components as close as possible to the IC and minimize the wiring between the components and the IC. Especially, place a capacitor ( $C_{IN}$ ) as close as possible to the VIN pin and GND.
- Ensure the VIN and GND lines are sufficiently robust. If their impedance is too high, noise pickup or unstable operation may result.
- The VIN line, the GND line, the VOUT line, an inductor, and LX should make special considerations for the large switching current flows.
- The wiring between the VOUT pin and an inductor (L) (RP509xxxXA/B) or between a resistor for setting output voltage (R1) and L (RP509x00XC/D) should be separated from the wiring between L and Load.
- Over current protection circuit may be affected by self-heating or power dissipation environment.
- In the case of the adjustable output voltage type, the input / output voltage ratio must become the following condition to achieve a high-efficiency with stable VFM mode at light load when the MODE pin is "L".

$$V_{OUT} / V_{IN} < 0.7$$

$V_{MODE} = "L"$  PWM/VFM Auto Switching

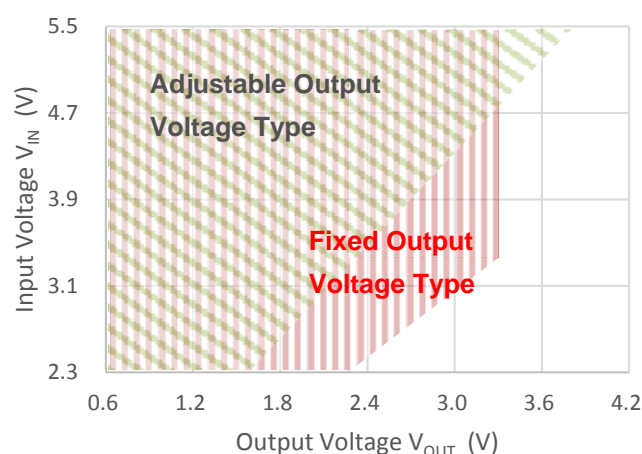

**Available Voltage Area with Stable VFM Mode (Adjustable Output Voltage Type)**

# RP509x

NO.EA-362-160510

## TYPICAL CHARACTERISTICS

Typical Characteristics in RP509Z are intended to be used as reference data, and they are not guaranteed.

### 1) Efficiency vs. Output Current

$V_{OUT} = 1.0\text{ V}$

$V_{MODE} = \text{"L" PWM/VFM Auto Switching}$

L = MIPSZ2012D0R5

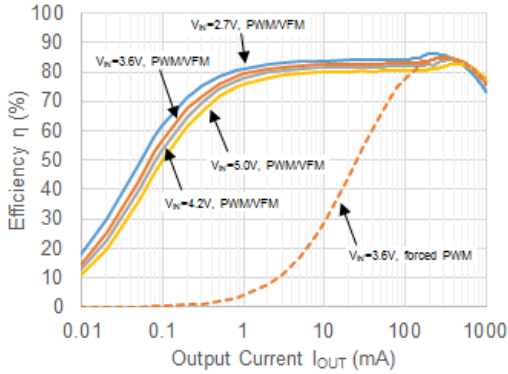

$V_{OUT} = 1.2\text{ V}$

$V_{MODE} = \text{"L" PWM/VFM Auto Switching}$

L = MIPSZ2012D0R5

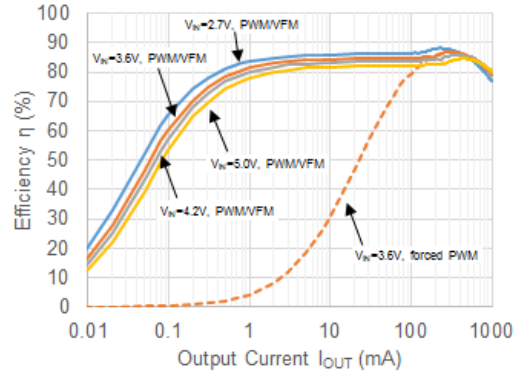

$V_{OUT} = 1.8\text{ V}$

$V_{MODE} = \text{"L" PWM/VFM Auto Switching}$

L = MIPSZ2012D0R5

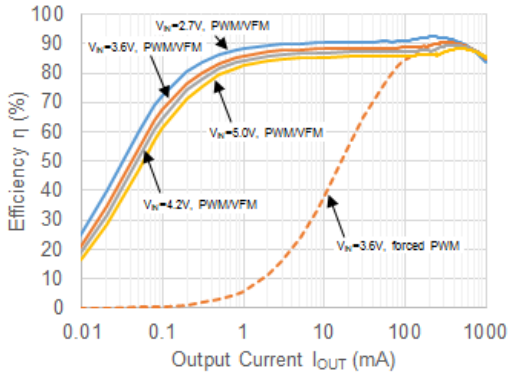

$V_{OUT} = 3.3\text{ V (Fixed Output Voltage Type)}$

$V_{MODE} = \text{"L" PWM/VFM Auto Switching}$

L = MIPSZ2012D0R5

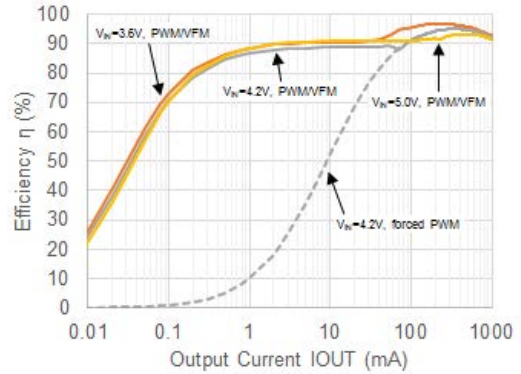

$V_{OUT} = 1.8\text{ V}$

$V_{MODE} = \text{"H" Forced PWM Mode}$

L = MIPSZ2012D0R5

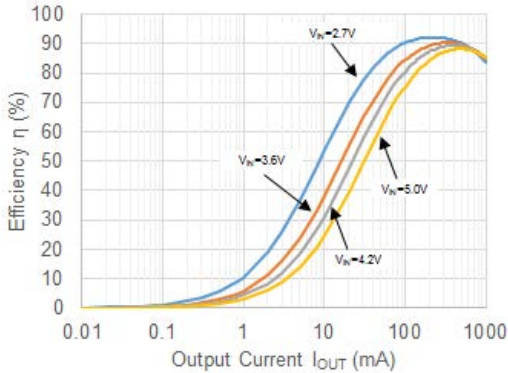



[Small Mount Solution]

$V_{OUT} = 1.0\text{ V}$   
 $V_{MODE} = \text{"L" PWM/VFM Auto Switching}$   
 $L = \text{MDT1608-CRR47M}$

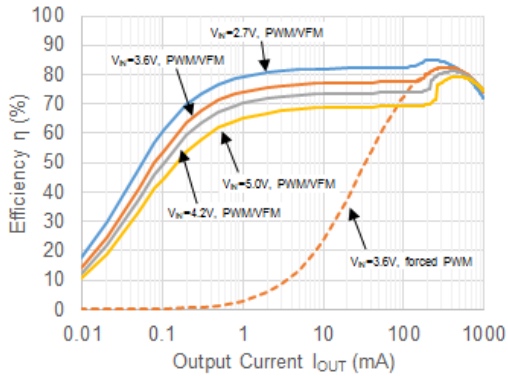

$V_{OUT} = 1.2\text{ V}$   
 $V_{MODE} = \text{"L" PWM/VFM Auto Switching}$   
 $L = \text{MDT1608-CRR47M}$

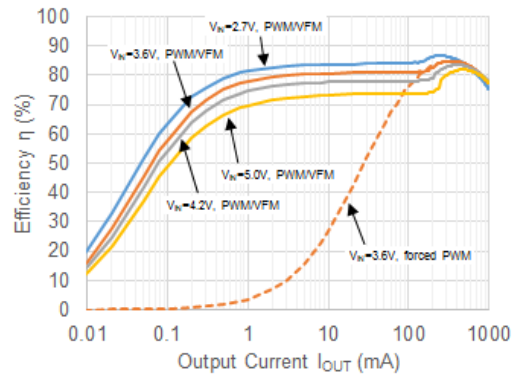

$V_{OUT} = 1.8\text{ V}$   
 $V_{MODE} = \text{"L" PWM/VFM Auto Switching}$   
 $L = \text{MDT1608-CRR47M}$

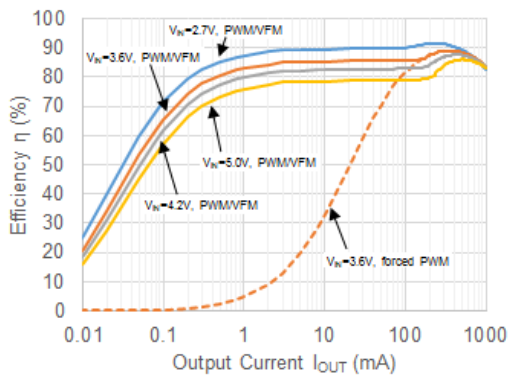

$V_{OUT} = 3.3\text{ V (Fixed Output Voltage Type)}$   
 $V_{MODE} = \text{"L" PWM/VFM Auto Switching}$   
 $L = \text{MDT1608-CRR47M}$

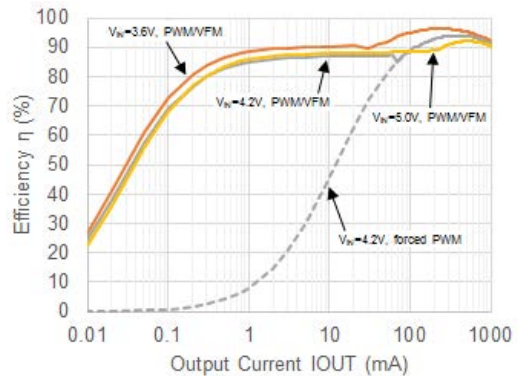

$V_{OUT} = 1.8\text{ V}$   
 $V_{MODE} = \text{"H" Forced PWM Mode}$   
 $L = \text{MDT1608-CRR47M}$

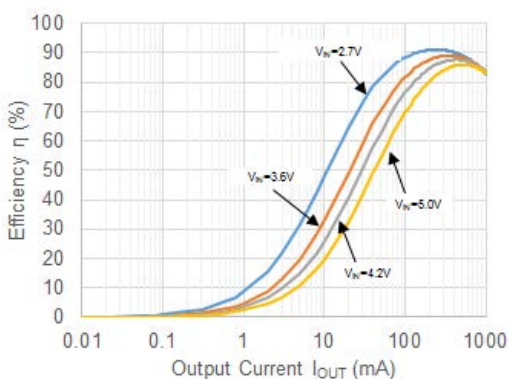

**2) Output Voltage vs. Output Current**

$V_{IN} = 3.6\text{ V}$ ,  $V_{OUT} = 1.8\text{ V}$

$V_{MODE} = \text{"L"}$  PWM/VFM Auto Switching

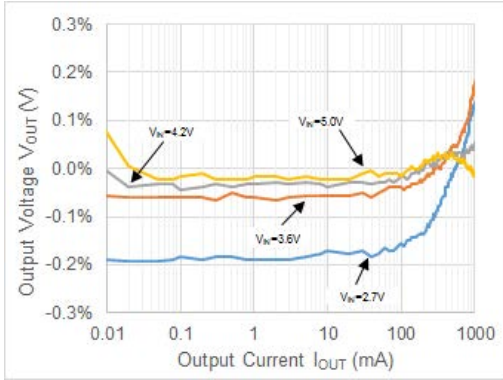

$V_{IN} = 3.6\text{ V}$ ,  $V_{OUT} = 1.8\text{ V}$

$V_{MODE} = \text{"H"}$  Forced PWM Mode

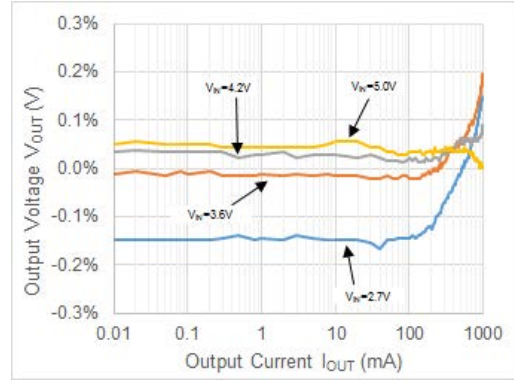

**3) Oscillator Frequency vs. Input Voltage**

$I_{OUT} = 1.0\text{ mA}$

$V_{MODE} = \text{"L"}$  PWM/VFM Auto Switching

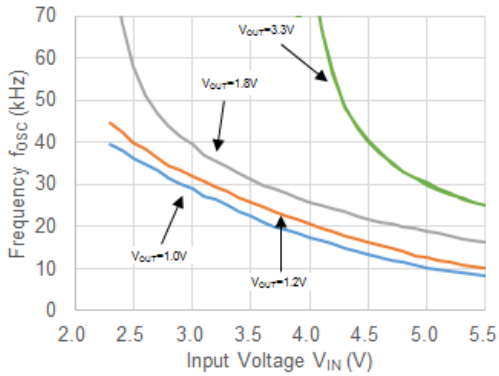

$I_{OUT} = 1.0\text{ mA}$

$V_{MODE} = \text{"H"}$  Forced PWM Mode

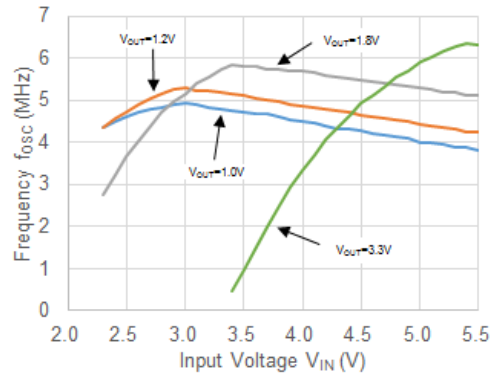

$I_{OUT} = 500\text{ mA}$

$V_{MODE} = \text{"H"}$  Forced PWM Mode

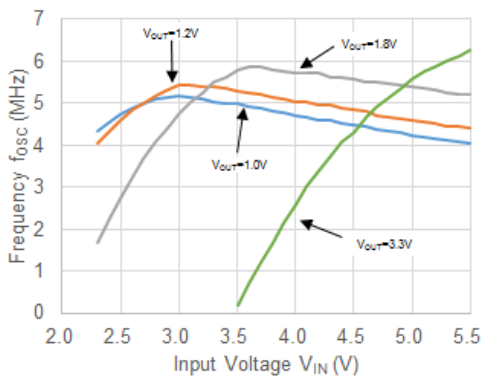

**4) Load Transient Response Waveform**

$V_{IN} = 3.6\text{ V}$ ,  $V_{OUT} = 1.8\text{ V}$

$V_{MODE} = \text{"L"}$  PWM/VFM Auto Switching

$I_{OUT} = 1.0 \rightarrow 500\text{ mA}$

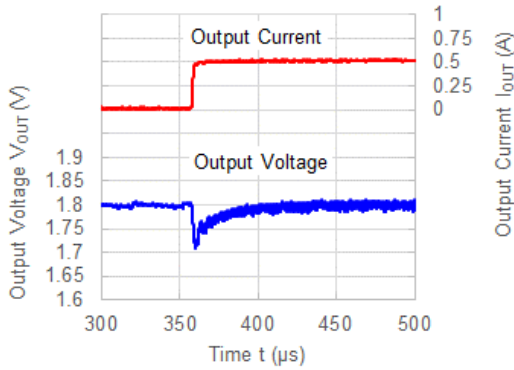

$V_{IN} = 3.6\text{ V}$ ,  $V_{OUT} = 1.8\text{ V}$

$V_{MODE} = \text{"L"}$  PWM/VFM Auto Switching

$I_{OUT} = 500 \rightarrow 1.0\text{ mA}$

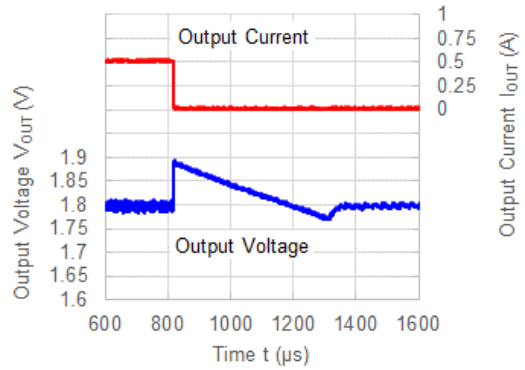

$V_{IN} = 3.6\text{ V}$ ,  $V_{OUT} = 1.8\text{ V}$

$V_{MODE} = \text{"H"}$  Forced PWM Mode

$I_{OUT} = 1.0 \rightarrow 500\text{ mA}$

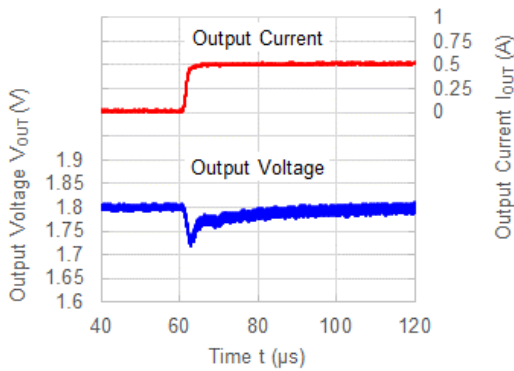

$V_{IN} = 3.6\text{ V}$ ,  $V_{OUT} = 1.8\text{ V}$

$V_{MODE} = \text{"H"}$  Forced PWM Mode

$I_{OUT} = 500 \rightarrow 1.0\text{ mA}$

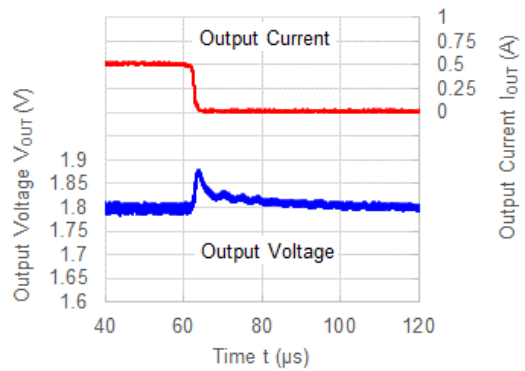

$V_{IN} = 3.6\text{ V}$ ,  $V_{OUT} = 1.8\text{ V}$

$V_{MODE} = \text{"L"}$  PWM/VFM Auto Switching

$I_{OUT} = 300 \rightarrow 600\text{ mA}$

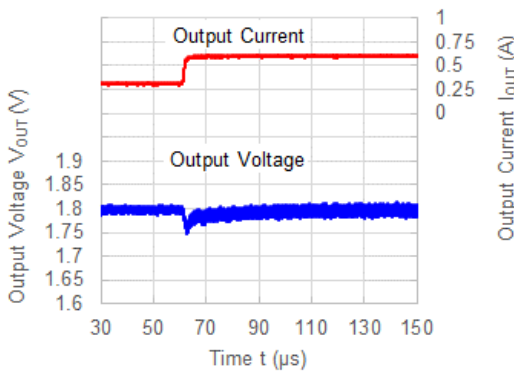

$V_{IN} = 3.6\text{ V}$ ,  $V_{OUT} = 1.8\text{ V}$

$V_{MODE} = \text{"L"}$  PWM/VFM Auto Switching

$I_{OUT} = 600 \rightarrow 300\text{ mA}$

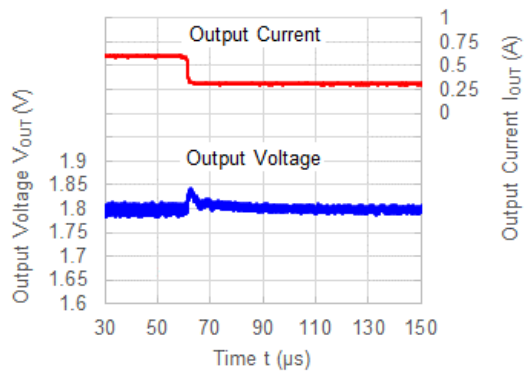

# RP509x

NO.EA-362-160510

$V_{IN} = 3.6\text{ V}$ ,  $V_{OUT} = 1.8\text{ V}$   
 $V_{MODE} = \text{"H"}$  Forced PWM Mode  
 $I_{OUT} = 300 \rightarrow 600\text{ mA}$

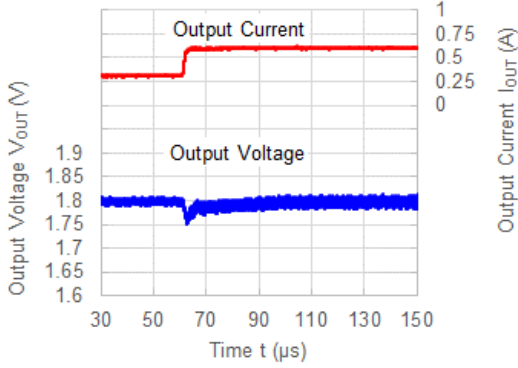

$V_{IN} = 3.6\text{ V}$ ,  $V_{OUT} = 1.8\text{ V}$   
 $V_{MODE} = \text{"H"}$  Forced PWM Mode  
 $I_{OUT} = 600 \rightarrow 300\text{ mA}$

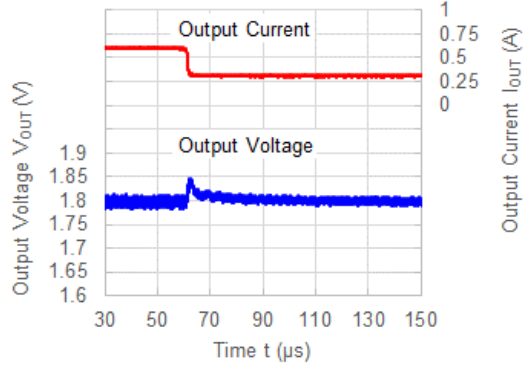

## 5) Mode Switching Waveform

$V_{IN} = 3.6\text{ V}$ ,  $V_{OUT} = 1.8\text{ V}$   
 $I_{OUT} = 1.0\text{ mA}$   
 $V_{MODE} = \text{"L"} \rightarrow \text{"H"}$

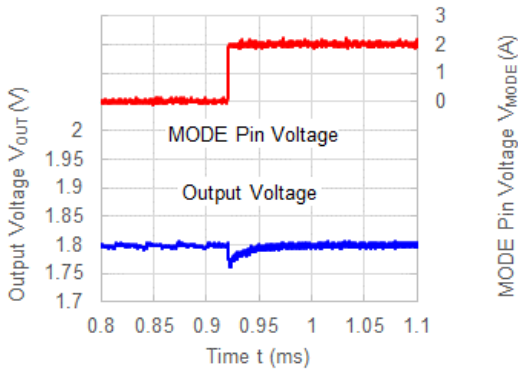

$V_{IN} = 3.6\text{ V}$ ,  $V_{OUT} = 1.8\text{ V}$   
 $I_{OUT} = 1.0\text{ mA}$   
 $V_{MODE} = \text{"H"} \rightarrow \text{"L"}$

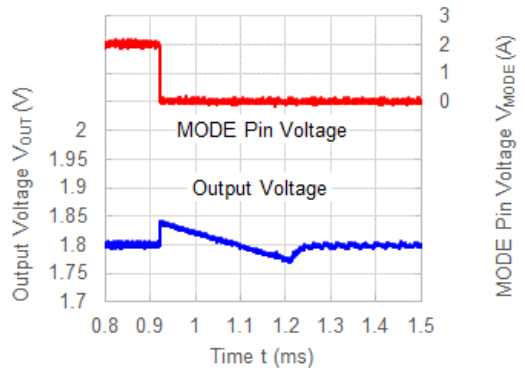

## 6) Output Voltage Waveform

$V_{IN} = 3.6\text{ V}$ ,  $V_{OUT} = 1.8\text{ V}$   
 $V_{MODE} = \text{"L"}$  PWM/VFM Auto Switching  
 $I_{OUT} = 1.0\text{ mA}$

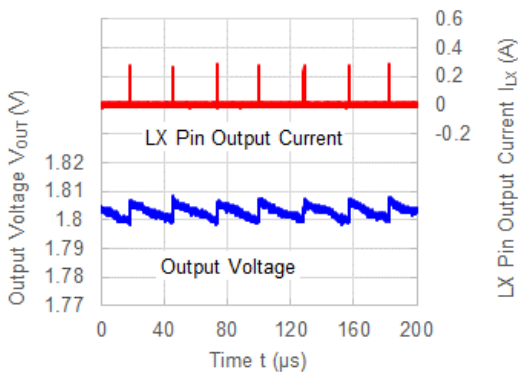

$V_{IN} = 3.6\text{ V}$ ,  $V_{OUT} = 1.8\text{ V}$   
 $V_{MODE} = \text{"H"}$  Forced PWM Mode  
 $I_{OUT} = 1.0\text{ mA}$

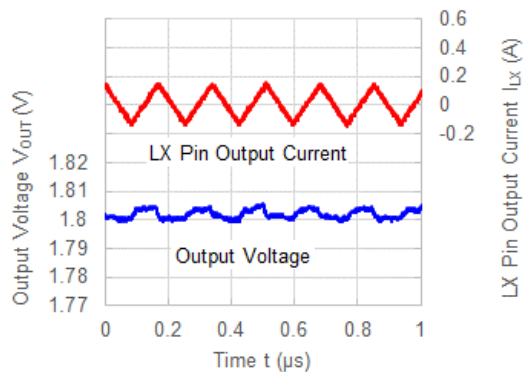

$V_{IN} = 3.6\text{ V}$ ,  $V_{OUT} = 1.8\text{ V}$   
 $V_{MODE} = \text{"L"}$  PWM/VFM Auto Switching  
 $I_{OUT} = 500\text{ mA}$

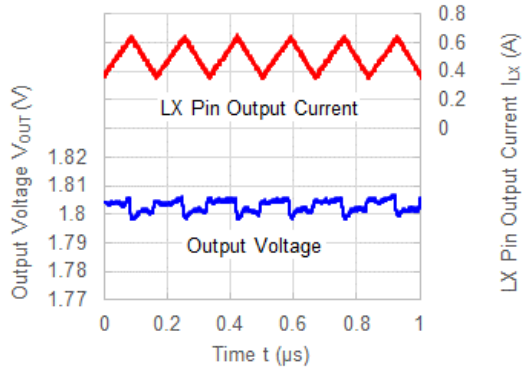

$V_{IN} = 3.6\text{ V}$ ,  $V_{OUT} = 1.8\text{ V}$   
 $V_{MODE} = \text{"H"}$  Forced PWM Mode  
 $I_{OUT} = 500\text{ mA}$

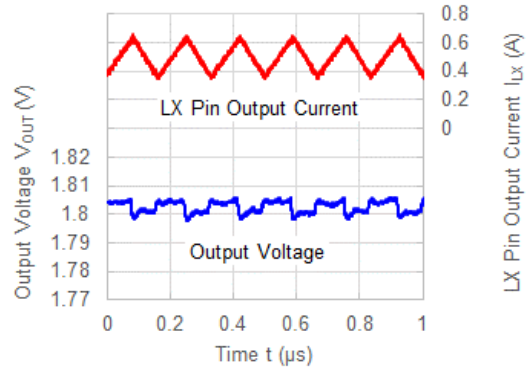

The power dissipation of the package is dependent on PCB material, layout, and environmental conditions. The following conditions are used in this measurement.

**Measurement Conditions**

	<b>JEDEC STD. 51-9 Test Land Pattern</b>
Environment	Mounting on Board (Wind Velocity = 0 m/s)
Board Material	Glass Cloth Epoxy Plastic (Four-Layer Board)
Board Dimensions	101.5 mm x 114.5 mm x 1.6 mm
Copper Ratio	Outer Layers (First and Fourth Layers): 60% Inner Layers (Second and Third Layers): 100%

**Measurement Result**

(Ta = 25°C, Tjmax = 125°C)

	<b>JEDEC STD. 51-9 Test Land Pattern</b>
Power Dissipation	910 mW
Thermal Resistance	$\theta_{ja} = (125 - 25^\circ\text{C}) / 0.91 \text{ W} = 109 \text{ }^\circ\text{C/W}$

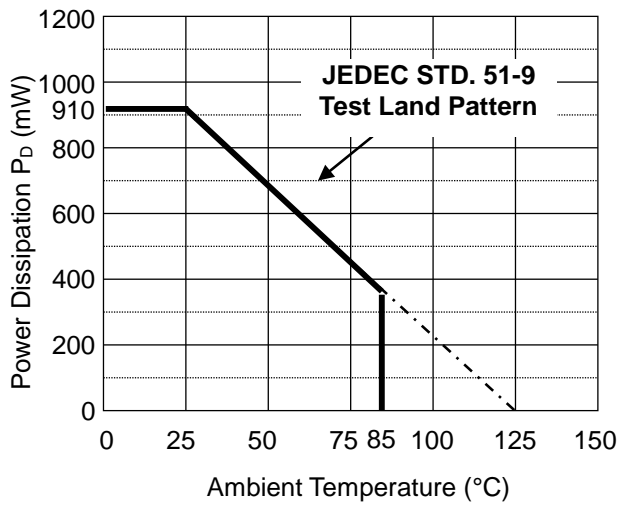

**Power Dissipation vs. Ambient Temperature**

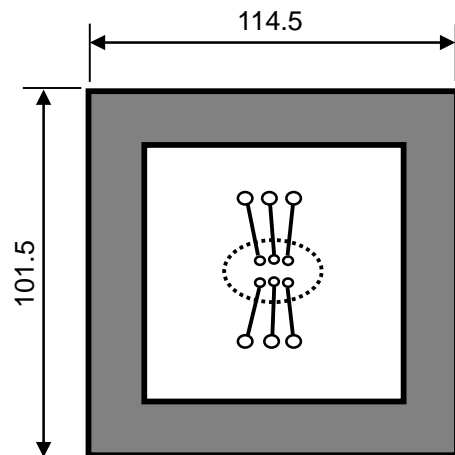

**Measurement Board Pattern**

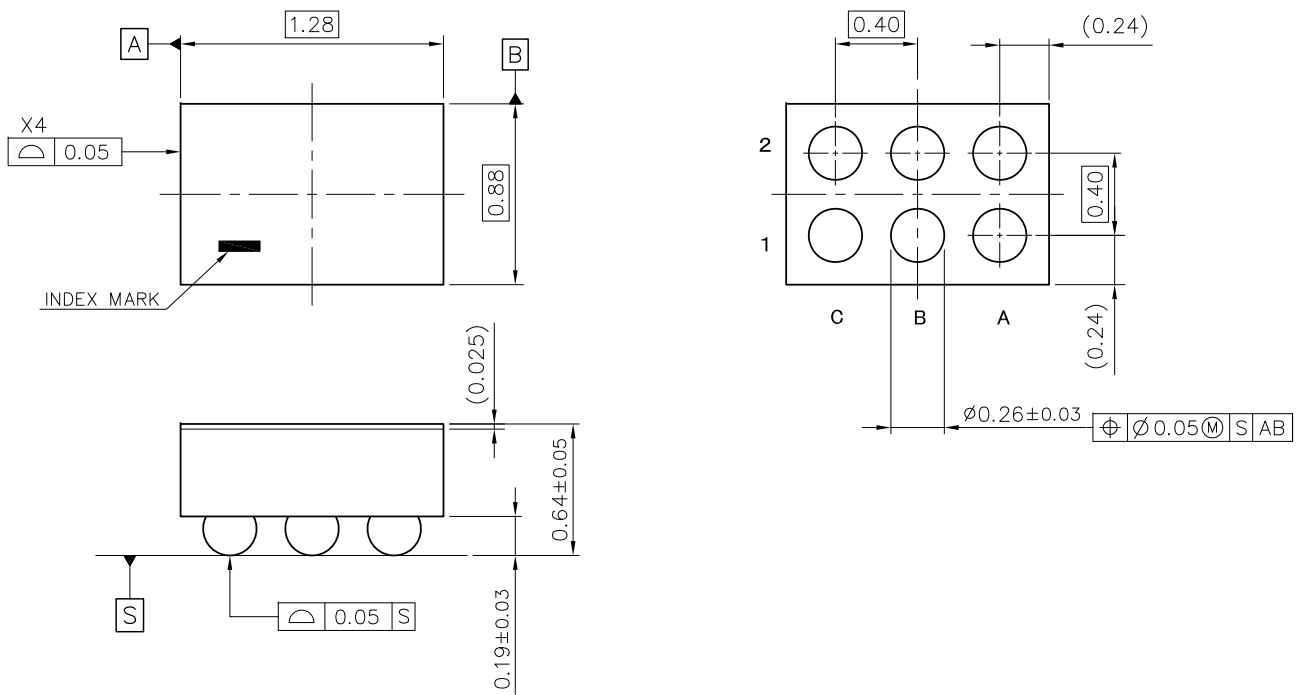

**WLCSP-6-P6 Package Dimensions (Unit: mm)**

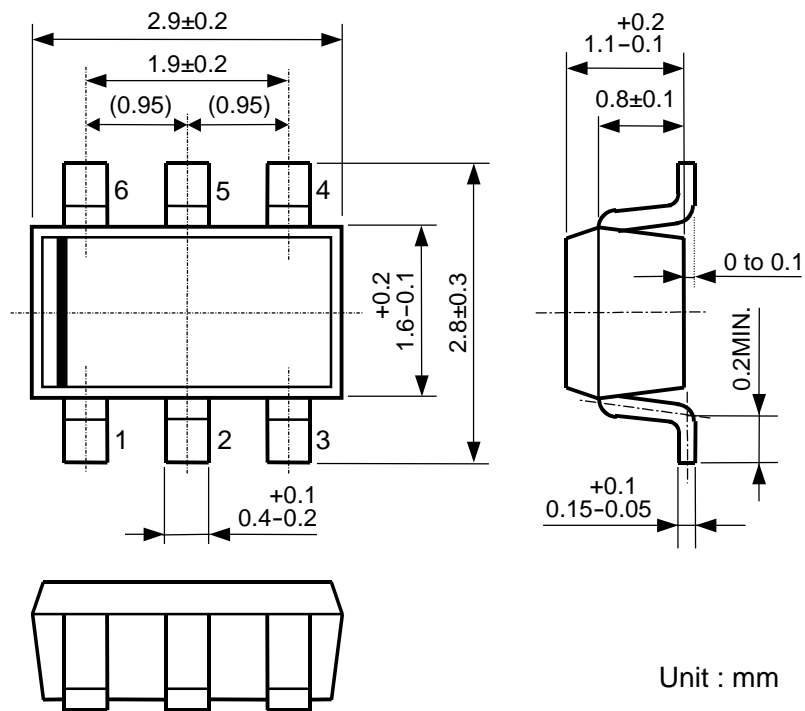

SOT-23-6 Package Dimensions (Unit: mm)





1. The products and the product specifications described in this document are subject to change or discontinuation of production without notice for reasons such as improvement. Therefore, before deciding to use the products, please refer to Ricoh sales representatives for the latest information thereon.
2. The materials in this document may not be copied or otherwise reproduced in whole or in part without prior written consent of Ricoh.
3. Please be sure to take any necessary formalities under relevant laws or regulations before exporting or otherwise taking out of your country the products or the technical information described herein.
4. The technical information described in this document shows typical characteristics of and example application circuits for the products. The release of such information is not to be construed as a warranty of or a grant of license under Ricoh's or any third party's intellectual property rights or any other rights.
5. The products listed in this document are intended and designed for use as general electronic components in standard applications (office equipment, telecommunication equipment, measuring instruments, consumer electronic products, amusement equipment etc.). Those customers intending to use a product in an application requiring extreme quality and reliability, for example, in a highly specific application where the failure or misoperation of the product could result in human injury or death (aircraft, spacevehicle, nuclear reactor control system, traffic control system, automotive and transportation equipment, combustion equipment, safety devices, life support system etc.) should first contact us.
6. We are making our continuous effort to improve the quality and reliability of our products, but semiconductor products are likely to fail with certain probability. In order to prevent any injury to persons or damages to property resulting from such failure, customers should be careful enough to incorporate safety measures in their design, such as redundancy feature, fire containment feature and fail-safe feature. We do not assume any liability or responsibility for any loss or damage arising from misuse or inappropriate use of the products.
7. Anti-radiation design is not implemented in the products described in this document.
8. Please contact Ricoh sales representatives should you have any questions or comments concerning the products or the technical information.



**Ricoh is committed to reducing the environmental loading materials in electrical devices with a view to contributing to the protection of human health and the environment.**

Ricoh has been providing RoHS compliant products since April 1, 2006 and Halogen-free products since April 1, 2012.

**RICOH** RICOH ELECTRONIC DEVICES CO., LTD.

<http://www.e-devices.ricoh.co.jp/en/>

#### Sales & Support Offices

##### **RICOH ELECTRONIC DEVICES CO., LTD.**

**Higashi-Shinagawa Office (International Sales)**  
3-32-3, Higashi-Shinagawa, Shinagawa-ku, Tokyo 140-8655, Japan  
Phone: +81-3-5479-2857 Fax: +81-3-5479-0502

##### **RICOH EUROPE (NETHERLANDS) B.V.**

**Semiconductor Support Centre**  
Prof. W.H. Keesomlaan 1, 1183 DJ Amstelveen, The Netherlands  
Phone: +31-20-5474-309

##### **RICOH INTERNATIONAL B.V. - German Branch**

**Semiconductor Sales and Support Centre**  
Oberrather Strasse 6, 40472 Düsseldorf, Germany  
Phone: +49-211-6546-0

##### **RICOH ELECTRONIC DEVICES KOREA CO., LTD.**

3F, Haesung Bldg, 504, Teheran-ro, Gangnam-gu, Seoul, 135-725, Korea  
Phone: +82-2-2135-5700 Fax: +82-2-2051-5713

##### **RICOH ELECTRONIC DEVICES SHANGHAI CO., LTD.**

Room 403, No.2 Building, No.690 Bibo Road, Pu Dong New District, Shanghai 201203, People's Republic of China  
Phone: +86-21-5027-3200 Fax: +86-21-5027-3299

##### **RICOH ELECTRONIC DEVICES CO., LTD.**

**Taipei office**  
Room 109, 10F-1, No.51, Hengyang Rd., Taipei City, Taiwan (R.O.C.)  
Phone: +886-2-2313-1621/1622 Fax: +886-2-2313-1623

# Mouser Electronics

Authorized Distributor

Click to View Pricing, Inventory, Delivery & Lifecycle Information:

[Ricoch Electronics:](#)

[RP509Z002D-E2-F](#) [RP509Z202B-E2-F](#) [RP509Z121B-E2-F](#)

Компания «Океан Электроники» предлагает заключение долгосрочных отношений при поставках импортных электронных компонентов на взаимовыгодных условиях!

Наши преимущества:

- Поставка оригинальных импортных электронных компонентов напрямую с производств Америки, Европы и Азии, а так же с крупнейших складов мира;
- Широкая линейка поставок активных и пассивных импортных электронных компонентов (более 30 млн. наименований);
- Поставка сложных, дефицитных, либо снятых с производства позиций;
- Оперативные сроки поставки под заказ (от 5 рабочих дней);
- Экспресс доставка в любую точку России;
- Помощь Конструкторского Отдела и консультации квалифицированных инженеров;
- Техническая поддержка проекта, помощь в подборе аналогов, поставка прототипов;
- Поставка электронных компонентов под контролем ВП;
- Система менеджмента качества сертифицирована по Международному стандарту ISO 9001;
- При необходимости вся продукция военного и аэрокосмического назначения проходит испытания и сертификацию в лаборатории (по согласованию с заказчиком);
- Поставка специализированных компонентов военного и аэрокосмического уровня качества (Xilinx, Altera, Analog Devices, Intersil, Interpoint, Microsemi, Actel, Aeroflex, Peregrine, VPT, Syfer, Eurofarad, Texas Instruments, MS Kennedy, Miteq, Cobham, E2V, MA-COM, Hittite, Mini-Circuits, General Dynamics и др.);

Компания «Океан Электроники» является официальным дистрибьютором и эксклюзивным представителем в России одного из крупнейших производителей разъемов военного и аэрокосмического назначения «JONHON», а так же официальным дистрибьютором и эксклюзивным представителем в России производителя высокотехнологичных и надежных решений для передачи СВЧ сигналов «FORSTAR».



## JONHON

«JONHON» (основан в 1970 г.)

Разъемы специального, военного и аэрокосмического назначения:

(Применяются в военной, авиационной, аэрокосмической, морской, железнодорожной, горно- и нефтедобывающей отраслях промышленности)

«FORSTAR» (основан в 1998 г.)

ВЧ соединители, коаксиальные кабели, кабельные сборки и микроволновые компоненты:

(Применяются в телекоммуникациях гражданского и специального назначения, в средствах связи, РЛС, а так же военной, авиационной и аэрокосмической отраслях промышленности).



Телефон: 8 (812) 309-75-97 (многоканальный)

Факс: 8 (812) 320-03-32

Электронная почта: [ocean@oceanchips.ru](mailto:ocean@oceanchips.ru)

Web: <http://oceanchips.ru/>

Адрес: 198099, г. Санкт-Петербург, ул. Калинина, д. 2, корп. 4, лит. А