

AG606

Push-Pull CATV Amplifier



Product Features

- 50 – 1000 MHz
- ± 0.7 dB Gain Flatness
- +20 dBm P1dB
- +37 dBm Output IP3
- +73 dBm Output IP2
- -68 dBc CTB
+34 dBmV/channel, 79 channels
- -80 dBc CSO
+34 dBmV/channel, 79 channels
- Matched amplifiers for a push-pull configuration
- +7V Single Positive Supply
- MTTF > 1000 Years

Product Description

The AG606 is a dual amplifier containing two internal matched amplifiers optimal for a push-pull configuration. The internal amplifiers employ InGaP HBT technology for a cost-effective low-distortion solution.

The AG606 is ideal for drop amplifiers, splitters, and other low to moderate power outside plant CATV applications. The amplifier can also be useful in low power headend applications such as linear laser drivers.

The AG606 has excellent VSWR when used in a 75 Ω push-pull configuration. It is provided in a low-cost environmentally-friendly lead-free/green/ RoHS-compliant SOIC-8 package.

Functional Diagram

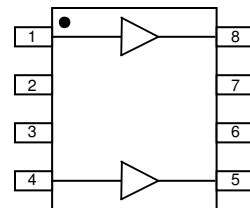

Function	Pin No.
Amp 1 Input	1
Amp 2 Input	4
Amp 2 Output	5
Amp 1 Output	8
Ground	2, 3, 6, 7, Backside paddle

Applications

- CATV Head End Equipment
- CATV Line Amplifiers
- FTTH Repeaters

Single-ended Device Specifications ⁽¹⁾

Parameter	Units	Min	Typ	Max
Test Frequency	MHz		800	
Gain	dB	13.2	14.3	15.5
Output IP3 ⁽²⁾	dBm	+33.5	+36	
Device Current	mA	76	82.5	90
Device Voltage	V		5.25	

1. Test conditions unless otherwise noted: T = 25 °C, 800 MHz on each individual single-branch amplifier in a 50 Ω test fixture using a +7V supply and a 20.5 Ω dropping resistor.
2. 3OIP measured with two tones at an output power of +5 dBm/ tone separated by 1 MHz. The suppression on the largest IM3 product is used to calculate the 3OIP using a 2:1 rule.
3. Typical parameters reflect performance in a push-pull application circuit.
4. Balun, board, and connector losses have not been extracted, but typically account of 0.4 dB loss midband and 1.1 dB loss at 860 MHz.
5. Measured at +34 dBmV/channel, 79 channels Flat Loading.
6. OIP2 is measured at f1 + f2 at +5 dBm / tone.

Typical Performance ⁽³⁾

Parameter	Units	Typical			
Frequency	MHz	50	250	450	860
Gain ⁽⁴⁾	dB	14.3	14.2	13.9	12.9
Input R. L.	dB	21	28	18	11
Output R. L.	dB	17	18	16	18
CTB ⁽⁵⁾	dBc	-69	-67	-67	
CSO ⁽⁵⁾	dBc	-81	-87	-80	
XMOD ⁽⁵⁾	dBc	-60	-61	-60	
Output P1dB	dBm	+20.7	+20.5	+20.3	+22
Output IP2 ⁽⁶⁾	dBm	+73.6	+76.1	+76.4	+76.6
Output IP3 ⁽²⁾	dBm	+37.5	+37.5	+37.3	+39.2
Noise Figure ⁽⁴⁾	dB	5	5	5.3	5.9
Device Bias	V	+5.25 V @ 165 mA			

Absolute Maximum Rating

Parameter	Rating
Storage Temperature	-55 to +125 °C
Supply Voltage	+7 V
RF Input Power (continuous)	+13dBm
Thermal Resistance, R _{th}	63 °C/W
Max Junction Temperature, T _j For 10 ⁶ hours MTTF	177 °C

Operation of this device above any of these parameters may cause permanent damage.

Ordering Information

Part No.	Description
AG606-G	Push-pull CATV Amplifier (lead-free /Green/ RoHS-compliant SOIC8 Pkg)
AG606-PCB	Fully Assembled CATV Evaluation Board

Standard T/R size = 500 pieces on a 7" reel.

Typical Device Data – 50Ω Z₀

S-Parameters (V_{dev} = +5.25 V, I_{cc} = 82.5 mA, T = 25 °C, unmatched 50 ohm system, calibrated to device leads)
 These represent a single-ended amplifier in the AG606, with there being two matched amplifiers inside the package.

Freq (MHz)	S11 (dB)	S11 (ang)	S21 (dB)	S21 (ang)	S12 (dB)	S12 (ang)	S22 (dB)	S22 (ang)
50	-12.03	178.56	14.61	177.32	-18.85	-0.01	-17.45	178.57
100	-12.09	174.32	14.61	175.28	-18.74	-1.56	-17.08	178.23
150	-11.81	172.20	14.62	173.13	-18.76	-2.21	-17.28	176.63
200	-11.81	169.91	14.59	170.74	-18.81	-3.25	-16.86	176.45
250	-11.64	168.30	14.62	168.67	-18.77	-3.74	-17.24	173.88
300	-11.79	166.47	14.63	165.71	-18.81	-4.12	-17.00	174.14
350	-11.76	164.70	14.68	163.24	-18.79	-4.96	-17.20	172.40
400	-12.02	162.35	14.59	161.23	-18.84	-5.99	-16.85	173.24
450	-11.92	159.27	14.48	158.25	-18.82	-5.99	-17.02	170.87
500	-11.92	156.13	14.53	156.14	-18.80	-6.63	-16.70	169.98
550	-11.77	154.71	14.48	154.05	-18.86	-7.58	-16.78	167.35
600	-11.75	151.64	14.52	151.45	-18.79	-8.02	-16.47	167.79
650	-11.67	150.04	14.45	148.59	-18.74	-9.17	-16.49	164.94
700	-11.89	147.47	14.41	146.59	-18.83	-9.41	-16.48	164.76
750	-11.72	145.07	14.43	144.30	-18.89	-10.48	-16.43	161.86
800	-11.76	143.08	14.33	141.92	-18.87	-11.22	-16.23	161.91
850	-11.56	141.20	14.36	139.40	-18.87	-11.88	-15.86	158.92
900	-11.65	138.97	14.26	137.14	-18.80	-12.23	-15.78	159.88
950	-11.57	137.28	14.28	134.86	-18.79	-13.52	-15.51	156.89
1000	-11.56	135.12	14.19	132.17	-18.86	-13.15	-15.34	156.79

Typical Device Data – 50Ω Z₀

S-Parameters (V_{dev} = +5.25 V, I_{cc} = 82.5 mA, T = 25 °C, unmatched 37.5 ohm system, calibrated to device leads)
 These represent a single-ended amplifier in the AG606, with there being two matched amplifiers inside the package.

Freq (MHz)	S11 (dB)	S11 (ang)	S21 (dB)	S21 (ang)	S12 (dB)	S12 (ang)	S22 (dB)	S22 (ang)
50	-34.66	173.49	14.79	177.27	-18.66	-0.06	-19.98	-0.57
100	-33.64	133.95	14.81	175.12	-18.54	-1.71	-20.40	-3.63
150	-30.17	137.29	14.82	172.89	-18.56	-2.45	-20.15	-4.04
200	-29.21	131.02	14.80	170.45	-18.60	-3.54	-20.91	-7.28
250	-27.90	131.37	14.83	168.30	-18.57	-4.11	-20.34	-5.91
300	-28.12	124.34	14.84	165.33	-18.61	-4.51	-20.82	-9.61
350	-27.59	122.31	14.88	162.80	-18.59	-5.40	-20.57	-10.25
400	-27.52	110.86	14.79	160.77	-18.65	-6.45	-21.33	-14.80
450	-25.69	107.75	14.68	157.66	-18.62	-6.58	-21.31	-13.74
500	-24.49	101.63	14.73	155.45	-18.61	-7.32	-21.94	-15.66
550	-23.76	104.95	14.68	153.27	-18.66	-8.35	-22.13	-13.89
600	-22.84	100.16	14.72	150.61	-18.59	-8.86	-22.79	-18.83
650	-22.46	101.72	14.65	147.66	-18.53	-10.10	-23.13	-17.61
700	-22.06	95.00	14.60	145.62	-18.64	-10.38	-23.54	-19.44
750	-21.15	95.84	14.62	143.20	-18.70	-11.58	-24.06	-16.74
800	-20.79	94.07	14.53	140.77	-18.68	-12.37	-25.05	-20.60
850	-20.09	95.55	14.56	138.11	-18.67	-13.17	-26.61	-16.06
900	-19.78	92.24	14.45	135.83	-18.60	-13.53	-27.43	-23.50
950	-19.42	92.70	14.48	133.44	-18.59	-14.94	-29.28	-17.34
1000	-18.88	90.91	14.39	130.68	-18.66	-14.64	-31.32	-18.82

Application Circuit PC Board Layout

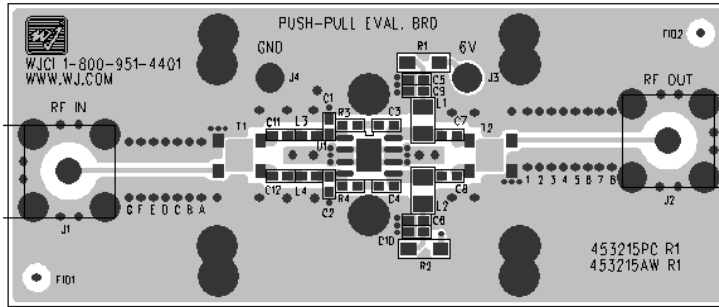

Circuit Board Material: .028" FR4, 4 - layer, 1 oz copper, Microstrip line details: width = .021", spacing = .021". C1, C2, R3, C3, R4 and C4 are shown in the silkscreen but are not required in the schematic.

Typical RF Performance at 25 °C

Frequency	MHz	50	250	450	860
Gain ⁽¹⁾	dB	14.3	14.2	13.9	12.9
Input R.L.	dB	21	28	18	11
Output R.L.	dB	17	18	16	18
CTB ⁽²⁾	dBc	-69	-67	-67	
CSO ⁽²⁾	dBc	-81	-87	-80	
XMOD ⁽²⁾	dBc	-60	-61	-60	
Output P1dB	dBm	+20.7	+20.5	+20.3	+22
Output IP2 ⁽³⁾	dBm	+73.6	+76.1	+76.4	+76.6
Output IP3 ⁽⁴⁾	dBm	+37.5	+37.5	+37.3	+39.2
Noise Figure ⁽¹⁾	dB	5	5	5.3	5.9
Device Current	mA	165			
Device Voltage	V	+5.25			

- Balun, board, and connector losses have not been extracted, but typically account for 0.4 dB loss midband and 1.1 dB loss at 860 MHz.
- CSO, CTB, & XMOD are measured at +34 dBm/channel, 79 channels Flat Loading.
- OIP2 is measured at f1 + f2 at 5 dBm / tone.
- OIP3 is measured at +5 dBm / tone with 1 MHz spacing.

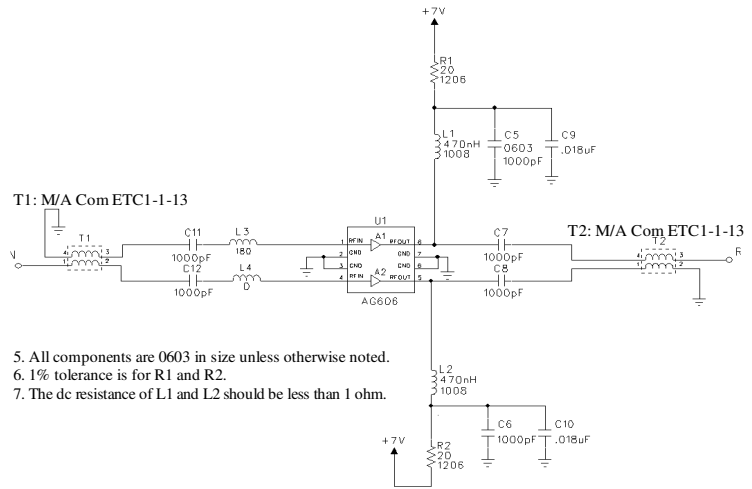

- All components are 0603 in size unless otherwise noted.
- 1% tolerance is for R1 and R2.
- The dc resistance of L1 and L2 should be less than 1 ohm.

Recommended Bias Resistor Values

Supply Voltage	R1/R2 Value	Size
7 V	20.5 ohms	1206
8 V	32.5 ohms	1210
9 V	44.5 ohms	2010
10 V	56.5 ohms	2010
12 V	81 ohms	2010
24 V	227 ohms	2 Watts

75 Ω Push-Pull Application Circuit Performance (Vsupply = +7 V, Rbias = 20.5 Ω, 25 °C)

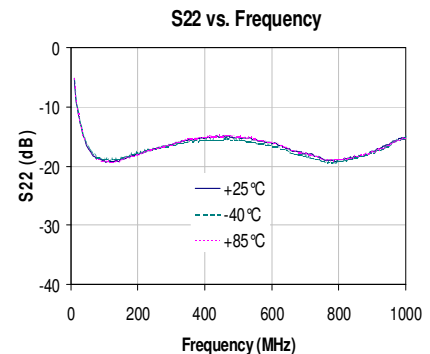
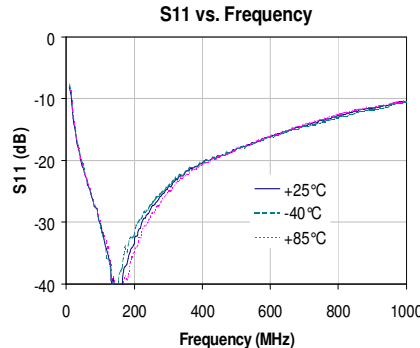
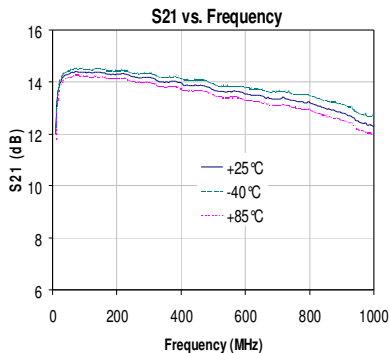

75 Ω Push-Pull Application Circuit Performance (Cont'd)

(Vsupply=7V, Rbias= 20.5 Ω , 25 $^{\circ}$ C)

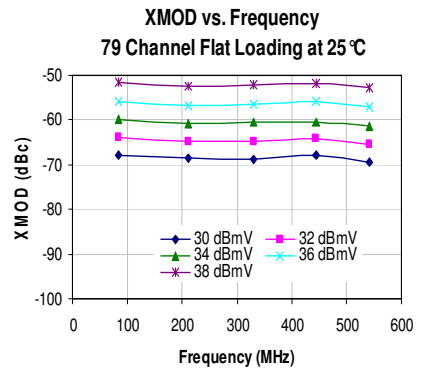
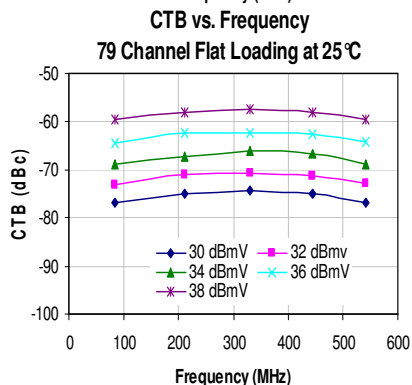
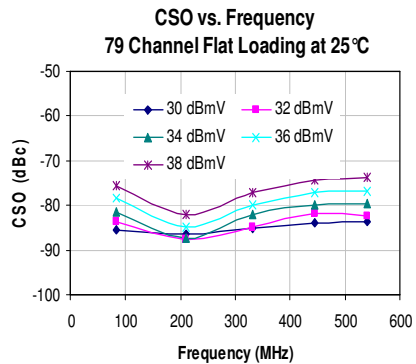
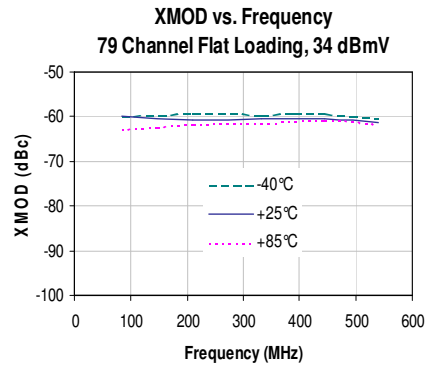
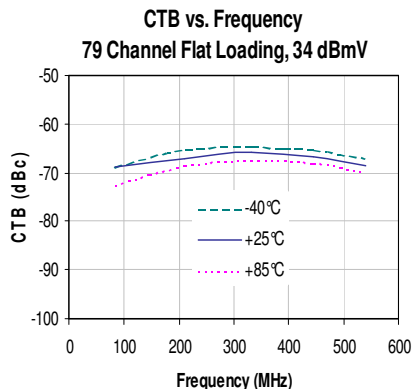
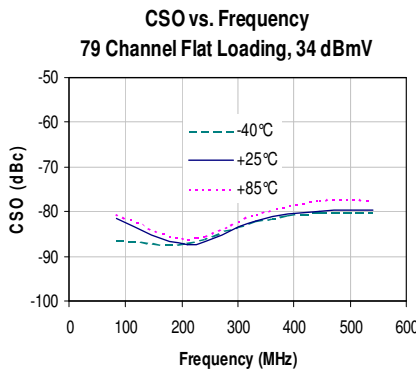
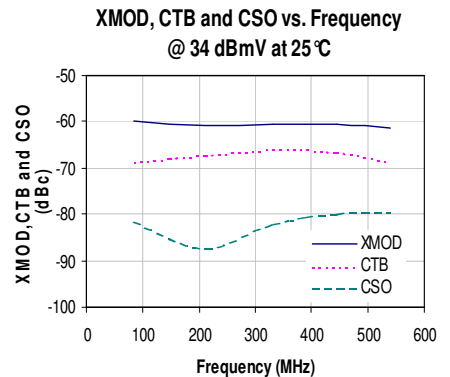
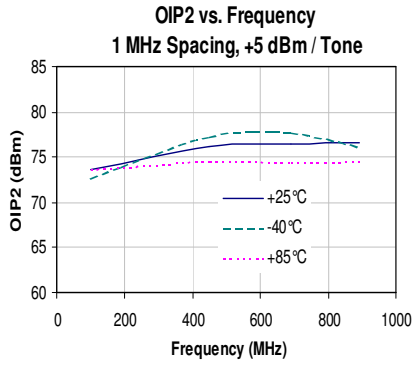
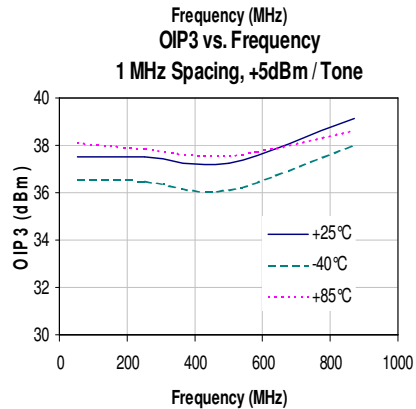
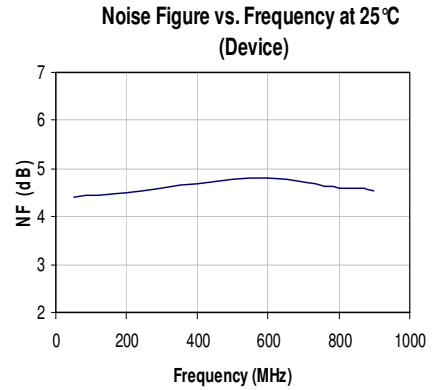
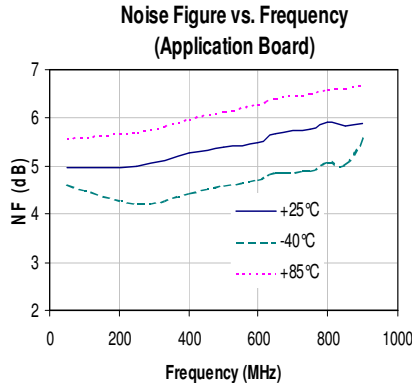
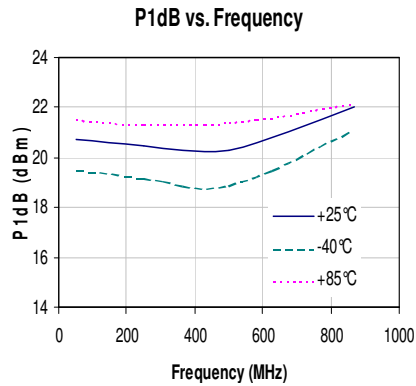

AG606-G (Lead-Free Package) Mechanical Information

This package is lead-free /green/ RoHS-compliant. The plating material on the leads is NiPdAu. It is compatible with both lead-free (maximum 260 °C reflow temperature) and lead (maximum 245 °C reflow temperature) soldering processes.

Outline Drawing

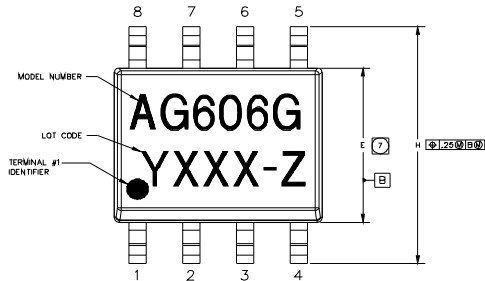

- NOTES:
- EXCEPT WHERE NOTED, THIS PART OUTLINE CONFORMS TO JEDEC STANDARD MS-012, ISSUE C FOR SMALL OUTLINE (SMD) PERIPHERAL TERMINALS 5.25mm BODY WIDTH (PLASTIC).
 - DIMENSIONING & TOLERANCING CONFORM TO ANSI Y14.4M-1994.
 - ALL DIMENSIONS ARE IN MILLIMETERS (INCHES). ANGLES ARE IN DEGREES.
 - DOES NOT INCLUDE MOLD FLASH, PROTRUSIONS OR GATE BURRS, WHICH SHALL NOT EXCEED .15mm(.006in) PER SIDE.
 - DEVIATION FROM JEDEC MS-012 STANDARD.
 - LENGTH OF TERMINAL FOR SOLDERING TO A SUBSTRATE.
 - DOES NOT INCLUDE INTER-LEAD FLASH OR PROTRUSIONS, WHICH SHALL NOT EXCEED .25mm(.010in) PER SIDE.

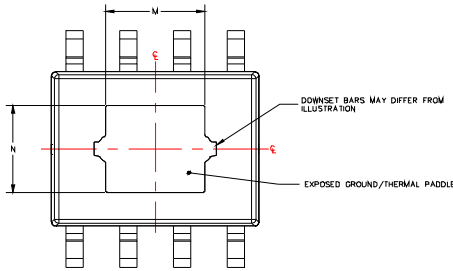
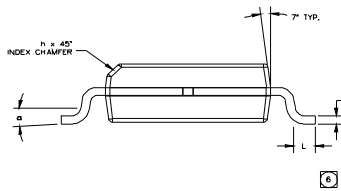
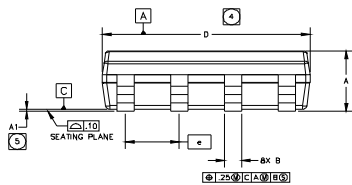

SYMBOL	MILLIMETERS			INCHES		
	MIN	NOM	MAX	MIN	NOM	MAX
A	1.42	1.52	1.62	.056	.060	.064
A1	0	.05	10	0	.002	.004
B	.38	.41	.43	.015	.016	.017
C	.19	.20	.25	.007	.008	.010
D	4.80	4.90	5.00	.189	.193	.197
E	3.80	3.90	4.00	.150	.154	.157
e	1.27 BSC			.050 BSC		
H	5.80	6.0	6.20	.228	.236	.244
h	.25	.33	.50	.01	.013	.02
L	.40	.84	1.27	.016	.033	.050
M	2.21	2.34	2.47	.087	.092	.097
N	2.08	2.21	2.34	.082	.087	.092
o	0	4"	8"	0	4"	8"

Land Pattern

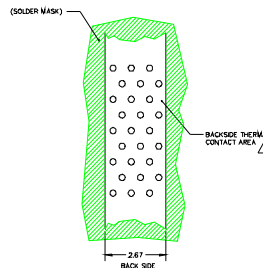
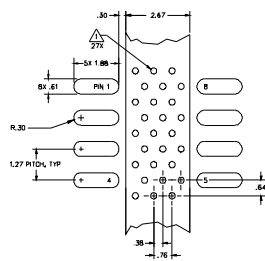
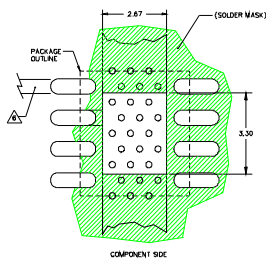

Product Marking

The AG606 will be marked with an "AG606G" designator with a lot code marked below the part designator. The "Y" represents the last digit of the year the part was manufactured, the "XXX" is an auto-generated number, and "Z" refers to a wafer number in a lot batch.

Tape and reel specifications for this part are located on the website in the "Application Notes" section.

ESD / MSL Information

ESD Rating: Class 1C
 Value: 1000 to 2000 V
 Test: Human Body Model (HBM)
 Standard: JEDEC Standard JESD22-A114

ESD Rating: Class IV
 Value: Passes greater than 1000 V
 Test: Charge Device Model (CDM)
 Standard: JEDEC Standard JESD22-C101

MSL Rating: Level 2 at +260 °C convection reflow
 Standard: JEDEC Standard J-STD-020A

Mounting Config. Notes

- Ground / thermal vias are critical for the proper performance of this device. Vias should use a .35mm (#80/.0135") diameter drill and have a final plated through diameter of .25mm (.010")
- Add as much copper as possible to inner and outer layers near the part to ensure optimal thermal performance.
- To ensure reliable operation, device ground paddle-to-ground pad solder joint is critical.
- Add mounting screws near the part to fasten the board to a heatsink. Ensure that the ground / thermal via region contacts the heatsink.
- For optimal thermal performance, expose soldermask on backside where it contacts the heatsink.
- RF trace width depends upon the PC board material and construction.
- Use 1 oz. Copper minimum.
- If the PCB design rules allow, ground vias should be placed under the land pattern for better RF and thermal performance. Otherwise ground vias should be placed as close to the land pattern as possible.
- All dimensions are in mm. Angles are in degrees.

Компания «Океан Электроники» предлагает заключение долгосрочных отношений при поставках импортных электронных компонентов на взаимовыгодных условиях!

Наши преимущества:

- Поставка оригинальных импортных электронных компонентов напрямую с производств Америки, Европы и Азии, а так же с крупнейших складов мира;
- Широкая линейка поставок активных и пассивных импортных электронных компонентов (более 30 млн. наименований);
- Поставка сложных, дефицитных, либо снятых с производства позиций;
- Оперативные сроки поставки под заказ (от 5 рабочих дней);
- Экспресс доставка в любую точку России;
- Помощь Конструкторского Отдела и консультации квалифицированных инженеров;
- Техническая поддержка проекта, помощь в подборе аналогов, поставка прототипов;
- Поставка электронных компонентов под контролем ВП;
- Система менеджмента качества сертифицирована по Международному стандарту ISO 9001;
- При необходимости вся продукция военного и аэрокосмического назначения проходит испытания и сертификацию в лаборатории (по согласованию с заказчиком);
- Поставка специализированных компонентов военного и аэрокосмического уровня качества (Xilinx, Altera, Analog Devices, Intersil, Interpoint, Microsemi, Actel, Aeroflex, Peregrine, VPT, Syfer, Eurofarad, Texas Instruments, MS Kennedy, Miteq, Cobham, E2V, MA-COM, Hittite, Mini-Circuits, General Dynamics и др.);

Компания «Океан Электроники» является официальным дистрибьютором и эксклюзивным представителем в России одного из крупнейших производителей разъемов военного и аэрокосмического назначения «JONHON», а так же официальным дистрибьютором и эксклюзивным представителем в России производителя высокотехнологичных и надежных решений для передачи СВЧ сигналов «FORSTAR».



JONHON

«JONHON» (основан в 1970 г.)

Разъемы специального, военного и аэрокосмического назначения:

(Применяются в военной, авиационной, аэрокосмической, морской, железнодорожной, горно- и нефтедобывающей отраслях промышленности)

«FORSTAR» (основан в 1998 г.)

ВЧ соединители, коаксиальные кабели, кабельные сборки и микроволновые компоненты:

(Применяются в телекоммуникациях гражданского и специального назначения, в средствах связи, РЛС, а так же военной, авиационной и аэрокосмической отраслях промышленности).



Телефон: 8 (812) 309-75-97 (многоканальный)

Факс: 8 (812) 320-03-32

Электронная почта: ocean@oceanchips.ru

Web: <http://oceanchips.ru/>

Адрес: 198099, г. Санкт-Петербург, ул. Калинина, д. 2, корп. 4, лит. А