

MAX44250/MAX44251/MAX44252

20V, Ultra-Precision, Low-Noise Op Amps

General Description

The MAX44250/MAX44251/MAX44252 are 20V, ultra-precision, low-noise, low-drift amplifiers that offer near-zero DC offset and drift through the use of patented auto-correlating zeroing techniques. This method constantly measures and compensates the input offset, eliminating drift over time and temperature and the effect of 1/f noise. These single, dual, and quad devices feature rail-to-rail outputs, operate from a single 2.7V to 20V supply, and consume only 1.15mA per channel, while providing 5.9nV/ $\sqrt{\text{Hz}}$ input-referred voltage noise. The ICs are unity-gain stable with a gain-bandwidth product of 10MHz.

With excellent specifications such as offset voltage of 6 μV (max), drift of 19nV/ $^{\circ}\text{C}$ (max), and 123nV_{P-P} noise in 0.1Hz to 10Hz, the ICs are ideally suited for applications requiring ultra-low noise and DC precision such as interfacing with pressure sensors, strain gauges, precision weight scales, and medical instrumentation.

The ICs are available in 5-pin SOT23, 8-pin SOT23, 8-pin $\mu\text{MAX}^{\text{®}}$, and 14-pin SO packages and are rated over the -40 $^{\circ}\text{C}$ to +125 $^{\circ}\text{C}$ temperature range.

Ordering Information appears at end of data sheet.

Functional Diagrams appear at end of data sheet.

For related parts and recommended products to use with this part, refer to www.maximintegrated.com/MAX44250.related.

Benefits and Features

- ◆ 2.7V to 20V Power-Supply Range
- ◆ Integrated EMI Filter
- ◆ 6 μV Input Offset Voltage (max) at Room Temperature
- ◆ TCV_{OS} of 19nV/ $^{\circ}\text{C}$ (max)
- ◆ Low 5.9nV/ $\sqrt{\text{Hz}}$ Input-Referred Voltage Noise
- ◆ 123nV_{P-P} in 0.1Hz to 10Hz
- ◆ Fast 400ns Settling Time
- ◆ 10MHz Gain-Bandwidth Product
- ◆ Rail-to-Rail Output
- ◆ High Accuracy Enables Precision Signal Chain Acquisition

Applications

Strain Gauges
 Pressure Transducers
 Medical Instrumentation
 Precision Instrumentation
 Load Cell and Bridge Transducer Amplification

Typical Operating Circuit

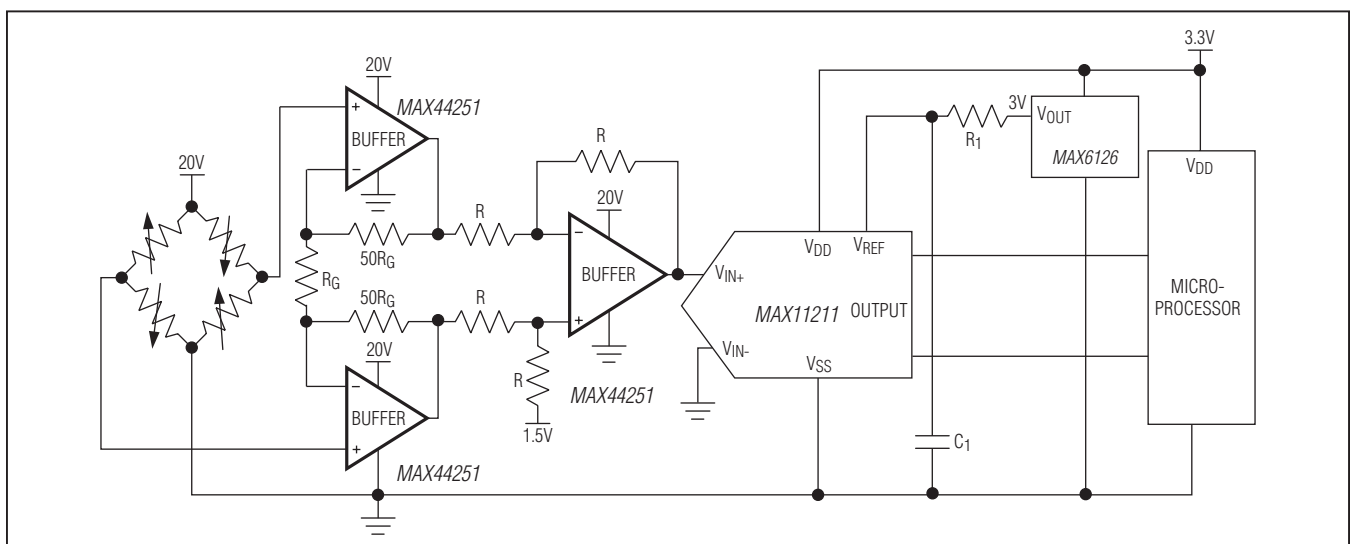

μMAX is a registered trademark of Maxim Integrated Products, Inc.

For pricing, delivery, and ordering information, please contact Maxim Direct at 1-888-629-4642, or visit Maxim's website at www.maximintegrated.com.

MAX44250/MAX44251/MAX44252

20V, Ultra-Precision, Low-Noise Op Amps

ABSOLUTE MAXIMUM RATINGS

| | | | |
|---|--|--|-----------------|
| Supply Voltage (V_{DD} to V_{SS})..... | -0.3V to +22V | μ MAX (derate 4.5 mW/°C above +70°C) | 362mW |
| All Other Pins..... | ($V_{SS} - 0.3V$) to ($V_{DD} + 0.3V$) | SO (derate 8.3 mW/°C above +70°C) | 666.7mW |
| Short-Circuit Duration to Either Supply Rail | 1s | Operating Temperature Range | -40°C to +125°C |
| Continuous Input Current (any pin)..... | ± 20 mA | Junction Temperature | +150°C |
| Differential Input Voltage..... | ± 6 V | Storage Temperature Range..... | -65°C to +150°C |
| Maximum Power Dissipation ($T_A = +70^\circ\text{C}$) | | Lead Temperature (soldering, 10s) | +300°C |
| 5-Pin SOT23 (derate 3.1mW/°C above +70°C)..... | 246.7mW | Soldering Temperature (reflow) | +260°C |
| 8-Pin SOT23 (derate 9.1mW/°C above +70°C) | 727mW | | |

Stresses beyond those listed under "Absolute Maximum Ratings" may cause permanent damage to the device. These are stress ratings only, and functional operation of the device at these or any other conditions beyond those indicated in the operational sections of the specifications is not implied. Exposure to absolute maximum rating conditions for extended periods may affect device reliability.

PACKAGE THERMAL CHARACTERISTICS (Note 1)

| | | | |
|--|-----------|--|---------|
| 5-Pin SOT23 | μ MAX | | |
| Junction-to-Ambient Thermal Resistance (θ_{JA}) | 324.3°C/W | Junction-to-Ambient Thermal Resistance (θ_{JA}) | 221°C/W |
| Junction-to-Case Thermal Resistance (θ_{JC}) | 82°C/W | Junction-to-Case Thermal Resistance (θ_{JC}) | 42°C/W |
| 8-Pin SOT23 | SO | | |
| Junction-to-Ambient Thermal Resistance (θ_{JA}) | 196°C/W | Junction-to-Ambient Thermal Resistance (θ_{JA}) | 120°C/W |
| Junction-to-Case Thermal Resistance (θ_{JC}) | 70°C/W | Junction-to-Case Thermal Resistance (θ_{JC}) | 37°C/W |

Note 1: Package thermal resistances were obtained using the method described in JEDEC specification JESD51-7, using a four-layer board. For detailed information on package thermal considerations, refer to www.maximintegrated.com/thermal-tutorial.

ELECTRICAL CHARACTERISTICS

($V_{DD} = 10V$, $V_{SS} = 0V$, $V_{IN+} = V_{IN-} = V_{DD}/2$, $R_L = 10k\Omega$ to $V_{DD}/2$, $T_A = -40^\circ\text{C}$ to $+125^\circ\text{C}$, unless otherwise noted. Typical values are at $T_A = +25^\circ\text{C}$.) (Note 2)

| PARAMETER | SYMBOL | CONDITIONS | | MIN | TYP | MAX | UNITS |
|---|----------|--|--|-----------------|------|----------------|---------------|
| POWER SUPPLY | | | | | | | |
| Supply Voltage Range | V_{DD} | Guaranteed by PSRR | | 2.7 | | 20 | V |
| Power-Supply Rejection Ratio (Note 3) | PSRR | $V_{DD} = 2.7V$ to $20V$, $V_{CM} = 0V$ | | 140 | 145 | | dB |
| Quiescent Current per Amplifier (MAX44250) | I_{DD} | $R_L = \infty$ | $T_A = +25^\circ\text{C}$ | | 1.22 | 1.7 | mA |
| | | | $-40^\circ\text{C} < T_A < +125^\circ\text{C}$ | | | 1.85 | |
| Quiescent Current per Amplifier (MAX44251/MAX44252) | I_{DD} | $R_L = \infty$ | $T_A = +25^\circ\text{C}$ | | 1.15 | 1.55 | mA |
| | | | $-40^\circ\text{C} < T_A < +125^\circ\text{C}$ | | | 1.75 | |
| Power-Up Time | t_{ON} | | | | 25 | | μs |
| DC SPECIFICATIONS | | | | | | | |
| Input Common-Mode Range | V_{CM} | Guaranteed by CMRR test | | $V_{SS} - 0.05$ | | $V_{DD} - 1.5$ | V |
| Common-Mode Rejection Ratio (Note 3) | CMRR | $T_A = +25^\circ\text{C}$, $V_{CM} = -0.05V$ to ($V_{DD} - 1.5V$) | | 133 | 140 | | dB |
| | | $-40^\circ\text{C} < T_A < +125^\circ\text{C}$ | | 130 | | | |
| Input Offset Voltage (MAX44250) (Note 3) | V_{OS} | $T_A = +25^\circ\text{C}$ | | | 3 | 9 | μV |

MAX44250/MAX44251/MAX44252

20V, Ultra-Precision, Low-Noise Op Amps

ELECTRICAL CHARACTERISTICS (continued)

($V_{DD} = 10V$, $V_{SS} = 0V$, $V_{IN+} = V_{IN-} = V_{DD}/2$, $R_L = 10k\Omega$ to $V_{DD}/2$, $T_A = -40^\circ C$ to $+125^\circ C$, unless otherwise noted. Typical values are at $T_A = +25^\circ C$.) (Note 2)

| PARAMETER | SYMBOL | CONDITIONS | | MIN | TYP | MAX | UNITS |
|--|-------------|---|------------------------------------|-----|------|------|----------------|
| Input Offset Voltage (MAX44251/MAX44252)(Note 3) | V_{OS} | $T_A = +25^\circ C$ | | | 3 | 6 | μV |
| | | $-40^\circ C < T_A < +125^\circ C$ | | | | 7 | |
| Input Offset Voltage Drift (MAX44250) (Note 3) | $TC V_{OS}$ | | | | 5 | 26 | $nV/^\circ C$ |
| Input Offset Voltage Drift (MAX44251/MAX44252)(Note 3) | $TC V_{OS}$ | | | | 5 | 19 | $nV/^\circ C$ |
| Input Bias Current (MAX44250) (Note 3) | I_B | $T_A = +25^\circ C$ | | | 200 | 1400 | μA |
| Input Bias Current (MAX44251/MAX44252)(Note 3) | I_B | $T_A = +25^\circ C$ | | | 200 | 1300 | μA |
| | | $-40^\circ C < T_A < +125^\circ C$ | | | | 2400 | |
| Input Offset Current (Note 3) | I_{OS} | | | | 400 | | μA |
| Open-Loop Gain (Note 3) | A_{VOL} | $250mV \leq V_{OUT} \leq V_{DD} - 250mV$, $R_L = 10k\Omega$ to $V_{DD}/2$ | $T_A = +25^\circ C$ | 145 | 154 | | dB |
| | | | $-40^\circ C < T_A < +125^\circ C$ | 136 | | | |
| Output Short-Circuit Current | | To V_{DD} or V_{SS} | Noncontinuous | | 96 | | mA |
| Output Voltage Low (MAX44250) | V_{OL} | $V_{OUT} - V_{SS}$ | $R_L = 10k\Omega$ to $V_{DD}/2$ | | 12 | 26 | mV |
| | | | $R_L = 2k\Omega$ to $V_{DD}/2$ | | 45 | 92 | |
| Output Voltage Low (MAX44251/MAX44252) | V_{OL} | $V_{OUT} - V_{SS}$ | $R_L = 10k\Omega$ to $V_{DD}/2$ | | 12 | 25 | mV |
| | | | $R_L = 2k\Omega$ to $V_{DD}/2$ | | 45 | 85 | |
| Output Voltage High (MAX44250) | V_{OH} | $V_{DD} - V_{OUT}$ | $R_L = 10k\Omega$ to $V_{DD}/2$ | | 18 | 40 | mV |
| | | | $R_L = 2k\Omega$ to $V_{DD}/2$ | | 71 | 148 | |
| Output Voltage High (MAX44251/MAX44252) | V_{OH} | $V_{DD} - V_{OUT}$ | $R_L = 10k\Omega$ to $V_{DD}/2$ | | 18 | 37 | mV |
| | | | $R_L = 2k\Omega$ to $V_{DD}/2$ | | 71 | 135 | |
| AC SPECIFICATIONS | | | | | | | |
| Input Voltage-Noise Density | e_N | $f = 1kHz$ | | | 5.9 | | nV/\sqrt{Hz} |
| Input Voltage Noise | | $0.1Hz < f < 10Hz$ | | | 123 | | nV_{P-P} |
| Input Current-Noise Density | i_N | $f = 1kHz$ | | | 0.6 | | pA/\sqrt{Hz} |
| Input Capacitance | C_{IN} | | | | 2 | | pF |
| Gain-Bandwidth Product | GBW | | | | 10 | | MHz |
| Phase Margin | PM | $C_L = 20pF$ | | | 60 | | Degrees |
| Slew Rate | SR | $A_V = 1V/V$, $V_{OUT} = 2V_{P-P}$ | | | 8 | | $V/\mu s$ |
| Capacitive Loading | C_L | No sustained oscillation, $A_V = 1V/V$ | | | 500 | | pF |
| Total Harmonic Distortion | THD | $V_{OUT} = 2V_{P-P}$, $A_V = +1V/V$, $R_L = 10k\Omega$ to $V_{DD}/2$ | $f = 1kHz$ | | -124 | | dB |
| | | | $f = 20kHz$ | | -119 | | |
| Settling Time | | To 0.01%, $V_{OUT} = 2V$ step, $A_V = -1V/V$ | | | 400 | | ns |

MAX44250/MAX44251/MAX44252

20V, Ultra-Precision, Low-Noise Op Amps

ELECTRICAL CHARACTERISTICS

($V_{DD} = 3.3V$, $V_{SS} = 0V$, $V_{IN+} = V_{IN-} = V_{DD}/2$, $R_L = 10k\Omega$ to $V_{DD}/2$, $T_A = -40^\circ C$ to $+125^\circ C$, unless otherwise noted. Typical values are at $T_A = +25^\circ C$.) (Note 2)

| PARAMETER | SYMBOL | CONDITIONS | | MIN | TYP | MAX | UNITS |
|--|-------------|---|------------------------------------|-----------------|------|----------------|----------------|
| POWER SUPPLY | | | | | | | |
| Quiescent Current Per Amplifier (MAX44250) | I_{DD} | $R_L = \infty$ | $T_A = +25^\circ C$ | 1.17 | 1.65 | | mA |
| | | | $-40^\circ C < T_A < +125^\circ C$ | | | 1.80 | |
| Quiescent Current Per Amplifier (MAX44251/MAX44252) | I_{DD} | $R_L = \infty$ | $T_A = +25^\circ C$ | 1.1 | 1.5 | | mA |
| | | | $-40^\circ C < T_A < +125^\circ C$ | | | 1.65 | |
| Power-Up Time | t_{ON} | | | 25 | | | μs |
| DC SPECIFICATIONS | | | | | | | |
| Input Common-Mode Range | V_{CM} | Guaranteed by CMRR test | | $V_{SS} - 0.05$ | | $V_{DD} - 1.5$ | V |
| Common-Mode Rejection Ratio (Note 3) | CMRR | $T_A = +25^\circ C$, $V_{CM} = -0.05V$ to $(V_{DD} - 1.5V)$ | | 120 | 129 | | dB |
| | | $-40^\circ C < T_A < +125^\circ C$ | | 117 | | | |
| Input Offset Voltage (MAX44250)(Note 3) | V_{OS} | | | | 3 | 8.5 | μV |
| Input Offset Voltage (MAX44251/MAX44252)(Note 3) | V_{OS} | $T_A = +25^\circ C$ | | | 3 | 5.5 | μV |
| | | $-40^\circ C < T_A < +125^\circ C$ | | | | 6.5 | |
| Input Offset Voltage Drift (MAX44250)(Note 3) | TC V_{OS} | | | | 8 | 25 | nV/ $^\circ C$ |
| Input Offset Voltage Drift (MAX44251/MAX44252)(Note 3) | TC V_{OS} | | | | 8 | 18 | nV/ $^\circ C$ |
| Input Bias Current (MAX44250)(Note 3) | I_B | | | | 200 | 1450 | pA |
| Input Bias Current (MAX44251/MAX44252)(Note 3) | I_B | $T_A = +25^\circ C$ | | | 200 | 1100 | pA |
| | | $-40^\circ C < T_A < +125^\circ C$ | | | | 1200 | |
| Input Offset Current (Note 3) | I_{OS} | | | | 400 | | pA |
| Open-Loop Gain (Note 3) | A_{VOL} | $250mV \leq V_{OUT} \leq V_{DD} - 250mV$, $R_L = 10k\Omega$ to $V_{DD}/2$ | $T_A = +25^\circ C$ | 136 | 151 | | dB |
| | | | $-40^\circ C < T_A < +125^\circ C$ | 133 | | | |
| Output Short-Circuit Current | | To V_{DD} or V_{SS} | Noncontinuous | | 58 | | mA |
| Output Voltage Low (MAX44250) | V_{OL} | $V_{OUT} - V_{SS}$ | $R_L = 10k\Omega$ to $V_{DD}/2$ | | 5 | 26 | mV |
| | | | $R_L = 2k\Omega$ to $V_{DD}/2$ | | 17 | 46 | |
| Output Voltage Low (MAX44251/MAX44252) | V_{OL} | $V_{OUT} - V_{SS}$ | $R_L = 10k\Omega$ to $V_{DD}/2$ | | 5 | 22 | mV |
| | | | $R_L = 2k\Omega$ to $V_{DD}/2$ | | 17 | 42 | |
| Output Voltage High | V_{OH} | $V_{DD} - V_{OUT}$ | $R_L = 10k\Omega$ to $V_{DD}/2$ | | 9 | 22 | mV |
| | | | $R_L = 2k\Omega$ to $V_{DD}/2$ | | 29 | 52 | |

MAX44250/MAX44251/MAX44252

20V, Ultra-Precision, Low-Noise Op Amps

ELECTRICAL CHARACTERISTICS (continued)

($V_{DD} = 3.3V$, $V_{SS} = 0V$, $V_{IN+} = V_{IN-} = V_{DD}/2$, $R_L = 10k\Omega$ to $V_{DD}/2$, $T_A = -40^\circ C$ to $+125^\circ C$, unless otherwise noted. Typical values are at $T_A = +25^\circ C$.) (Note 2)

| PARAMETER | SYMBOL | CONDITIONS | MIN | TYP | MAX | UNITS |
|-----------------------------|----------|--|-------------|-----|------|----------------|
| AC SPECIFICATIONS | | | | | | |
| Input Voltage-Noise Density | e_N | $f = 1kHz$ | | 6.2 | | nV/\sqrt{Hz} |
| Input Voltage Noise | | $0.1Hz < f < 10Hz$ | | 123 | | nV_{P-P} |
| Input Current-Noise Density | i_N | $f = 1kHz$ | | 0.3 | | pA/\sqrt{Hz} |
| Input Capacitance | C_{IN} | | | 2 | | pF |
| Gain-Bandwidth Product | GBW | | | 10 | | MHz |
| Phase Margin | PM | $C_L = 20pF$ | | 60 | | Degrees |
| Slew Rate | SR | $A_V = 1V/V$, $V_{OUT} = 1V_{P-P}$, 10% to 90% | | 5 | | $V/\mu s$ |
| Capacitive Loading | C_L | No sustained oscillation, $A_V = 1V/V$ | | 500 | | pF |
| Total Harmonic Distortion | THD | $V_{OUT} = 1V_{P-P}$, $A_V = +1V/V$, $V_{CM} = V_{DD}/4$, $R_L = 10k\Omega$ to $V_{DD}/2$ | $f = 1kHz$ | | -124 | dB |
| | | | $f = 20kHz$ | | -100 | |
| Settling Time | | To 0.01%, $V_{OUT} = 1V$ step, $A_V = -1V/V$ | | 200 | | ns |

Note 2: All devices are 100% production tested at $T_A = +25^\circ C$. Temperature limits are guaranteed by design.

Note 3: Guaranteed by design.

Typical Operating Characteristics

($V_{DD} = 10V$, $V_{SS} = 0V$, outputs have $R_L = 10k\Omega$ to $V_{DD}/2$. $T_A = +25^\circ C$, unless otherwise specified.)

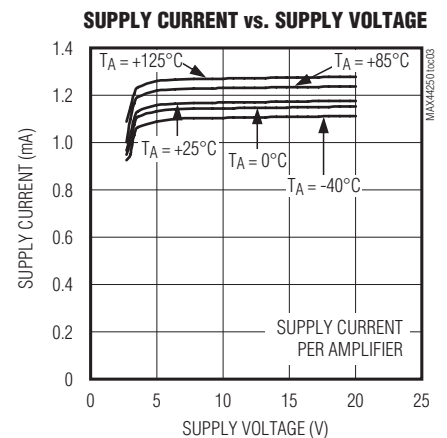
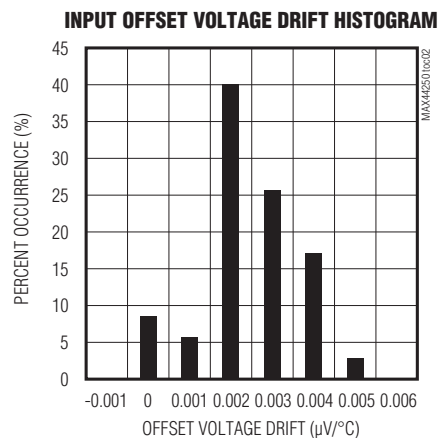
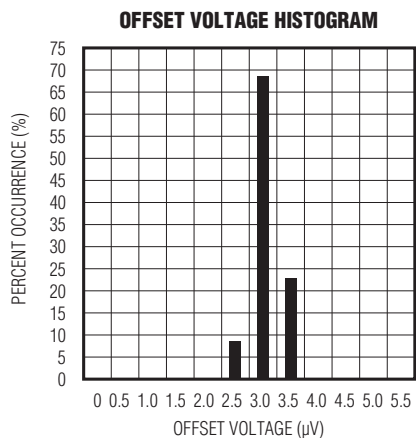

MAX44250/MAX44251/MAX44252

20V, Ultra-Precision, Low-Noise Op Amps

Typical Operating Characteristics (continued)

($V_{DD} = 10V$, $V_{SS} = 0V$, outputs have $R_L = 10k\Omega$ to $V_{DD}/2$. $T_A = +25^\circ C$, unless otherwise specified.)

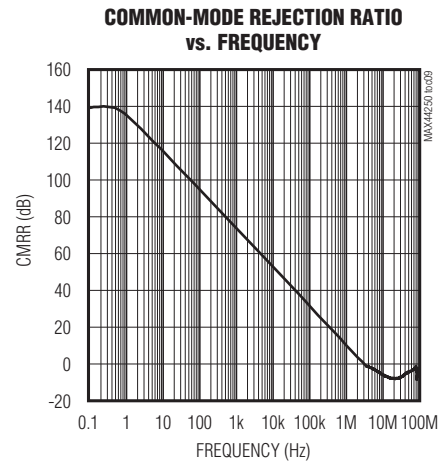
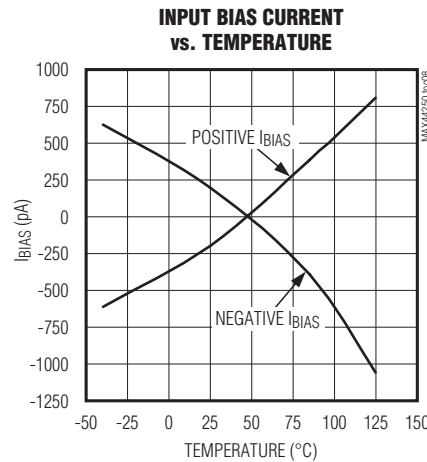
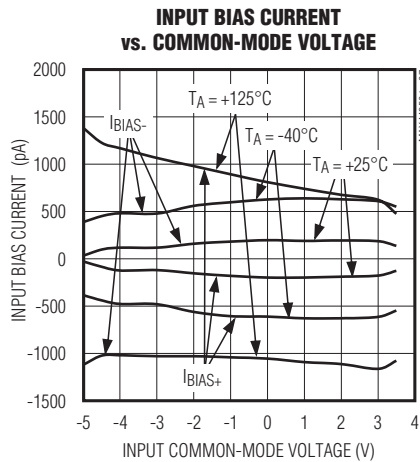
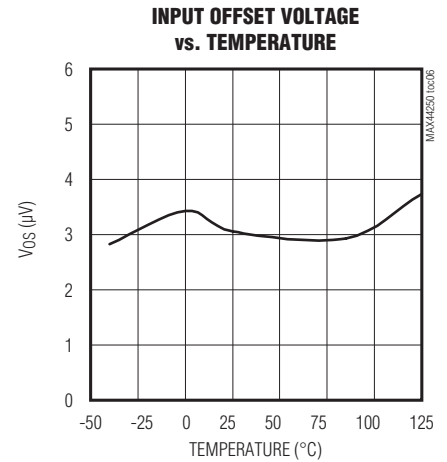
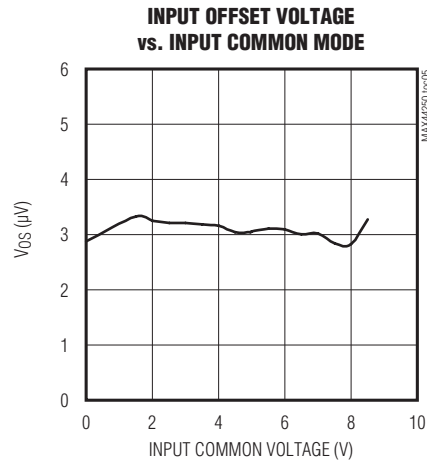
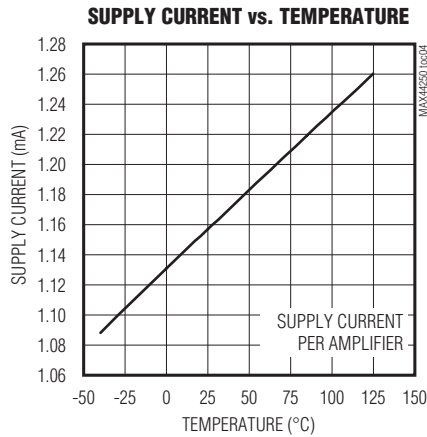

MAX44250/MAX44251/MAX44252

20V, Ultra-Precision, Low-Noise Op Amps

Typical Operating Characteristics (continued)

($V_{DD} = 10V$, $V_{SS} = 0V$, outputs have $R_L = 10k\Omega$ to $V_{DD}/2$. $T_A = +25^\circ C$, unless otherwise specified.)

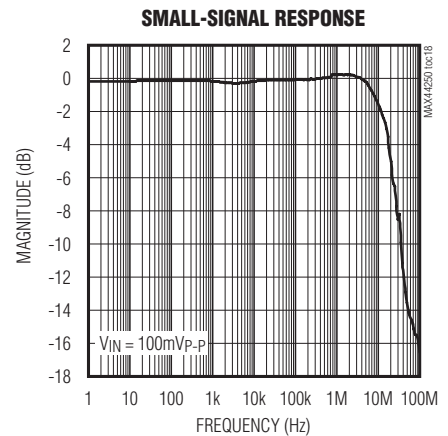
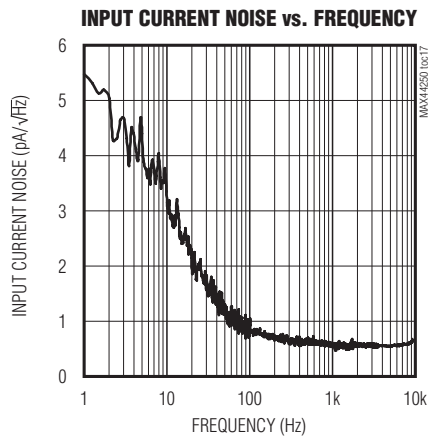
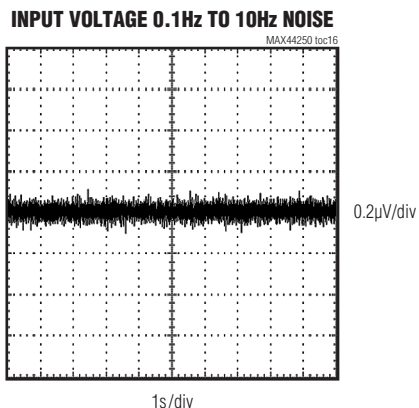
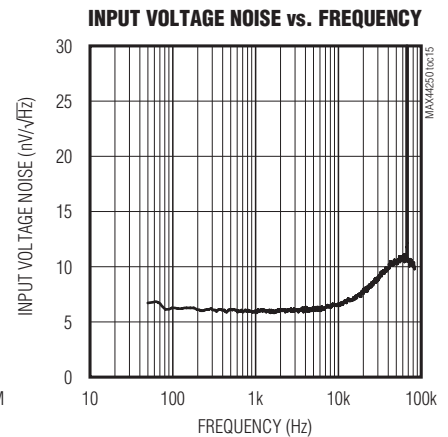
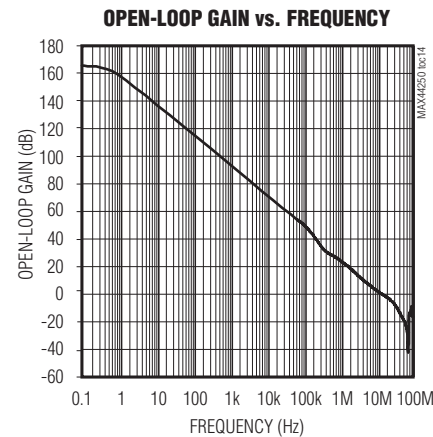
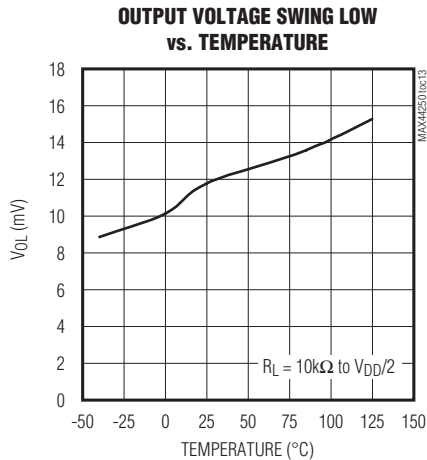
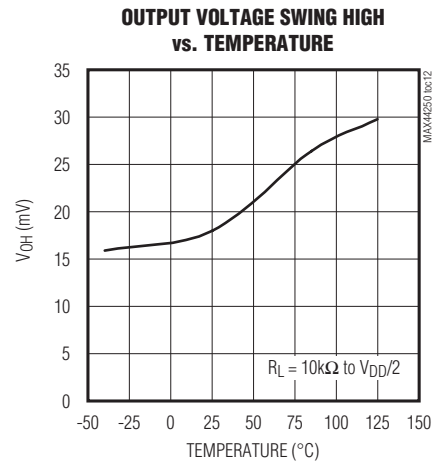
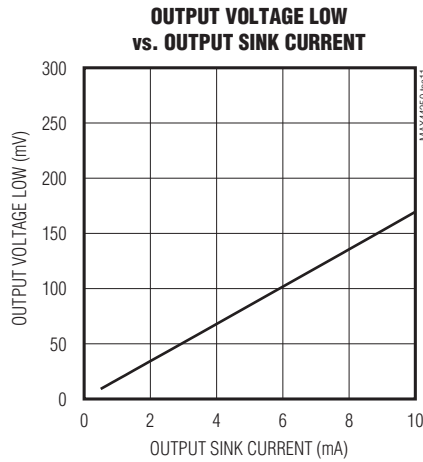
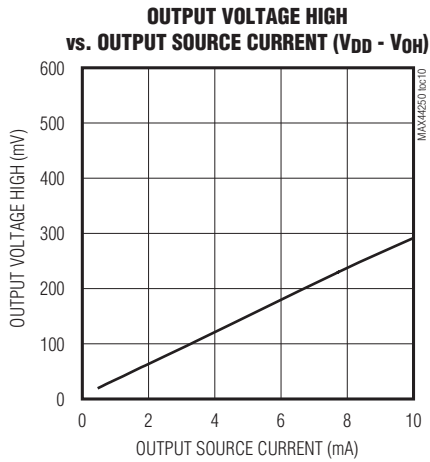

MAX44250/MAX44251/MAX44252

20V, Ultra-Precision, Low-Noise Op Amps

Typical Operating Characteristics (continued)

($V_{DD} = 10V$, $V_{SS} = 0V$, outputs have $R_L = 10k\Omega$ to $V_{DD}/2$. $T_A = +25^\circ C$, unless otherwise specified.)

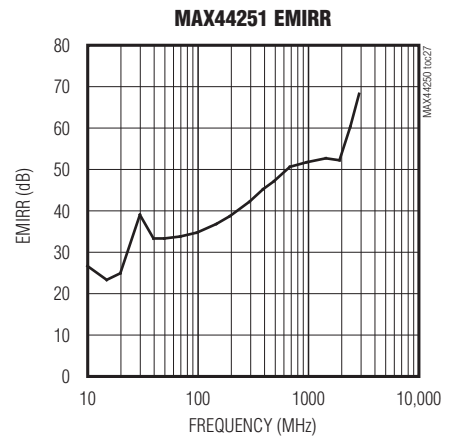
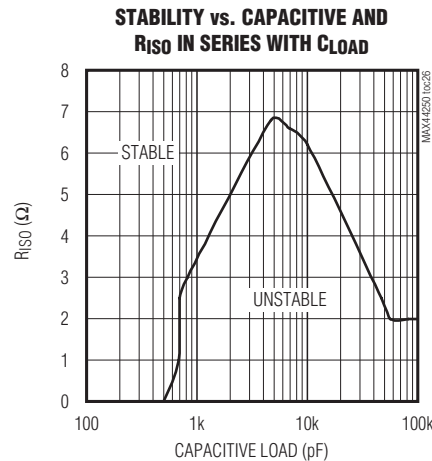
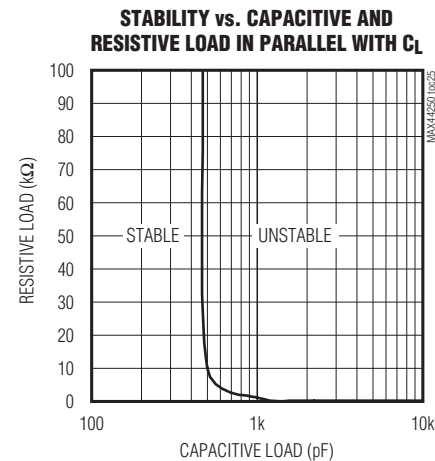
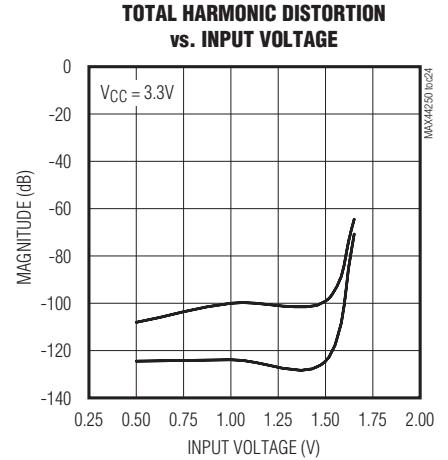
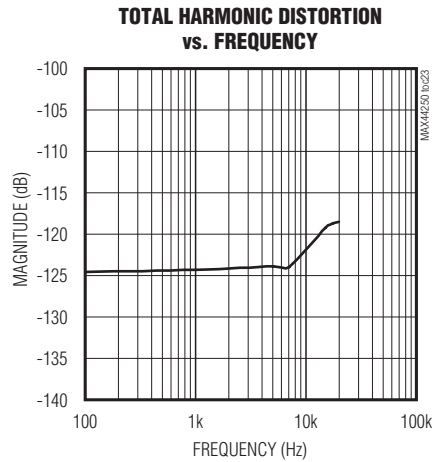
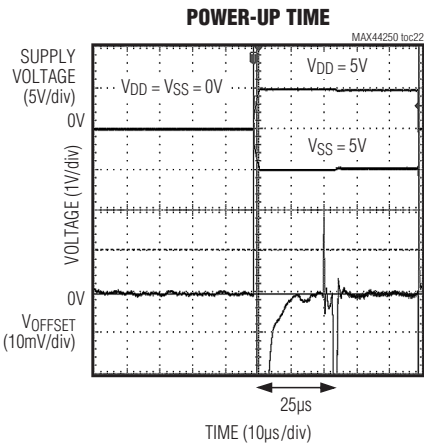
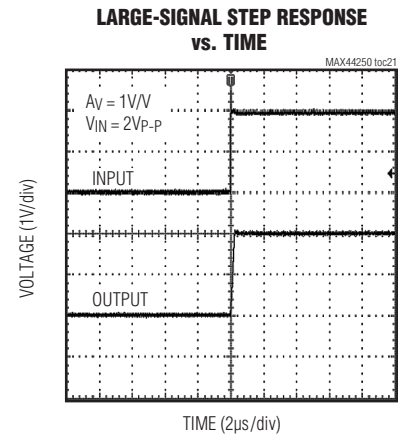
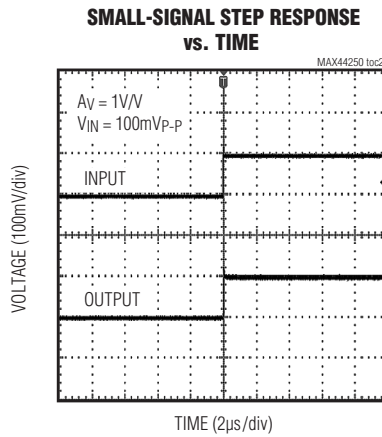
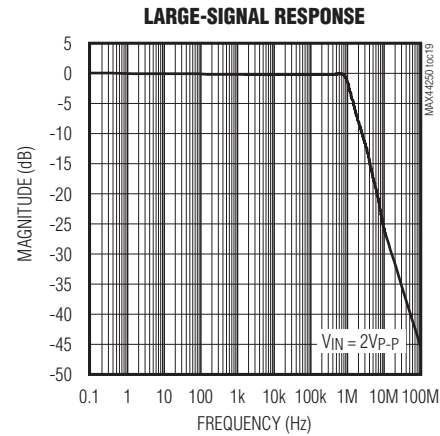

MAX44250/MAX44251/MAX44252

20V, Ultra-Precision, Low-Noise Op Amps

Pin Configurations

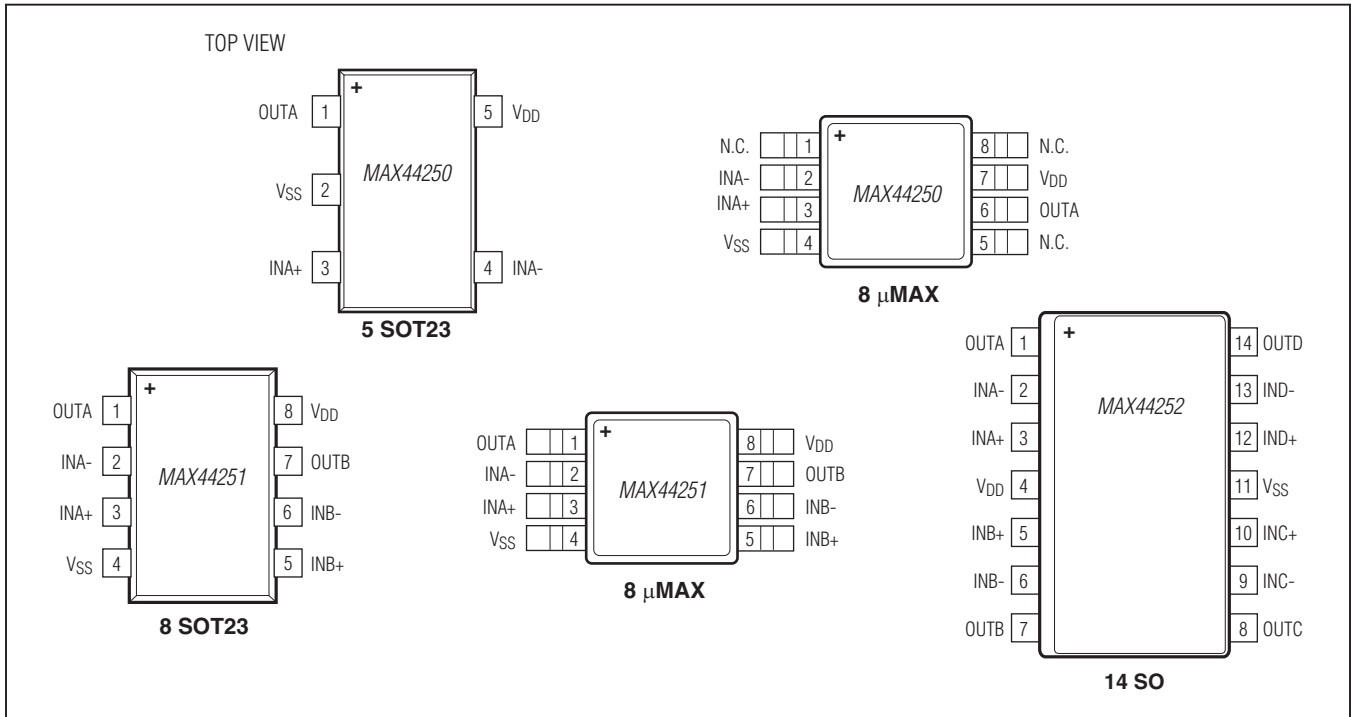

Pin Description

| PIN | | | | | NAME | FUNCTION |
|----------|---------|----------|--------|----------|-----------------|--------------------------|
| MAX44250 | | MAX44251 | | MAX44252 | | |
| 5 SOT23 | 8 μMAX | 8 SOT23 | 8 μMAX | 14 SO | | |
| 1 | 6 | 1 | 1 | 1 | OUTA | Channel A Output |
| 4 | 2 | 2 | 2 | 2 | INA- | Channel A Negative Input |
| 3 | 3 | 3 | 3 | 3 | INA+ | Channel A Positive Input |
| 2 | 4 | 4 | 4 | 11 | V _{SS} | Negative Supply Voltage |
| — | — | 5 | 5 | 5 | INB+ | Channel B Positive Input |
| — | — | 6 | 6 | 6 | INB- | Channel B Negative Input |
| — | — | 7 | 7 | 7 | OUTB | Channel B Output |
| 5 | 7 | 8 | 8 | 4 | V _{DD} | Positive Supply Voltage |
| — | — | — | — | 8 | OUTC | Channel C Output |
| — | — | — | — | 9 | INC- | Channel C Negative Input |
| — | — | — | — | 10 | INC+ | Channel C Positive Input |
| — | — | — | — | 12 | IND+ | Channel D Positive Input |
| — | — | — | — | 13 | IND- | Channel D Negative Input |
| — | — | — | — | 14 | OUTD | Channel D Output |
| — | 1, 5, 8 | — | — | — | N.C. | No Connection |

MAX44250/MAX44251/MAX44252

20V, Ultra-Precision, Low-Noise Op Amps

Detailed Description

The MAX44250/MAX44251/MAX44252 are high-precision amplifiers that have less than $3\mu\text{V}$ of typical input-referred offset and low flicker noise. These characteristics are achieved through an autozeroing technique that samples and finds repeating patterns of signal to cancel the input offset voltage and $1/f$ noise of the amplifier.

Autozero

The ICs feature an autozero circuit that allows the devices to achieve less than $6\mu\text{V}$ (max) of input offset voltage at room temperature and eliminate the $1/f$ noise.

Noise Suppression

Flicker noise, inherent in all active devices, is inversely proportional to frequency presented. Charges at the oxide-silicon interface that are trapped-and-released by MOSFET oxide occurs at low frequency more often. For this reason, flicker noise is also called $1/f$ noise.

Electromagnetic interference (EMI) noise occurs at higher frequency that results in malfunction or degradation of electrical equipment.

The ICs have an input EMI filter to avoid the output getting affected by radio frequency interference. The EMI filter composed of passive devices presents significant higher impedance to higher frequency.

High Supply Voltage Range

The ICs feature 1.15mA current consumption per channel and a voltage supply range from either 2.7V to 20V single supply or $\pm 1.35\text{V}$ to $\pm 10\text{V}$ split supply.

Applications Information

The ICs are ultra-high-precision operational amplifiers with a high supply voltage range designed for load cell, medical instrumentation and precision instrument applications.

These devices are also designed to interface with pressure transducers and are ideal for precision weight scale application as shown in [Figure 1](#).

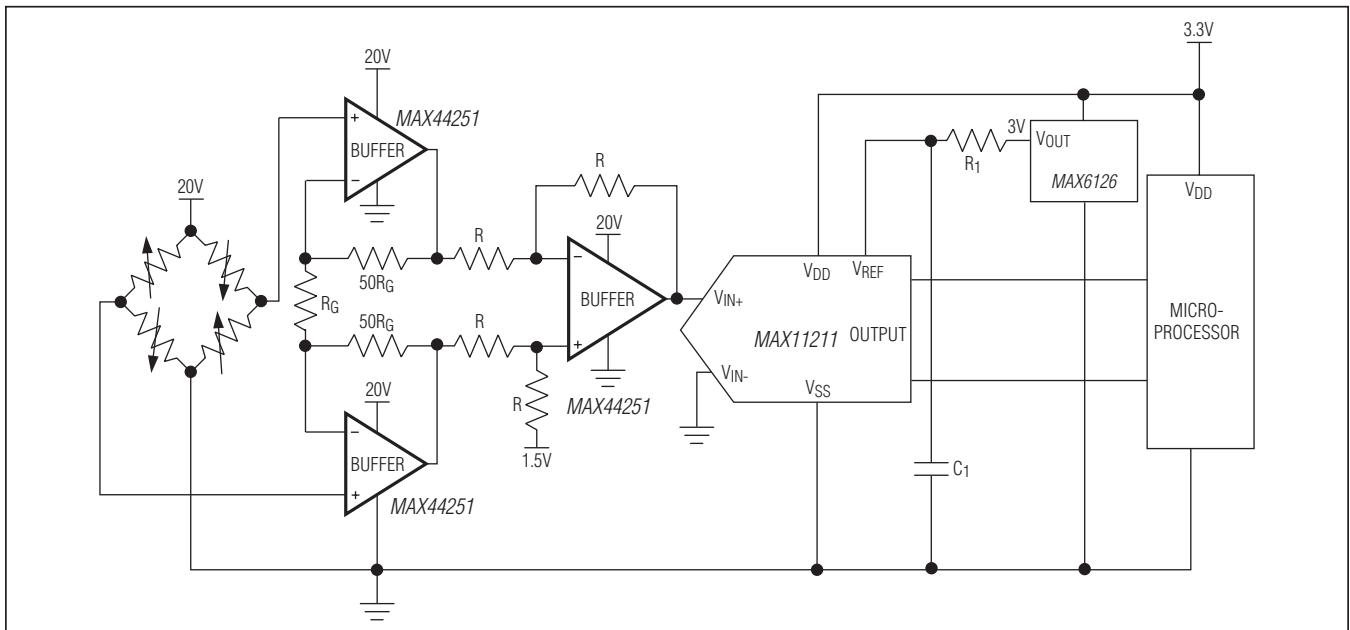

Figure 1. Weight Scale Application Circuit

MAX44250/MAX44251/MAX44252

20V, Ultra-Precision, Low-Noise Op Amps

ADC Buffer Amplifier

The MAX44250/MAX44251/MAX44252's low input offset voltage, low noise, and fast settling time make these amplifiers ideal for ADC buffers. Weigh scales are one application that often require a low-noise, high-voltage amplifier in front of an ADC. [Figure 1](#) details an example of a load cell and amplifier driven from the same $\pm 10\text{V}$ supplies, along with the MAX11211 18-bit delta sigma ADC. Load cells produce a very small voltage change at their outputs, therefore driving the excitation source with a higher voltage produces a wider dynamic range that can be measured at the ADC inputs.

The MAX11211 ADC operates from a single 2.7V to 3.6V analog supply, offers 18-bit noise-free resolution and 0.86mW power dissipation. The MAX11211 also offers > 100dB rejection at 50Hz and 60Hz. This ADC is part of a family of 16-, 18-, 20-, and 24-bit delta sigma ADCs with high precision and < 1mW power dissipation.

The MAX44250/MAX44251/MAX44252's low input offset voltage and low noise allow a gain circuit prior to the MAX11211 without losing any dynamic range at the ADC.

Error Budget Example

When using the ICs as an ADC buffer in strain gauge application, the temperature drift should be taken into consideration to determine maximum input signal. A typical strain gauge has sensitivity specification of just 2mV/V at rated out load. This means that when the strain gauge load cell is powered with 10V, the full-scale output voltage is 20mV. In this application, both offset voltage and drift are critical parameters that directly affect the accuracy of measurement. Even though offset voltage could be calibrated out, its drift over temperature is still a problem.

The ICs, with a typical offset drift of 5nV/°C, guarantee that the drift over a 10°C range is only 50nV. Setting this equal to 0.5 LSB in a 18-bit system yields a full-scale range of 13mV. With a single 10V supply, an acceptable closed-loop gain of 770V/V provides sufficient gain while maintaining headroom.

Precision Low-Side Current Sensing

The ICs' autozero feature produces ultra-low offset voltage and drift, making them ideal for precision current-sensing applications. [Figure 2](#) shows the ICs in a low-side current-sense configuration. This circuit produces an accurate output voltage, V_{OUT} equal to $I_{\text{LOAD}} \times R_{\text{SENSE}} \times (1 + R_2/R_1)$.

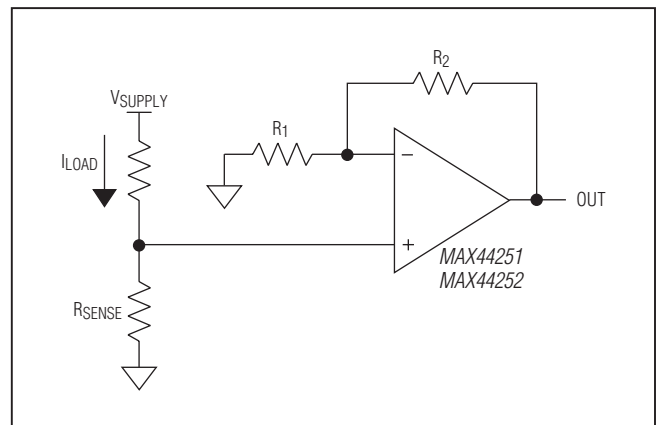
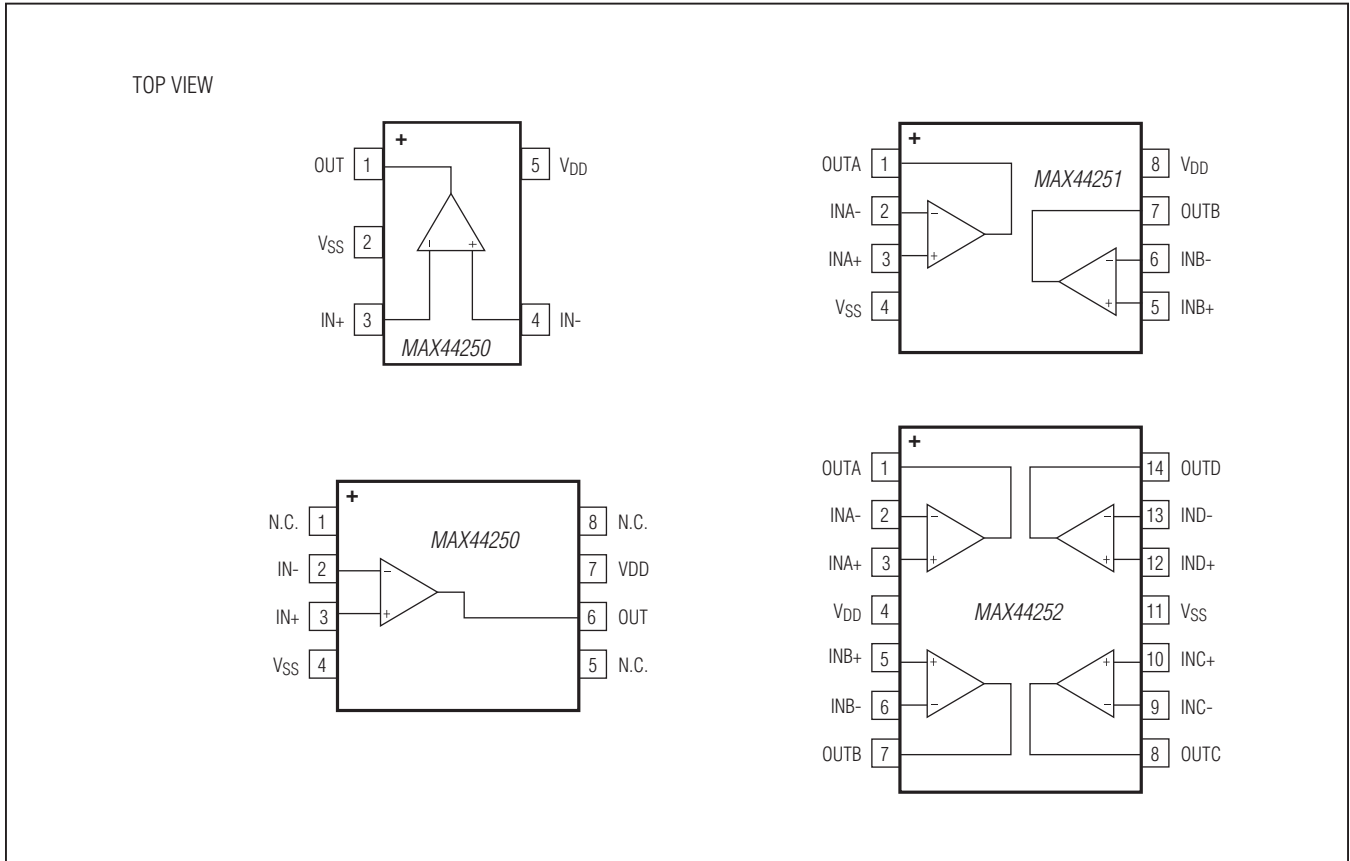

Figure 2. Low-Side Current Sensing

MAX44250/MAX44251/MAX44252

20V, Ultra-Precision, Low-Noise Op Amps

Functional Diagrams



Chip Information

PROCESS: BiCMOS

Ordering Information

| PART | TEMP RANGE | PIN-PACKAGE | TOP MARK |
|----------------------|-----------------|-------------|----------|
| MAX44250 AUK+ | -40°C to +125°C | 5 SOT23 | AFMA |
| MAX44250AUA+ | -40°C to +125°C | 8 μ MAX | — |
| MAX44251 AKA+ | -40°C to +125°C | 8 SOT23 | AERC |
| MAX44251AUA+ | -40°C to +125°C | 8 μ MAX | — |
| MAX44252 ASD+ | -40°C to +125°C | 14 SO | — |

+Denotes a lead(Pb)-free/RoHS-compliant package.

MAX44250/MAX44251/MAX44252

20V, Ultra-Precision, Low-Noise Op Amps

Package Information

For the latest package outline information and land patterns (footprints), go to www.maximintegrated.com/packages. Note that a "+", "#", or "-" in the package code indicates RoHS status only. Package drawings may show a different suffix character, but the drawing pertains to the package regardless of RoHS status.

| PACKAGE TYPE | PACKAGE CODE | OUTLINE NO. | LAND PATTERN |
|--------------|--------------|-------------------------|-------------------------|
| 5 SOT23 | U5+1 | 21-0057 | 90-0174 |
| 8 SOT23 | K8+5 | 21-0078 | 90-0176 |
| 8 μ MAX | U8+1 | 21-0036 | 90-0092 |
| 14 SO | S14M+5 | 21-0041 | 90-0096 |

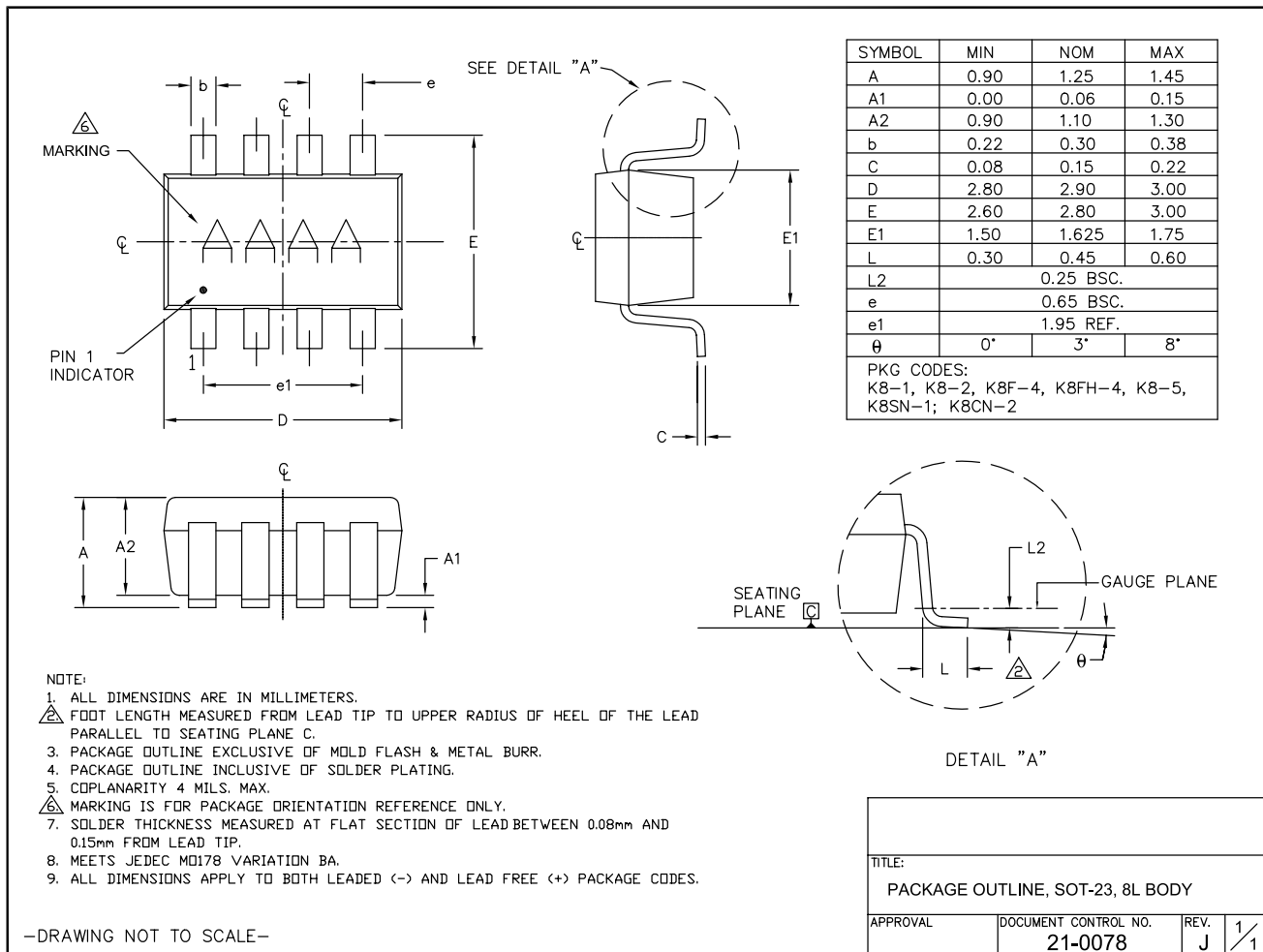

MAX44250/MAX44251/MAX44252

20V, Ultra-Precision, Low-Noise Op Amps

Package Information (continued)

For the latest package outline information and land patterns (footprints), go to www.maximintegrated.com/packages. Note that a "+", "#", or "-" in the package code indicates RoHS status only. Package drawings may show a different suffix character, but the drawing pertains to the package regardless of RoHS status.

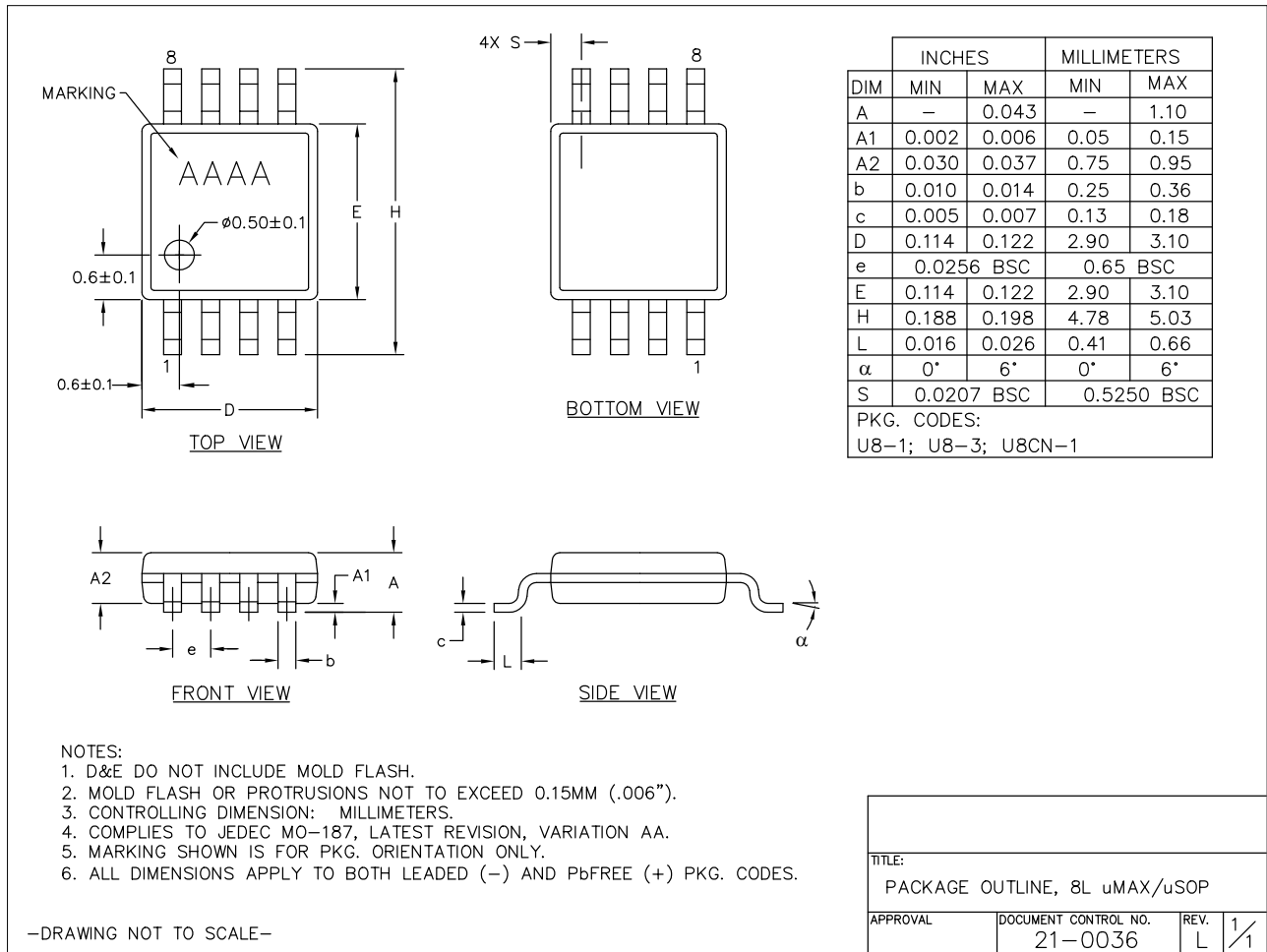

MAX44250/MAX44251/MAX44252

20V, Ultra-Precision, Low-Noise Op Amps

Package Information (continued)

For the latest package outline information and land patterns (footprints), go to www.maximintegrated.com/packages. Note that a "+", "#", or "-" in the package code indicates RoHS status only. Package drawings may show a different suffix character, but the drawing pertains to the package regardless of RoHS status.

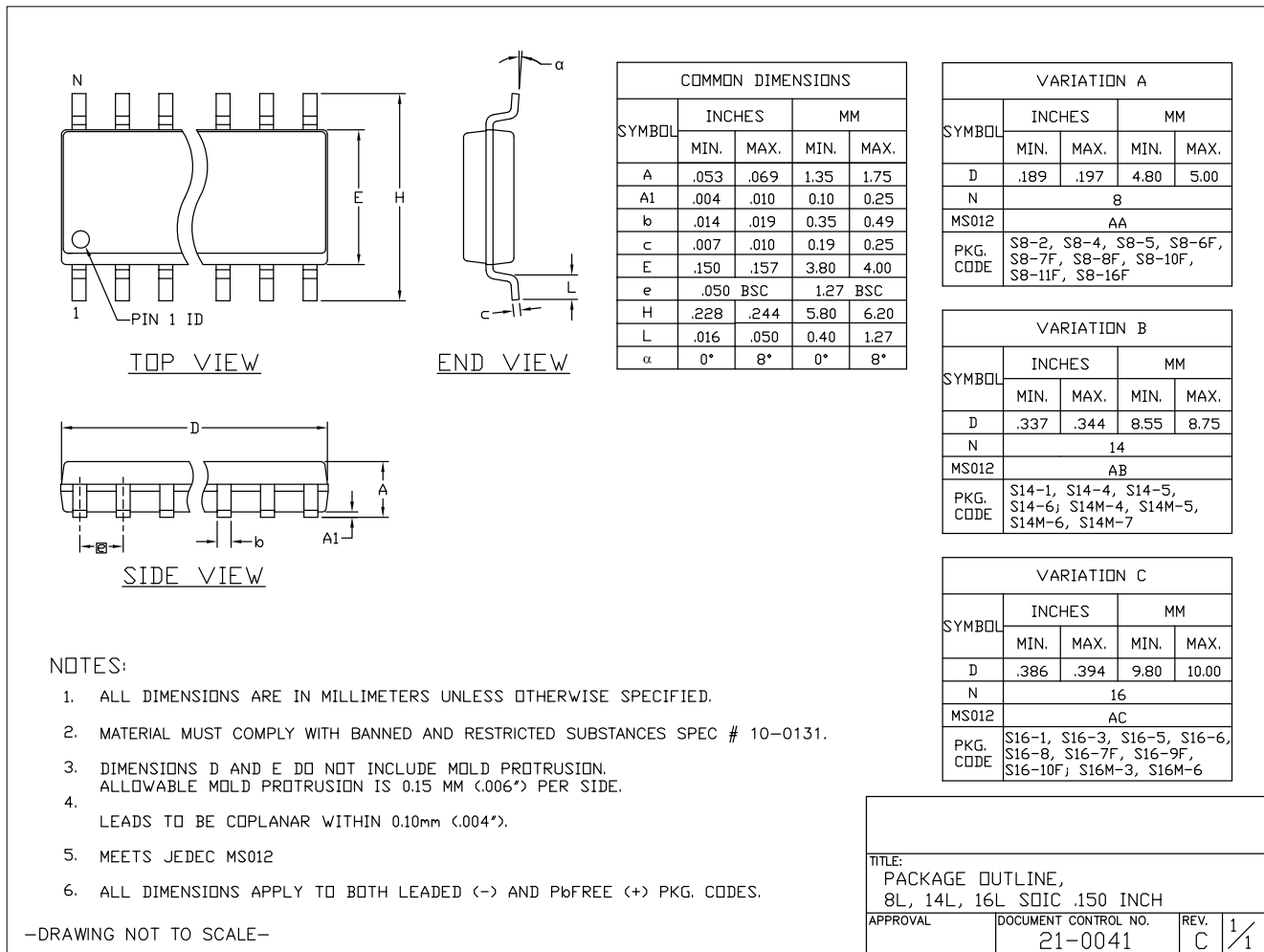

MAX44250/MAX44251/MAX44252

20V, Ultra-Precision, Low-Noise Op Amps

Package Information (continued)

For the latest package outline information and land patterns (footprints), go to www.maximintegrated.com/packages. Note that a "+", "#", or "-" in the package code indicates RoHS status only. Package drawings may show a different suffix character, but the drawing pertains to the package regardless of RoHS status.

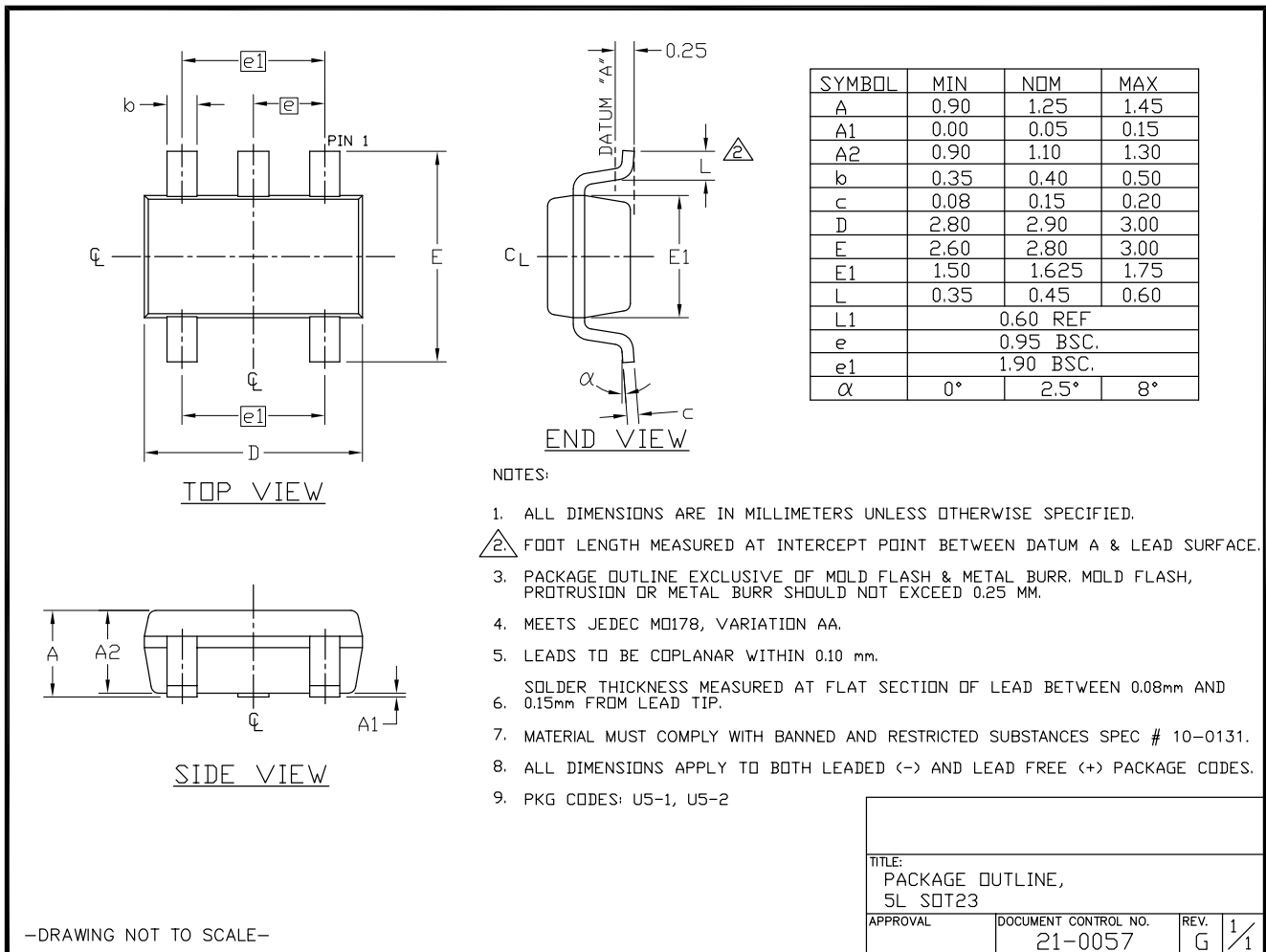

MAX44250/MAX44251/MAX44252

20V, Ultra-Precision, Low-Noise Op Amps

Revision History

| REVISION NUMBER | REVISION DATE | DESCRIPTION | PAGES CHANGED |
|-----------------|---------------|--|---------------|
| 0 | 10/11 | Initial release | — |
| 1 | 12/11 | Released the MAX44252 and updated the <i>Typical Operating Characteristics</i> . | 5, 6, 11 |
| 2 | 8/12 | Added the MAX44250 to the data sheet, added MAX44251 EMIRR graph to <i>Typical Operating Characteristics</i> , and revised Figure 2. | 1–16 |



Maxim cannot assume responsibility for use of any circuitry other than circuitry entirely embodied in a Maxim product. No circuit patent licenses are implied. Maxim reserves the right to change the circuitry and specifications without notice at any time. The parametric values (min and max limits) shown in the Electrical Characteristics table are guaranteed. Other parametric values quoted in this data sheet are provided for guidance.

Maxim Integrated 160 Rio Robles, San Jose, CA 95134 USA 1-408-601-1000

17

Компания «Океан Электроники» предлагает заключение долгосрочных отношений при поставках импортных электронных компонентов на взаимовыгодных условиях!

Наши преимущества:

- Поставка оригинальных импортных электронных компонентов напрямую с производств Америки, Европы и Азии, а так же с крупнейших складов мира;
- Широкая линейка поставок активных и пассивных импортных электронных компонентов (более 30 млн. наименований);
- Поставка сложных, дефицитных, либо снятых с производства позиций;
- Оперативные сроки поставки под заказ (от 5 рабочих дней);
- Экспресс доставка в любую точку России;
- Помощь Конструкторского Отдела и консультации квалифицированных инженеров;
- Техническая поддержка проекта, помощь в подборе аналогов, поставка прототипов;
- Поставка электронных компонентов под контролем ВП;
- Система менеджмента качества сертифицирована по Международному стандарту ISO 9001;
- При необходимости вся продукция военного и аэрокосмического назначения проходит испытания и сертификацию в лаборатории (по согласованию с заказчиком);
- Поставка специализированных компонентов военного и аэрокосмического уровня качества (Xilinx, Altera, Analog Devices, Intersil, Interpoint, Microsemi, Actel, Aeroflex, Peregrine, VPT, Syfer, Eurofarad, Texas Instruments, MS Kennedy, Miteq, Cobham, E2V, MA-COM, Hittite, Mini-Circuits, General Dynamics и др.);

Компания «Океан Электроники» является официальным дистрибьютором и эксклюзивным представителем в России одного из крупнейших производителей разъемов военного и аэрокосмического назначения «JONHON», а так же официальным дистрибьютором и эксклюзивным представителем в России производителя высокотехнологичных и надежных решений для передачи СВЧ сигналов «FORSTAR».



JONHON

«JONHON» (основан в 1970 г.)

Разъемы специального, военного и аэрокосмического назначения:

(Применяются в военной, авиационной, аэрокосмической, морской, железнодорожной, горно- и нефтедобывающей отраслях промышленности)

«FORSTAR» (основан в 1998 г.)

ВЧ соединители, коаксиальные кабели,
кабельные сборки и микроволновые компоненты:

(Применяются в телекоммуникациях гражданского и специального назначения, в средствах связи, РЛС, а так же военной, авиационной и аэрокосмической отраслях промышленности).



Телефон: 8 (812) 309-75-97 (многоканальный)

Факс: 8 (812) 320-03-32

Электронная почта: ocean@oceanchips.ru

Web: <http://oceanchips.ru/>

Адрес: 198099, г. Санкт-Петербург, ул. Калинина, д. 2, корп. 4, лит. А