

EA2804QJ-T and EA2804QJ-T0435 User's Guide

5V/3.4A Dual Cell Backup Battery Power Manager

Description

This document supports both the **EA2804QJ-T** and the **EA2804QJ-T0435** Evaluation Kits. These kits are a proven application-circuit design for the ACT2804QJ-T and ACT2804QJ-T0435 dual cell chargers with power path and single USB outputs. The EVKs contain a single micro-USB input and USB output. They provide two outputs, one at 2.4A and one at 1A. They are configured to charge a 2S Lithium-ion battery with 1.0A. The EVKs operate with very high charge efficiency of 91% and discharge efficiency of 92%. EVKs are identical except for the IC. The ACT2804QJ-T EOC (end of charge voltage) is 4.2V per cell (8.4V total) while the ACT2804QJ-T0435 EOC is 4.35V for each cell (8.7V total).

Features

The EVK contains a high efficiency Buck and Boost DC/DC converter that operates either in CV (Constant Voltage) mode or CC (Constant Current) mode. The EVK provides up to 3.4A output current at 400 kHz switching frequency. It operates from VIN=4.5V to 5.5V and provides an output voltage of 5V. Gerber files are available to minimize time-to-market for applications that want to use the EVK as an end-product.

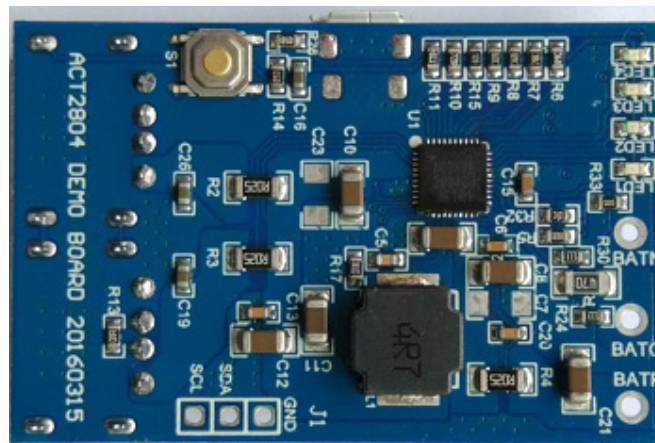

Figure 1 – EVK Picture - Top

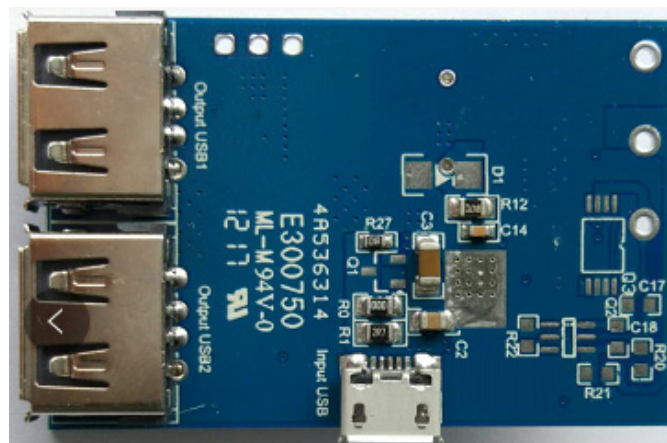

Figure 2 – EVK Picture - Bottom

Setup

Required Equipment

EA2804QJ-T EVK

Power supply – 5V @ 4A for full power operation

Oscilloscope – >100MHz, >2 channels

Loads –Electronic/resistive load with 3.5A minimum current capability.

Digital Multimeter (DMM)

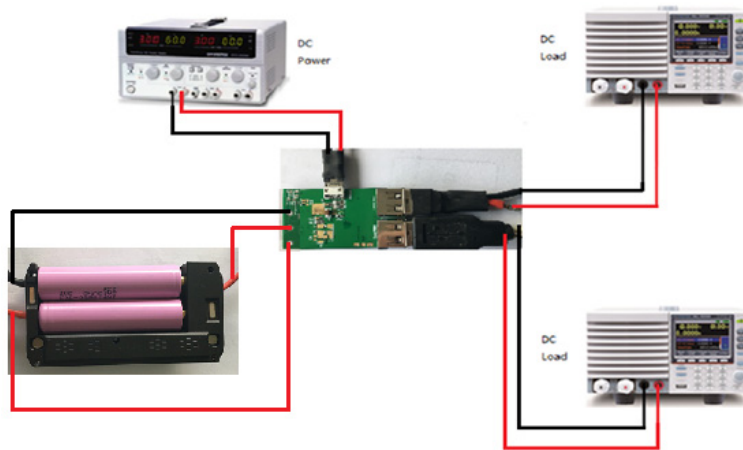

EVK Setup

Hardware Setup

1. Connect a DC power supply to the input USB connector.
2. Connect the EVK outputs to two electronic loads using the two USB connectors.
3. Connect batteries to the BATP, BATC, and BATN pins.

Table 1. Recommended Operating Conditions

Parameter	Description	Min	Typ	Max	Unit
VIN	All buck input voltages	4.5	5	5.5	V
IOUT	Maximum load current		3.4		A

EVK Operation

Turn on

Apply 5V to the input USB connector.

PCB Layout

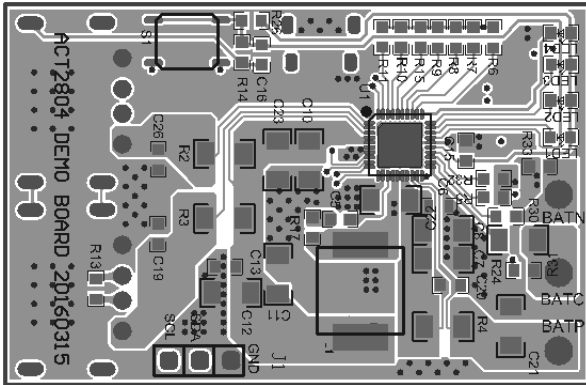

Top Layer

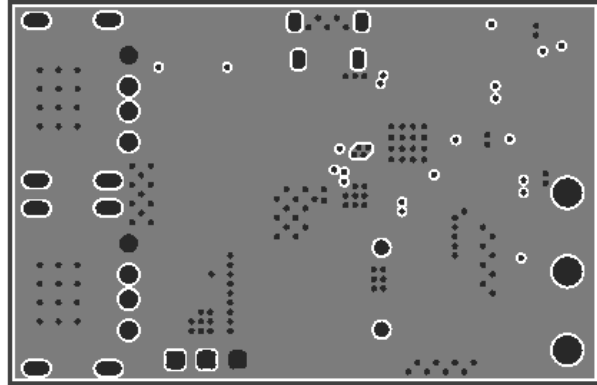

Middle 1 Layer

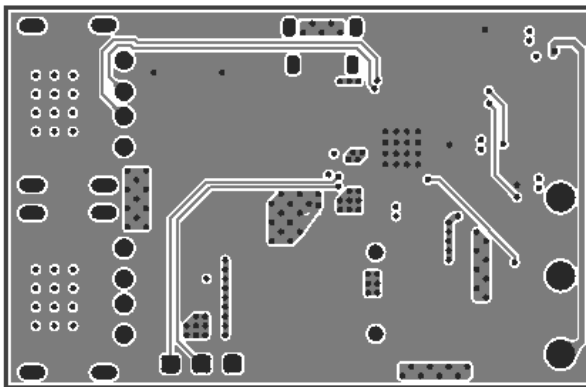

Middle 2 Layer

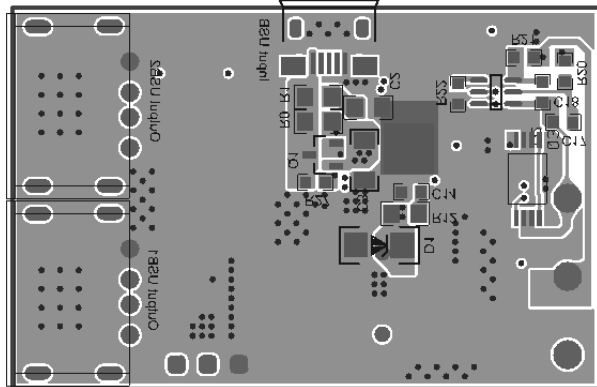

Bottom Layer

Test Results

Power Path Function

(Test condition: $V_{in}=5\text{ V}$, $V_{bat}=7.0\text{V}$, input current limit=3.8A, fast charge current=1.0A)

Input Current(mA)	1467	1679	1977	2264	2481	2697	2991	3258	3450	3463	3455	3470	2743
Output Current(mA)	0	200	500	800	1000	1200	1500	1800	1950	2000	2200	2600	2728
Charge Current(mA)	1015	1012	1010	1009	1007	1006	1012	1009	1002	973	840	583	0

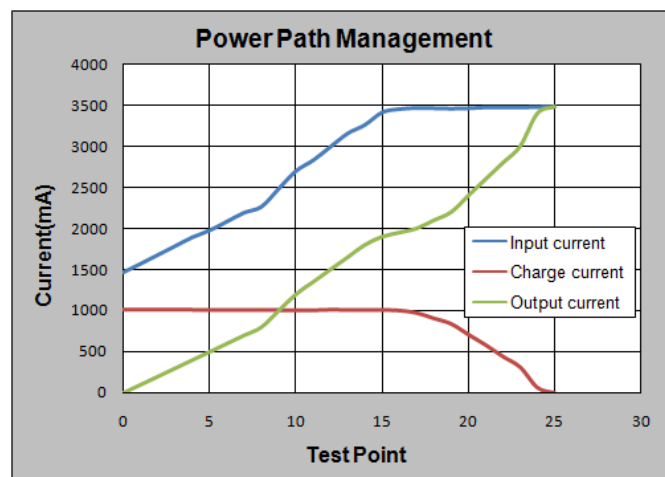

Charge Efficiency

($V_{in}=5\text{V}$ and charge current set at 1000mA)

Battery voltage (V)	6.0	6.5	7.0	7.5	8.0	8.2
Efficiency (%)	95.9	95.3	94.1	93.1	92.1	91.7

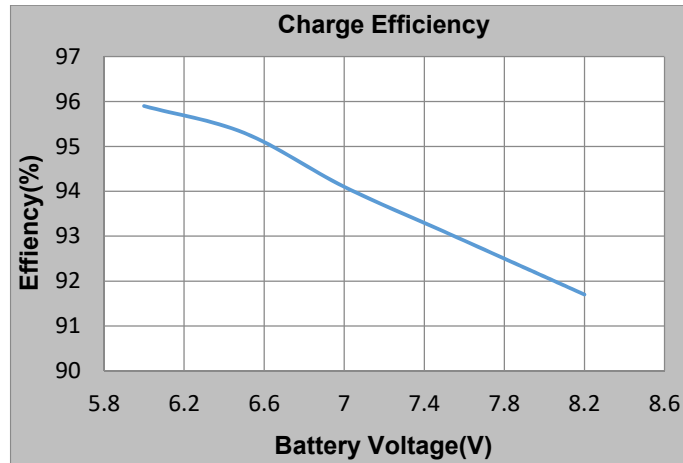
Buck Efficiency and Power Loss (Ta=25°C)

Vbat	Efficiency (%)				
	Io=1000mA	Io=1500mA	Io=2000mA	Io=2400mA	Io=3400mA
6.0V	95.6	94.7	93.9	92.9	91.1
7.0V	94.6	94.1	93.2	92.5	90.8
8.4V	91.7	92	91.7	91.2	90.1

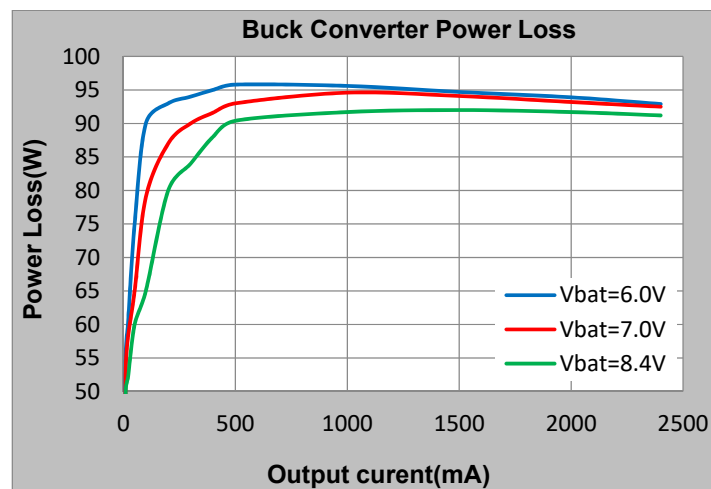

Vbat	Power Loss (W)				
	Io=1000mA	Io=1500mA	Io=2000mA	Io=2400mA	Io=3400mA
6.0V	0.23	0.42	0.65	0.91	1.67
7.0V	0.29	0.47	0.73	0.98	1.73
8.4V	0.46	0.65	0.91	1.16	1.88

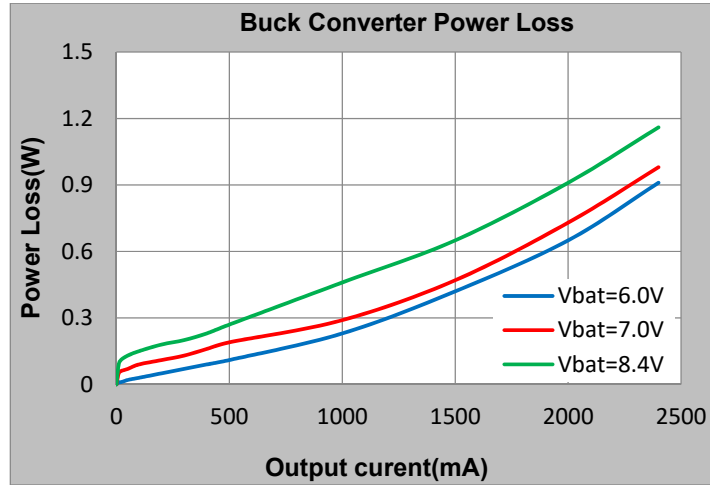

Buck Constant Current and Constant Voltage Regulation (Ta=25°C)

Buck V/I Profile (Output1)

	Vbat=6.0V		Vbat=7.0V		Vbat=8.0V	
	Vout(V)	Iout (mA)	Vout (V)	Iout (mA)	Vout(V)	Iout (mA)
CC Load	5.23	0	5.23	0	5.23	0
	5.24	12	5.08	12	5.08	12
	5.07	200	5.07	200	5.07	200
	5.06	500	5.06	500	5.06	500
	5.04	800	5.04	800	5.04	800
	5.04	1000	5.04	1000	5.04	1000
CV Load	5	1281	5	1281	5	1278
	4.9	1281	4.9	1280	4.9	1277
	4.8	1280	4.8	1280	4.8	1277
	4.6	1280	4.6	1280	4.6	1277
	4.4	1280	4.4	1280	4.4	1276
	4.2	1280	4.2	1280	4.2	1276
	4	1280	4	1280	4	1276
	3.9	1280	3.9	1280	3.9	1276
	3.8	1280	3.8	1280	3.8	1276
	3.7	1280	3.7	1280	3.7	1276
	3.6	1280	3.6	1280	3.6	1276
	3.5	0	3.5	0	3.5	0

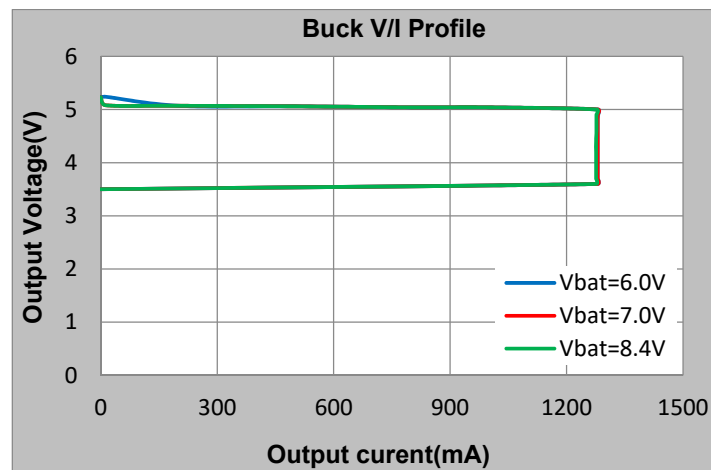

Buck V/I Profile (Output2)

	Vbat=6.0V		Vbat=7.0V		Vbat=8.0V	
	Vout(V)	Iout(mA)	Vout (V)	Iout(mA)	Vout(V)	Iout(mA)
CC Load	5.23	0	5.23	0	5.23	0
	5.08	12	5.08	10	5.08	10
	5.02	1000	5.02	1000	5.01	1000
	4.99	1500	4.99	1500	4.98	1500
	4.96	2000	4.97	2000	4.96	2000
	4.94	2400	4.95	2400	4.94	2240
CV Load	4.92	2682	4.92	2692	4.92	2630
	4.9	2681	4.9	2687	4.9	2675
	4.8	2677	4.8	2685	4.8	2680
	4.6	2676	4.6	2683	4.6	2678
	4.4	2675	4.4	2681	4.4	2677
	4.2	2674	4.2	2679	4.2	2676
	4	2673	4	2677	4	2675
	3.9	2672	3.9	2676	3.9	2674
	3.8	2672	3.8	2675	3.8	2672
	3.7	2671	3.7	2674	3.7	2671
	3.6	2671	3.6	2674	3.6	2670
	3.5	2671	3.5	2673	3.5	2668
	3.4	0	3.4	0	3.4	0

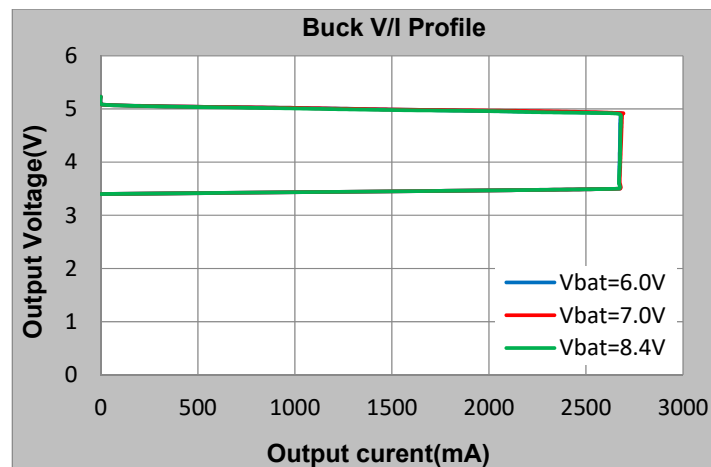

Battery Leakage Current in HZ Mode

Test Conditions	Battery Input Current (μA)	Power Loss (μW)
Vbat=6V	2.5	15
Vbat=7V	2.6	18.2
Vbat=8V	2.8	22.4
Vbat=8.4V	3.1	26

Ripple and Noise

Ripple & noise are measured by using 20MHz bandwidth limited oscilloscope.

Test Conditions	Output Ripple at 2.4A Load (mV)	Output Ripple at 3.4A Load (mV)
Vbat=6.0V	45	50
Vbat=7.0V	40	50
Vbat=8.4V	40	45

Load Dynamic Response Load Step

(Output2=80mA-1A-80mA load step Output1=0A)
 Vbat=8.0V Vbat=6.6V

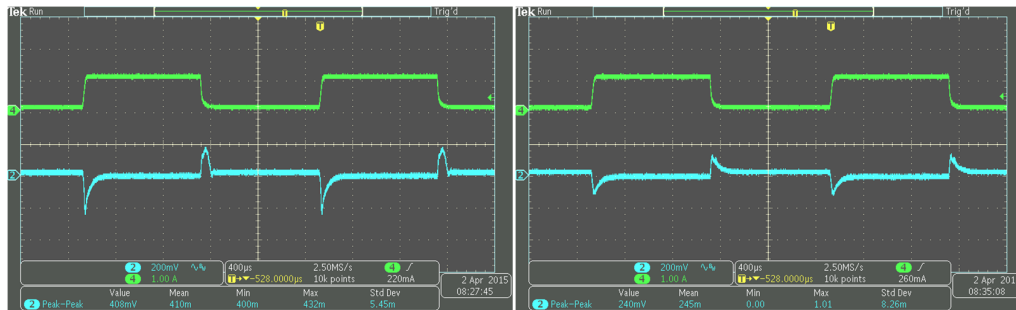

(Output2=1A-2.4A-1A load step Output1=0A)
 Vbat=8.0V Vbat=6.6V

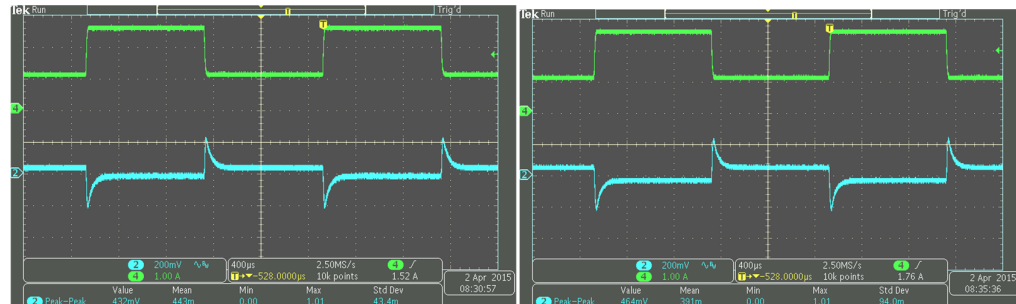

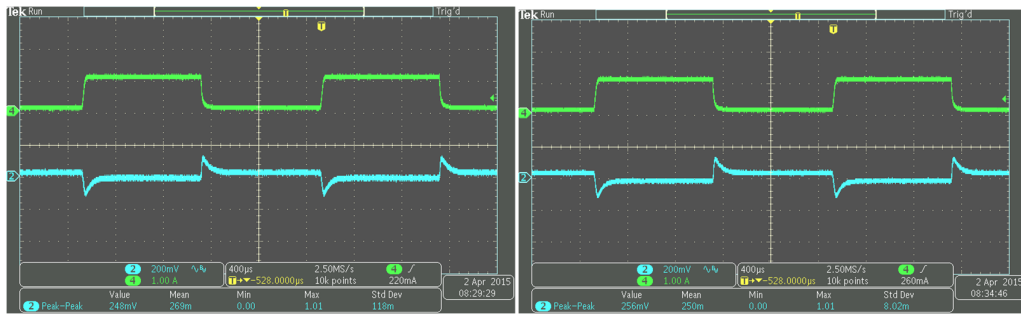
(Output2=80mA-1A-80mA load step Ouput1=1A)
 Vbat=8V Vbat=6.6V

(Output2=1A-2.4A-1A load step Ouput1=1A)

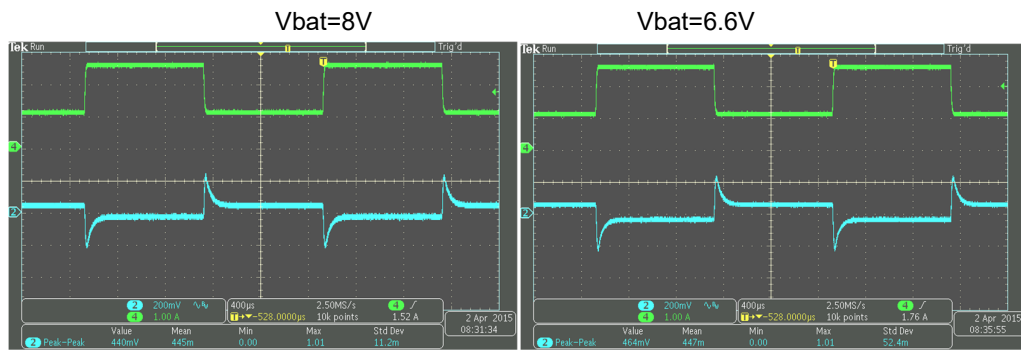

LED Indication

Conventional LED indication

PB time>40ms (HZ Mode)	LED1	LED2	LED3	LED4
$V_{BAT} < V_{cut-off}$	Off	Off	Off	Off
$V_{cut-off} \leq V_{BAT} < V_{LED1}$	Flash	Off	Off	Off
$V_{LED1} \leq V_{BAT} < V_{LED2}$	On	Off	Off	Off
$V_{LED2} \leq V_{BAT} < V_{LED3}$	On	On	Off	Off
$V_{LED3} \leq V_{BAT} < V_{LED4}$	On	On	On	Off
$V_{BAT} \geq V_{LED4}$	On	On	On	On

Charge Mode	LED1	LED2	LED3	LED4
$V_{BAT} < V_{LED1}$	Flash	Off	Off	Off
$V_{LED1} \leq V_{BAT} < V_{LED2}$	Flash	Off	Off	Off
$V_{LED2} \leq V_{BAT} < V_{LED3}$	On	Flash	Off	Off
$V_{LED3} \leq V_{BAT} \leq V_{LED4}$	On	On	Flash	Off
$V_{LED4} \leq V_{BAT} \leq EOC \text{ Mode}$	On	On	On	Flash
$LED4 \leq V_{BAT} (EOC \text{ Mode})$	On	On	On	On

ACT2804 is designed with a simple ADC to convert 5 levels of PT pin voltage into 5 application patterns.

INDICATION PATTERN	PT Resistor
Conventional Always On In Discharge	R15=3.3K
Conventional 5s Indication in Discharge	R15=12K
Breathing 5s Indication in Discharge	R15=24K
Bottom Charging 5s Indication in Discharge	R15=42K
Circulating 5s Indication in Discharge	R15=68K

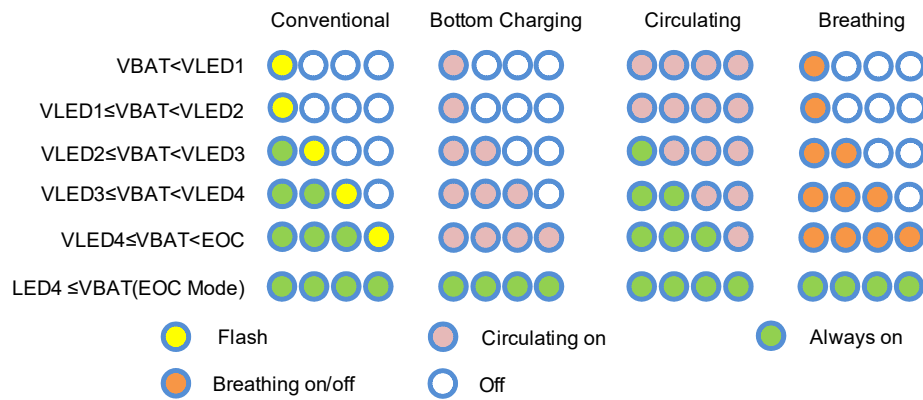

System Management

- PB is pressed for >5s or Discharge load is <10mA for 12.5s, Discharge mode is go into HZ mode
- PB is pressed for 40ms, Discharge mode is turned on
- PB is pressed for 40ms, LED indication is on for 5.0 seconds
- 2 seconds transition time between Charge Mode and Boost Mode

Key Components Temperature Test (Ta=25C, burning for 2 hours)

Charge mode, 1.0A charge current

Vin(V)	IC(°C)	Inductor(°C)	Vbat(V)
5	36.5	34.3	6
5	45.4	41.8	7.5
5	51.6	46.6	8.2

Discharge mode, 3.4A output current

Vbat(V)	IC(°C)	Inductor(°C)	Vout(V)
6	69.3	62	5
7.5	76.6	65.8	5
8.2	78.5	67.1	5

EMI Test

Vbat=7.8V, Output: 5.07V/3.4A Horizontal

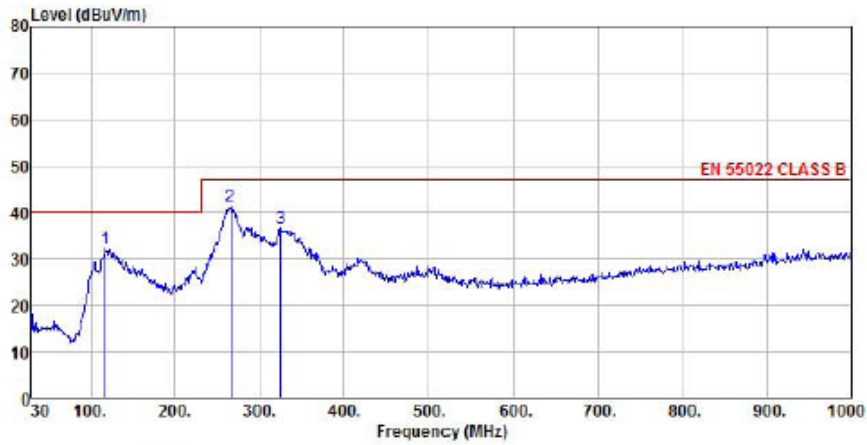

```

Site       : chamber
Condition  : EN 55022 CLASS B 3m VULB9160 HORIZONTAL
EUT       :
Model Name : case 22
Temp/Humi  : 22 °C / 51 %
Power Rating: 5V 3.4A
Mode       :
Memo       :
  
```

		ReadAntenna	Cable	Preamp		Limit	Over	
	Freq	Level	Factor	Loss	Factor	Level	Line	Limit
	MHz	dBuV	dB/m	dB	dB	dBuV/m	dBuV/m	dB
1	117.30	18.88	11.84	1.44	0.00	32.16	40.00	-7.84 Peak
2	pp 265.71	26.93	12.33	2.20	0.00	41.46	47.00	-5.54 Peak
3	324.88	20.20	13.78	2.50	0.00	36.48	47.00	-10.52 Peak

Vbat=7.8V, Output: 5.07V/3.4A Vertical

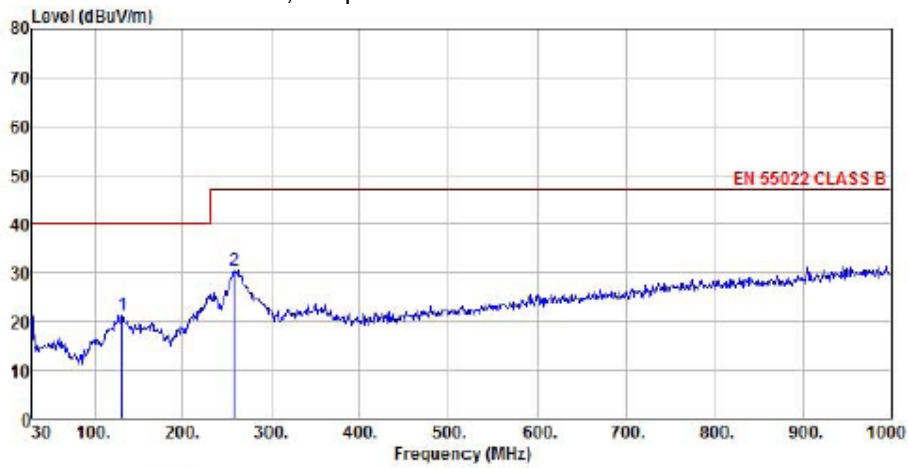

Site : chamber
 Condition : EN 55022 CLASS B 3m VULB9160 VERTICAL
 EUT :
 Model Name : case 14
 Temp/Humi : 22 °C / 51 %
 Power Rating: 5V 3.4A
 Mode :
 Memo :

	Freq	ReadAntenna Level	Antenna Factor	Cable Loss	Preamp Factor	Level	Limit Line	Over Limit	Remark
	MHz	dBuV	dB/m	dB	dB	dBuV/m	dBuV/m	dB	
1	131.85	6.87	12.78	1.61	0.00	21.26	40.00	-18.74	Peak
2 pp	258.92	16.26	12.09	2.18	0.00	30.53	47.00	-16.47	Peak

Schematic

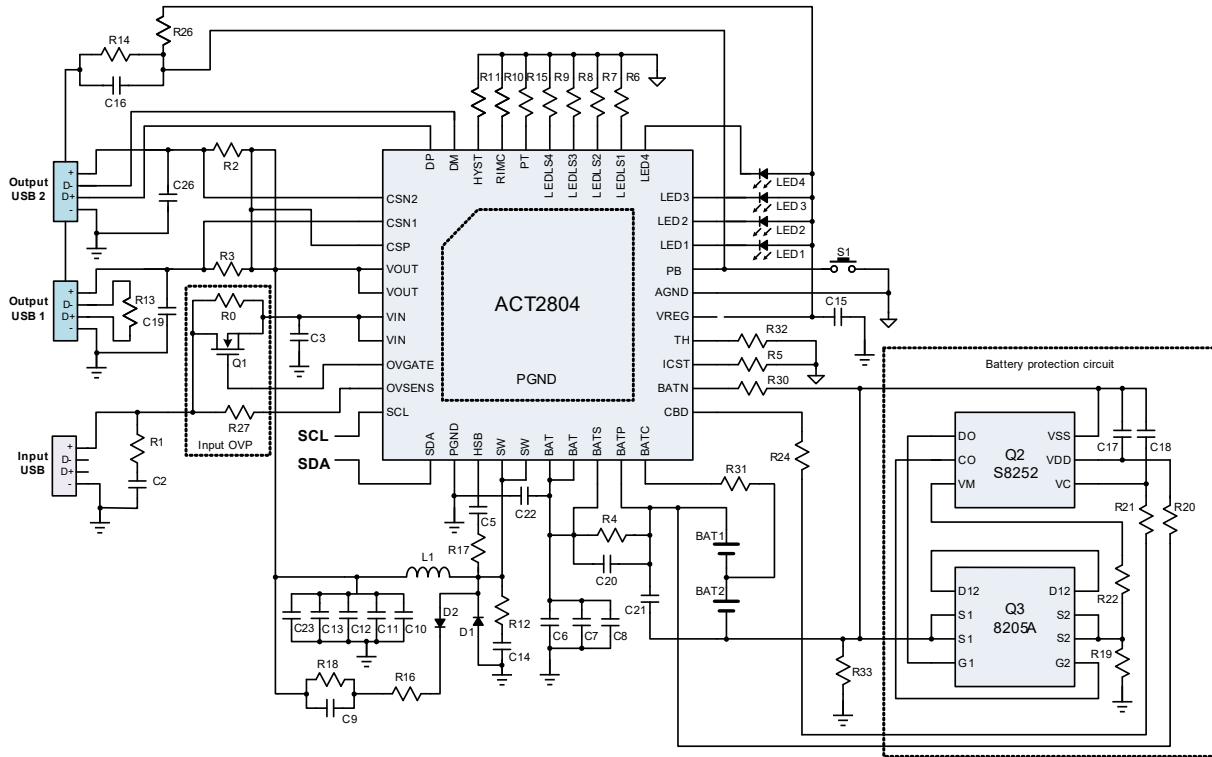

Bill of Materials

Item	Designator	Description	QTY		MFR
1	L1	SWPA8040S4R7NT, 4.7uH 5.9A	EA2804QJ-T	EA2804QJ-T0435	Sunlord
2	D1	MBR1020VL, 20V/1A Schottky	0	0	Panjit
3	D2	MBR1020VL, 20V/1A Schottky	0	0	Panjit
4	C2	Ceramic capacitor, 4.7uF/10V, 0805	1	1	Murata/TDK
5	C3, C10, C11, C12	Ceramic capacitor, 10uF/10V, 1206	4	4	Murata/TDK
6	C8, C21, C22	Ceramic capacitor, 22uF/16V, 1206	3	3	Murata/TDK
7	C5, C9	Ceramic capacitor, 47nF/16V, 0603	2	2	Murata/TDK
8	C6, C13	Ceramic capacitor, 0.1uF/16V, 0603	2	2	Murata/TDK
9	C14	Ceramic capacitor, 2.2nF/16V	1	1	Murata/TDK
10	C15	Ceramic capacitor, 1uF/10V	1	1	Murata/TDK
11	C16	Ceramic capacitor, 2.2uF/10V	1	1	Murata/TDK
12	C17, C18	Ceramic capacitor, 0.22uF/10V	0	0	Murata/TDK
13	C19, C26	Ceramic capacitor, 3.3uF/10V	2	2	Murata/TDK
14	C20	Ceramic capacitor, 100nF/10V	1	1	Murata/TDK
15	R1	Chip Resistor, 2.7Ω, 1/8W, 5%, 0805	1	1	Murata/TDK
16	R2, R3, R4	Chip Resistor, 25mΩ, 1/2W, 1%, 1206	3	3	Sart
17	R5	Chip Resistor, 8kΩ, 1/10W, 1%, 0603	1	1	Murata/TDK
18	R6	Chip Resistor, 83kΩ, 1/10W, 1%, 0603	1	1	Murata/TDK
19	R7	Chip Resistor, 63.5kΩ, 1/10W, 1%, 0603	1	1	Murata/TDK
20	R8	Chip Resistor, 51.4kΩ, 1/10W, 1%	1	1	Murata/TDK
21	R9	Chip Resistor, 41.5kΩ, 1/10W, 1%	1	1	Murata/TDK
22	R10, R11	Chip Resistor, 540kΩ, 1/10W, 1%	1	1	Murata/TDK
23	R12	Chip Resistor, 0.47Ω, 1/8W, 1%, 0805	1	1	Murata/TDK
24	R13	Chip Resistor, 200Ω, 1/10W, 1%, 0603	1	1	Murata/TDK
25	R14, R26	Chip Resistor, 715K, 1/10W, 5%, 0603	2	2	Murata/TDK
26	R15	Chip Resistor, 12K, 1/10W, 1%, 0603	1	1	Murata/TDK
27	R16	Chip Resistor, 4.7Ω, 1/8W, 1%, 0805	0	0	Murata/TDK
28	R17	Chip Resistor, 10Ω, 1/10W, 5%, 0603	1	1	Murata/TDK
29	R18	Chip Resistor, 47Ω, 1/8W, 5%, 0805	0	0	Murata/TDK
30	R20, R21	Chip Resistor, 510Ω, 1/10W, 5%, 0603	0	0	Murata/TDK
31	R22	Chip Resistor, 1K, 1/10W, 5%, 0603	0	0	Murata/TDK
32	R24	Chip Resistor, 47Ω, 1/4W, 1%, 1206	1	1	Murata/TDK
33	R27	Chip Resistor, 100Ω, 1/10W, 1%, 0603	1	1	Murata/TDK
34	R30, R31	Chip Resistor, 510Ω, 1/10W, 5%, 0603	2	2	Murata/TDK
35	R32	Chip Resistor, 10K, 1/10W, 5%, 0603	1	1	Murata/TDK

36	R33	Chip Resistor, 0Ω, 1/10W, 5%, 0603	1	1	Murata/TDK
37	LED1, LED2, LED3, LED4	LED, blue	4	4	LED Manu
38	Q1	20V/6.5A N MOSFET, SSF318	0	0	Silikron
39	Q2	2S Battery protection IC, S825	0	0	Seiko
40	Q3	20V Dual N-Channel Power MOSFET, 8205A	0	0	Fortune
41	PB	Push button	1	1	Shouhan
42	Output USB1, Output USB2	614104190121	2	2	Würth
43	Micro-USB	629105150921	1	1	Würth
44	U1	IC, ACT2804QJ-T, QFN55-40	1	0	Active Semi
		IC, ACT2804QJ-T0435, QFN55-40	0	1	

Компания «Океан Электроники» предлагает заключение долгосрочных отношений при поставках импортных электронных компонентов на взаимовыгодных условиях!

Наши преимущества:

- Поставка оригинальных импортных электронных компонентов напрямую с производств Америки, Европы и Азии, а так же с крупнейших складов мира;
- Широкая линейка поставок активных и пассивных импортных электронных компонентов (более 30 млн. наименований);
- Поставка сложных, дефицитных, либо снятых с производства позиций;
- Оперативные сроки поставки под заказ (от 5 рабочих дней);
- Экспресс доставка в любую точку России;
- Помощь Конструкторского Отдела и консультации квалифицированных инженеров;
- Техническая поддержка проекта, помощь в подборе аналогов, поставка прототипов;
- Поставка электронных компонентов под контролем ВП;
- Система менеджмента качества сертифицирована по Международному стандарту ISO 9001;
- При необходимости вся продукция военного и аэрокосмического назначения проходит испытания и сертификацию в лаборатории (по согласованию с заказчиком);
- Поставка специализированных компонентов военного и аэрокосмического уровня качества (Xilinx, Altera, Analog Devices, Intersil, Interpoint, Microsemi, Actel, Aeroflex, Peregrine, VPT, Syfer, Eurofarad, Texas Instruments, MS Kennedy, Miteq, Cobham, E2V, MA-COM, Hittite, Mini-Circuits, General Dynamics и др.);

Компания «Океан Электроники» является официальным дистрибьютором и эксклюзивным представителем в России одного из крупнейших производителей разъемов военного и аэрокосмического назначения «JONHON», а так же официальным дистрибьютором и эксклюзивным представителем в России производителя высокотехнологичных и надежных решений для передачи СВЧ сигналов «FORSTAR».



JONHON

«JONHON» (основан в 1970 г.)

Разъемы специального, военного и аэрокосмического назначения:

(Применяются в военной, авиационной, аэрокосмической, морской, железнодорожной, горно- и нефтедобывающей отраслях промышленности)

«FORSTAR» (основан в 1998 г.)

ВЧ соединители, коаксиальные кабели, кабельные сборки и микроволновые компоненты:

(Применяются в телекоммуникациях гражданского и специального назначения, в средствах связи, РЛС, а так же военной, авиационной и аэрокосмической отраслях промышленности).



Телефон: 8 (812) 309-75-97 (многоканальный)

Факс: 8 (812) 320-03-32

Электронная почта: ocean@oceanchips.ru

Web: <http://oceanchips.ru/>

Адрес: 198099, г. Санкт-Петербург, ул. Калинина, д. 2, корп. 4, лит. А