

Super low on resistance/Low voltage LDO

NO.EA-123-070828

OUTLINE

The R1173x Series are CMOS-based positive voltage regulator ICs. The R1173x Series have features of super low dropout, 1A output current capability, and -3mV typical load regulation at 1A. Even the output voltage is set at 1.5V, on resistance of internal FET is typically 0.32Ω . Therefore, applications that require a large current at small dropout are suitable for the R1173x series. Low input voltage is acceptable and low output voltage can be set. The minimum input voltage is 1.4V, and the lowest set output voltage is 0.8V. Each of these ICs consists of a voltage reference unit, an error amplifier, resistor net for setting output voltage, a current limit circuit at over-current, a chip enable circuit, a thermal-shutdown circuit, and so on. A stand-by mode with ultra low consumption current can be realized with the chip enable pin. The output voltage types of R1173 are fixed one in the IC and adjustable one (R1173x001x).

Since the packages for these ICs are the SOT-89-5 package, HSON-6, or HSOP-6J, high density mounting of the ICs on boards is possible.

FEATURES

- Output Current 1A
- Supply Current Typ. $60\mu\text{A}$
- Standby Current Typ. $0.1\mu\text{A}$
- Input Voltage Range 1.4V to 6.0V
- Output Voltage Range (R1173xxx1) 0.8V to 5.0V (HSOP-6J: 0.8V to 3.5V)
- Output Voltage Range (R1173x001) 1.0V to V_{IN}
- Dropout Voltage Typ. 0.32V ($V_{\text{OUT}}=1.5\text{V}$, $I_{\text{OUT}}=1\text{A}$)
Typ. 0.18V ($V_{\text{OUT}}=2.8\text{V}$, $I_{\text{OUT}}=1\text{A}$)
- Ripple Rejection Typ. 70dB ($V_{\text{OUT}}=2.8\text{V}$)
- Output Voltage Accuracy $\pm 2.0\%$
- Temperature-drift Coefficient of Output Voltage Typ. $\pm 100\text{ppm}/^\circ\text{C}$
- Line Regulation Typ. 0.05%/V
- Load Regulation Typ. -2mV ($I_{\text{OUT}}=300\text{mA}$)
Typ. -3mV ($I_{\text{OUT}}=1\text{A}$)
- Packages SOT-89-5, HSON-6, HSOP-6J
- Low inrush current at turning-on Typ. 500mA
- Built-in Current Limit Circuit Typ. 250mA
- Output capacitors $C_{\text{IN}}=\text{Ceramic } 4.7\mu\text{F}$
 $C_{\text{OUT}}=\text{Tantalum } 4.7\mu\text{F}$ ($V_{\text{OUT}} < 1.0\text{V}$)
 $C_{\text{OUT}}=\text{Ceramic } 4.7\mu\text{F}$ ($V_{\text{OUT}} \geq 1.0\text{V}$)
- Built-in Thermal Shutdown Circuit

APPLICATIONS

- Local Power source for Notebook PC.
- Local Power source for portable communication equipments, cameras, and videos.
- Local Power source for home appliances.

BLOCK DIAGRAMS

R1173xxx1B

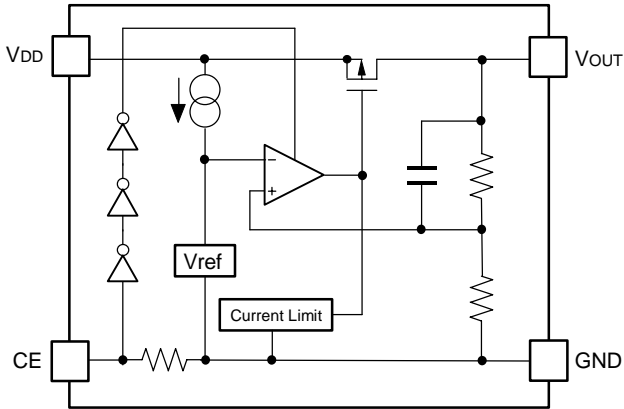

R1173xxx1D

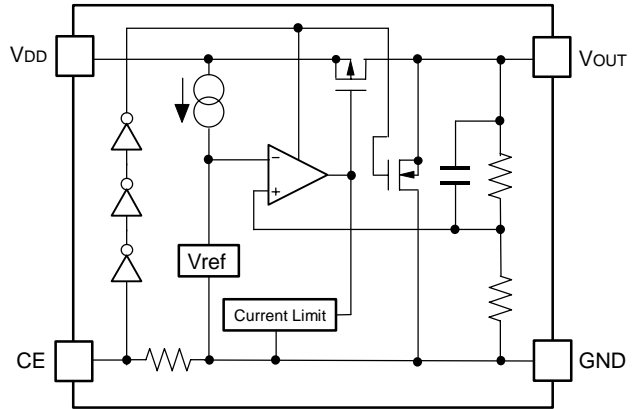

R1173x001B

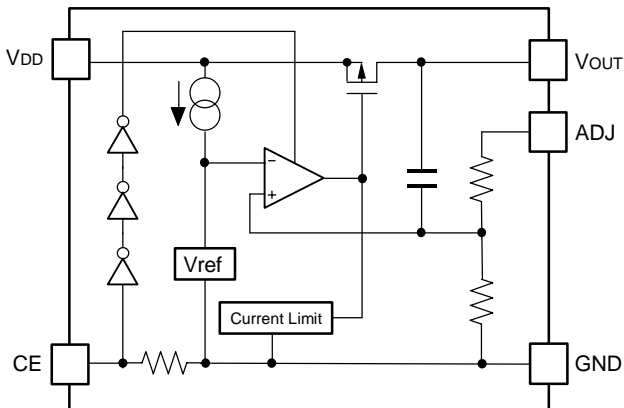

R1173x001D

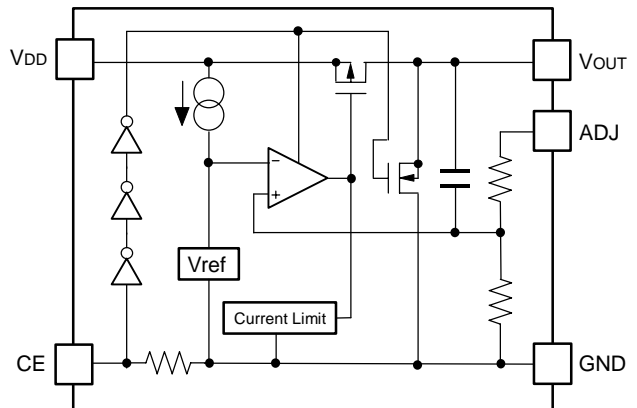

SELECTION GUIDE

The output voltage, auto discharge function*, the package type, etc. can be selected at the user's request.
The selection can be made with the part number as follows;

R1173xxx1x-xx-X ←Part Number
 ↑↑ ↑↑ ↑
 a b c d e

Code	Contents
A	Package Type; H: SOT-89-5, D: HSON-6, S: HSOP-6J
b	Designation of Output Voltage (V_{OUT}) External Setting Type: 00 (ADJ pin voltage is fixed at 1.0V.) Fixed Type: 08 to 50 (Stepwise setting with 0.1V increment in the range from 0.8V to 5.0V, exceptions; 1.85V output: R1173x181x5-xx, 2.85V output: R1173x281x5-xx)
c	Designation of Mask Option: B: Built-in Chip Enable Circuit, Active at "H", without auto discharge function* D: Built-in Chip Enable Circuit, Active at "H", with auto discharge function*
d	Designation of Taping Type; T1 (SOT-89-5), TR (HSON-6), E2 (HSOP-6J) (Refer to Taping Specifications)
e	Designation of composition of plating: -F: Lead free plating (SOT-89-5, HSON-6, HSOP-6J)

*) When the mode is into standby with CE signal, auto discharge transistor turns on, and it makes the turn-off speed faster than normal type.

PIN CONFIGURATIONS

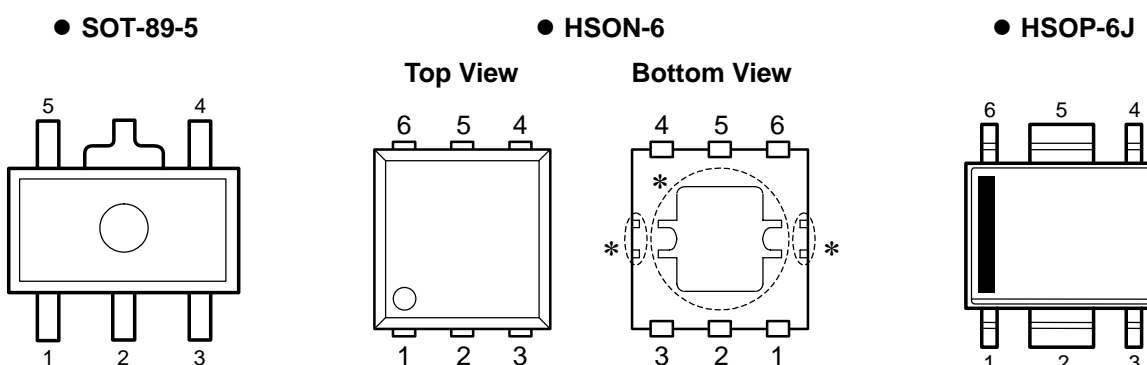

PIN DESCRIPTIONS

●SOT-89-5

Pin No.	Symbol	Description
1	ADJ or NC	ADJUST Pin (R1173H001x)
		No Connection (R1173Hxx1x)
2	GND	Ground Pin
3	CE	Chip Enable Pin
4	V _{DD}	Input Pin
5	V _{OUT}	Output Pin

●HSOP-6

Pin No.	Symbol	Description
1	V _{OUT}	Output Pin
2	V _{OUT}	Output Pin
3	ADJ or NC	ADJUST Pin (R1173D001x)
		No Connection (R1173Dxx1x)
4	GND	Ground Pin
5	CE	Chip Enable Pin
6	V _{DD}	Input Pin

* Tab in the  parts have GND level. (They are connected to the back side of this IC.)
Connect Pin1 and Pin2 as short as possible.

●HSOP-6J

Pin No.	Symbol	Description
1	V _{OUT}	Output Pin
2	GND	Ground Pin
3	ADJ or NC	ADJUST Pin (R1173S001x)
		No Connection (R1173Sxx1x)
4	CE	Chip Enable Pin
5	GND	Ground Pin
6	V _{DD}	Input Pin

ABSOLUTE MAXIMUM RATINGS

Symbol	Item	Rating	Unit
V _{IN}	Input Voltage	6.5	V
V _{CE}	Input Voltage (CE Input Pin)	-0.3 to 6.5	V
V _{OUT}	Output Voltage	-0.3 to V _{IN} +0.3	V
I _{OUT}	Output Current	1.4	A
P _D	Power Dissipation (SOT-89-5)* ¹	900	mW
	Power Dissipation (HSOP-6)* ¹	900	
	Power Dissipation (HSOP-6J)* ¹	1700	
T _{opt}	Operating Temperature	-40 to 85	°C
T _{stg}	Storage Temperature	-55 to 125	°C

*1) For Power Dissipation, please refer to PACKAGE INFORMATION to be described.

ELECTRICAL CHARACTERISTICS

• R1173xxxxB/D (Fixed Output Voltage Type)

T_{opt}=25°C

Symbol	Item	Conditions	Min.	Typ.	Max.	Unit
V _{IN}	Input Voltage		1.4		6.0	V
I _{SS}	Supply Current	V _{IN} -V _{OUT} =1.0V, V _{CE} =V _{IN} , I _{OUT} =0A		60	100	μA
I _{standby}	Standby Current	V _{IN} = 6.0V, V _{CE} =0V		0.1	1.0	μA
V _{OUT}	Output voltage	V _{IN} -V _{OUT} =1.0V I _{OUT} =100mA	V _{OUT} >1.5V	×0.98	×1.02	V
			V _{OUT} ≤ 1.5V	-30	+30	mV
I _{OUT}	Output Current	V _{IN} -V _{OUT} =1.0V	1			A
ΔV _{OUT} / ΔI _{OUT}	Load regulation	V _{IN} -V _{OUT} =0.3V, 1mA ≤ I _{OUT} ≤ 300mA If V _{OUT} ≤ 1.1V, then V _{IN} =1.4V	-15	-2	15	mV
		V _{IN} -V _{OUT} =0.3V, 1mA ≤ I _{OUT} ≤ 1A If V _{OUT} ≤ 1.1V, then V _{IN} =1.7V		-3		
V _{DIF}	Dropout Voltage	Refer to the following table				
ΔV _{OUT} / ΔV _{IN}	Line regulation	I _{OUT} =100mA, V _{OUT} +0.5V ≤ V _{IN} ≤ 6.0V If V _{OUT} ≤ 0.9V, 1.4V ≤ V _{IN} ≤ 6.0V		0.05	0.20	%/V
RR	Ripple Rejection	f=1kHz (V _{OUT} ≤ 4.0V) f=1kHz (V _{OUT} >4.0V) Ripple 0.5Vp-p, V _{IN} -V _{OUT} =1.0V, I _{OUT} =100mA If V _{OUT} ≤ 1.2V, V _{IN} -V _{OUT} =1.5V, I _{OUT} =100mA		70 60		dB
ΔV _{OUT} / ΔT _{opt}	Output Voltage Temperature Coefficient	I _{OUT} =100mA, -40°C ≤ T _{opt} ≤ 85°C		±100		ppm/ °C
I _{lim}	Short Current Limit	V _{OUT} =0V		250		mA
R _{PD}	Pull-down resistance for CE pin		1.9	5.0	15.0	MΩ
V _{CEH}	CE Input Voltage "H"		1.0		6.0	V
V _{CEL}	CE Input Voltage "L"		0		0.4	V
T _{TSD}	Thermal Shutdown Detector Threshold Temperature	Junction Temperature		150		°C
T _{TSR}	Thermal Shutdown Released Temperature	Junction Temperature		120		°C
en	Output Noise	BW=10Hz to 100kHz		30		μVrms

• Dropout Voltage by Output Voltage

T_{opt}=25°C

Output Voltage V _{OUT} (V)	Dropout Voltage V _{DIF} (V)		
	I _{OUT} =300mA		I _{OUT} =1A
	Typ.	Max.	Typ.
0.8 ≤ V _{OUT} < 0.9	0.33	0.57	0.72
0.9 ≤ V _{OUT} < 1.0	0.22	0.47	0.64
1.0 ≤ V _{OUT} < 1.5	0.18	0.32	0.56
1.5 ≤ V _{OUT} < 2.6	0.10	0.15	0.32
2.6 ≤ V _{OUT}	0.05	0.10	0.18

R1173x

- R1173x001B/D (Adjustable Output Voltage Type)

T_{opt}=25°C

Symbol	Item	Conditions	Min.	Typ.	Max.	Unit	
V _{IN}	Input Voltage		1.4		6.0	V	
I _{SS}	Supply Current	V _{OUT} =V _{ADJ} , V _{IN} =2.0, V _{CE} =V _{IN}		60	100	μA	
I _{standby}	Standby Current	V _{IN} =6.0V, V _{CE} =0V		0.1	1.0	μA	
V _{OUT}	Reference Voltage for Adjustable Voltage Regulator	V _{OUT} =V _{ADJ} , V _{IN} =2.0V I _{OUT} =100mA	0.970	1.000	1.030	V	
RV _{OUT}	Output Voltage Range		1.0		V _{IN}	V	
I _{OUT}	Output Current	V _{OUT} =V _{ADJ} , V _{IN} =2.0	1			A	
ΔV _{OUT} / ΔI _{OUT}	Load regulation	V _{IN} =1.4V 1mA ≤ I _{OUT} ≤ 300mA	-15	-2	15	mV	
		V _{IN} =1.7V 1mA ≤ I _{OUT} ≤ 1A		-3			
V _{DIF}	Dropout Voltage	V _{OUT} =V _{ADJ}	I _{OUT} =300mA		0.18	0.32	V
			I _{OUT} =1A		0.56		
ΔV _{OUT} / ΔV _{IN}	Line regulation	V _{OUT} =V _{ADJ} , I _{OUT} =100mA 1.5V ≤ V _{IN} ≤ 6.0V			0.05	0.20	%/V
RR	Ripple Rejection	f=1kHz Ripple 0.5Vp-p, V _{OUT} =V _{ADJ} , V _{IN} =2.5V I _{OUT} =100mA			70		dB
ΔV _{OUT} / ΔT _{opt}	Output Voltage Temperature Coefficient	I _{OUT} =100mA -40°C ≤ T _{opt} ≤ 85°C			±100		ppm/°C
I _{lim}	Short Current Limit	V _{OUT} =V _{ADJ} =0V			250		mA
R _{PD}	Pull-down resistance for CE pin		1.9	5.0	15.0		MΩ
V _{CEH}	CE Input Voltage "H"		1.0		6.0		V
V _{CEL}	CE Input Voltage "L"		0		0.4		V
T _{TSD}	Thermal Shutdown Detector Threshold Temperature	Junction Temperature			150		°C
T _{TSR}	Thermal Shutdown Released Temperature	Junction Temperature			120		°C
en	Output Noise	BW=10Hz to 100kHz			30		μVrms

Technical Notes on External Components and Typical Application

(Refer to the example of typical application)

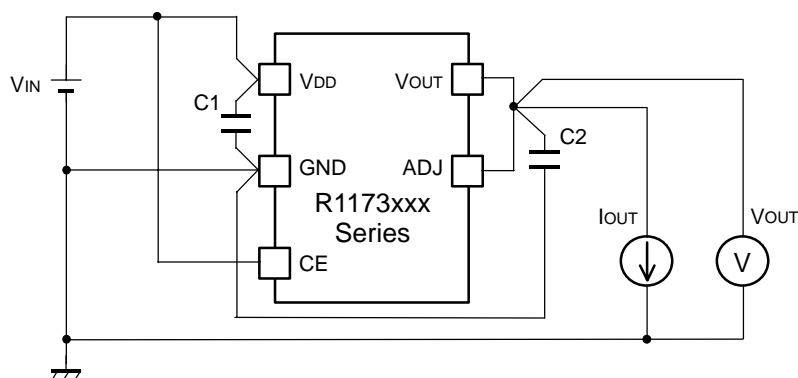

Example of the typical application of R1173x (Fixed Output Type)

Phase Compensation

In these ICs, phase compensation is made with the output capacitor for securing stable operation even if the load current is varied. For this purpose, use as much as a capacitor as C2. Recommendation value is as follows:

Mounting on PCB

Make V_{DD} and GND lines sufficient. If their impedance is high, a current flows, the noise picked up or unstable operation may result. Further use a $4.7\mu\text{F}$ or more value capacitor between V_{DD} pin and GND pin as close as possible.

Set an Output capacitor between V_{OUT} pin and GND pin for phase compensation as close as possible.

Output Voltage	C2 recommendation value	Components Recommendation	
$V_{OUT} < 1.0\text{V}$	Tantalum $4.7\mu\text{F}$ or more		
$1.0 \leq V_{OUT} < 3.3\text{V}$	Ceramic $4.7\mu\text{F}$ or more	Kyocera $4.7\mu\text{F}$ (1608) Murata $4.7\mu\text{F}$ (1608) Murata $10\mu\text{F}$ (1608)	Part Number: CM105X5R475M06AB Part Number: GRM188R60J475KE19B Part Number: GRM188B30G106ME46B
$3.3\text{V} \leq V_{OUT}$	Ceramic $4.7\mu\text{F}$ or more	Kyocera $4.7\mu\text{F}$ (thin 2012) Murata $10\mu\text{F}$ (1608)	Part Number: CT21X5R475M06AB Part Number: GRM188B30G106ME46B

If you use a tantalum type capacitor and ESR value of the capacitor is large, output might be unstable. Evaluate your circuit with considering frequency characteristics.

Depending on the capacitor size, manufacturer, and part number, the bias characteristics and temperature characteristics are different. Evaluate the circuit with actual using capacitors.

Technical Notes on Output Voltage Setting of Adjustable Output type (R1173x001x)

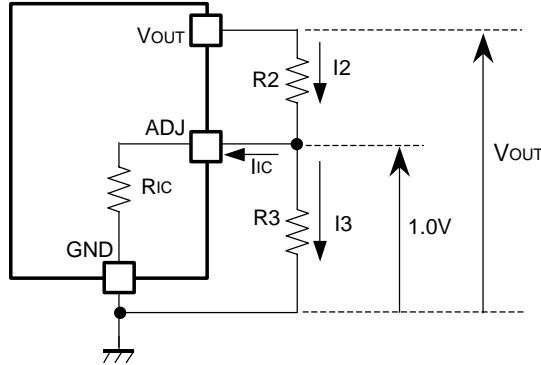

The Output Voltage may be adjustable for any output voltage between its 1.0V reference and its V_{DD} setting level. An external pair of resistors is required, as shown above.

The complete equation for the output voltage is described step by step as follows;

$$I_2 = I_{IC} + I_3 \dots\dots\dots (1)$$

$$I_3 = 1.0/R_3 \dots\dots\dots (2)$$

Thus,

$$I_2 = I_{IC} + 1.0/R_3 \dots\dots\dots (3)$$

Therefore,

$$V_{OUT} = 1.0 + R_2 \times I_2 \dots\dots\dots (4)$$

Put Equation (3) into Equation (4), then

$$\begin{aligned} V_{OUT} &= 1.0 + R_2(I_{IC} + 1.0/R_3) \\ &= 1.0(1 + R_2/R_3) + R_2 \times I_{IC} \dots\dots\dots (5) \end{aligned}$$

In 2nd term, or $R_2 \times I_{IC}$ will produce an error in V_{OUT} .

In Equation (5),

$$I_{IC} = 1.0/R_{IC} \dots\dots\dots (6)$$

$$\begin{aligned} R_2 \times I_{IC} &= R_2 \times 1.0/R_{IC} \\ &= 1.0 \times R_2/R_{IC} \dots\dots\dots (7) \end{aligned}$$

For better accuracy, choosing $R_2 \ll R_{IC}$ reduces this error.

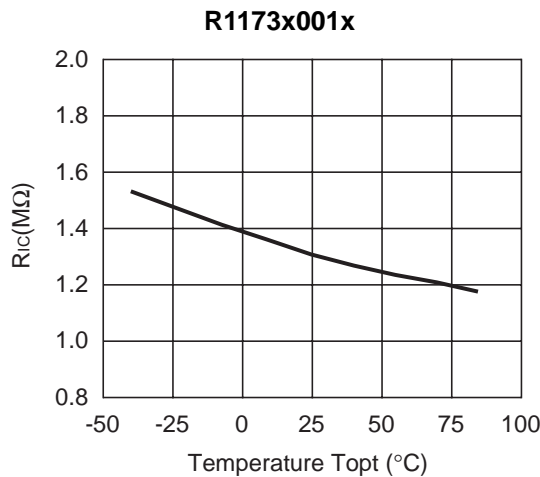

*) The graph is a typical characteristic, please evaluate the circuit with an actual condition.

TYPICAL CHARACTERISTICS

1) Output Voltage vs. Output Current (Topt=25°C)

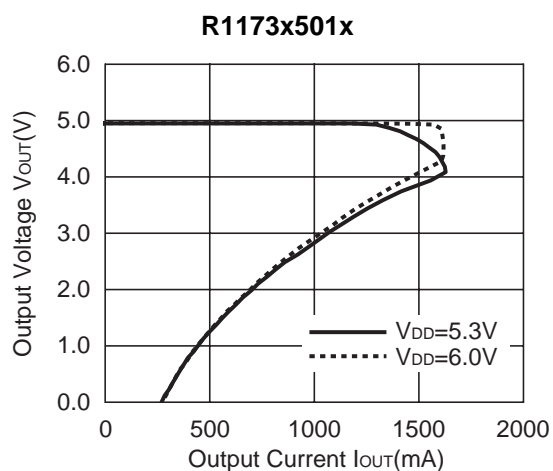
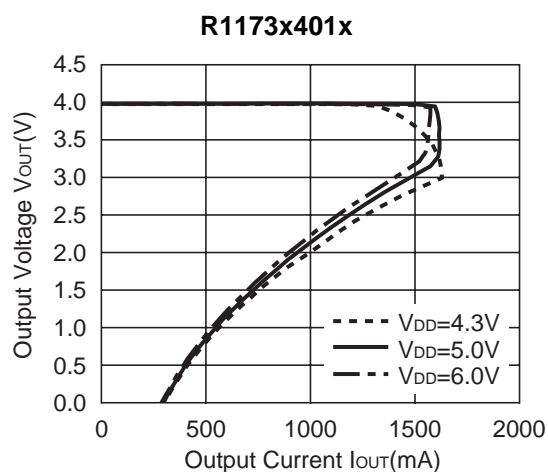
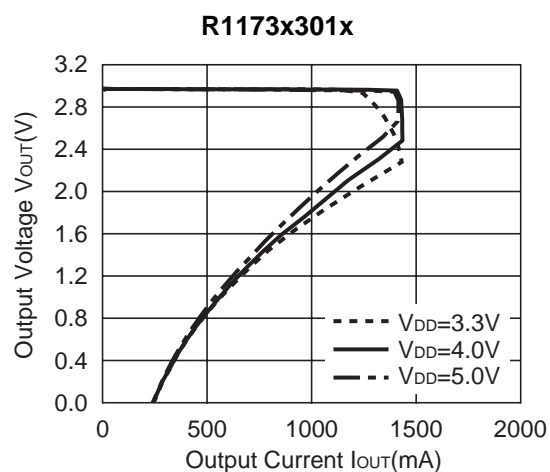
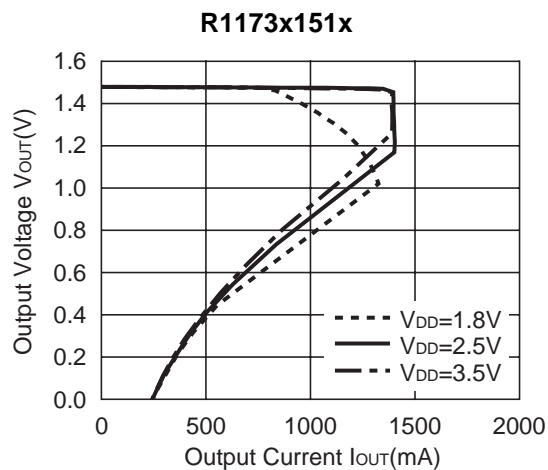
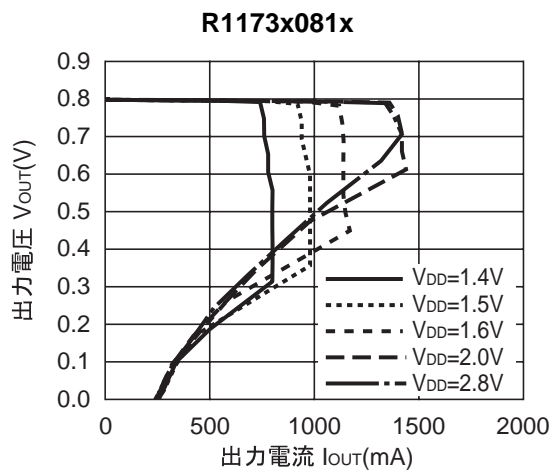

2) Output Voltage vs. Input Voltage (T_{opt}=25°C)

R1173x081x

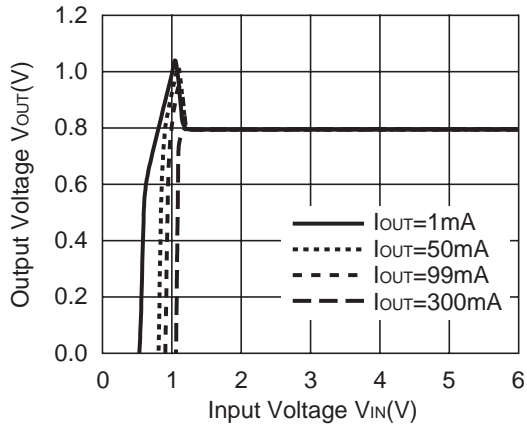

R1173x151x

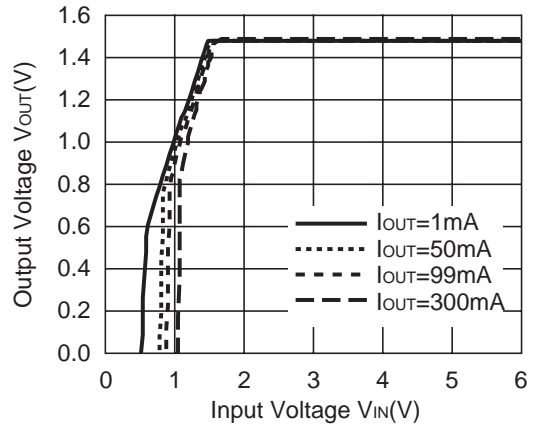

R1173x301x

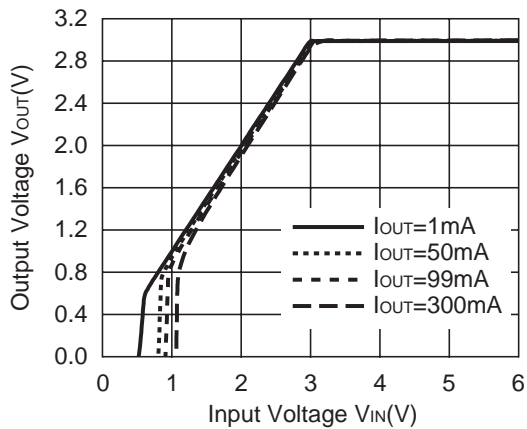

R1173x401x

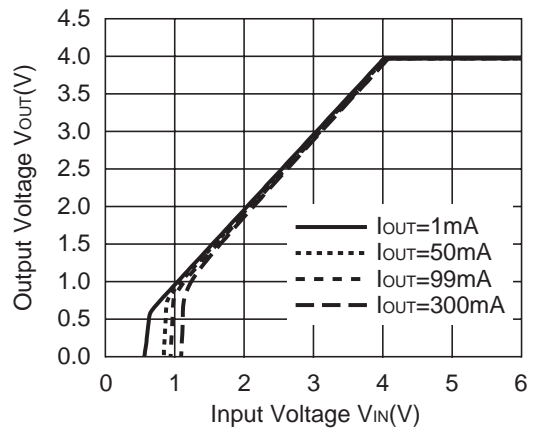

R1173x501x

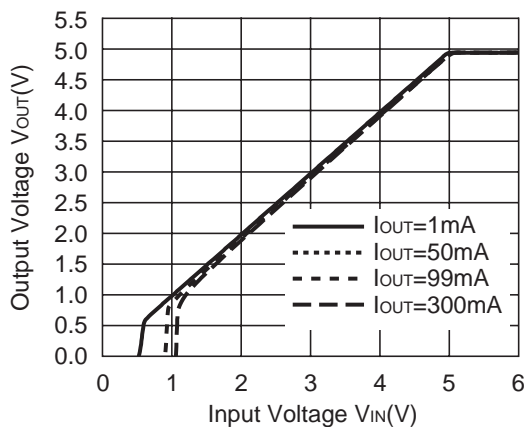

3) Dropout Voltage vs. Output Current ($T_{opt}=25^{\circ}\text{C}$)

R1173x081x

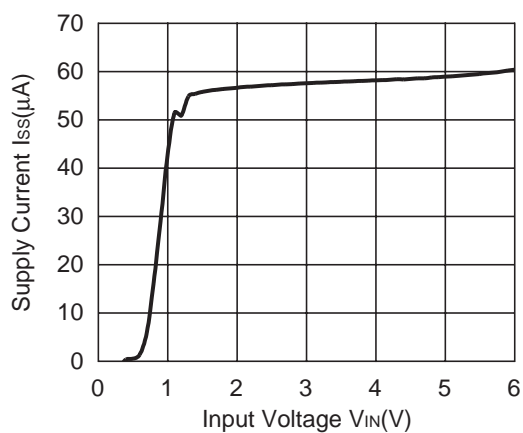

R1173x151x

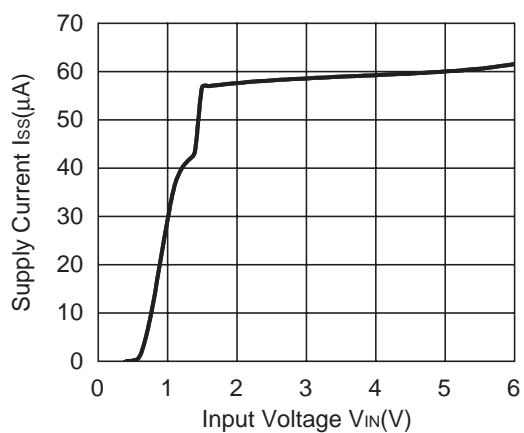

R1173x301x

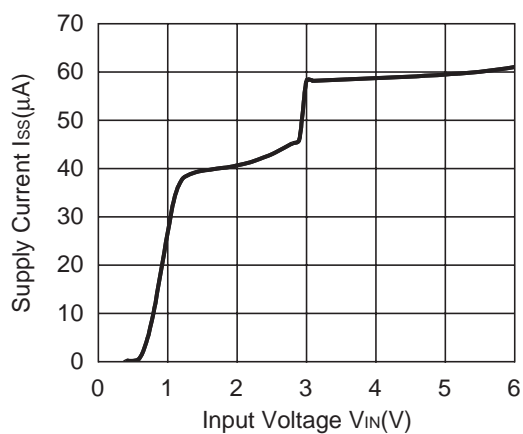

R1173x401x

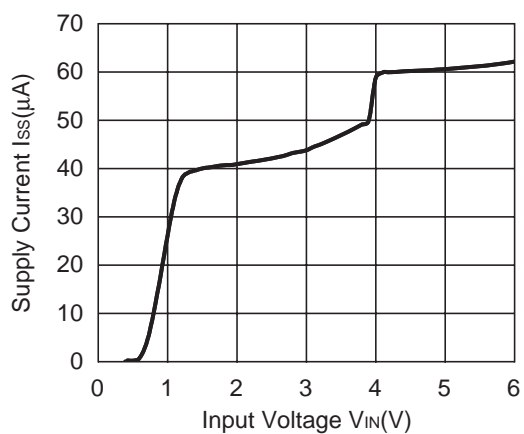

R1173x501x

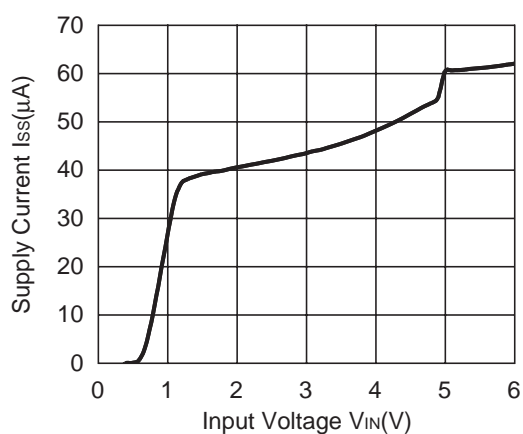

4) Output Voltage vs. Temperature ($I_{OUT}=100mA$)

R1173x081x

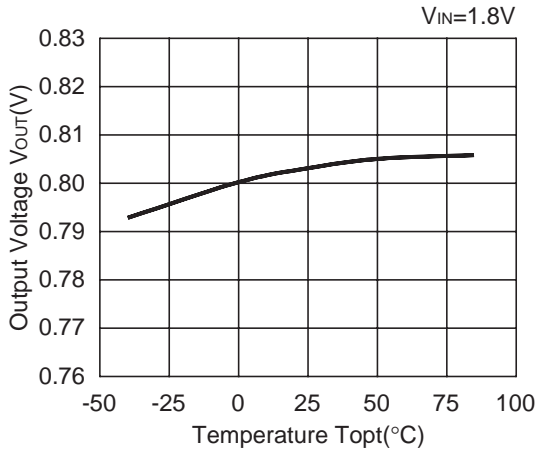

R1173x151x

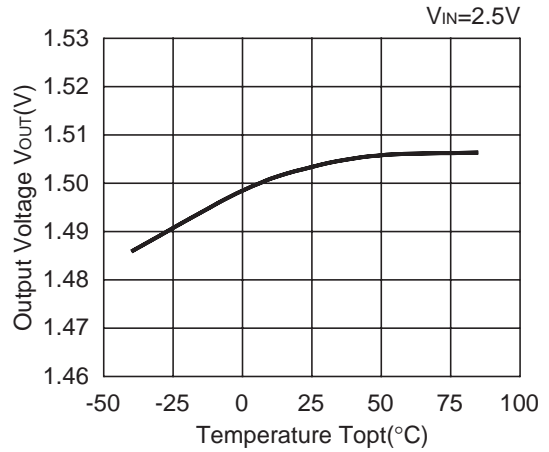

R1173x301x

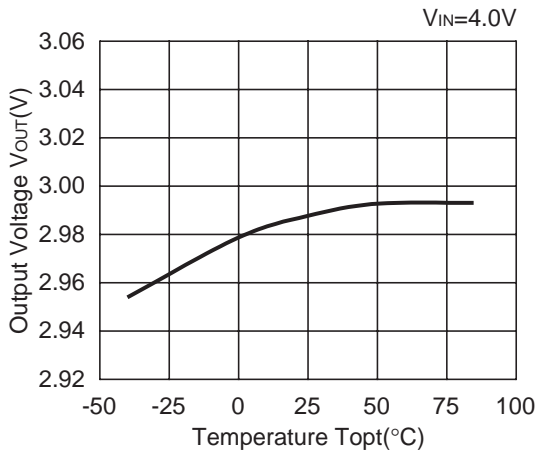

R1173x501x

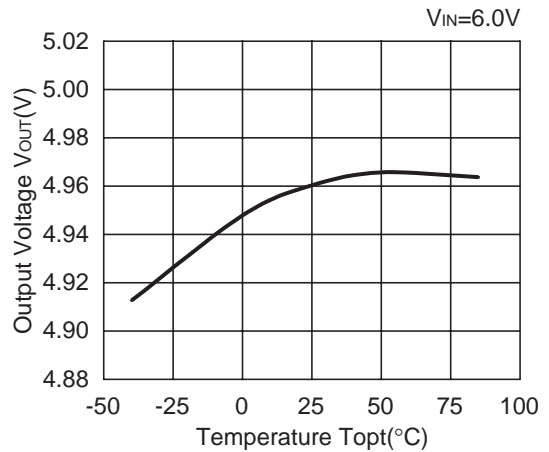

5) Supply Current vs. Temperature

R1173x081x

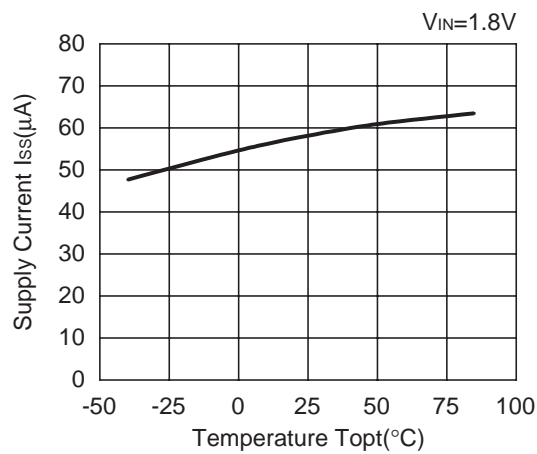

R1173x151x

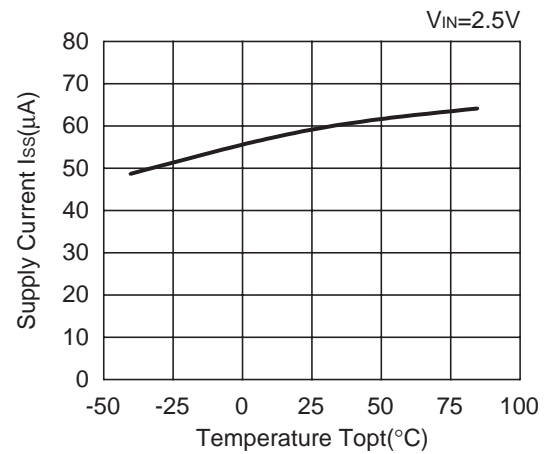

R1173x301x

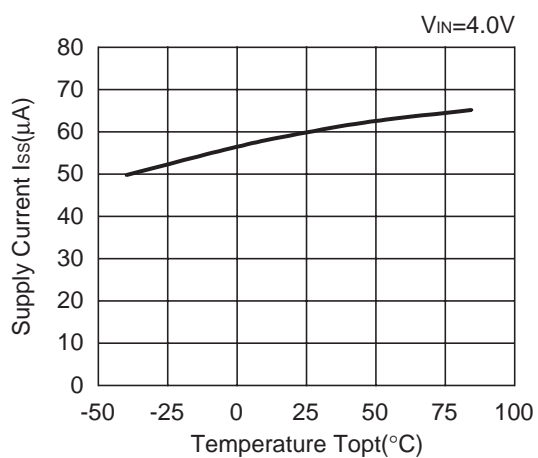

R1173x501x

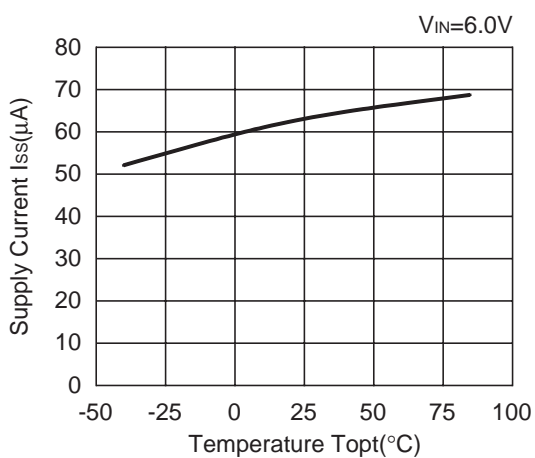

6) Dropout Voltage vs. Output Current

R1173x081x

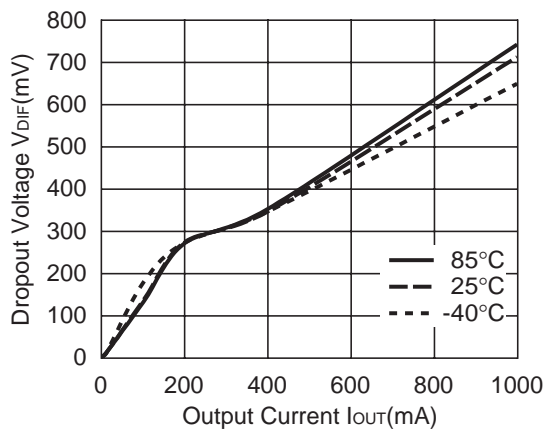

R1173x091x

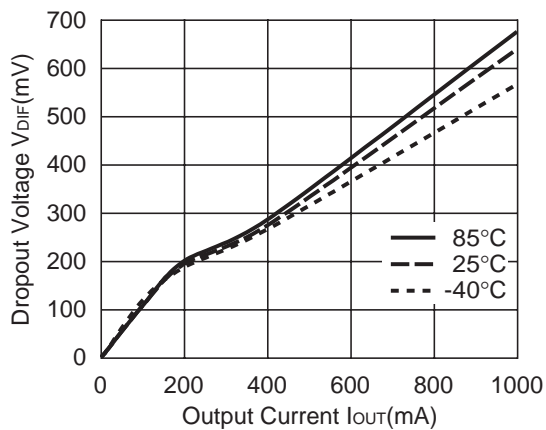

R1173x101x

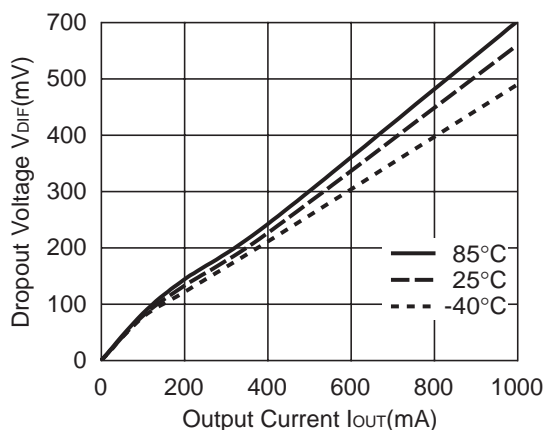

R1173x151x

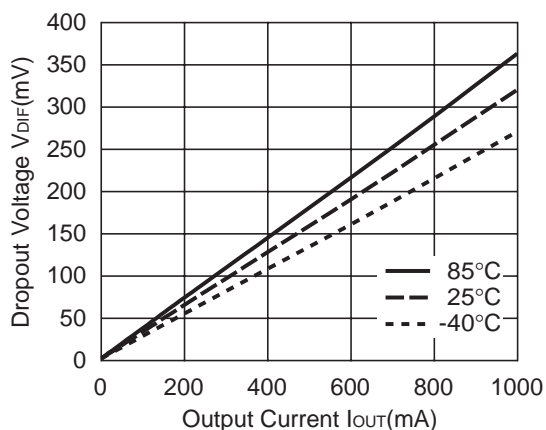

R1173x

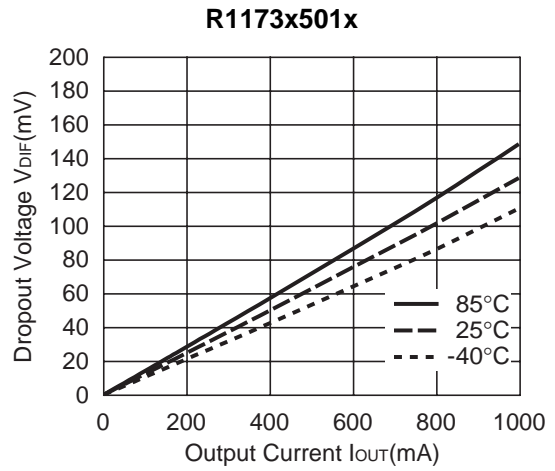
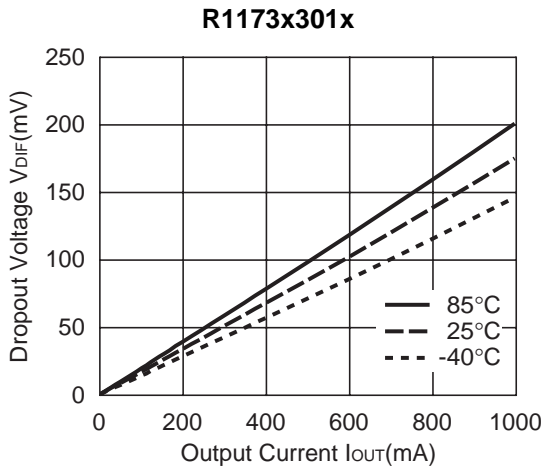

7) Dropout Voltage vs. Set Output Voltage

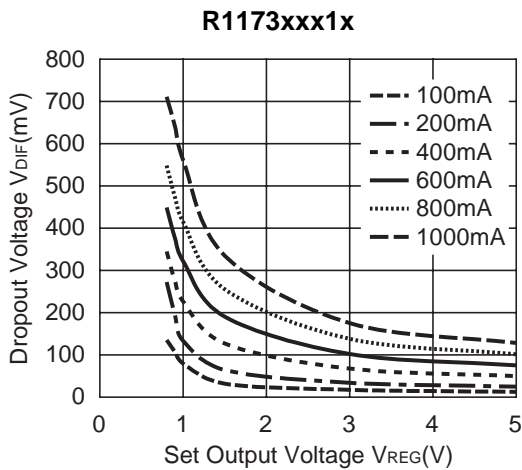

8) 0.8V Output type, Operating Input Voltage Range

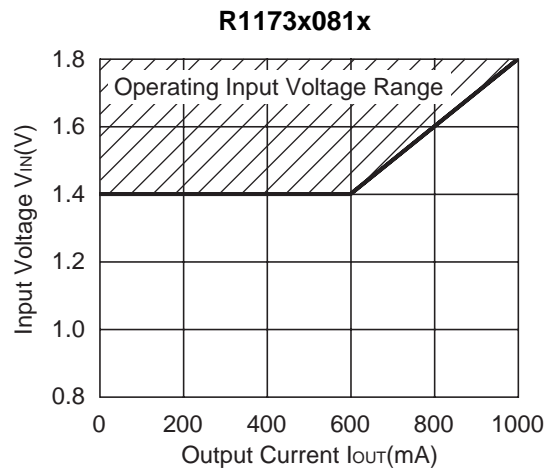

9) Ripple Rejection vs. Input Bias

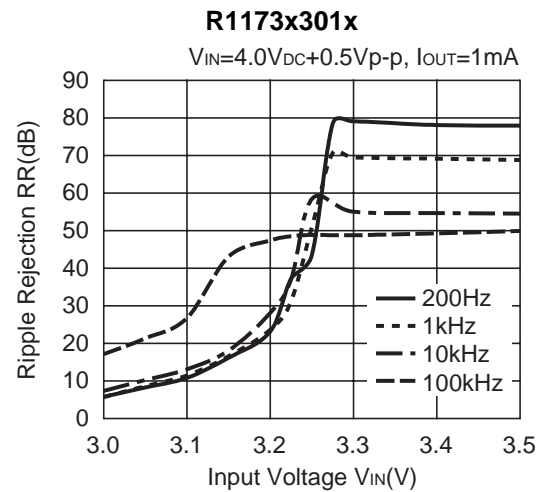
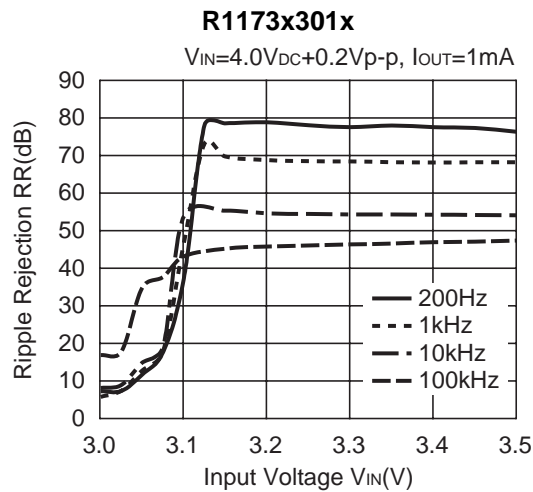

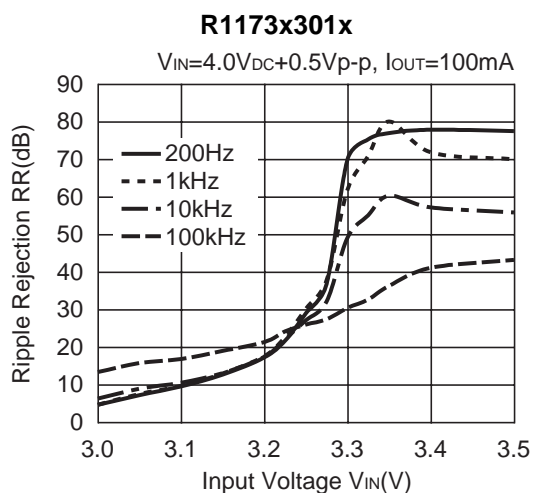
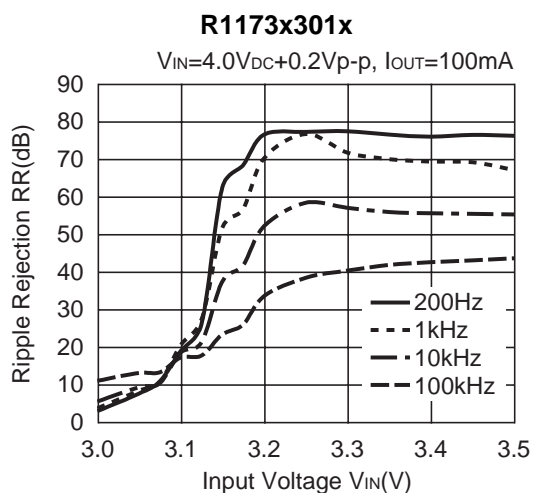
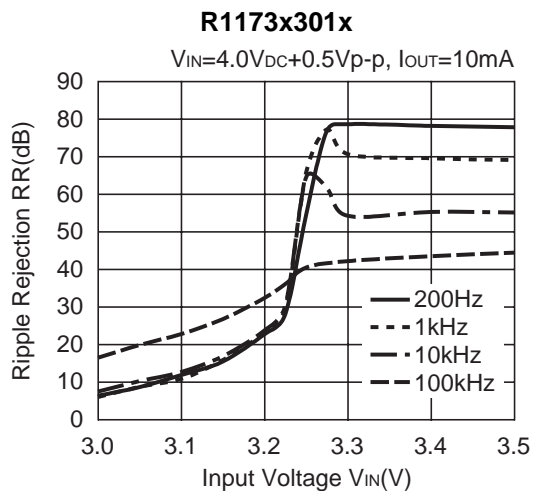
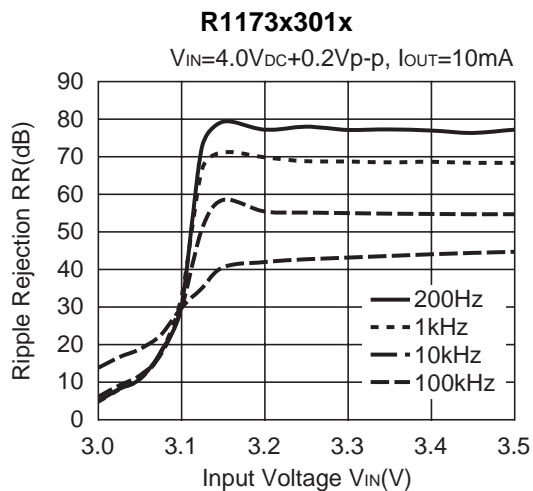

10) Ripple Rejection vs. Frequency

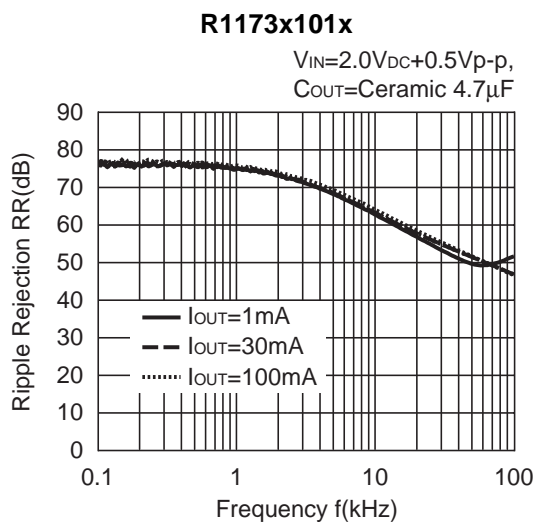
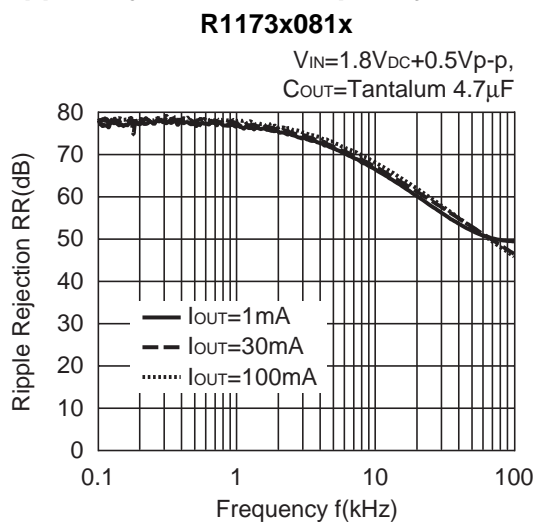

R1173x301x

$V_{IN}=4.0V_{DC}+0.5V_{p-p}$,
 $C_{OUT}=\text{Ceramic } 4.7\mu F$

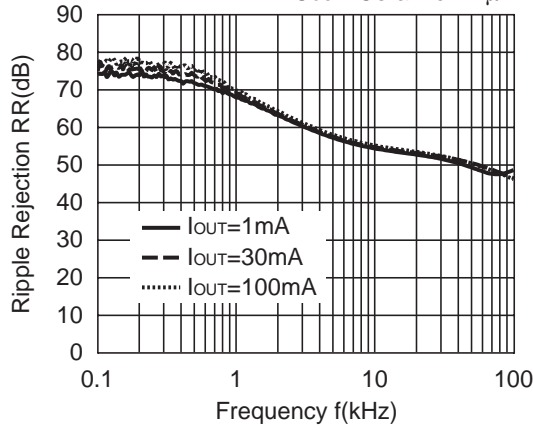

R1173x401x

$V_{IN}=5.0V_{DC}+0.5V_{p-p}$,
 $C_{OUT}=\text{Ceramic } 4.7\mu F$

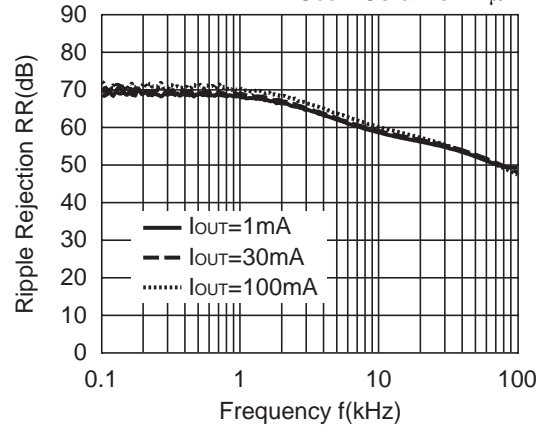

R1173x451x

$V_{IN}=5.5V_{DC}+0.5V_{p-p}$,
 $C_{OUT}=\text{Ceramic } 4.7\mu F$

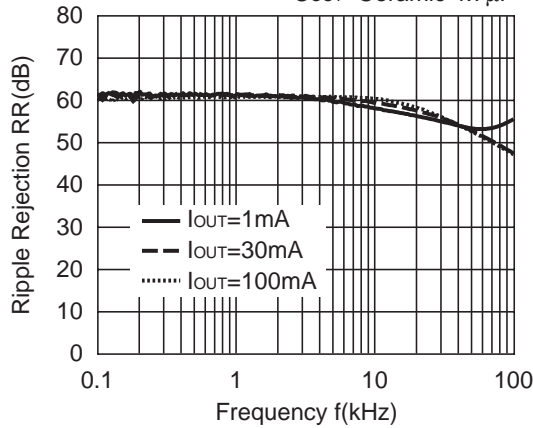

R1173x501x

$V_{IN}=6.0V_{DC}+0.5V_{p-p}$,
 $C_{OUT}=\text{Ceramic } 4.7\mu F$

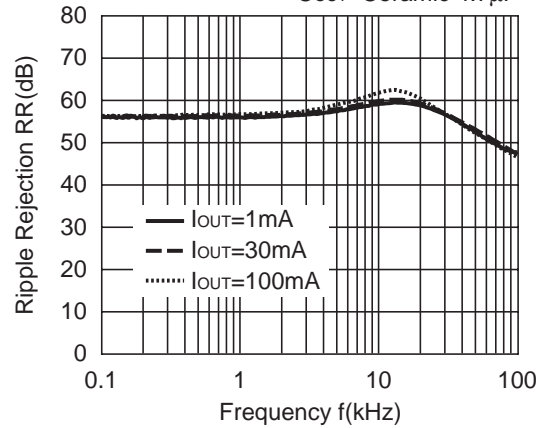

11) Line Transient Response ($T_r=T_f=5\mu s$, $I_{OUT}=100mA$)

R1173x081x

$C_{OUT}=\text{Tantalum } 4.7\mu F$

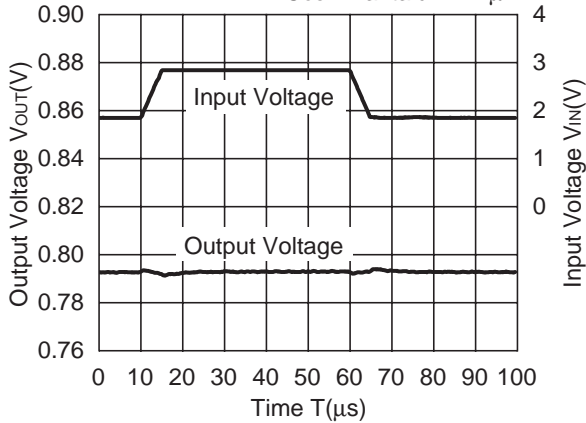

R1173x101x

$C_{OUT}=\text{Ceramic } 4.7\mu F$

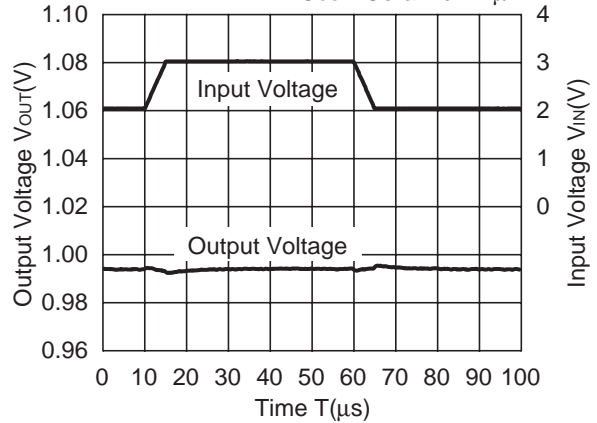

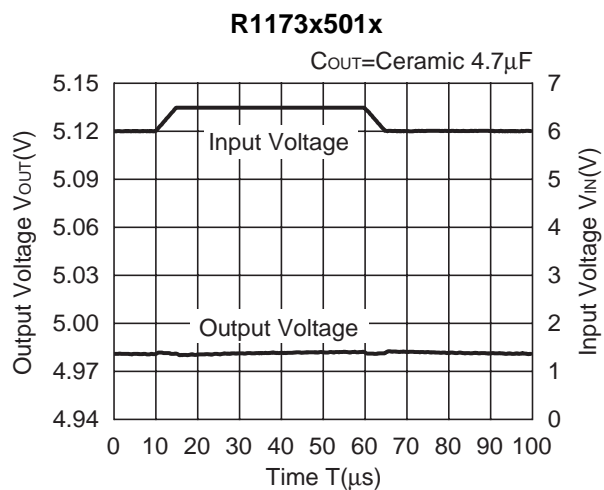
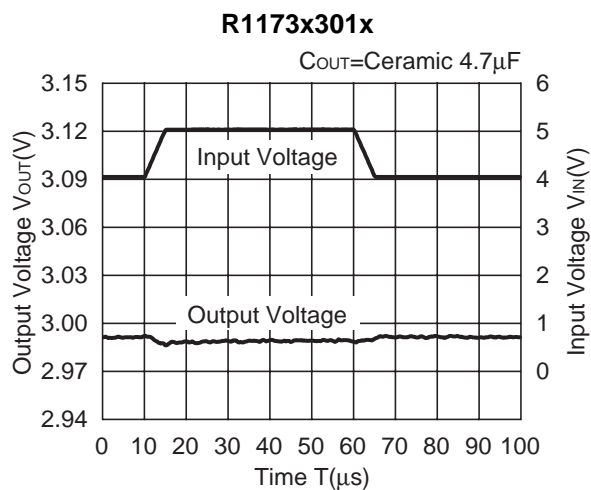

12) Load Transient Response ($T_r = T_f = 500\text{ns}$)

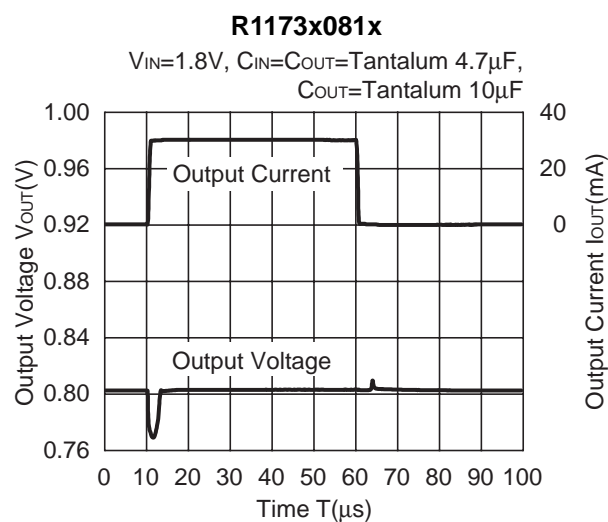
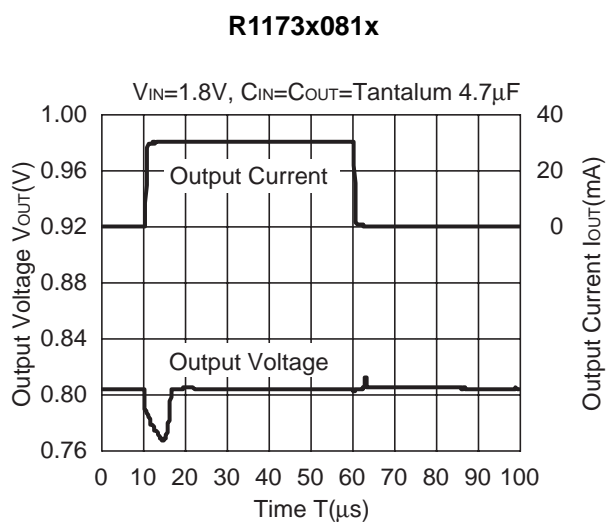
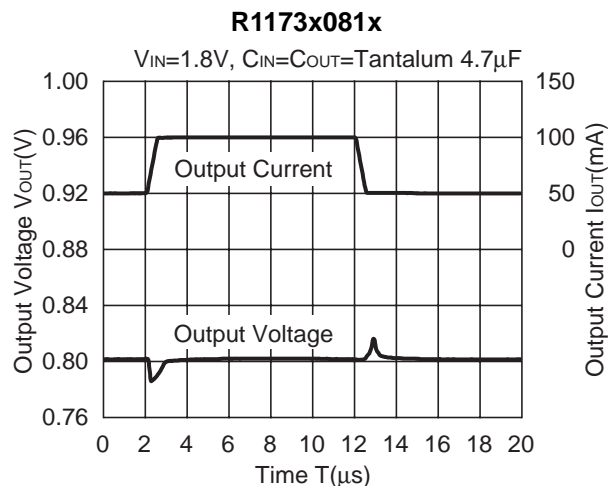
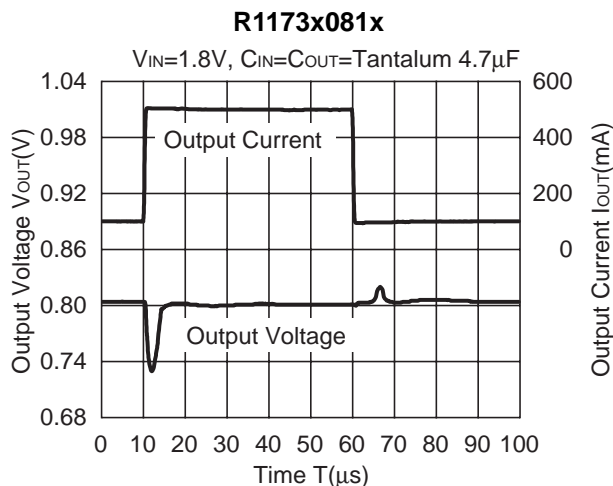

R1173x101x

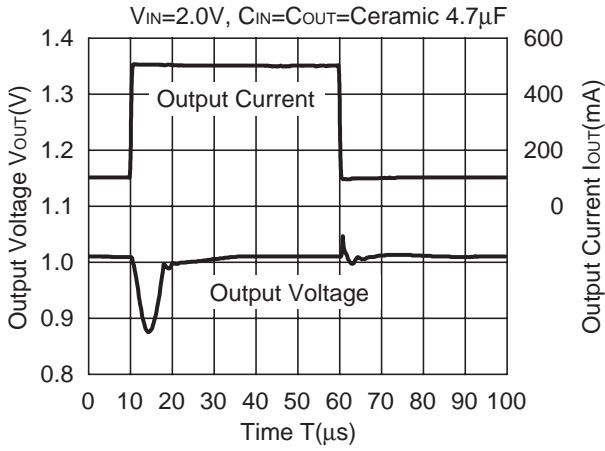

R1173x101x

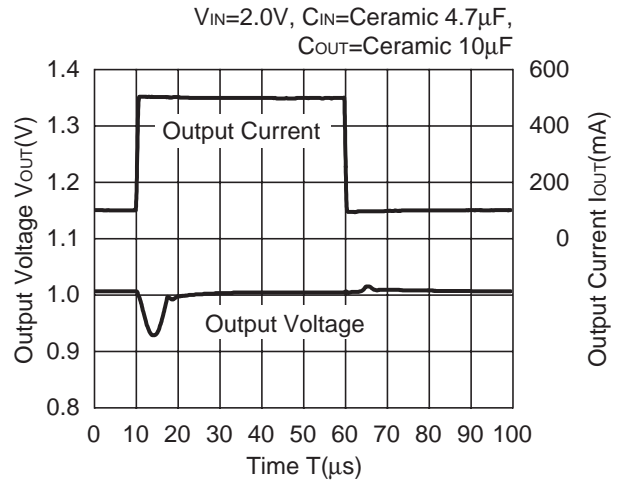

R1173x101x

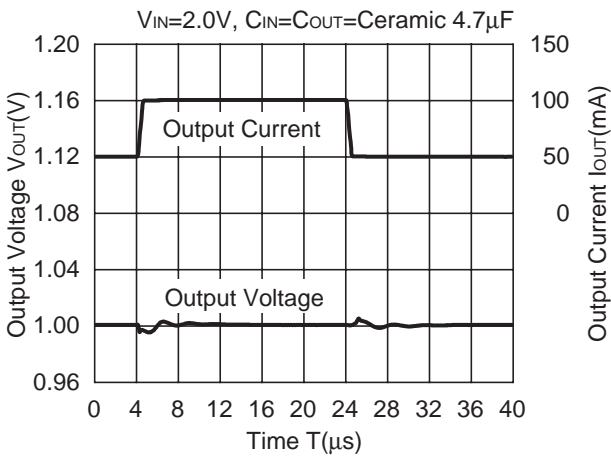

R1173x101x

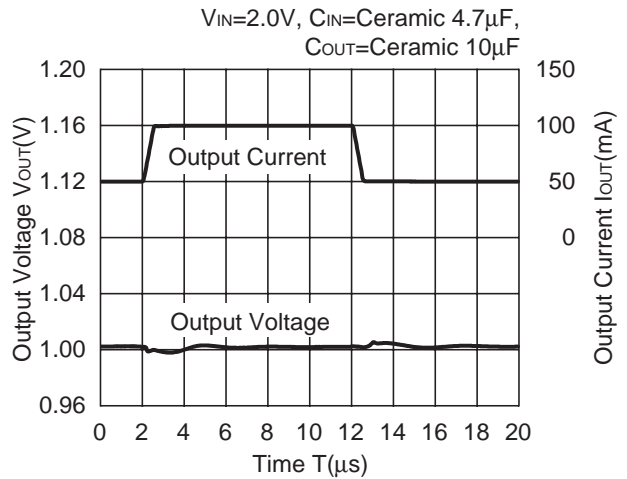

R1173x101x

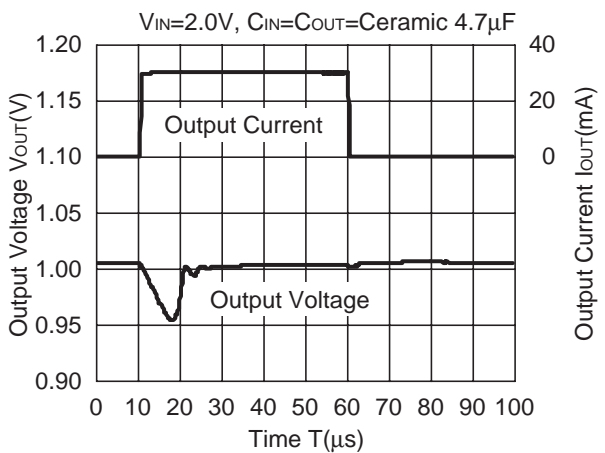

R1173x101x

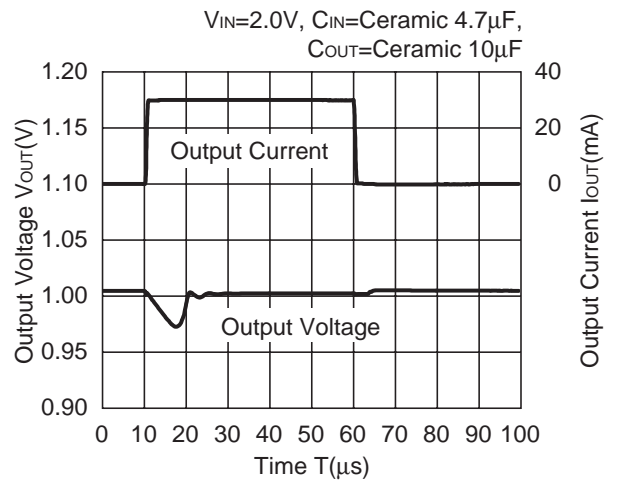

R1173x301x

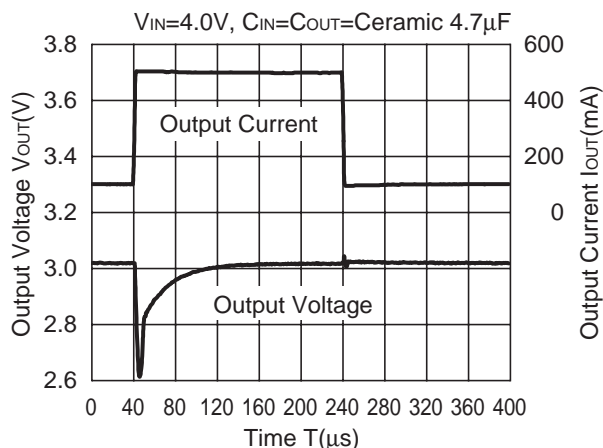

R1173x301x

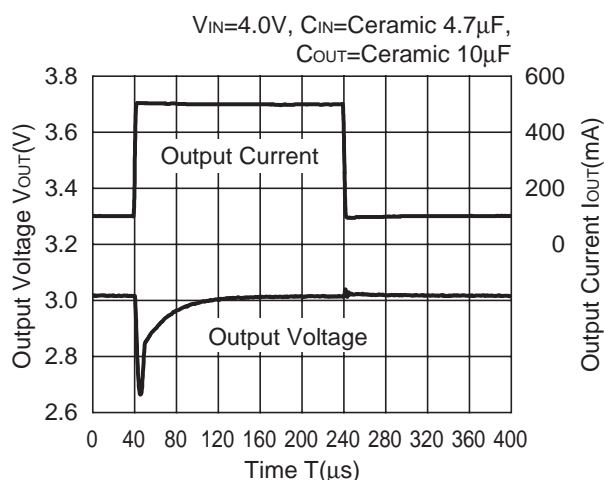

R1173x301x

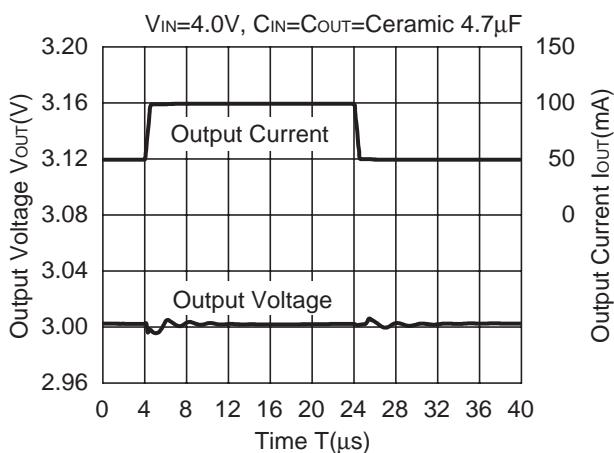

R1173x301x

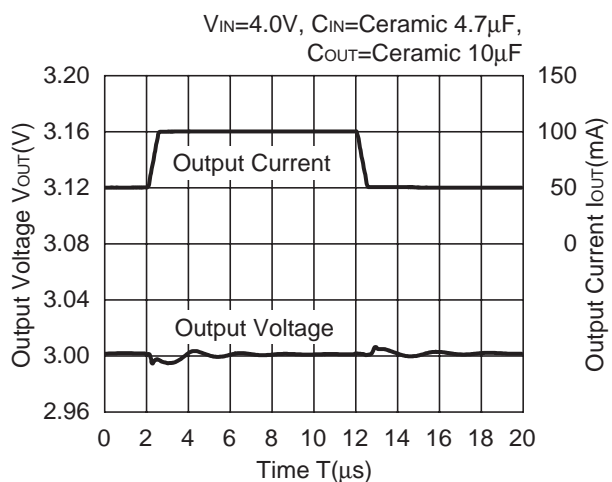

R1173x301x

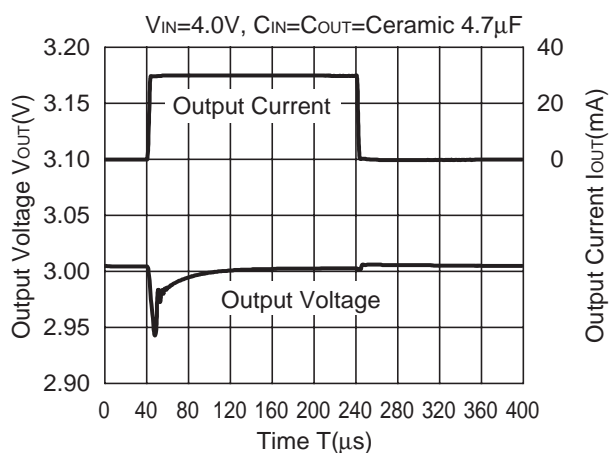

R1173x301x

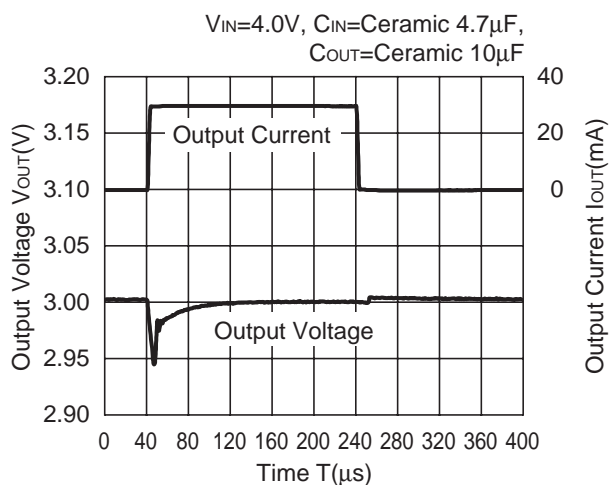

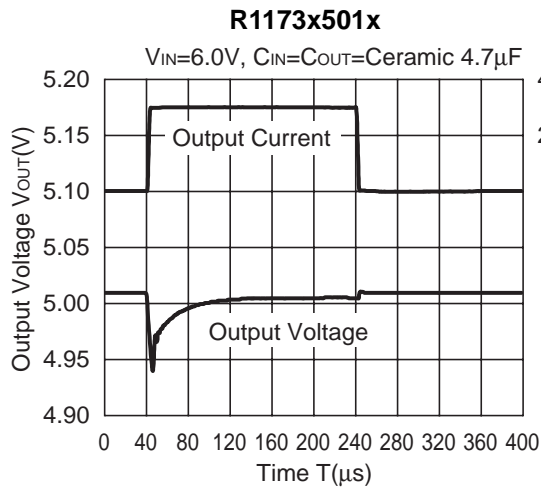
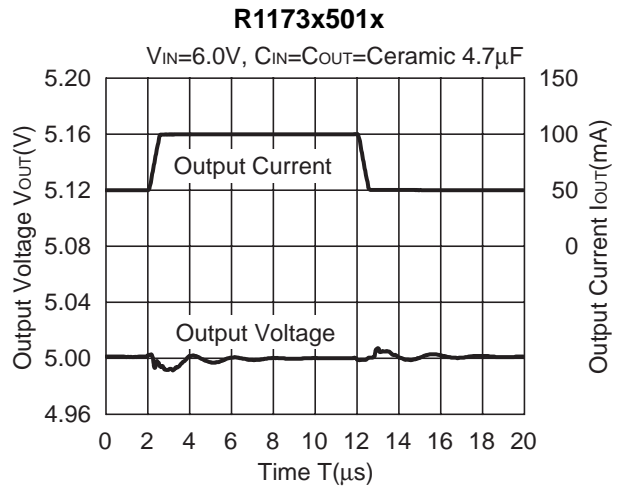
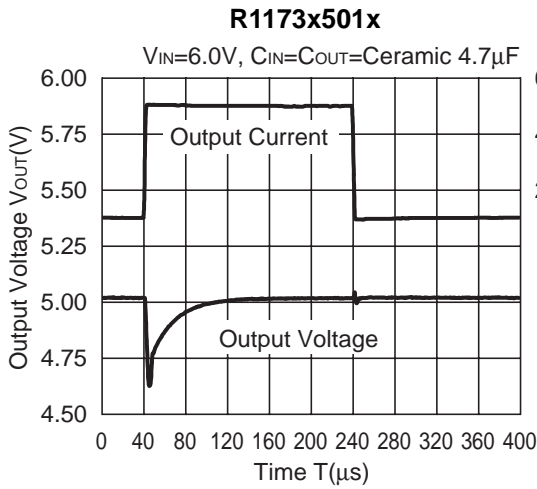

13) Turn-on speed with CE pin control

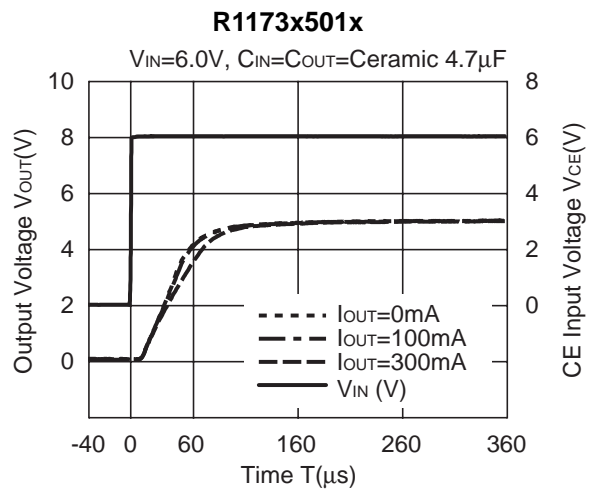
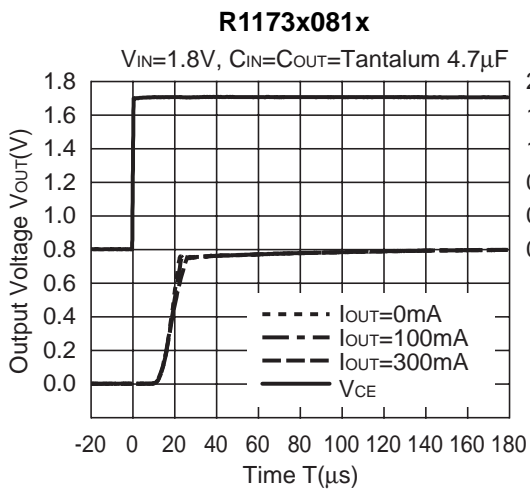

14) Turn-off speed with CE pin control

R1173x081D

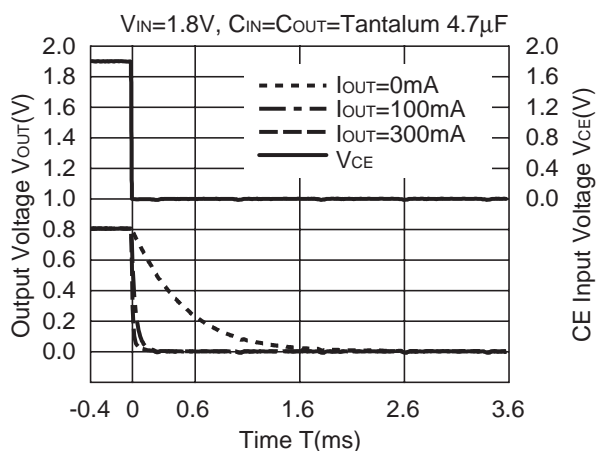

R1173x501D

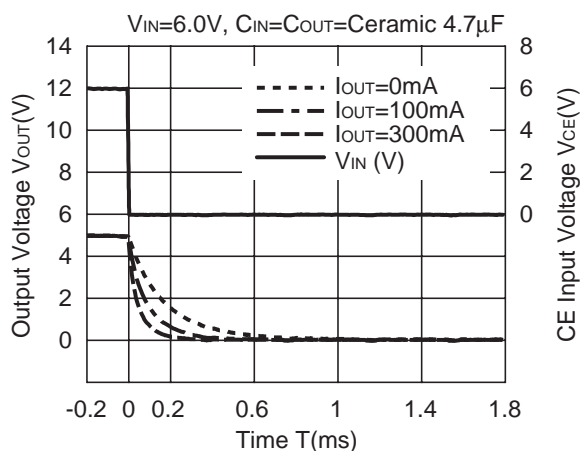

15) Inrush Current

R1173x081x

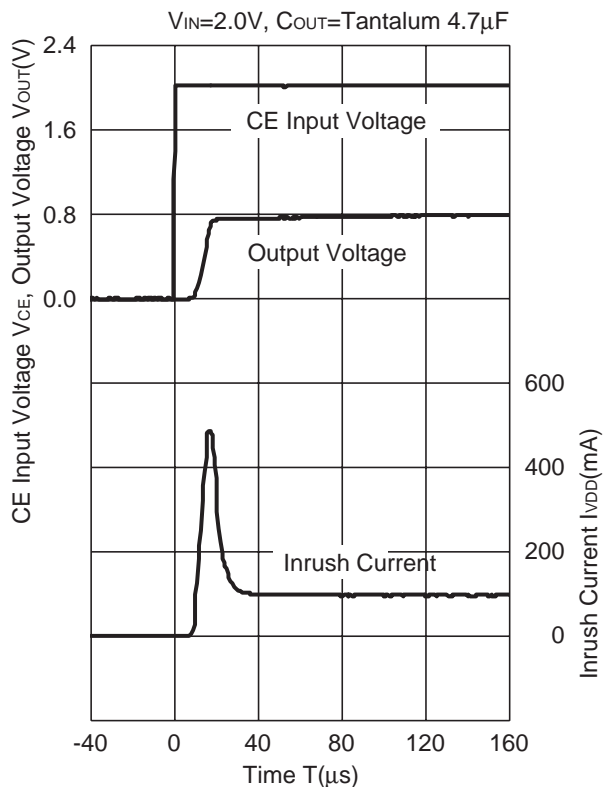

R1173x081x

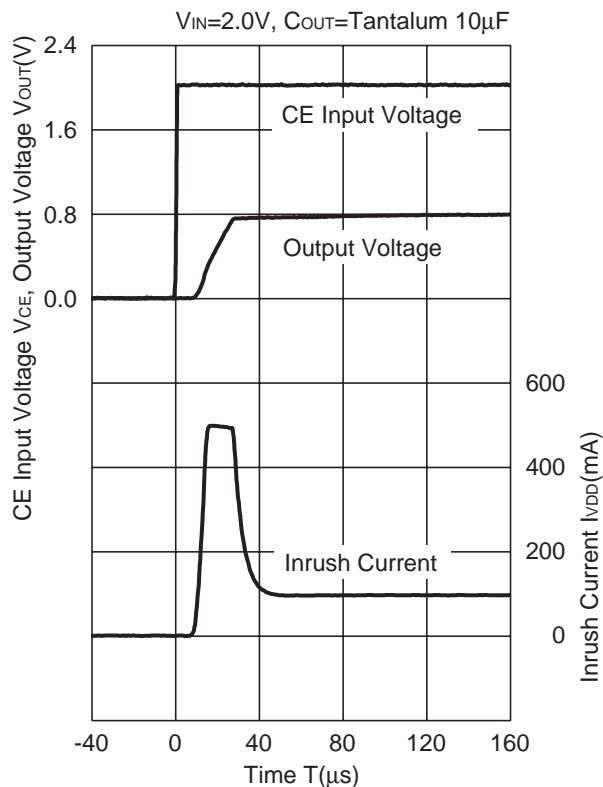

R1173x301x

$V_{IN}=4.0V$, $C_{OUT}=\text{Ceramic } 4.7\mu F$

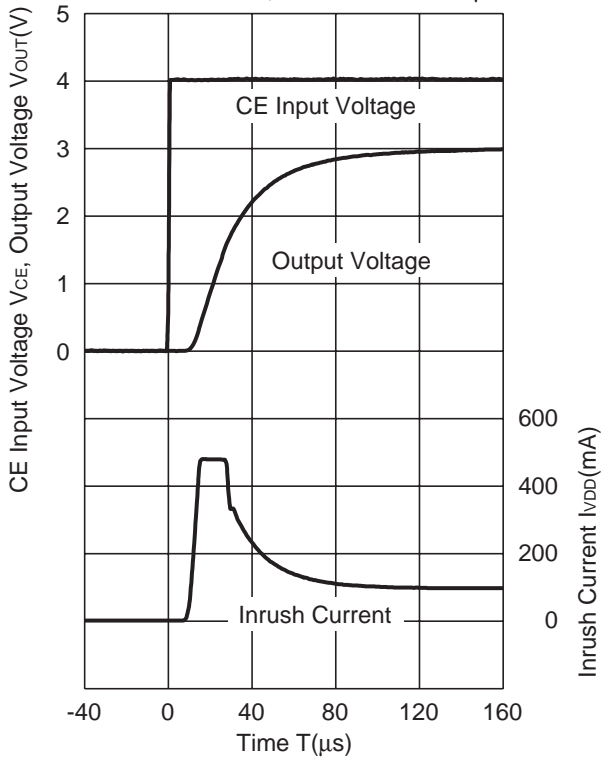

R1173x301x

$V_{IN}=4.0V$, $C_{OUT}=\text{Ceramic } 10\mu F$

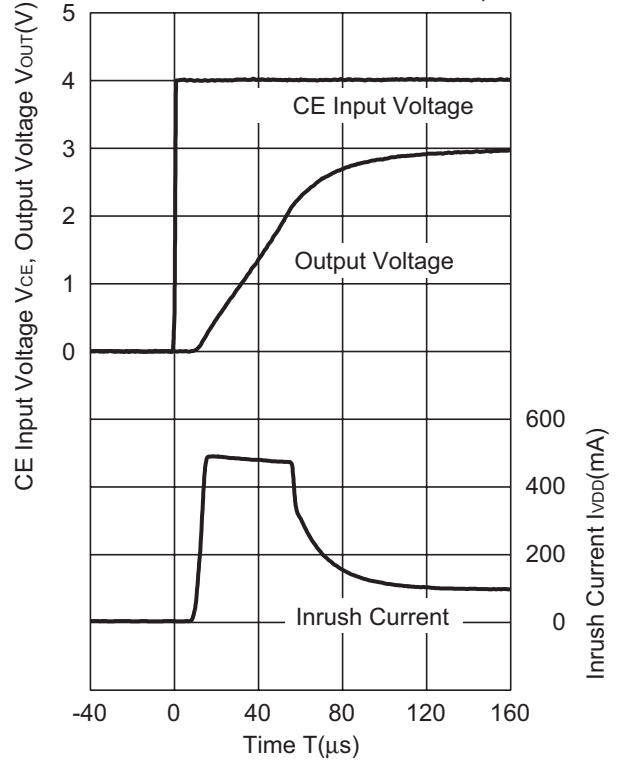

R1173x501x

$V_{IN}=6.0V$, $C_{OUT}=\text{Ceramic } 4.7\mu F$

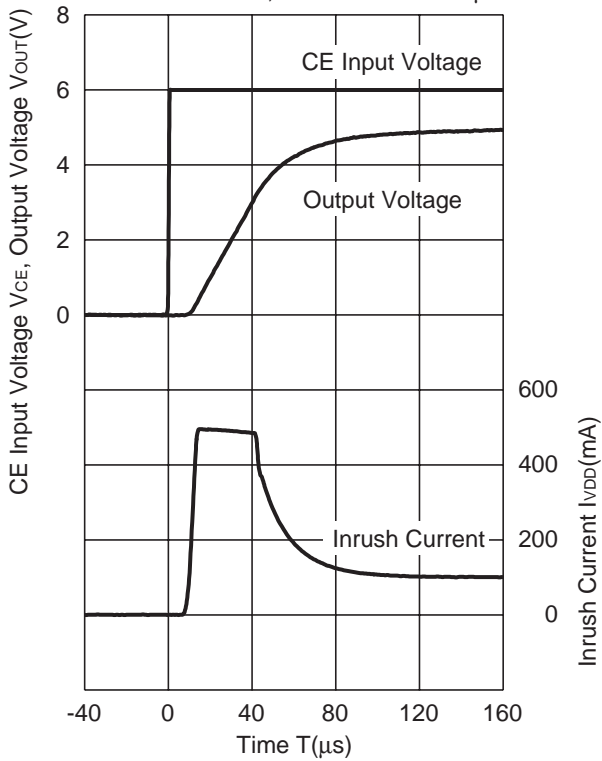

R1173x501x

$V_{IN}=6.0V$, $C_{OUT}=\text{Ceramic } 10\mu F$

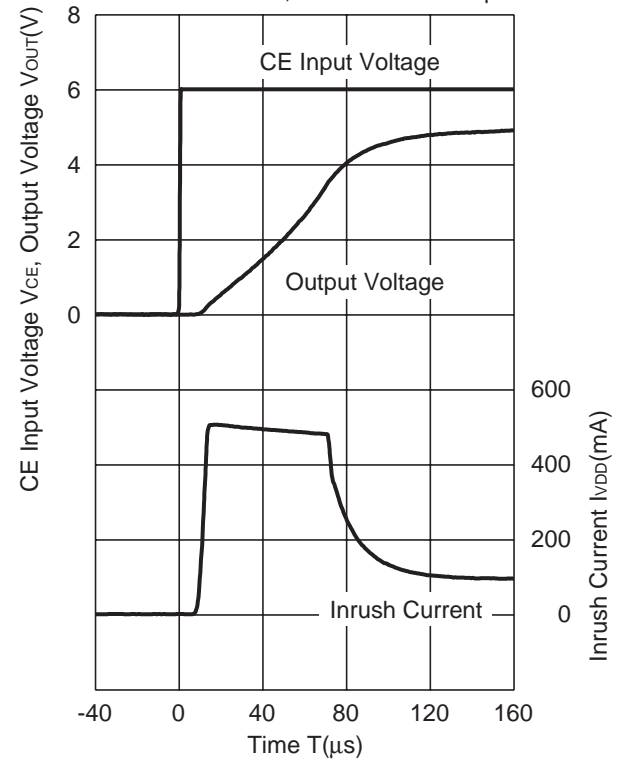

16) Stable Area: ESR limit vs. Load current

0.8V to 3.3V Output type : $C_{OUT}=4.7\mu F$ (Kyocera CM105X5R475M06AB)

5.0V Output type : $C_{OUT}=4.7\mu F$ (Kyocera CT21X5R475K06AB)

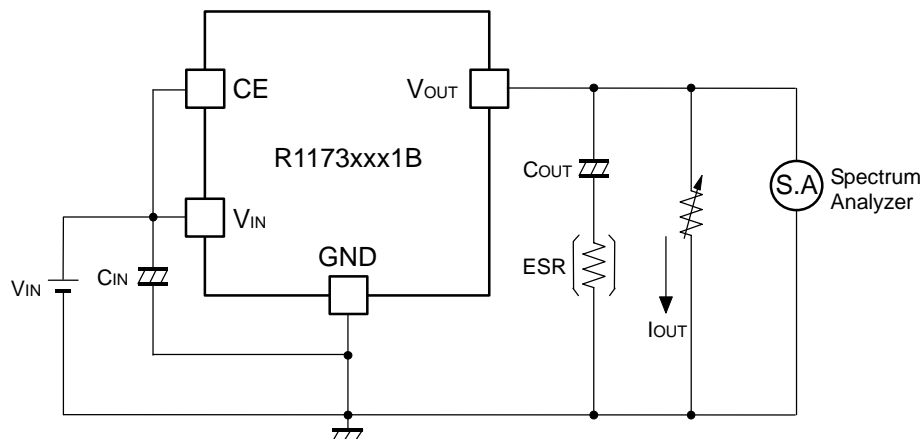

Measurement Conditions

- $V_{IN}=V_{OUT}+1V$
- Frequency=10Hz to 1MHz
- $T_{opt}=25^{\circ}C$

As an output capacitor for this IC, Ceramic capacitor is recommendable. However, other low ESR type capacitor can be used with this IC.

For your reference, noise level is tested, and if the noise level is $40\mu V$ or less than $40\mu V$, the ESR values are plotted as stable area. Upper limit is described in the next five graphs, or ESR vs. Output Current. (Hatched area is the stable area.)

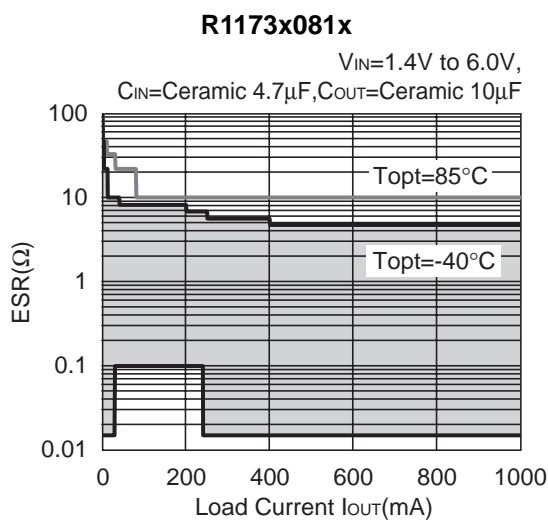
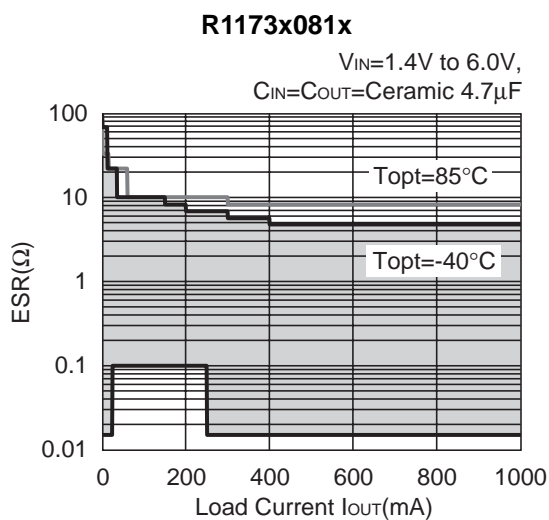

R1173x101x

$V_{IN}=1.4V$ to $6.0V$,
 $C_{IN}=C_{OUT}=\text{Ceramic } 4.7\mu F$

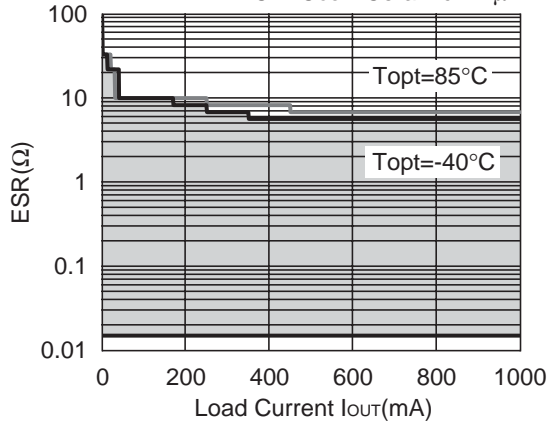

R1173x301x

$V_{IN}=3.1V$ to $6.0V$,
 $C_{IN}=C_{OUT}=\text{Ceramic } 4.7\mu F$

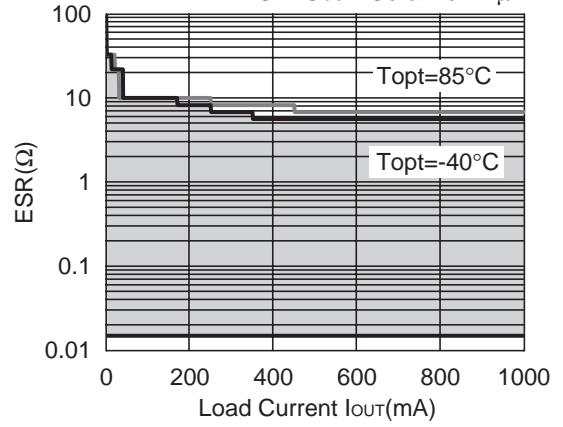

R1173x501x

$V_{IN}=3.1V$ to $6.0V$,
 $C_{IN}=C_{OUT}=\text{Ceramic } 4.7\mu F$

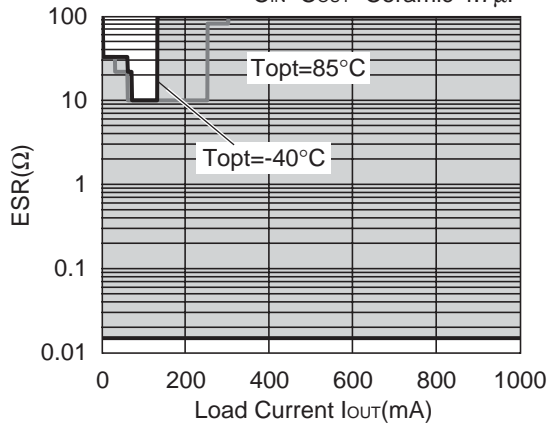

• SOT-89-5

Unit: mm

PACKAGE DIMENSIONS

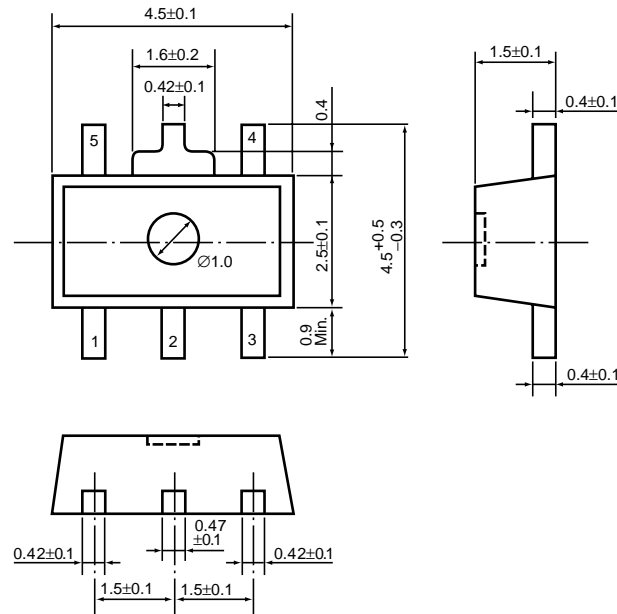

TAPING SPECIFICATION (T1: Standard Type)

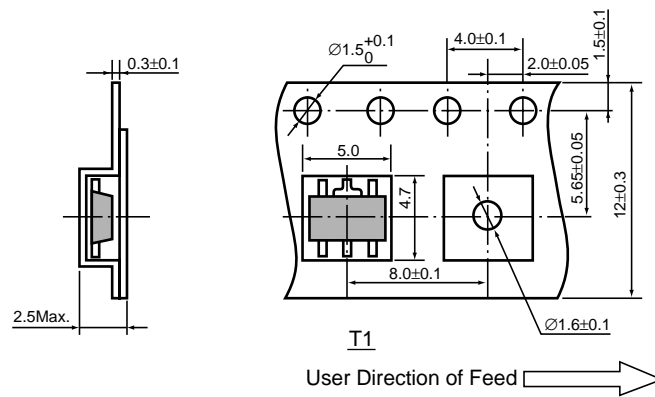

TAPING REEL DIMENSIONS REUSE REEL (EIAJ-RRM-12Bc)

(1reel=1000pcs)

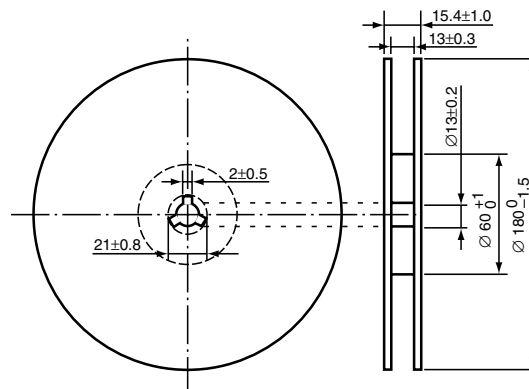

POWER DISSIPATION (SOT-89-5)

This specification is at mounted on board. Power Dissipation (P_D) depends on conditions of mounting on board. This specification is based on the measurement at the condition below:

Measurement Conditions

	High Wattage Land Pattern	Standard Land Pattern
Environment	Mounting on Board (Wind velocity=0m/s)	Mounting on Board (Wind velocity=0m/s)
Board Material	Glass cloth epoxy plastic (Double sided)	Glass cloth epoxy plastic (Double sided)
Board Dimensions	30mm × 30mm × 1.6mm	50mm × 50mm × 1.6mm
Copper Ratio	Top side : Approx. 20% , Back side : Approx. 100%	Top side : Approx. 10% , Back side : Approx. 100%
Through-hole	φ0.85mm × 10pcs	-

Measurement Result

($T_{opt}=25^{\circ}C, T_{jmax}=125^{\circ}C$)

	High Wattage Land Pattern	Standard Land Pattern	Free Air
Power Dissipation	1300mW	900mW	500mW
Thermal Resistance	77°C/W	111°C/W	200°C/W

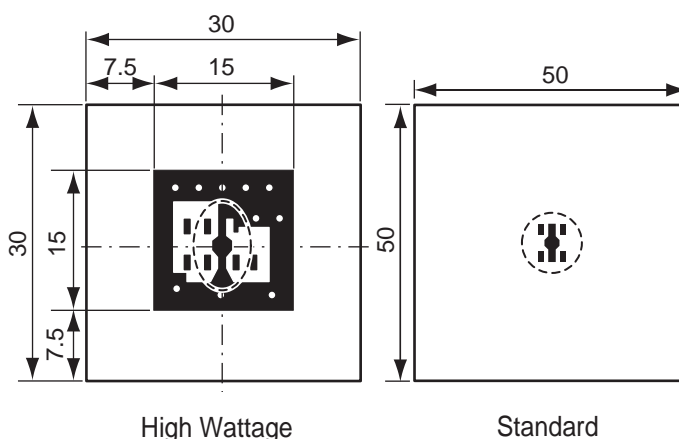
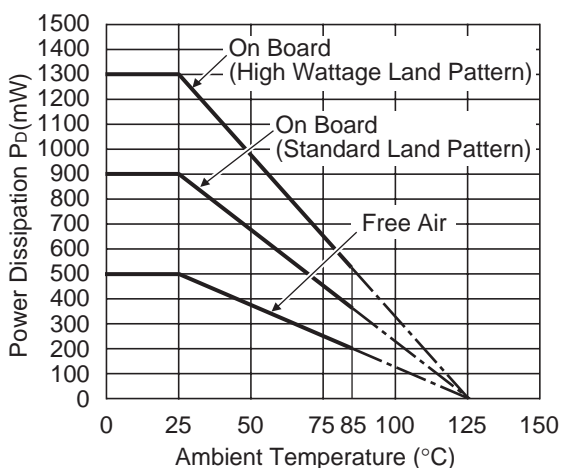

Measurement Board Pattern

○ IC Mount Area (Unit : mm)

RECOMMENDED LAND PATTERN (SOT-89-5)

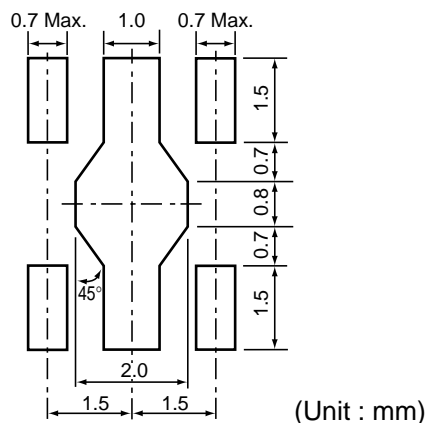

(Unit : mm)

• HSON-6

Unit: mm

PACKAGE DIMENSIONS

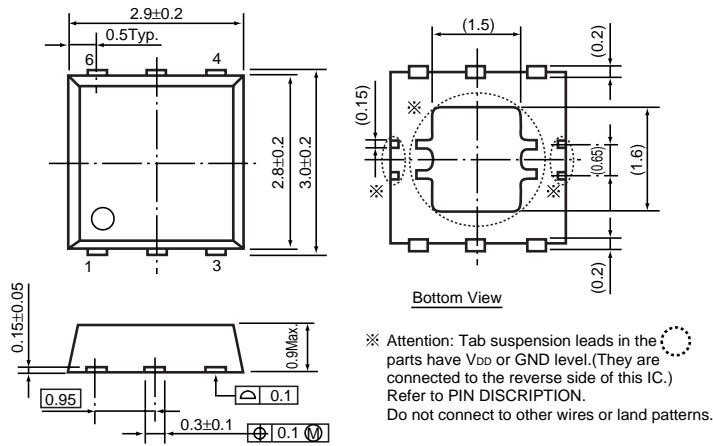

TAPING SPECIFICATION

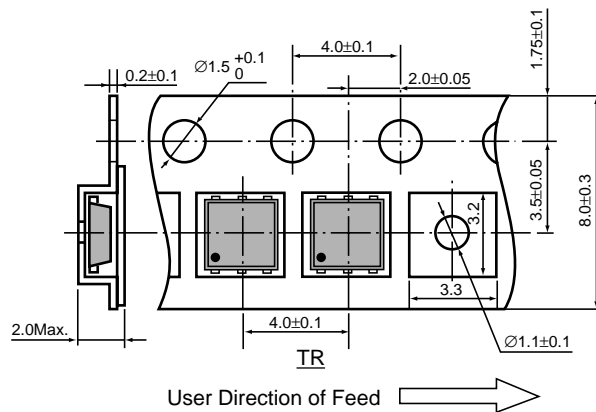

TAPING REEL DIMENSIONS REUSE REEL (EIAJ-RRM-08Bc)

(1reel=3000pcs)

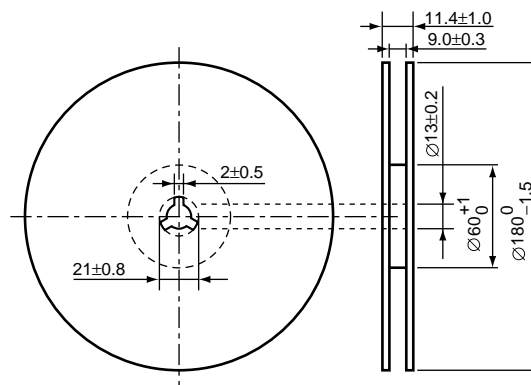

POWER DISSIPATION (HSON-6)

This specification is at mounted on board. Power Dissipation (P_D) depends on conditions of mounting on board. This specification is based on the measurement at the condition below:

Measurement Conditions

	Standard Land Pattern
Environment	Mounting on Board (Wind velocity=0m/s)
Board Material	Glass cloth epoxy plactic (Double sided)
Board Dimensions	40mm × 40mm × 1.6mm
Copper Ratio	Top side : Approx. 50% , Back side : Approx. 50%
Through-hole	φ0.5mm × 44pcs

Measurement Result

($T_{opt}=25^{\circ}\text{C}$, $T_{jmax}=125^{\circ}\text{C}$)

	Standard Land Pattern	Free Air
Power Dissipation	900mW	400mW
Thermal Resistance	$\theta_{ja}=(125-25^{\circ}\text{C})/0.9\text{W}=111^{\circ}\text{C/W}$	250°C/W

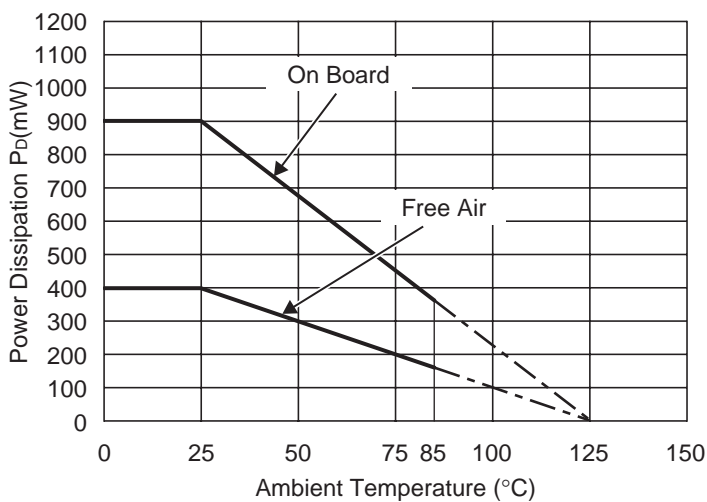

Power Dissipation

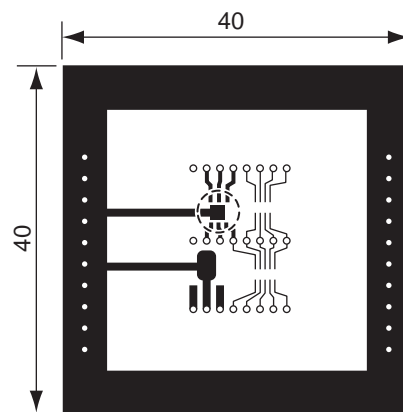

Measurement Board Pattern

○ IC Mount Area Unit : mm

RECOMMENDED LAND PATTERN

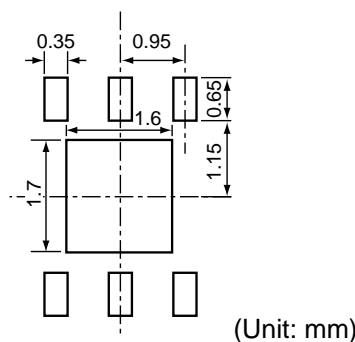

• HSOP-6J

Unit: mm

PACKAGE DIMENSIONS

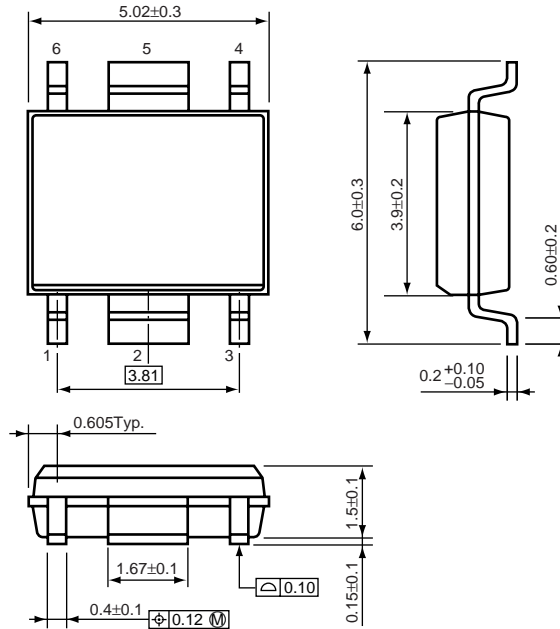

TAPING SPECIFICATION

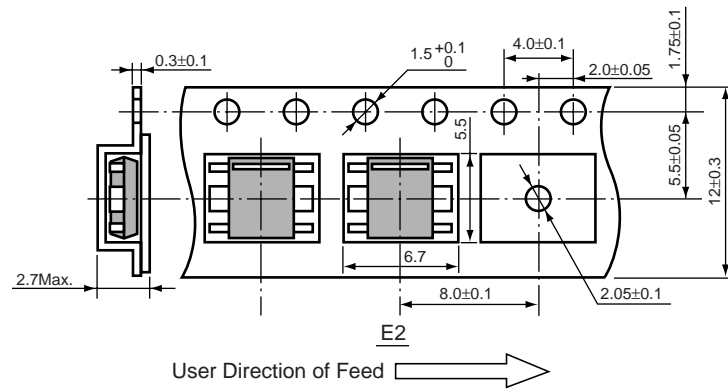

TAPING REEL DIMENSIONS REUSE REEL (EIAJ-RRM-12Bc)

(1reel=1000pcs)

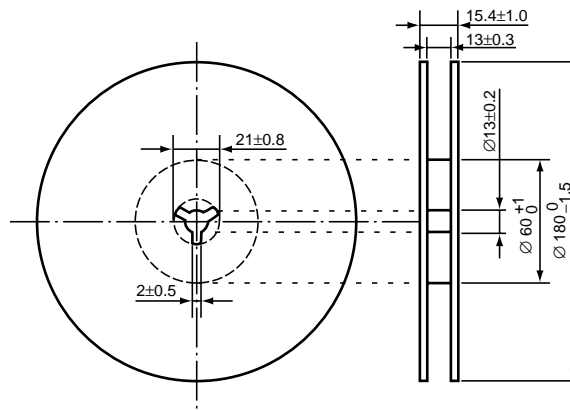

POWER DISSIPATION (HSOP-6J)

This specification is at mounted on board. Power Dissipation (P_D) depends on conditions of mounting on board. This specification is based on the measurement at the condition below:

Measurement Conditions

	High Wattage Land Pattern	Standard Land Pattern
Environment	Mounting on Board (Wind velocity=0m/s)	Mounting on Board (Wind velocity=0m/s)
Board Material	Glass cloth epoxy plactic (Double sided)	Glass cloth epoxy plactic (Double sided)
Board Dimensions	50mm × 50mm × 1.6mm	50mm × 50mm × 1.6mm
Copper Ratio	90%	50%
Through-hole	φ0.5mm × 44pcs	φ0.5mm × 44pcs

Measurement Result

($T_{opt}=25^{\circ}C, T_{jmax}=125^{\circ}C$)

	High Wattage Land Pattern	Standard Land Pattern	Free Air
Power Dissipation	2000mW	1700mW	540mW
Thermal Resistance	50°C/W	59°C/W	185°C/W

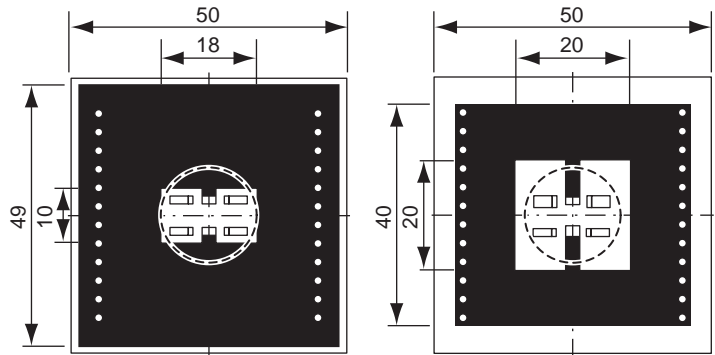
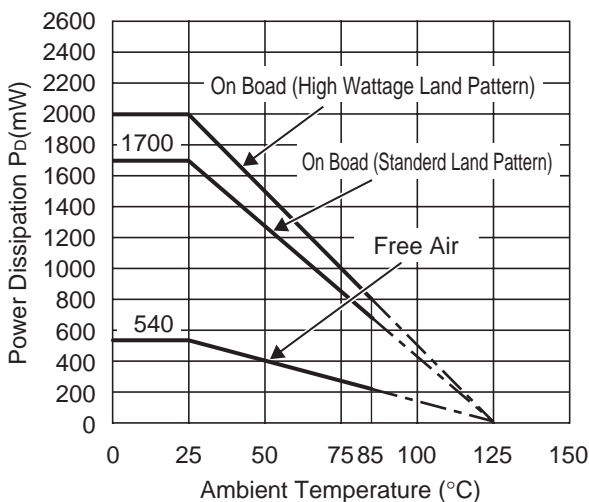

High Wattage Standard

Measurement Board Pattern

○ IC Mount Area Unit : mm

RECOMMENDED LAND PATTERN (HSOP-6J)

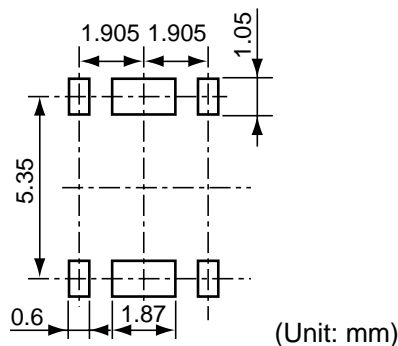

R1173H SERIES MARK SPECIFICATION

• SOT-89-5

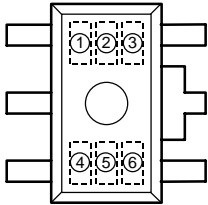

- ① : L (fixed)
- ②, ③ : Setting Voltage } (refer to Part Number vs. Product Code)
- ④ : Type (B,D)
- ⑤, ⑥ : Lot Number

• Part Number vs. Product Code

Part Number	Product Code			
	①	②	③	④
R1173H081B	L	0	8	B
R1173H091B	L	0	9	B
R1173H101B	L	1	0	B
R1173H111B	L	1	1	B
R1173H121B	L	1	2	B
R1173H131B	L	1	3	B
R1173H141B	L	1	4	B
R1173H151B	L	1	5	B
R1173H161B	L	1	6	B
R1173H171B	L	1	7	B
R1173H181B	L	1	8	B
R1173H191B	L	1	9	B
R1173H201B	L	2	0	B
R1173H211B	L	2	1	B
R1173H221B	L	2	2	B
R1173H231B	L	2	3	B
R1173H241B	L	2	4	B
R1173H251B	L	2	5	B
R1173H261B	L	2	6	B
R1173H271B	L	2	7	B
R1173H281B	L	2	8	B
R1173H291B	L	2	9	B
R1173H301B	L	3	0	B

Part Number	Product Code			
	①	②	③	④
R1173H311B	L	3	1	B
R1173H321B	L	3	2	B
R1173H331B	L	3	3	B
R1173H341B	L	3	4	B
R1173H351B	L	3	5	B
R1173H361B	L	3	6	B
R1173H371B	L	3	7	B
R1173H381B	L	3	8	B
R1173H391B	L	3	9	B
R1173H401B	L	4	0	B
R1173H411B	L	4	1	B
R1173H421B	L	4	2	B
R1173H431B	L	4	3	B
R1173H441B	L	4	4	B
R1173H451B	L	4	5	B
R1173H461B	L	4	6	B
R1173H471B	L	4	7	B
R1173H481B	L	4	8	B
R1173H491B	L	4	9	B
R1173H501B	L	5	0	B
R1173H181B5	L	0	1	B
R1173H281B5	L	0	2	B
R1173H001B	L	0	0	B

Part Number	Product Code			
	①	②	③	④
R1173H081D	L	0	8	D
R1173H091D	L	0	9	D
R1173H101D	L	1	0	D
R1173H111D	L	1	1	D
R1173H121D	L	1	2	D
R1173H131D	L	1	3	D
R1173H141D	L	1	4	D
R1173H151D	L	1	5	D
R1173H161D	L	1	6	D
R1173H171D	L	1	7	D
R1173H181D	L	1	8	D
R1173H191D	L	1	9	D
R1173H201D	L	2	0	D
R1173H211D	L	2	1	D
R1173H221D	L	2	2	D
R1173H231D	L	2	3	D
R1173H241D	L	2	4	D
R1173H251D	L	2	5	D
R1173H261D	L	2	6	D
R1173H271D	L	2	7	D
R1173H281D	L	2	8	D
R1173H291D	L	2	9	D
R1173H301D	L	3	0	D

Part Number	Product Code			
	①	②	③	④
R1173H311D	L	3	1	D
R1173H321D	L	3	2	D
R1173H331D	L	3	3	D
R1173H341D	L	3	4	D
R1173H351D	L	3	5	D
R1173H361D	L	3	6	D
R1173H371D	L	3	7	D
R1173H381D	L	3	8	D
R1173H391D	L	3	9	D
R1173H401D	L	4	0	D
R1173H411D	L	4	1	D
R1173H421D	L	4	2	D
R1173H431D	L	4	3	D
R1173H441D	L	4	4	D
R1173H451D	L	4	5	D
R1173H461D	L	4	6	D
R1173H471D	L	4	7	D
R1173H481D	L	4	8	D
R1173H491D	L	4	9	D
R1173H501D	L	5	0	D
R1173H181D5	L	0	1	D
R1173H281D5	L	0	2	D
R1173H001D	L	0	0	D

R1173D SERIES MARK SPECIFICATION

• HSON-6

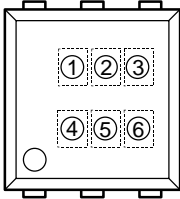

- ① : H (fixed)
- ②, ③ : Setting Voltage } (refer to Part Number vs. Product Code)
- ④ : Type (B,D)
- ⑤, ⑥ : Lot Number

• Part Number vs. Product Code

Part Number	Product Code			
	①	②	③	④
R1173D081B	H	0	8	B
R1173D091B	H	0	9	B
R1173D101B	H	1	0	B
R1173D111B	H	1	1	B
R1173D121B	H	1	2	B
R1173D131B	H	1	3	B
R1173D141B	H	1	4	B
R1173D151B	H	1	5	B
R1173D161B	H	1	6	B
R1173D171B	H	1	7	B
R1173D181B	H	1	8	B
R1173D191B	H	1	9	B
R1173D201B	H	2	0	B
R1173D211B	H	2	1	B
R1173D221B	H	2	2	B
R1173D231B	H	2	3	B
R1173D241B	H	2	4	B
R1173D251B	H	2	5	B
R1173D261B	H	2	6	B
R1173D271B	H	2	7	B
R1173D281B	H	2	8	B
R1173D291B	H	2	9	B
R1173D301B	H	3	0	B

Part Number	Product Code			
	①	②	③	④
R1173D311B	H	3	1	B
R1173D321B	H	3	2	B
R1173D331B	H	3	3	B
R1173D341B	H	3	4	B
R1173D351B	H	3	5	B
R1173D361B	H	3	6	B
R1173D371B	H	3	7	B
R1173D381B	H	3	8	B
R1173D391B	H	3	9	B
R1173D401B	H	4	0	B
R1173D411B	H	4	1	B
R1173D421B	H	4	2	B
R1173D431B	H	4	3	B
R1173D441B	H	4	4	B
R1173D451B	H	4	5	B
R1173D461B	H	4	6	B
R1173D471B	H	4	7	B
R1173D481B	H	4	8	B
R1173D491B	H	4	9	B
R1173D501B	H	5	0	B
R1173D181B5	H	0	1	B
R1173D281B5	H	0	2	B
R1173D001B	H	0	0	B

Part Number	Product Code			
	①	②	③	④
R1173D081D	H	0	8	D
R1173D091D	H	0	9	D
R1173D101D	H	1	0	D
R1173D111D	H	1	1	D
R1173D121D	H	1	2	D
R1173D131D	H	1	3	D
R1173D141D	H	1	4	D
R1173D151D	H	1	5	D
R1173D161D	H	1	6	D
R1173D171D	H	1	7	D
R1173D181D	H	1	8	D
R1173D191D	H	1	9	D
R1173D201D	H	2	0	D
R1173D211D	H	2	1	D
R1173D221D	H	2	2	D
R1173D231D	H	2	3	D
R1173D241D	H	2	4	D
R1173D251D	H	2	5	D
R1173D261D	H	2	6	D
R1173D271D	H	2	7	D
R1173D281D	H	2	8	D
R1173D291D	H	2	9	D
R1173D301D	H	3	0	D

Part Number	Product Code			
	①	②	③	④
R1173D311D	H	3	1	D
R1173D321D	H	3	2	D
R1173D331D	H	3	3	D
R1173D341D	H	3	4	D
R1173D351D	H	3	5	D
R1173D361D	H	3	6	D
R1173D371D	H	3	7	D
R1173D381D	H	3	8	D
R1173D391D	H	3	9	D
R1173D401D	H	4	0	D
R1173D411D	H	4	1	D
R1173D421D	H	4	2	D
R1173D431D	H	4	3	D
R1173D441D	H	4	4	D
R1173D451D	H	4	5	D
R1173D461D	H	4	6	D
R1173D471D	H	4	7	D
R1173D481D	H	4	8	D
R1173D491D	H	4	9	D
R1173D501D	H	5	0	D
R1173D181D5	H	0	1	D
R1173D281D5	H	0	2	D
R1173D001D	H	0	0	D

R1173S SERIES MARK SPECIFICATION

● HSOP-6J

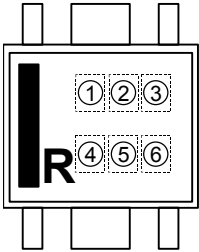

- ① : C (fixed)
 - ②, ③ : Setting Voltage
 - ④ : Type (B,D)
 - ⑤, ⑥ : Lot Number
- (refer to Part Number vs. Product Code)

● Part Number vs. Product Code

Part Number	Product Code			
	①	②	③	④
R1173S081B	C	0	8	B
R1173S091B	C	0	9	B
R1173S101B	C	1	0	B
R1173S111B	C	1	1	B
R1173S121B	C	1	2	B
R1173S131B	C	1	3	B
R1173S141B	C	1	4	B
R1173S151B	C	1	5	B
R1173S161B	C	1	6	B
R1173S171B	C	1	7	B
R1173S181B	C	1	8	B
R1173S191B	C	1	9	B
R1173S201B	C	2	0	B
R1173S211B	C	2	1	B
R1173S221B	C	2	2	B
R1173S231B	C	2	3	B
R1173S241B	C	2	4	B
R1173S251B	C	2	5	B
R1173S261B	C	2	6	B
R1173S271B	C	2	7	B
R1173S281B	C	2	8	B
R1173S291B	C	2	9	B
R1173S301B	C	3	0	B
R1173S311B	C	3	1	B
R1173S321B	C	3	2	B
R1173S331B	C	3	3	B
R1173S341B	C	3	4	B
R1173S351B	C	3	5	B
R1173S181B5	C	0	1	B
R1173S281B5	C	0	2	B
R1173S001B	C	0	0	B

Part Number	Product Code			
	①	②	③	④
R1173S081D	C	0	8	D
R1173S091D	C	0	9	D
R1173S101D	C	1	0	D
R1173S111D	C	1	1	D
R1173S121D	C	1	2	D
R1173S131D	C	1	3	D
R1173S141D	C	1	4	D
R1173S151D	C	1	5	D
R1173S161D	C	1	6	D
R1173S171D	C	1	7	D
R1173S181D	C	1	8	D
R1173S191D	C	1	9	D
R1173S201D	C	2	0	D
R1173S211D	C	2	1	D
R1173S221D	C	2	2	D
R1173S231D	C	2	3	D
R1173S241D	C	2	4	D
R1173S251D	C	2	5	D
R1173S261D	C	2	6	D
R1173S271D	C	2	7	D
R1173S281D	C	2	8	D
R1173S291D	C	2	9	D
R1173S301D	C	3	0	D
R1173S311D	C	3	1	D
R1173S321D	C	3	2	D
R1173S331D	C	3	3	D
R1173S341D	C	3	4	D
R1173S351D	C	3	5	D
R1173S181D5	C	0	1	D
R1173S281D5	C	0	2	D
R1173S001D	C	0	0	D

Компания «Океан Электроники» предлагает заключение долгосрочных отношений при поставках импортных электронных компонентов на взаимовыгодных условиях!

Наши преимущества:

- Поставка оригинальных импортных электронных компонентов напрямую с производств Америки, Европы и Азии, а так же с крупнейших складов мира;
- Широкая линейка поставок активных и пассивных импортных электронных компонентов (более 30 млн. наименований);
- Поставка сложных, дефицитных, либо снятых с производства позиций;
- Оперативные сроки поставки под заказ (от 5 рабочих дней);
- Экспресс доставка в любую точку России;
- Помощь Конструкторского Отдела и консультации квалифицированных инженеров;
- Техническая поддержка проекта, помощь в подборе аналогов, поставка прототипов;
- Поставка электронных компонентов под контролем ВП;
- Система менеджмента качества сертифицирована по Международному стандарту ISO 9001;
- При необходимости вся продукция военного и аэрокосмического назначения проходит испытания и сертификацию в лаборатории (по согласованию с заказчиком);
- Поставка специализированных компонентов военного и аэрокосмического уровня качества (Xilinx, Altera, Analog Devices, Intersil, Interpoint, Microsemi, Actel, Aeroflex, Peregrine, VPT, Syfer, Eurofarad, Texas Instruments, MS Kennedy, Miteq, Cobham, E2V, MA-COM, Hittite, Mini-Circuits, General Dynamics и др.);

Компания «Океан Электроники» является официальным дистрибьютором и эксклюзивным представителем в России одного из крупнейших производителей разъемов военного и аэрокосмического назначения «JONHON», а так же официальным дистрибьютором и эксклюзивным представителем в России производителя высокотехнологичных и надежных решений для передачи СВЧ сигналов «FORSTAR».



JONHON

«JONHON» (основан в 1970 г.)

Разъемы специального, военного и аэрокосмического назначения:

(Применяются в военной, авиационной, аэрокосмической, морской, железнодорожной, горно- и нефтедобывающей отраслях промышленности)

«FORSTAR» (основан в 1998 г.)

ВЧ соединители, коаксиальные кабели, кабельные сборки и микроволновые компоненты:

(Применяются в телекоммуникациях гражданского и специального назначения, в средствах связи, РЛС, а так же военной, авиационной и аэрокосмической отраслях промышленности).



Телефон: 8 (812) 309-75-97 (многоканальный)

Факс: 8 (812) 320-03-32

Электронная почта: ocean@oceanchips.ru

Web: <http://oceanchips.ru/>

Адрес: 198099, г. Санкт-Петербург, ул. Калинина, д. 2, корп. 4, лит. А