

Super low on resistance/Low voltage LDO

NO.EA-123-070828

OUTLINE

The R1173x Series are CMOS-based positive voltage regulator ICs. The R1173x Series have features of super low dropout, 1A output current capability, and -3mV typical load regulation at 1A. Even the output voltage is set at 1.5V, on resistance of internal FET is typically 0.32Ω. Therefore, applications that require a large current at small dropout are suitable for the R1173x series. Low input voltage is acceptable and low output voltage can be set. The minimum input voltage is 1.4V, and the lowest set output voltage is 0.8V. Each of these ICs consists of a voltage reference unit, an error amplifier, resistor net for setting output voltage, a current limit circuit at over-current, a chip enable circuit, a thermal-shutdown circuit, and so on. A stand-by mode with ultra low consumption current can be realized with the chip enable pin. The output voltage types of R1173 are fixed one in the IC and adjustable one (R1173x001x).

Since the packages for these ICs are the SOT-89-5 package, HSON-6, or HSOP-6J, high density mounting of the ICs on boards is possible.

FEATURES

- Output Current 1A
- Supply Current Typ. 60μA
- Standby Current Typ. 0.1μA
- Input Voltage Range 1.4V to 6.0V
- Output Voltage Range (R1173xxx1) 0.8V to 5.0V (HSOP-6J: 0.8V to 3.5V)
- Output Voltage Range (R1173x001) 1.0V to V_{IN}
- Dropout Voltage Typ. 0.32V ($V_{OUT}=1.5V, I_{OUT}=1A$)
Typ. 0.18V ($V_{OUT}=2.8V, I_{OUT}=1A$)
- Ripple Rejection Typ. 70dB ($V_{OUT}=2.8V$)
- Output Voltage Accuracy ±2.0%
- Temperature-drift Coefficient of Output Voltage Typ. ±100ppm/°C
- Line Regulation Typ. 0.05%/V
- Load Regulation Typ. -2mV ($I_{OUT}=300mA$)
Typ. -3mV ($I_{OUT}=1A$)
- Packages SOT-89-5, HSON-6, HSOP-6J
- Low inrush current at turning-on Typ. 500mA
- Built-in Current Limit Circuit Typ. 250mA
- Output capacitors C_{IN} =Ceramic 4.7μF
 C_{OUT} =Tantalum 4.7μF ($V_{OUT}<1.0V$)
 C_{OUT} =Ceramic 4.7μF ($V_{OUT} \geq 1.0V$)
- Built-in Thermal Shutdown Circuit

APPLICATIONS

- Local Power source for Notebook PC.
- Local Power source for portable communication equipments, cameras, and videos.
- Local Power source for home appliances.

BLOCK DIAGRAMS

R1173xxx1B

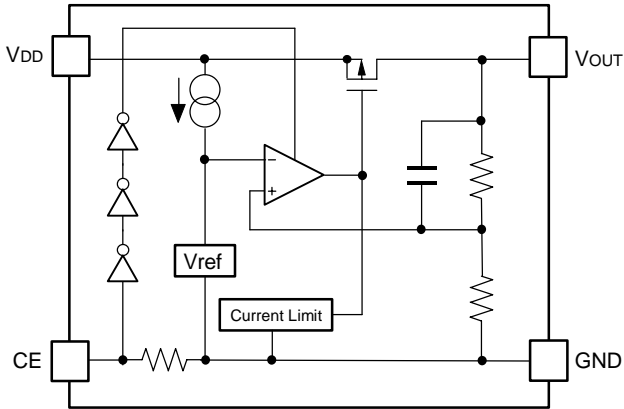

R1173xxx1D

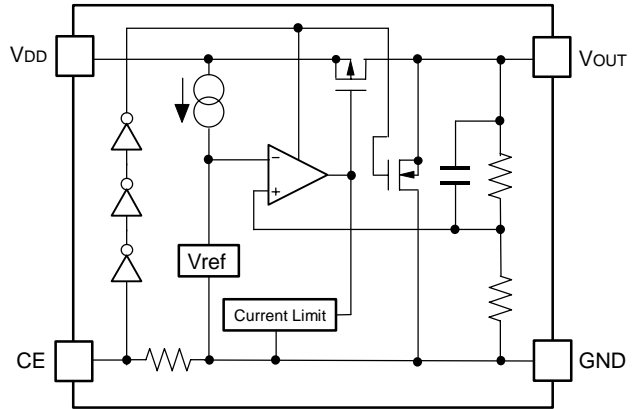

R1173x001B

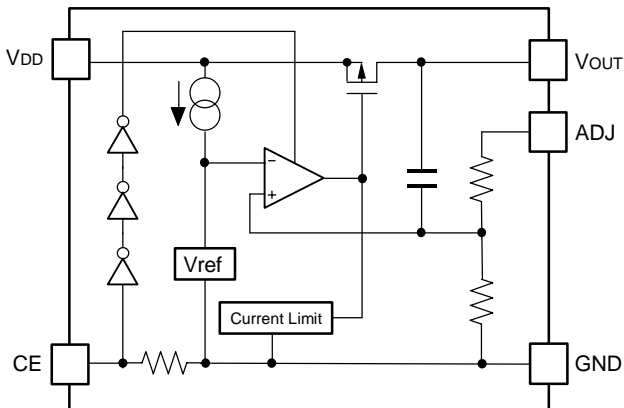

R1173x001D

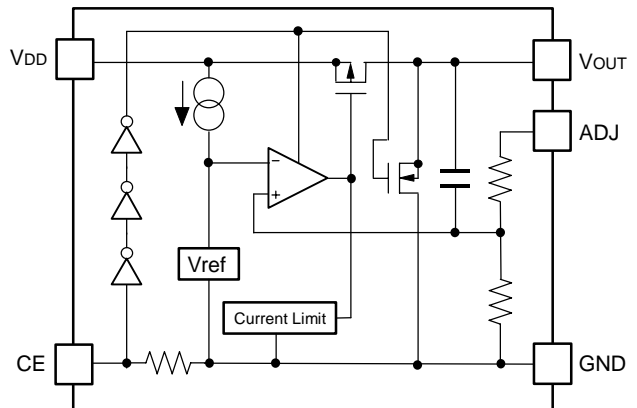

SELECTION GUIDE

The output voltage, auto discharge function*, the package type, etc. can be selected at the user's request.
The selection can be made with the part number as follows;

R1173xxx1x-xx-X ←Part Number
 ↑↑ ↑↑ ↑
 a b c d e

| Code | Contents |
|------|---|
| A | Package Type; H: SOT-89-5, D: HSON-6, S: HSOP-6J |
| b | Designation of Output Voltage (V_{OUT}) External Setting Type: 00 (ADJ pin voltage is fixed at 1.0V.) Fixed Type: 08 to 50 (Stepwise setting with 0.1V increment in the range from 0.8V to 5.0V, exceptions; 1.85V output: R1173x181x5-xx, 2.85V output: R1173x281x5-xx) |
| c | Designation of Mask Option: B: Built-in Chip Enable Circuit, Active at "H", without auto discharge function* D: Built-in Chip Enable Circuit, Active at "H", with auto discharge function* |
| d | Designation of Taping Type; T1 (SOT-89-5), TR (HSON-6), E2 (HSOP-6J) (Refer to Taping Specifications) |
| e | Designation of composition of plating: -F: Lead free plating (SOT-89-5, HSON-6, HSOP-6J) |

*) When the mode is into standby with CE signal, auto discharge transistor turns on, and it makes the turn-off speed faster than normal type.

PIN CONFIGURATIONS

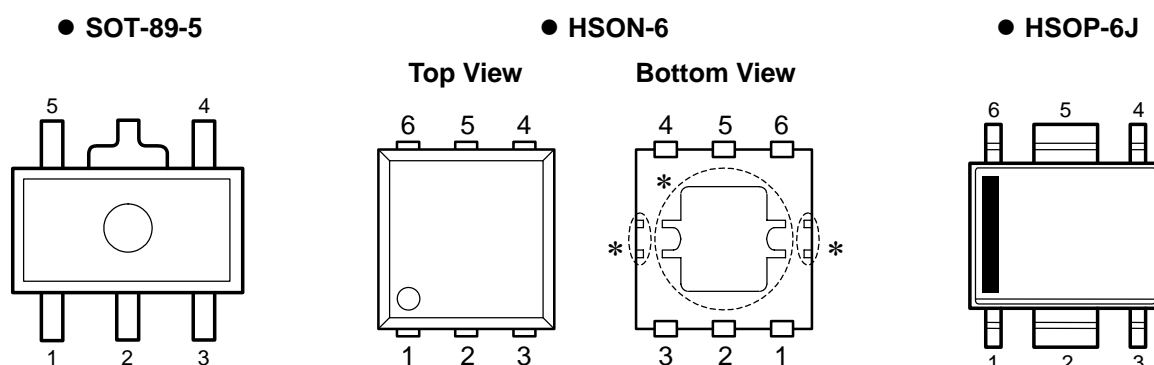

PIN DESCRIPTIONS

●SOT-89-5

| Pin No. | Symbol | Description |
|---------|------------------|----------------------------|
| 1 | ADJ or NC | ADJUST Pin (R1173H001x) |
| | | No Connection (R1173Hxx1x) |
| 2 | GND | Ground Pin |
| 3 | CE | Chip Enable Pin |
| 4 | V _{DD} | Input Pin |
| 5 | V _{OUT} | Output Pin |

●HSON-6

| Pin No. | Symbol | Description |
|---------|------------------|----------------------------|
| 1 | V _{OUT} | Output Pin |
| 2 | V _{OUT} | Output Pin |
| 3 | ADJ or NC | ADJUST Pin (R1173D001x) |
| | | No Connection (R1173Dxx1x) |
| 4 | GND | Ground Pin |
| 5 | CE | Chip Enable Pin |
| 6 | V _{DD} | Input Pin |

* Tab in the  parts have GND level. (They are connected to the back side of this IC.)
Connect Pin1 and Pin2 as short as possible.

●HSOP-6J

| Pin No. | Symbol | Description |
|---------|------------------|----------------------------|
| 1 | V _{OUT} | Output Pin |
| 2 | GND | Ground Pin |
| 3 | ADJ or NC | ADJUST Pin (R1173S001x) |
| | | No Connection (R1173Sxx1x) |
| 4 | CE | Chip Enable Pin |
| 5 | GND | Ground Pin |
| 6 | V _{DD} | Input Pin |

ABSOLUTE MAXIMUM RATINGS

| Symbol | Item | Rating | Unit |
|------------------|--|------------------------------|------|
| V _{IN} | Input Voltage | 6.5 | V |
| V _{CE} | Input Voltage (CE Input Pin) | -0.3 to 6.5 | V |
| V _{OUT} | Output Voltage | -0.3 to V _{IN} +0.3 | V |
| I _{OUT} | Output Current | 1.4 | A |
| P _D | Power Dissipation (SOT-89-5)* ¹ | 900 | mW |
| | Power Dissipation (HSON-6)* ¹ | 900 | |
| | Power Dissipation (HSOP-6J)* ¹ | 1700 | |
| T _{opt} | Operating Temperature | -40 to 85 | °C |
| T _{stg} | Storage Temperature | -55 to 125 | °C |

*1) For Power Dissipation, please refer to PACKAGE INFORMATION to be described.

ELECTRICAL CHARACTERISTICS

• R1173xxxxB/D (Fixed Output Voltage Type)

T_{opt}=25°C

| Symbol | Item | Conditions | Min. | Typ. | Max. | Unit |
|--|--|---|-------------------------|----------|-------|------------|
| V _{IN} | Input Voltage | | 1.4 | | 6.0 | V |
| I _{SS} | Supply Current | V _{IN} -V _{OUT} =1.0V, V _{CE} =V _{IN} , I _{OUT} =0A | | 60 | 100 | μA |
| I _{standby} | Standby Current | V _{IN} = 6.0V, V _{CE} =0V | | 0.1 | 1.0 | μA |
| V _{OUT} | Output voltage | V _{IN} -V _{OUT} =1.0V I _{OUT} =100mA | V _{OUT} >1.5V | ×0.98 | ×1.02 | V |
| | | | V _{OUT} ≤ 1.5V | -30 | +30 | mV |
| I _{OUT} | Output Current | V _{IN} -V _{OUT} =1.0V | 1 | | | A |
| ΔV _{OUT} / ΔI _{OUT} | Load regulation | V _{IN} -V _{OUT} =0.3V, 1mA ≤ I _{OUT} ≤ 300mA If V _{OUT} ≤ 1.1V, then V _{IN} =1.4V | -15 | -2 | 15 | mV |
| | | V _{IN} -V _{OUT} =0.3V, 1mA ≤ I _{OUT} ≤ 1A If V _{OUT} ≤ 1.1V, then V _{IN} =1.7V | | -3 | | |
| V _{DIF} | Dropout Voltage | Refer to the following table | | | | |
| ΔV _{OUT} / ΔV _{IN} | Line regulation | I _{OUT} =100mA, V _{OUT} +0.5V ≤ V _{IN} ≤ 6.0V If V _{OUT} ≤ 0.9V, 1.4V ≤ V _{IN} ≤ 6.0V | | 0.05 | 0.20 | %/V |
| RR | Ripple Rejection | f=1kHz (V _{OUT} ≤ 4.0V) f=1kHz (V _{OUT} >4.0V) Ripple 0.5Vp-p, V _{IN} -V _{OUT} =1.0V, I _{OUT} =100mA If V _{OUT} ≤ 1.2V, V _{IN} -V _{OUT} =1.5V, I _{OUT} =100mA | | 70 60 | | dB |
| ΔV _{OUT} / ΔT _{opt} | Output Voltage Temperature Coefficient | I _{OUT} =100mA, -40°C ≤ T _{opt} ≤ 85°C | | ±100 | | ppm/ °C |
| I _{lim} | Short Current Limit | V _{OUT} =0V | | 250 | | mA |
| R _{PD} | Pull-down resistance for CE pin | | 1.9 | 5.0 | 15.0 | MΩ |
| V _{CEH} | CE Input Voltage "H" | | 1.0 | | 6.0 | V |
| V _{CEL} | CE Input Voltage "L" | | 0 | | 0.4 | V |
| T _{TSD} | Thermal Shutdown Detector Threshold Temperature | Junction Temperature | | 150 | | °C |
| T _{TSR} | Thermal Shutdown Released Temperature | Junction Temperature | | 120 | | °C |
| en | Output Noise | BW=10Hz to 100kHz | | 30 | | μVrms |

• Dropout Voltage by Output Voltage

T_{opt}=25°C

| Output Voltage V _{OUT} (V) | Dropout Voltage V _{DIF} (V) | | |
|--|--------------------------------------|------|----------------------|
| | I _{OUT} =300mA | | I _{OUT} =1A |
| | Typ. | Max. | Typ. |
| 0.8 ≤ V _{OUT} < 0.9 | 0.33 | 0.57 | 0.72 |
| 0.9 ≤ V _{OUT} < 1.0 | 0.22 | 0.47 | 0.64 |
| 1.0 ≤ V _{OUT} < 1.5 | 0.18 | 0.32 | 0.56 |
| 1.5 ≤ V _{OUT} < 2.6 | 0.10 | 0.15 | 0.32 |
| 2.6 ≤ V _{OUT} | 0.05 | 0.10 | 0.18 |

R1173x

- R1173x001B/D (Adjustable Output Voltage Type)

T_{opt}=25°C

| Symbol | Item | Conditions | Min. | Typ. | Max. | Unit | |
|--|--|---|-------------------------|-------|-----------------|--------|---|
| V _{IN} | Input Voltage | | 1.4 | | 6.0 | V | |
| I _{SS} | Supply Current | V _{OUT} =V _{ADJ} , V _{IN} =2.0, V _{CE} =V _{IN} | | 60 | 100 | μA | |
| I _{standby} | Standby Current | V _{IN} =6.0V, V _{CE} =0V | | 0.1 | 1.0 | μA | |
| V _{OUT} | Reference Voltage for Adjustable Voltage Regulator | V _{OUT} =V _{ADJ} , V _{IN} =2.0V I _{OUT} =100mA | 0.970 | 1.000 | 1.030 | V | |
| RV _{OUT} | Output Voltage Range | | 1.0 | | V _{IN} | V | |
| I _{OUT} | Output Current | V _{OUT} =V _{ADJ} , V _{IN} =2.0 | 1 | | | A | |
| ΔV _{OUT} / ΔI _{OUT} | Load regulation | V _{IN} =1.4V 1mA ≤ I _{OUT} ≤ 300mA | -15 | -2 | 15 | mV | |
| | | V _{IN} =1.7V 1mA ≤ I _{OUT} ≤ 1A | | -3 | | | |
| V _{DIF} | Dropout Voltage | V _{OUT} =V _{ADJ} | I _{OUT} =300mA | | 0.18 | 0.32 | V |
| | | | I _{OUT} =1A | | 0.56 | | |
| ΔV _{OUT} / ΔV _{IN} | Line regulation | V _{OUT} =V _{ADJ} , I _{OUT} =100mA 1.5V ≤ V _{IN} ≤ 6.0V | | 0.05 | 0.20 | %/V | |
| RR | Ripple Rejection | f=1kHz Ripple 0.5Vp-p, V _{OUT} =V _{ADJ} , V _{IN} =2.5V I _{OUT} =100mA | | 70 | | dB | |
| ΔV _{OUT} / ΔT _{opt} | Output Voltage Temperature Coefficient | I _{OUT} =100mA -40°C ≤ T _{opt} ≤ 85°C | | ±100 | | ppm/°C | |
| I _{lim} | Short Current Limit | V _{OUT} =V _{ADJ} =0V | | 250 | | mA | |
| R _{PD} | Pull-down resistance for CE pin | | 1.9 | 5.0 | 15.0 | MΩ | |
| V _{CEH} | CE Input Voltage "H" | | 1.0 | | 6.0 | V | |
| V _{CEL} | CE Input Voltage "L" | | 0 | | 0.4 | V | |
| T _{TSD} | Thermal Shutdown Detector Threshold Temperature | Junction Temperature | | 150 | | °C | |
| T _{TSR} | Thermal Shutdown Released Temperature | Junction Temperature | | 120 | | °C | |
| en | Output Noise | BW=10Hz to 100kHz | | 30 | | μVrms | |

Technical Notes on External Components and Typical Application

(Refer to the example of typical application)

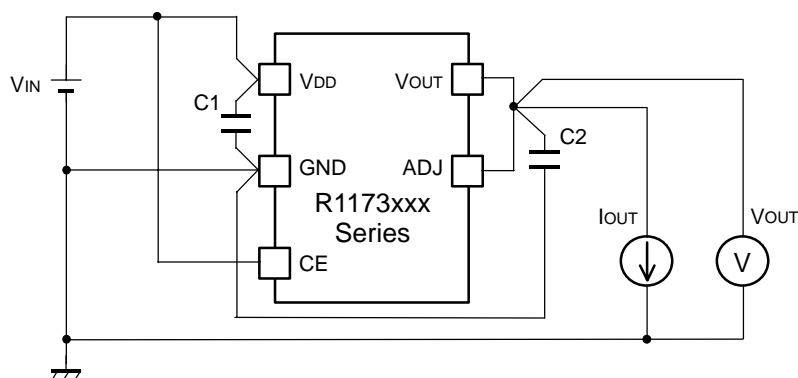

Example of the typical application of R1173x (Fixed Output Type)

Phase Compensation

In these ICs, phase compensation is made with the output capacitor for securing stable operation even if the load current is varied. For this purpose, use as much as a capacitor as C2. Recommendation value is as follows:

Mounting on PCB

Make V_{DD} and GND lines sufficient. If their impedance is high, a current flows, the noise picked up or unstable operation may result. Further use a $4.7\mu\text{F}$ or more value capacitor between V_{DD} pin and GND pin as close as possible.

Set an Output capacitor between V_{OUT} pin and GND pin for phase compensation as close as possible.

| Output Voltage | C2 recommendation value | Components Recommendation | |
|----------------------------------|-----------------------------------|--|---|
| $V_{OUT} < 1.0\text{V}$ | Tantalum $4.7\mu\text{F}$ or more | | |
| $1.0 \leq V_{OUT} < 3.3\text{V}$ | Ceramic $4.7\mu\text{F}$ or more | Kyocera $4.7\mu\text{F}$ (1608) Murata $4.7\mu\text{F}$ (1608) Murata $10\mu\text{F}$ (1608) | Part Number: CM105X5R475M06AB Part Number: GRM188R60J475KE19B Part Number: GRM188B30G106ME46B |
| $3.3\text{V} \leq V_{OUT}$ | Ceramic $4.7\mu\text{F}$ or more | Kyocera $4.7\mu\text{F}$ (thin 2012) Murata $10\mu\text{F}$ (1608) | Part Number: CT21X5R475M06AB Part Number: GRM188B30G106ME46B |

If you use a tantalum type capacitor and ESR value of the capacitor is large, output might be unstable. Evaluate your circuit with considering frequency characteristics.

Depending on the capacitor size, manufacturer, and part number, the bias characteristics and temperature characteristics are different. Evaluate the circuit with actual using capacitors.

Technical Notes on Output Voltage Setting of Adjustable Output type (R1173x001x)

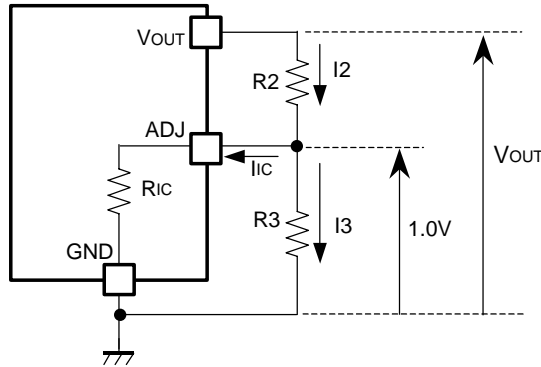

The Output Voltage may be adjustable for any output voltage between its 1.0V reference and its V_{DD} setting level. An external pair of resistors is required, as shown above.

The complete equation for the output voltage is described step by step as follows;

$$I_2 = I_{IC} + I_3 \dots\dots\dots (1)$$

$$I_3 = 1.0/R_3 \dots\dots\dots (2)$$

Thus,

$$I_2 = I_{IC} + 1.0/R_3 \dots\dots\dots (3)$$

Therefore,

$$V_{OUT} = 1.0 + R_2 \times I_2 \dots\dots\dots (4)$$

Put Equation (3) into Equation (4), then

$$\begin{aligned} V_{OUT} &= 1.0 + R_2(I_{IC} + 1.0/R_3) \\ &= 1.0(1 + R_2/R_3) + R_2 \times I_{IC} \dots\dots\dots (5) \end{aligned}$$

In 2nd term, or $R_2 \times I_{IC}$ will produce an error in V_{OUT} .

In Equation (5),

$$I_{IC} = 1.0/R_{IC} \dots\dots\dots (6)$$

$$\begin{aligned} R_2 \times I_{IC} &= R_2 \times 1.0/R_{IC} \\ &= 1.0 \times R_2/R_{IC} \dots\dots\dots (7) \end{aligned}$$

For better accuracy, choosing $R_2 \ll R_{IC}$ reduces this error.

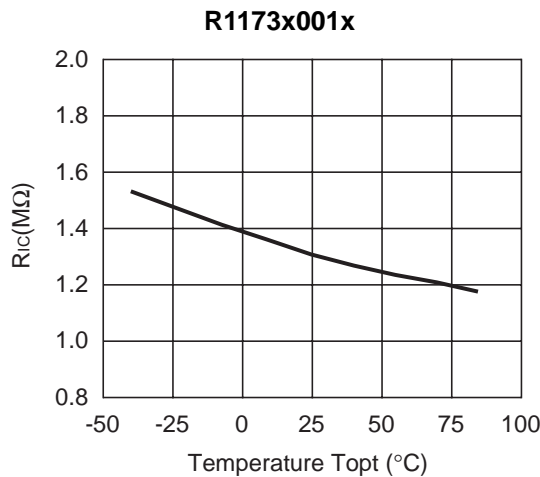

*) The graph is a typical characteristic, please evaluate the circuit with an actual condition.

TYPICAL CHARACTERISTICS

1) Output Voltage vs. Output Current (Topt=25°C)

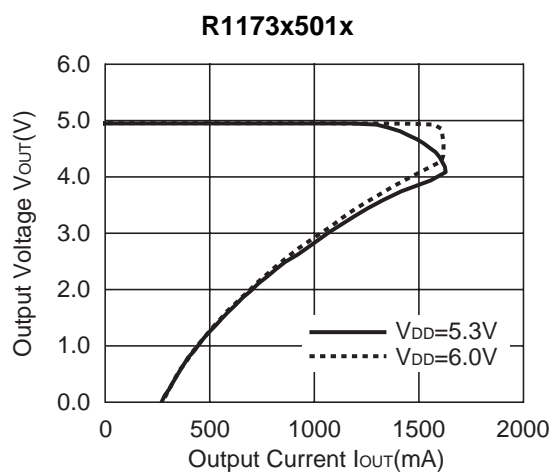
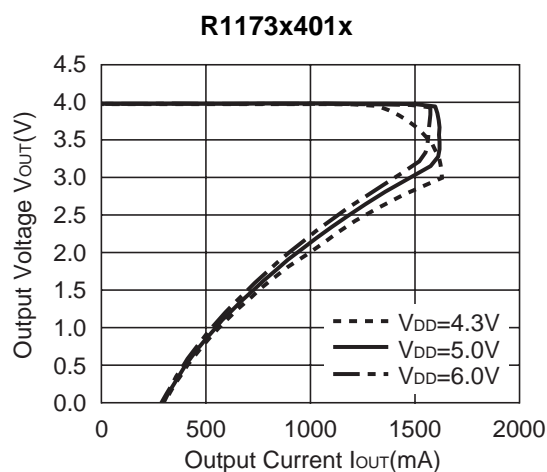
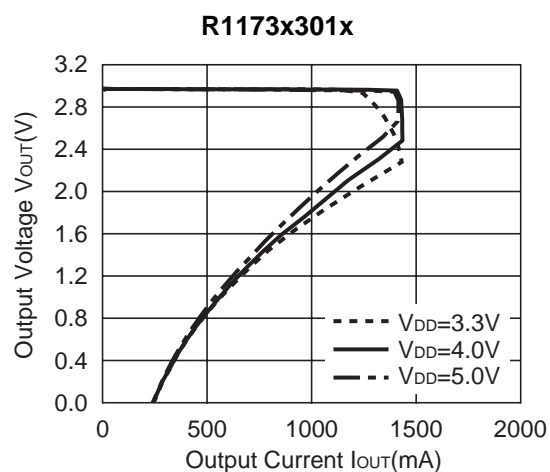
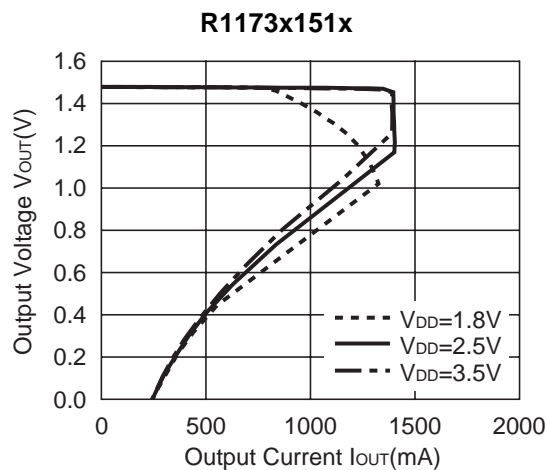
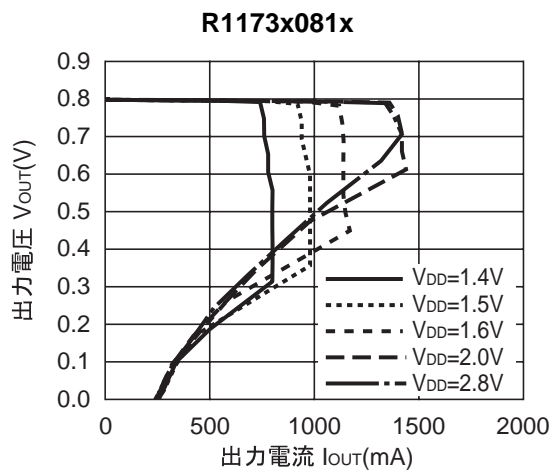

2) Output Voltage vs. Input Voltage (T_{opt}=25°C)

R1173x081x

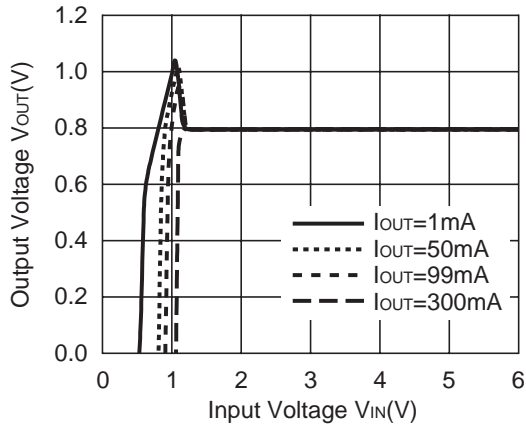

R1173x151x

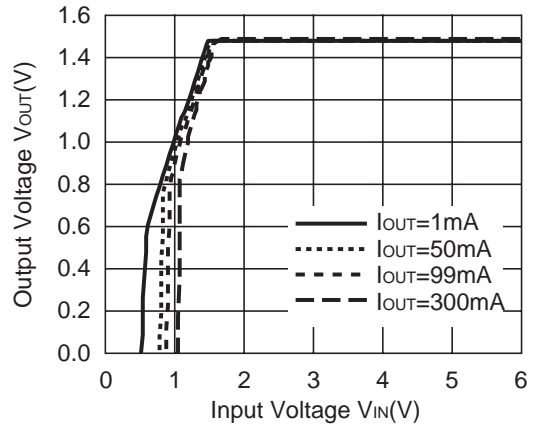

R1173x301x

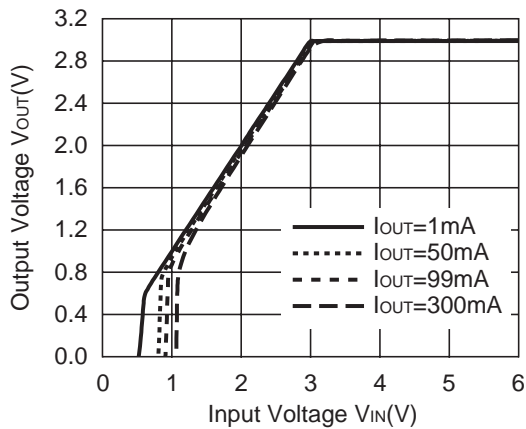

R1173x401x

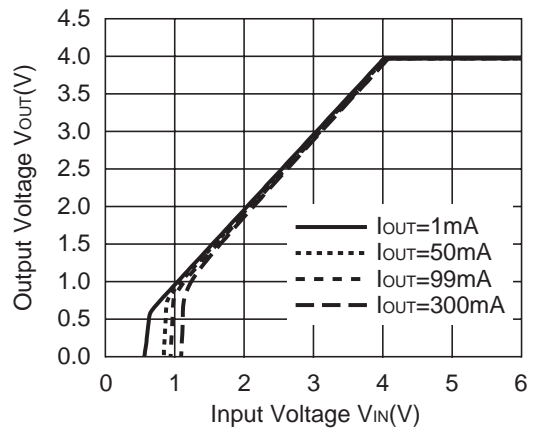

R1173x501x

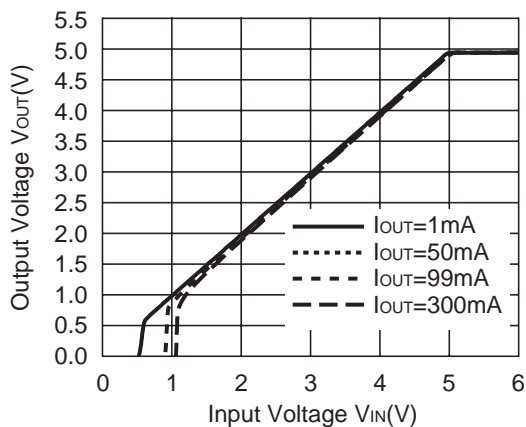

3) Dropout Voltage vs. Output Current ($T_{opt}=25^{\circ}\text{C}$)

R1173x081x

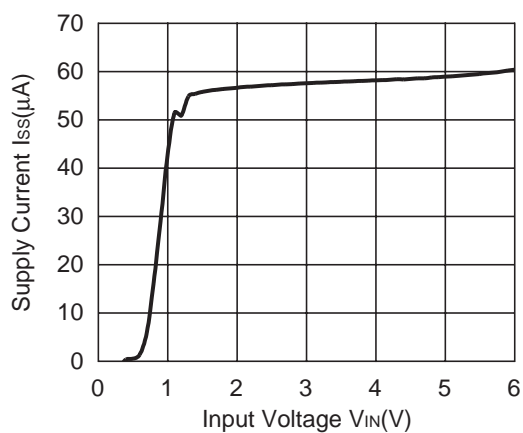

R1173x151x

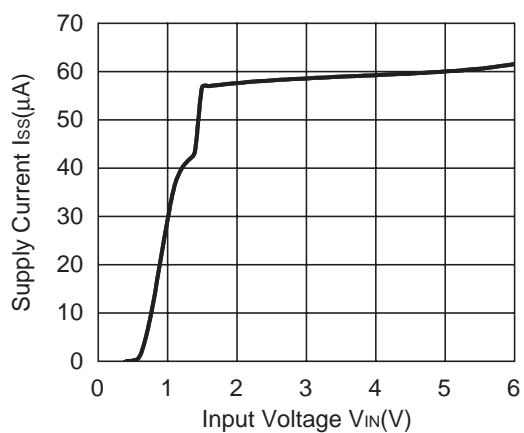

R1173x301x

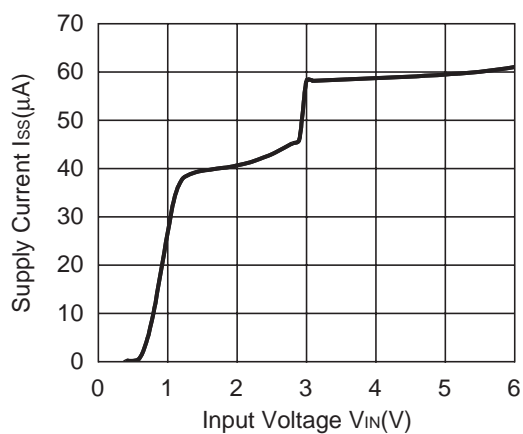

R1173x401x

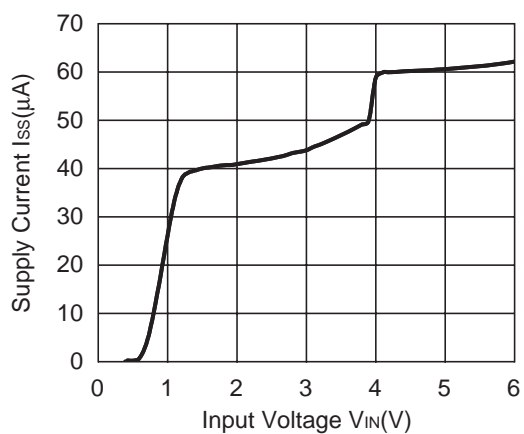

R1173x501x

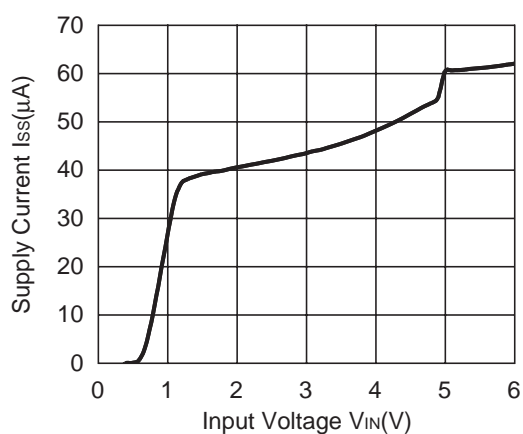

4) Output Voltage vs. Temperature ($I_{OUT}=100mA$)

R1173x081x

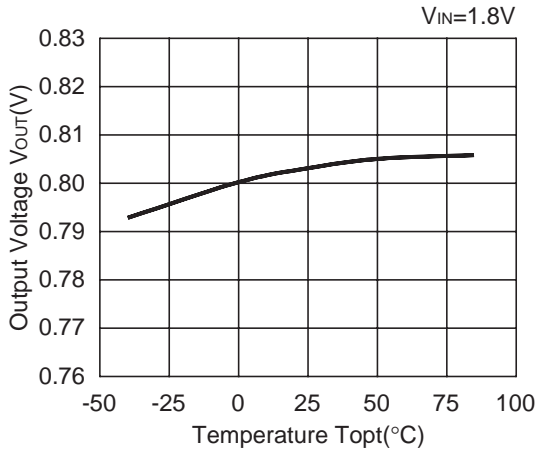

R1173x151x

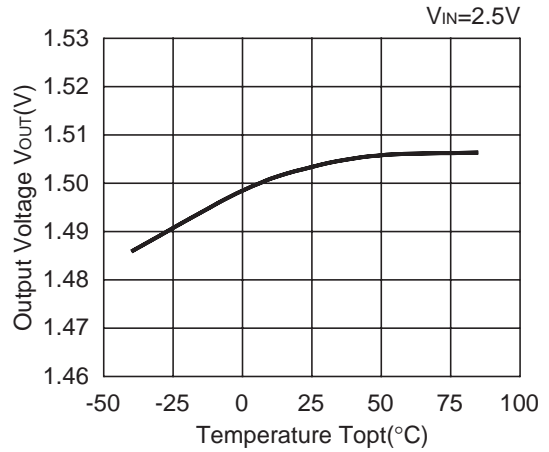

R1173x301x

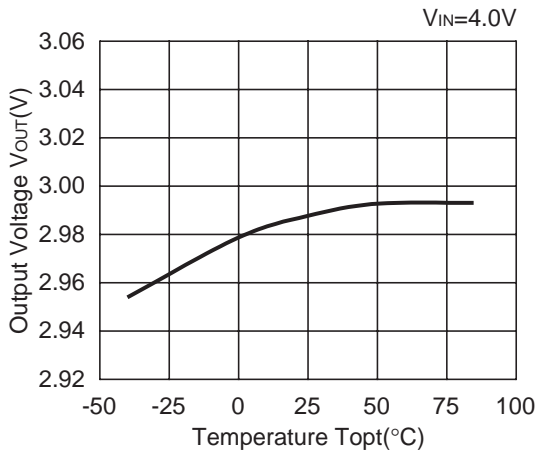

R1173x501x

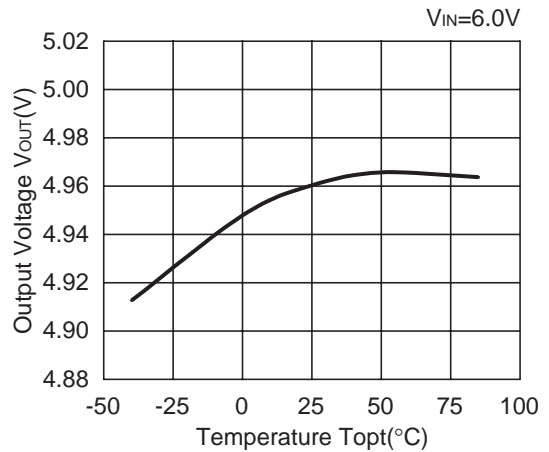

5) Supply Current vs. Temperature

R1173x081x

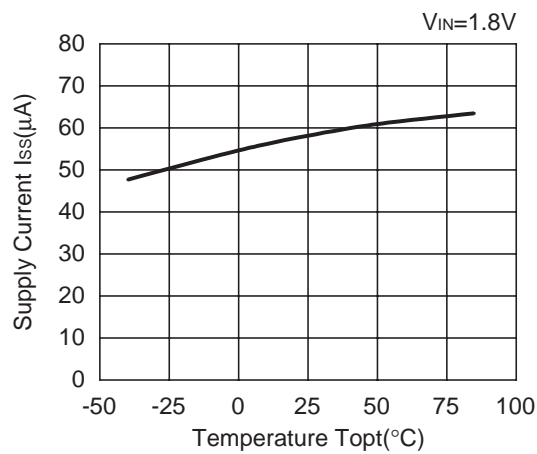

R1173x151x

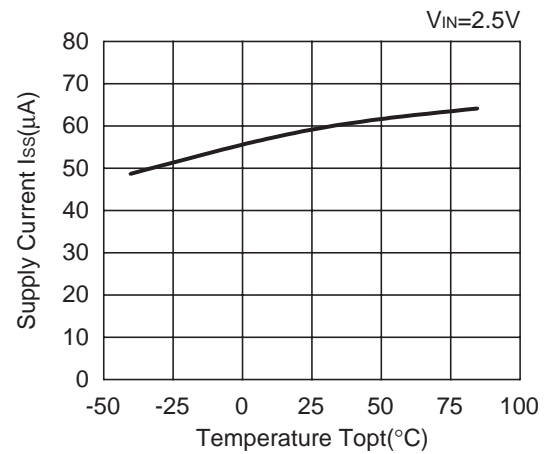

R1173x301x

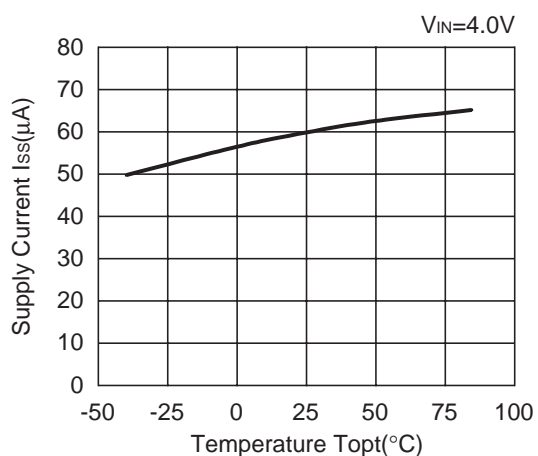

R1173x501x

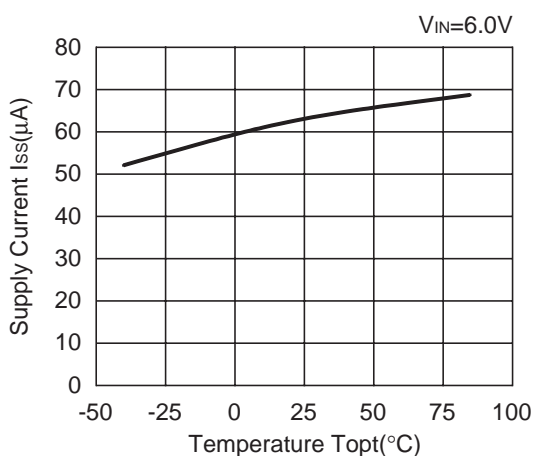

6) Dropout Voltage vs. Output Current

R1173x081x

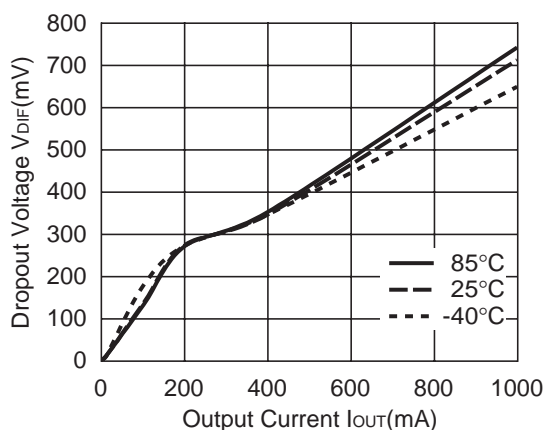

R1173x091x

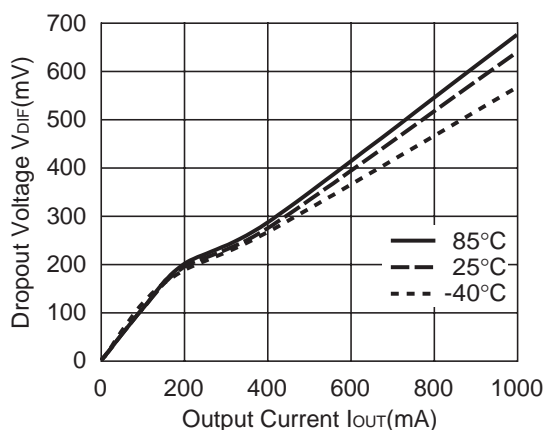

R1173x101x

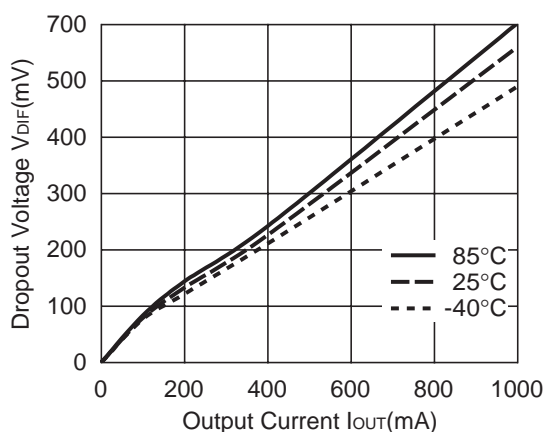

R1173x151x

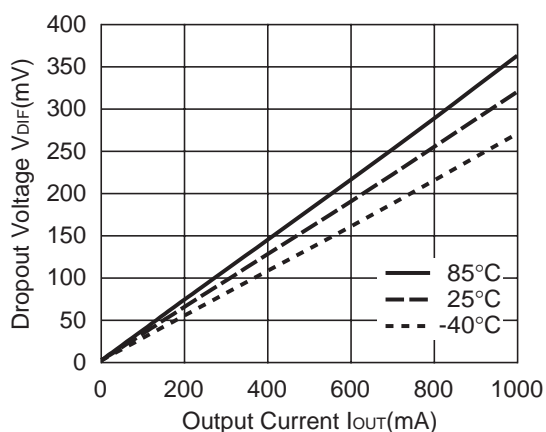

R1173x

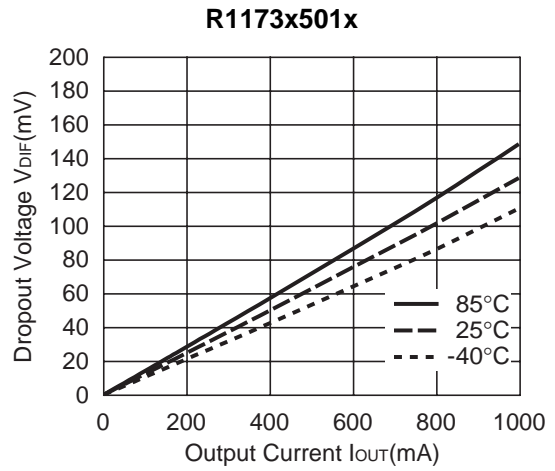
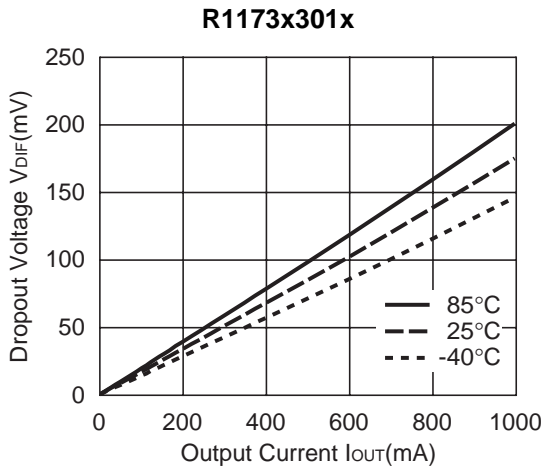

7) Dropout Voltage vs. Set Output Voltage

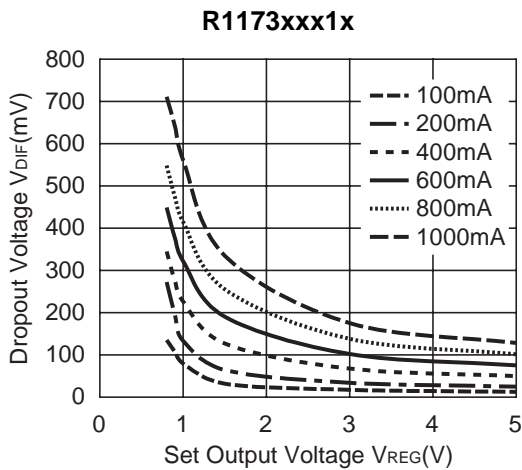

8) 0.8V Output type, Operating Input Voltage Range

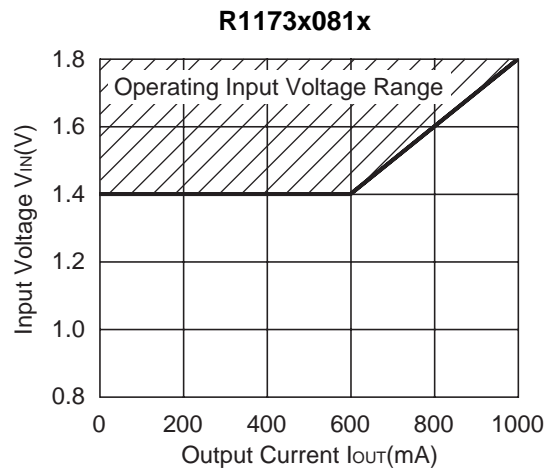

9) Ripple Rejection vs. Input Bias

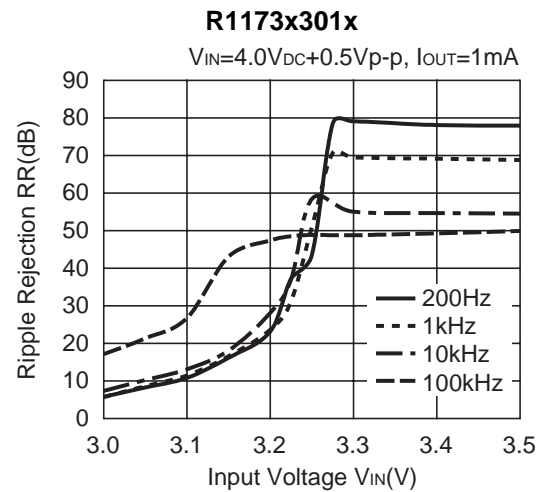
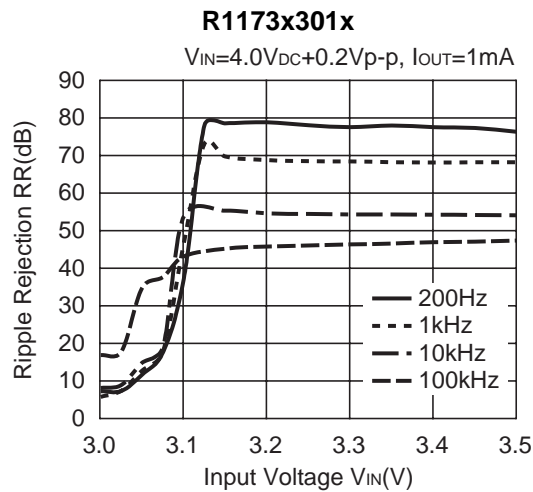

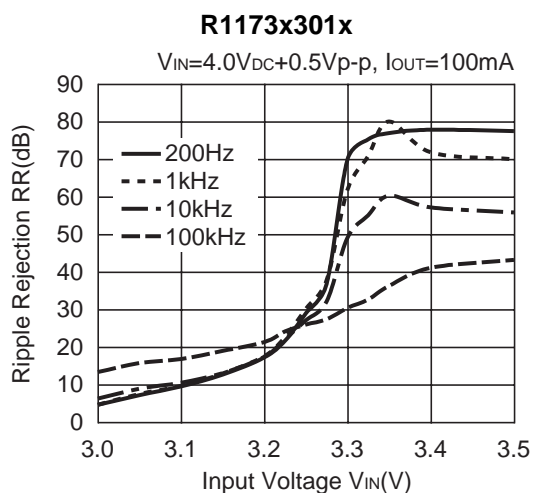
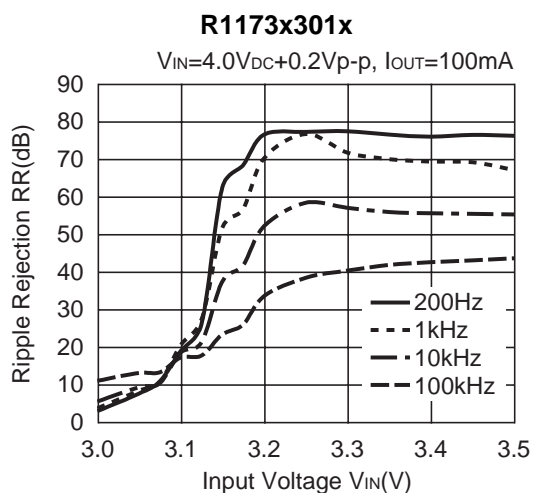
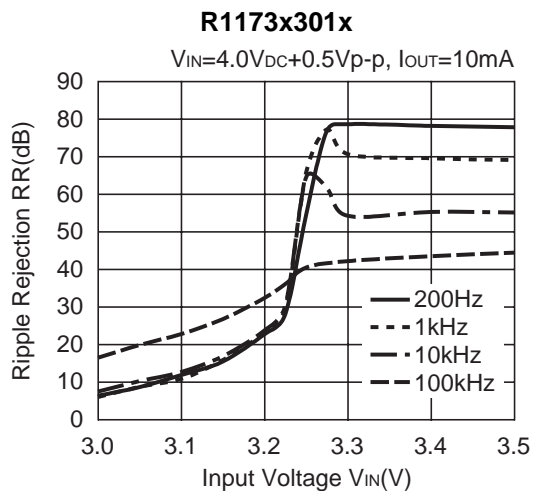
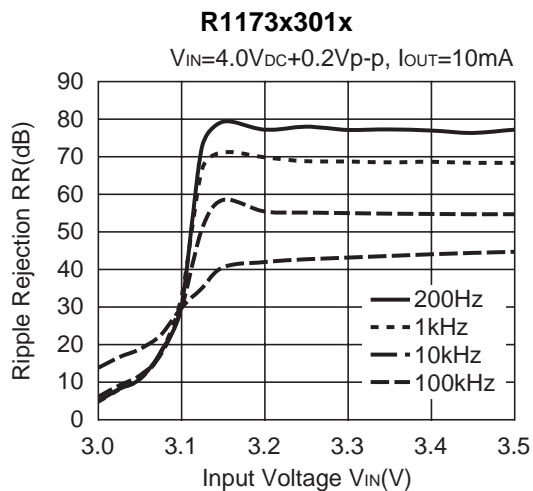

10) Ripple Rejection vs. Frequency

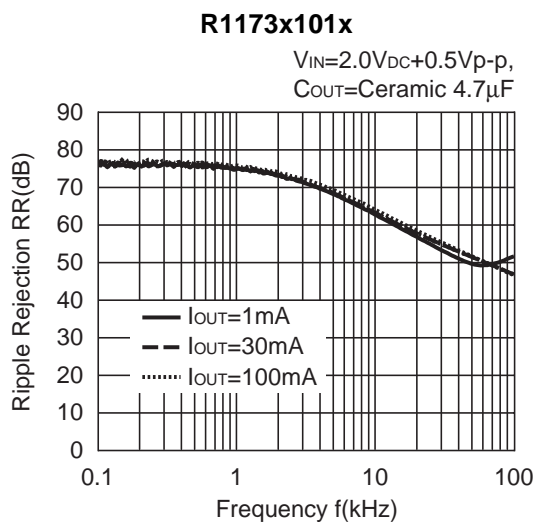
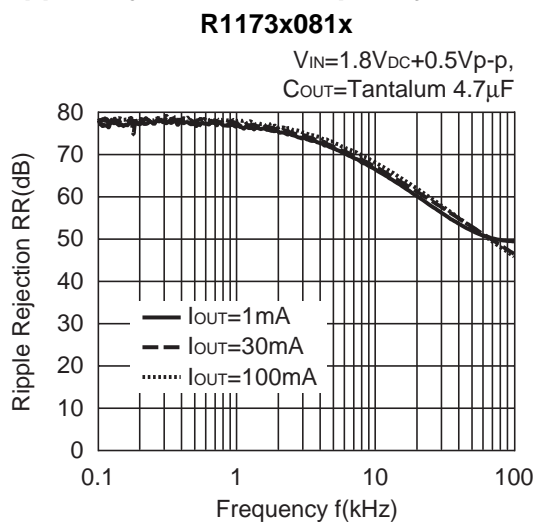

R1173x301x

$V_{IN}=4.0V_{DC}+0.5V_{p-p}$,
 $C_{OUT}=\text{Ceramic } 4.7\mu F$

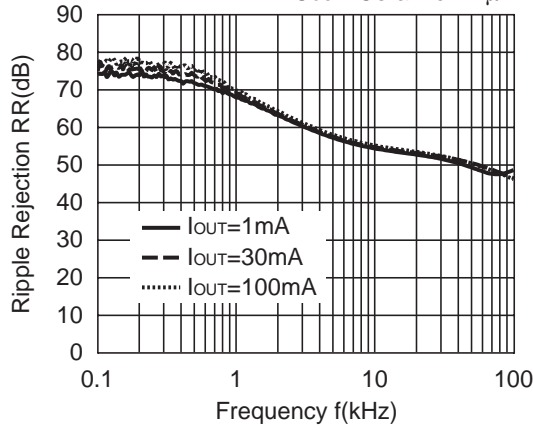

R1173x401x

$V_{IN}=5.0V_{DC}+0.5V_{p-p}$,
 $C_{OUT}=\text{Ceramic } 4.7\mu F$

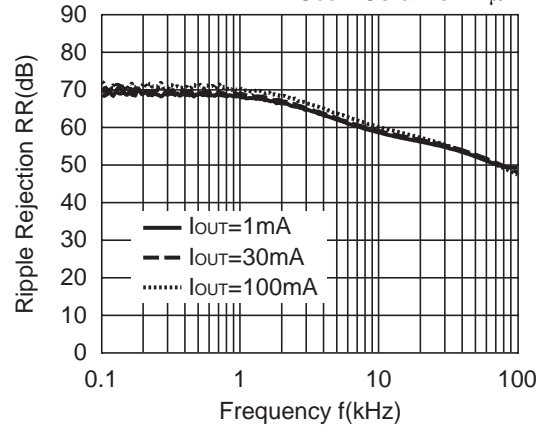

R1173x451x

$V_{IN}=5.5V_{DC}+0.5V_{p-p}$,
 $C_{OUT}=\text{Ceramic } 4.7\mu F$

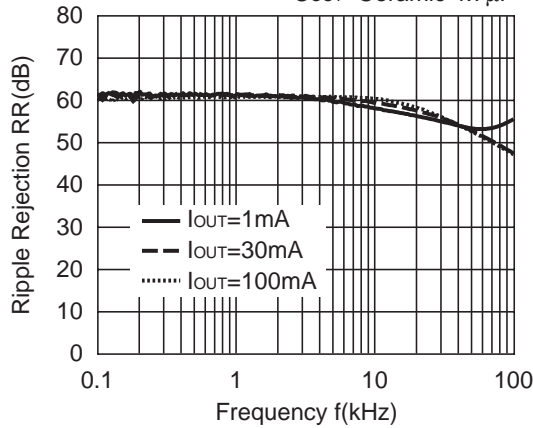

R1173x501x

$V_{IN}=6.0V_{DC}+0.5V_{p-p}$,
 $C_{OUT}=\text{Ceramic } 4.7\mu F$

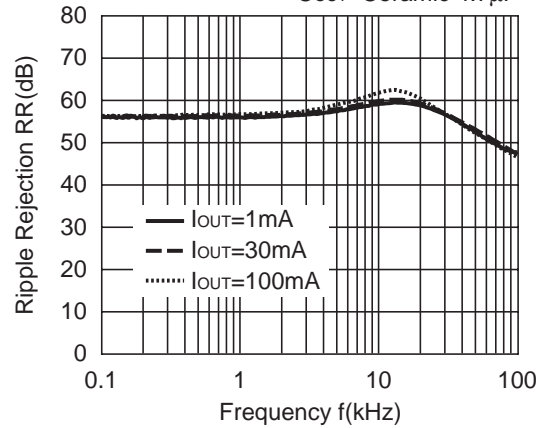

11) Line Transient Response ($T_r=T_f=5\mu s$, $I_{OUT}=100mA$)

R1173x081x

$C_{OUT}=\text{Tantalum } 4.7\mu F$

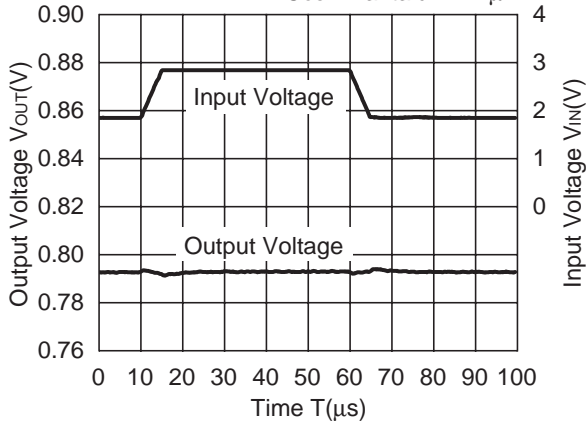

R1173x101x

$C_{OUT}=\text{Ceramic } 4.7\mu F$

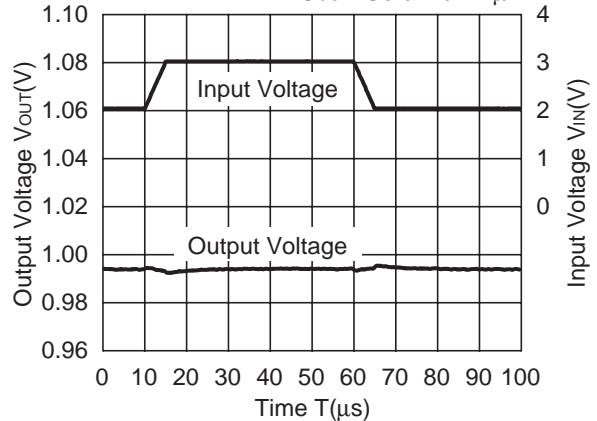

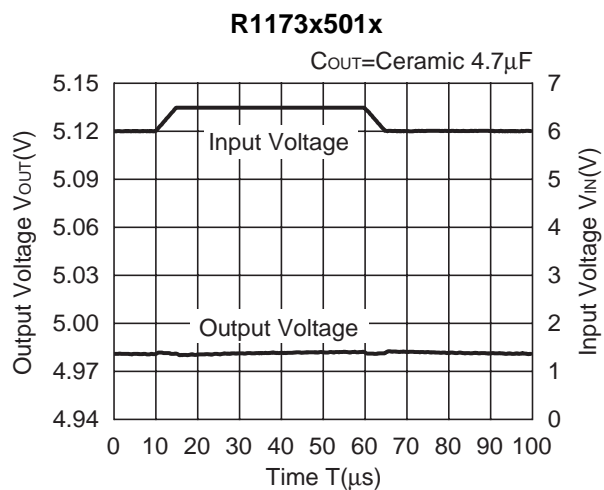
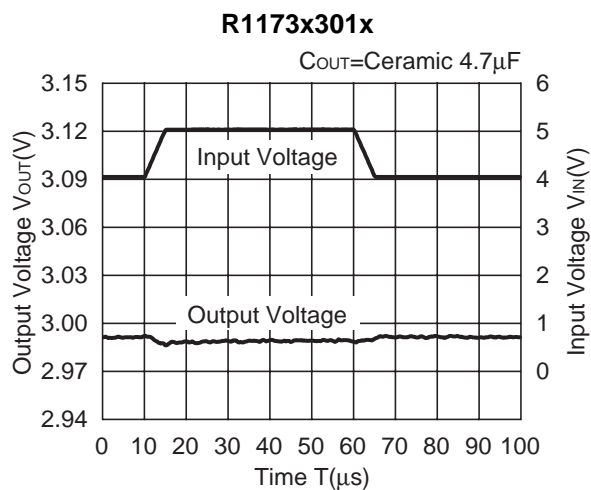

12) Load Transient Response (Tr=Tf=500ns)

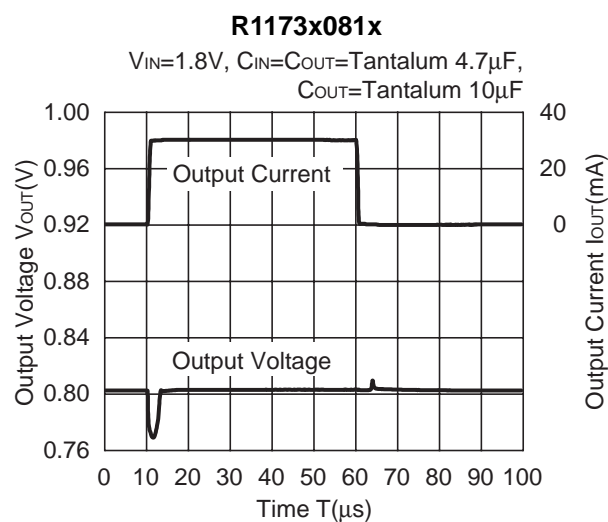
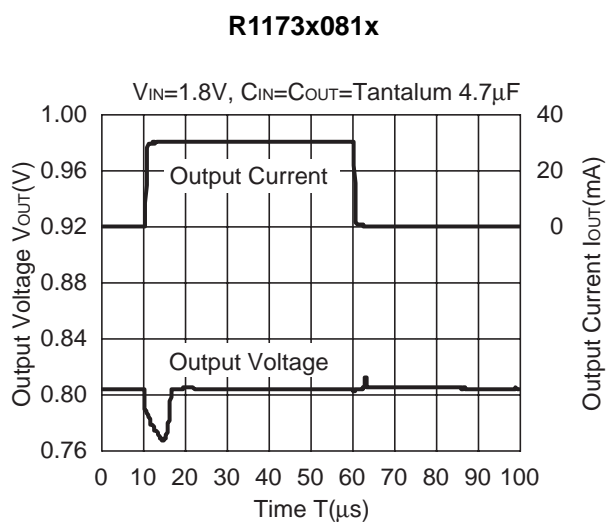
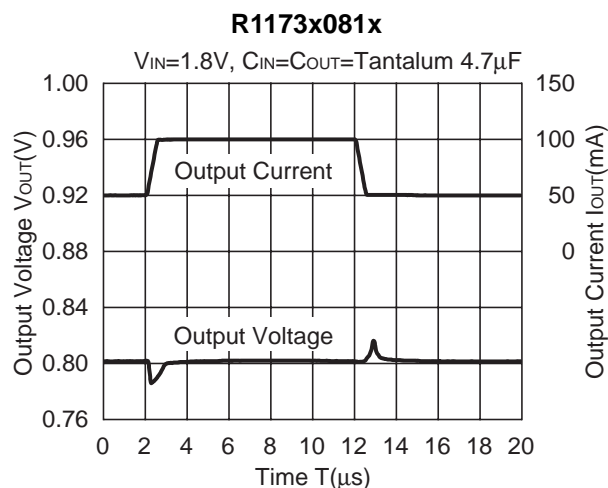
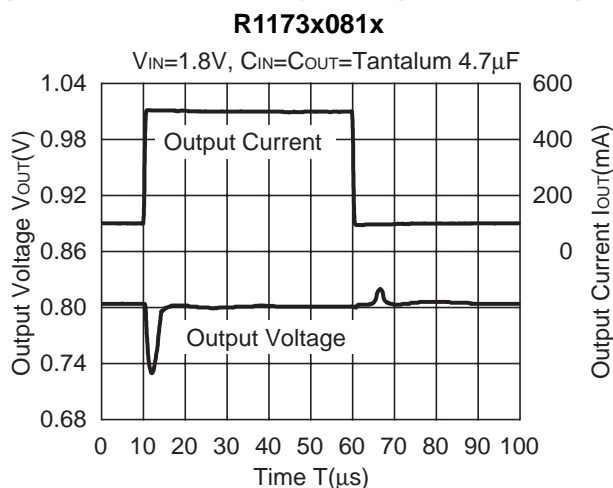

R1173x101x

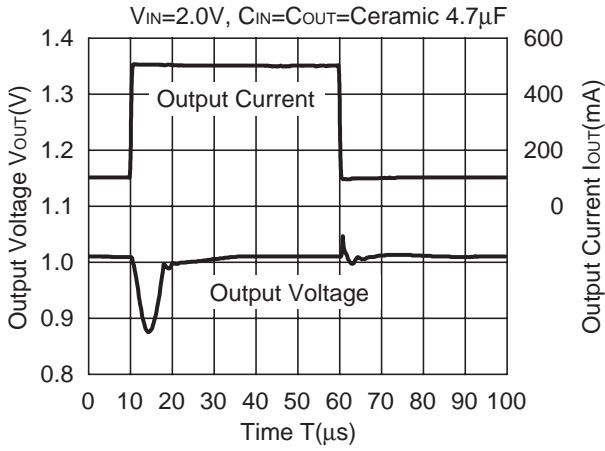

R1173x101x

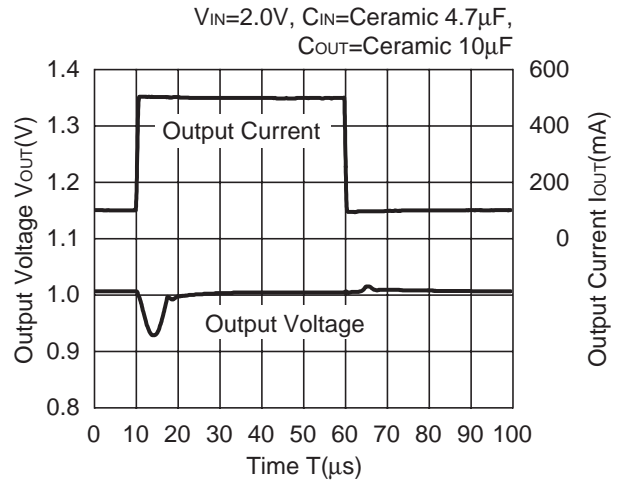

R1173x101x

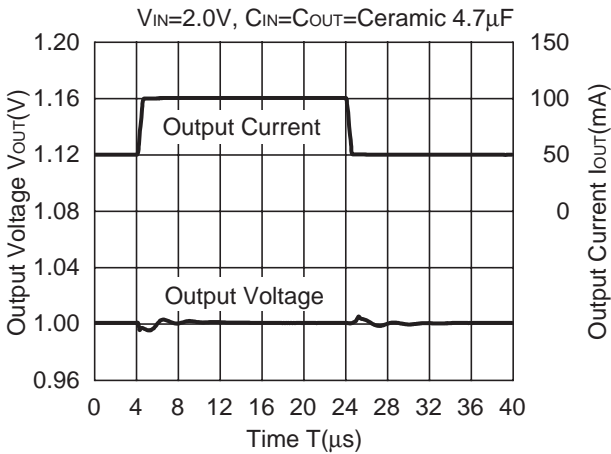

R1173x101x

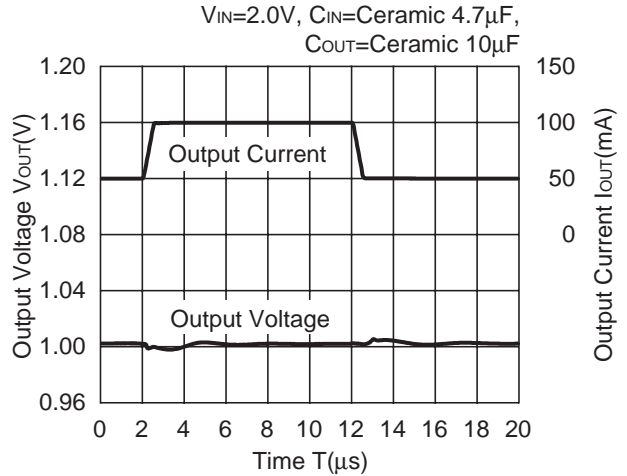

R1173x101x

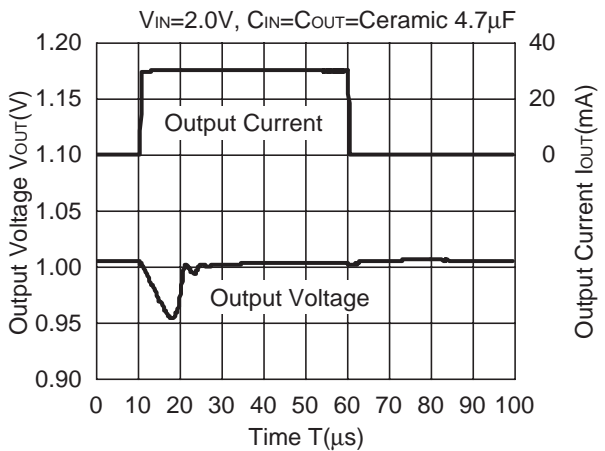

R1173x101x

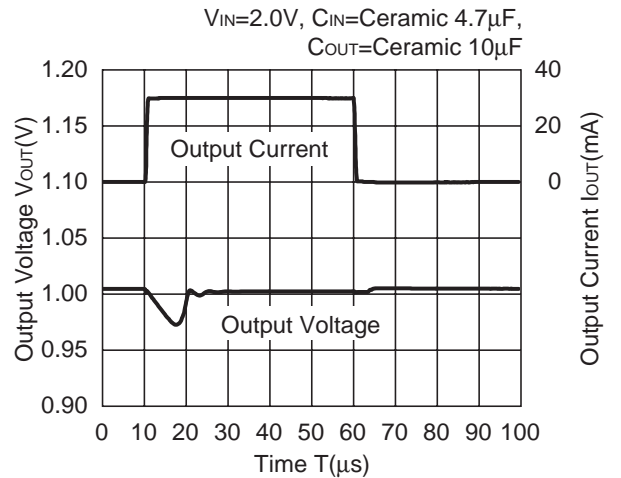

R1173x301x

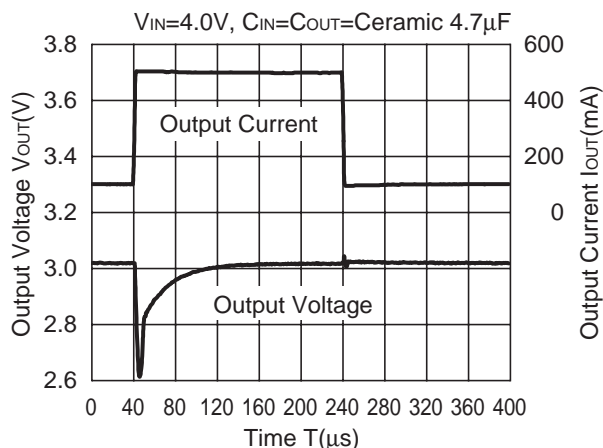

R1173x301x

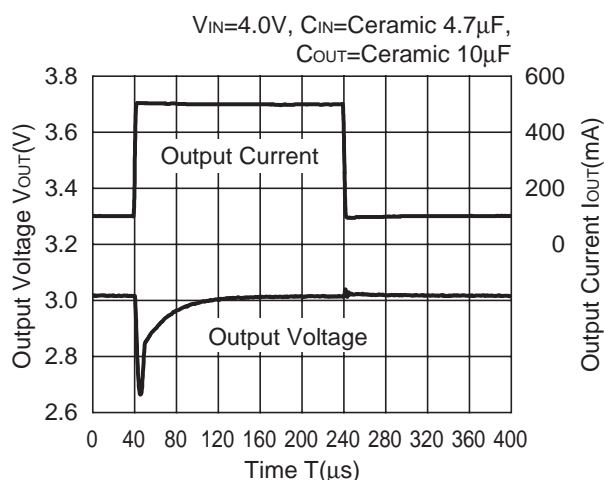

R1173x301x

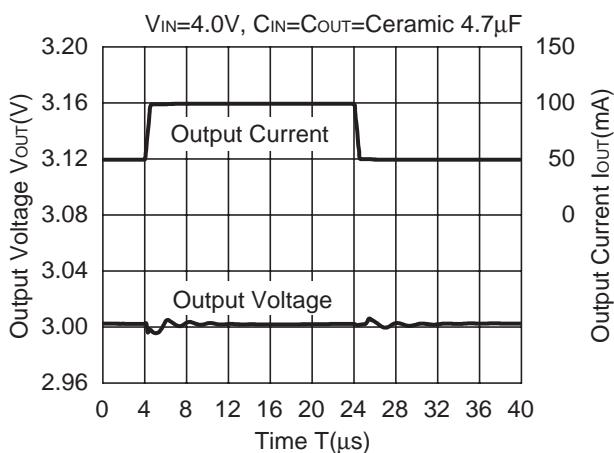

R1173x301x

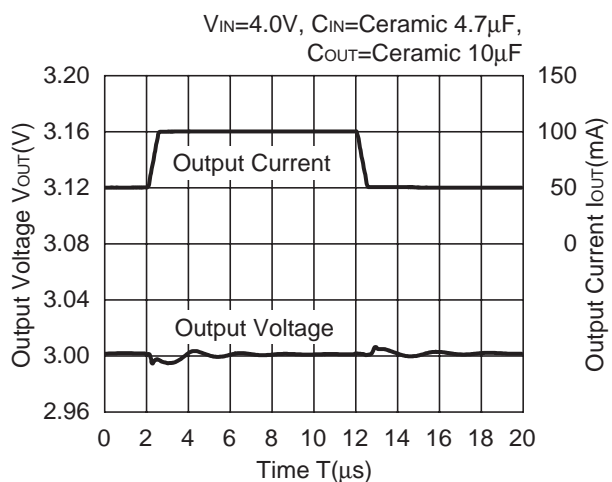

R1173x301x

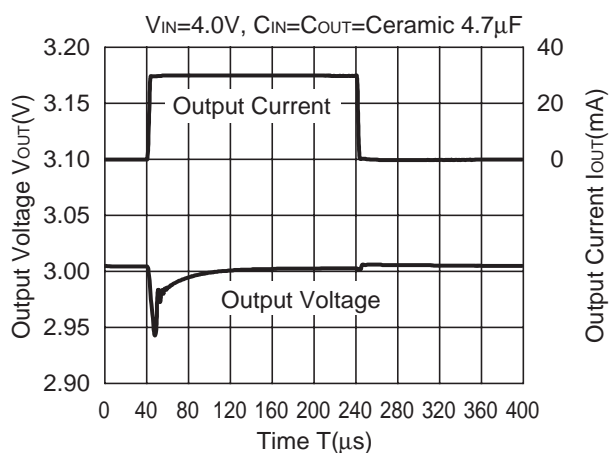

R1173x301x

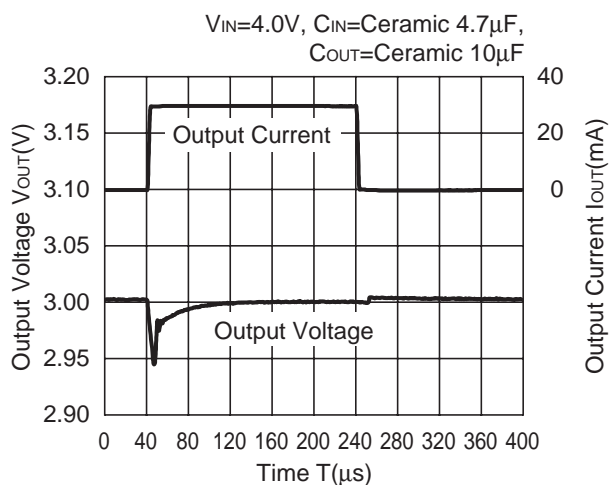

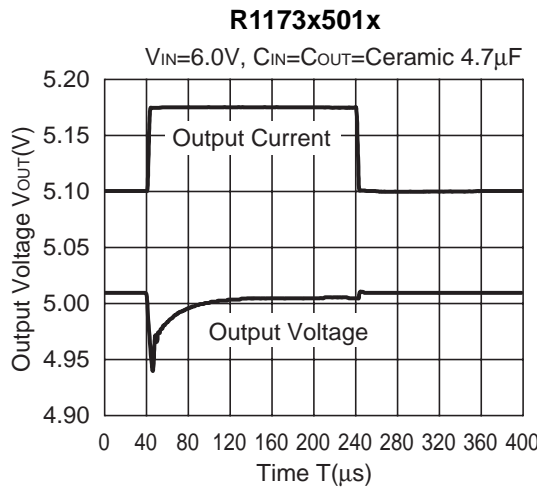
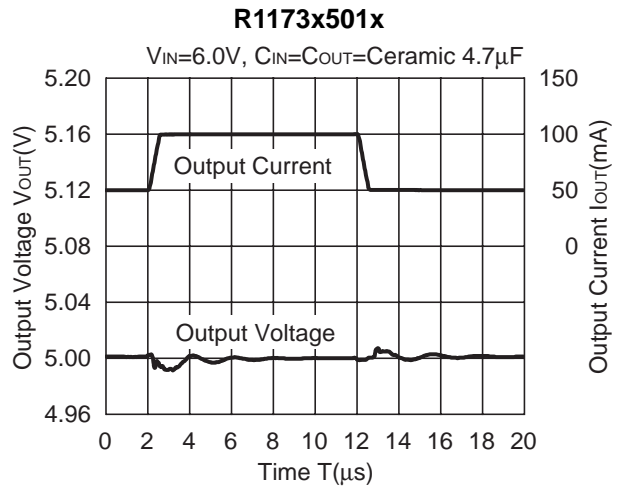
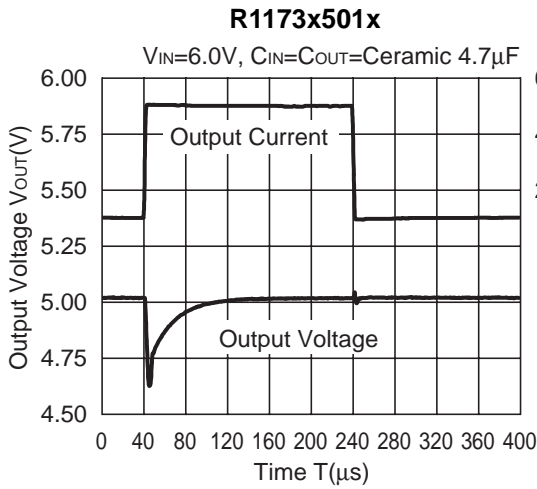

13) Turn-on speed with CE pin control

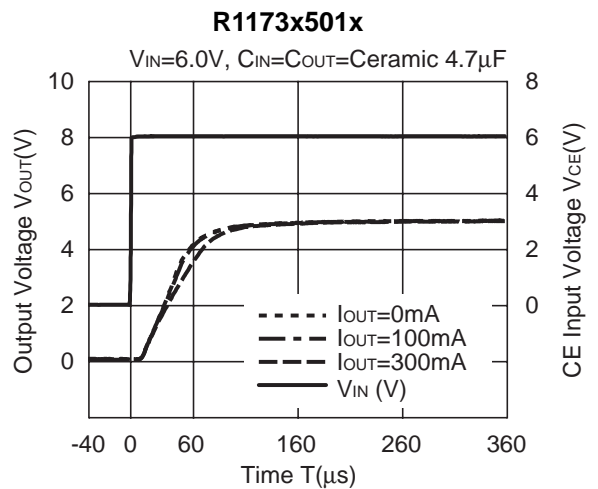
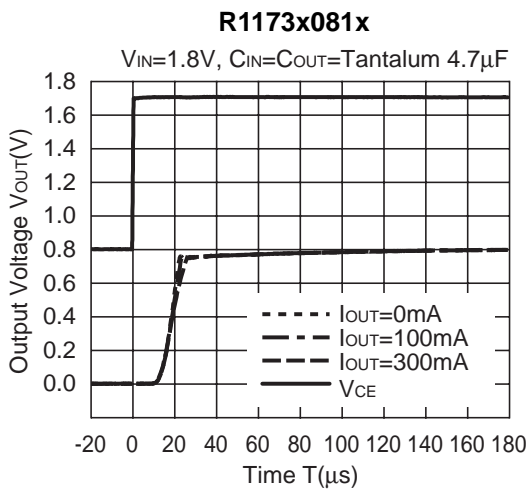

14) Turn-off speed with CE pin control

R1173x081D

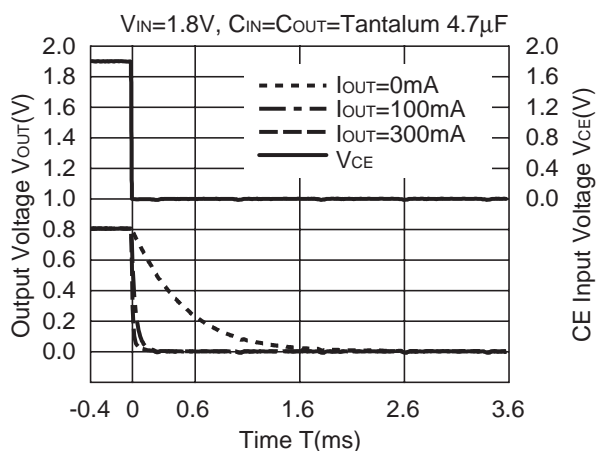

R1173x501D

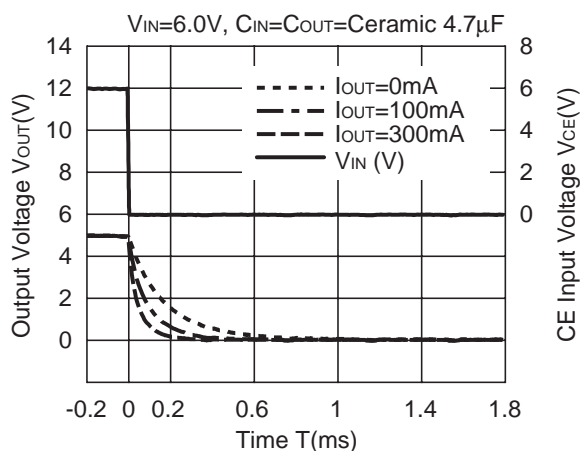

15) Inrush Current

R1173x081x

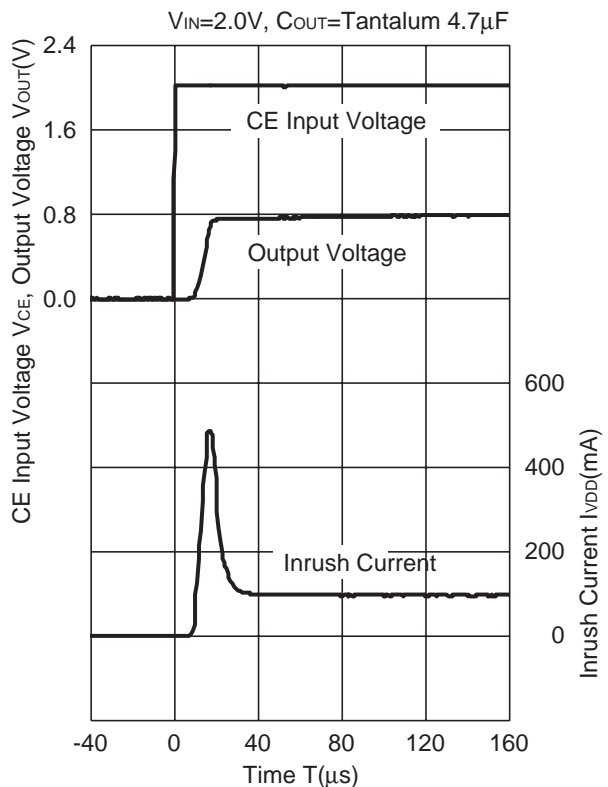

R1173x081x

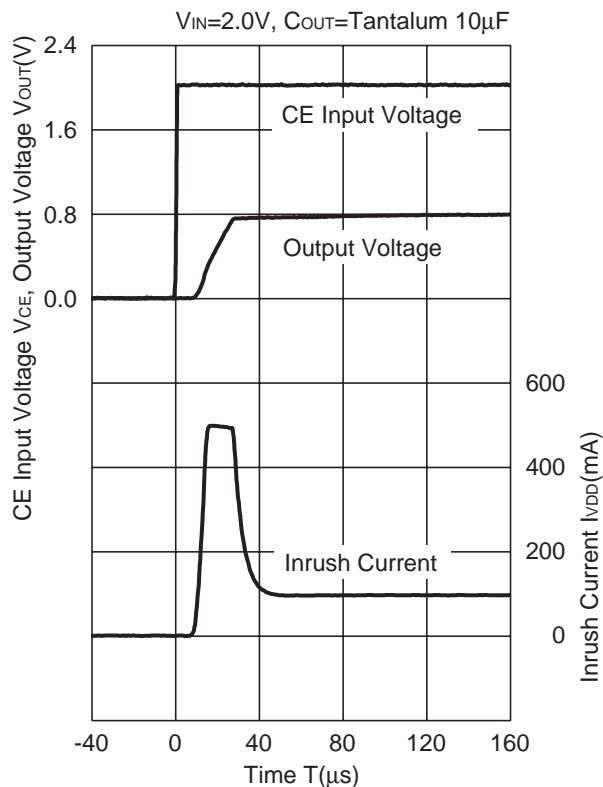

R1173x301x

V_{IN}=4.0V, C_{OUT}=Ceramic 4.7μF

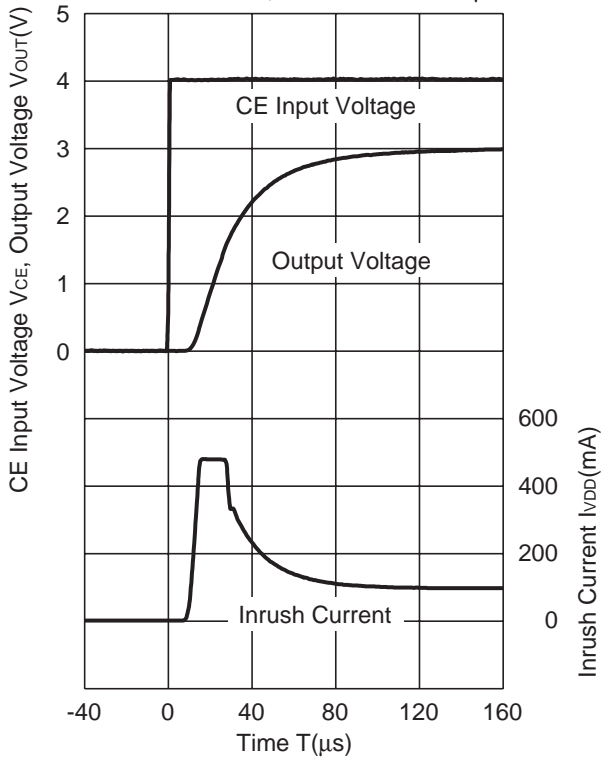

R1173x301x

V_{IN}=4.0V, C_{OUT}=Ceramic 10μF

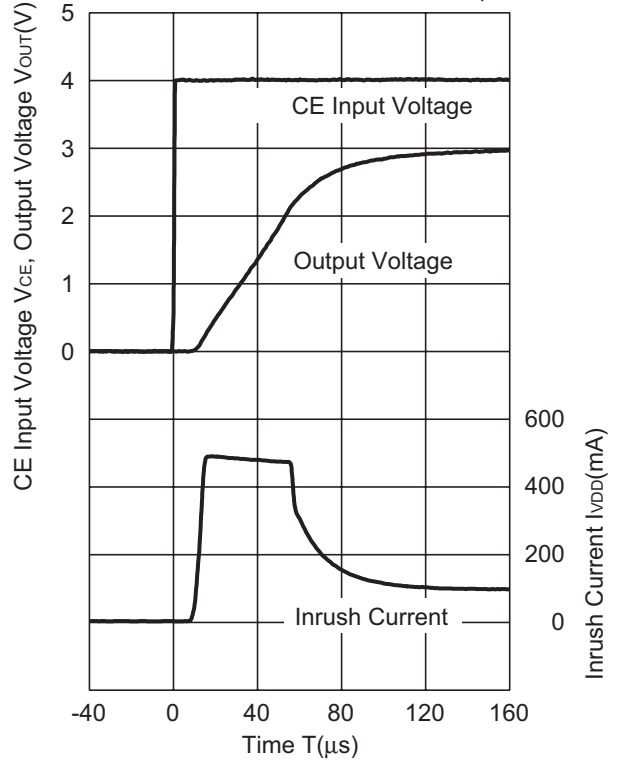

R1173x501x

V_{IN}=6.0V, C_{OUT}=Ceramic 4.7μF

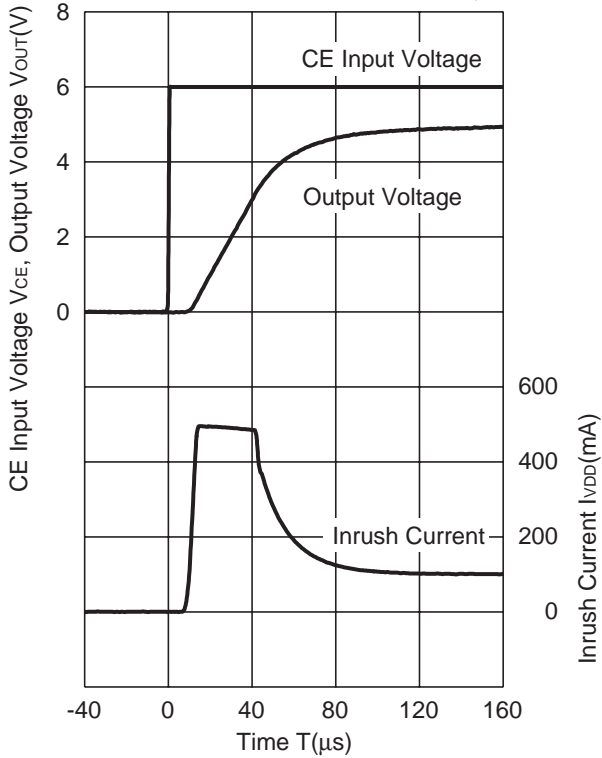

R1173x501x

V_{IN}=6.0V, C_{OUT}=Ceramic 10μF

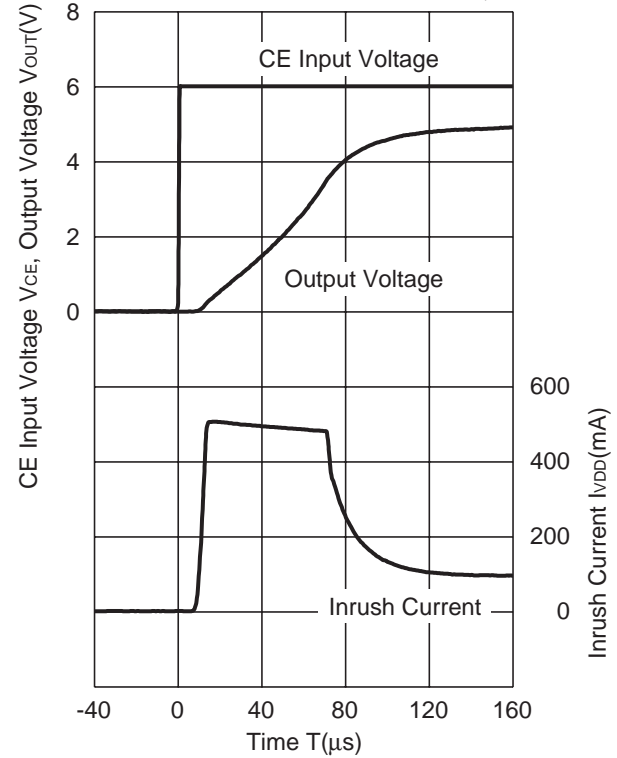

16) Stable Area: ESR limit vs. Load current

0.8V to 3.3V Output type : $C_{OUT}=4.7\mu F$ (Kyocera CM105X5R475M06AB)

5.0V Output type : $C_{OUT}=4.7\mu F$ (Kyocera CT21X5R475K06AB)

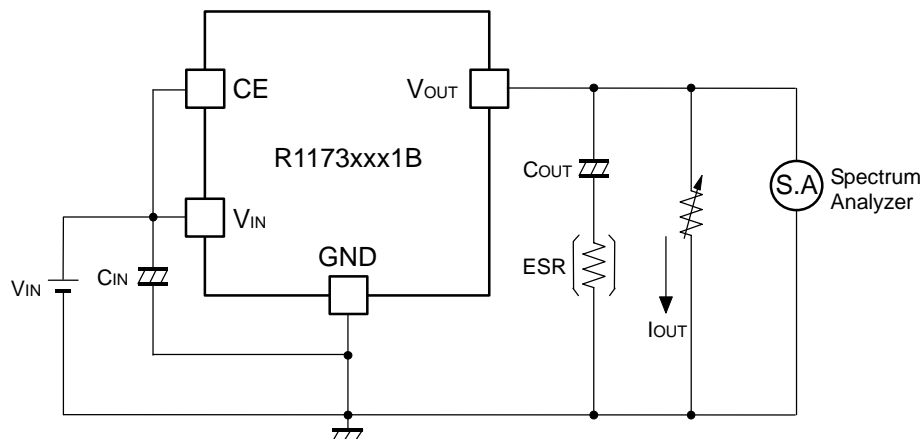

Measurement Conditions

- $V_{IN}=V_{OUT}+1V$
- Frequency=10Hz to 1MHz
- $T_{opt}=25^{\circ}C$

As an output capacitor for this IC, Ceramic capacitor is recommendable. However, other low ESR type capacitor can be used with this IC.

For your reference, noise level is tested, and if the noise level is $40\mu V$ or less than $40\mu V$, the ESR values are plotted as stable area. Upper limit is described in the next five graphs, or ESR vs. Output Current. (Hatched area is the stable area.)

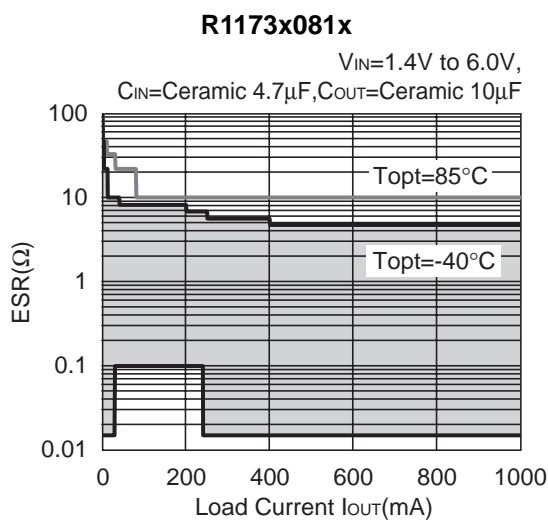
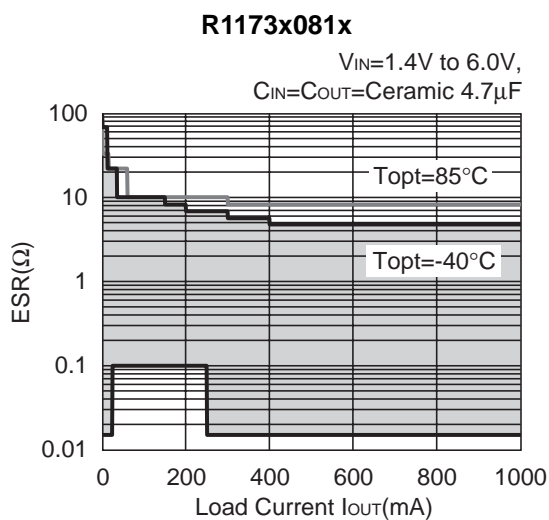

R1173x101x

$V_{IN}=1.4V$ to $6.0V$,
 $C_{IN}=C_{OUT}=\text{Ceramic } 4.7\mu F$

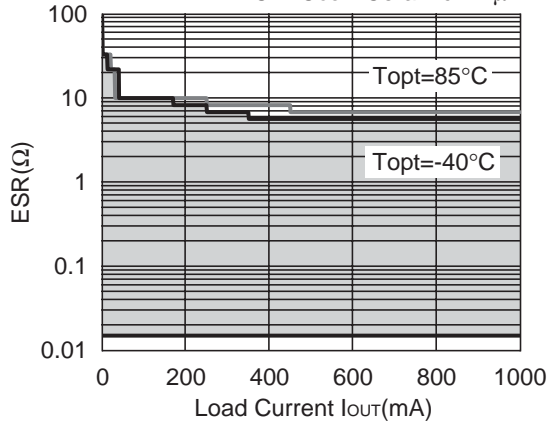

R1173x301x

$V_{IN}=3.1V$ to $6.0V$,
 $C_{IN}=C_{OUT}=\text{Ceramic } 4.7\mu F$

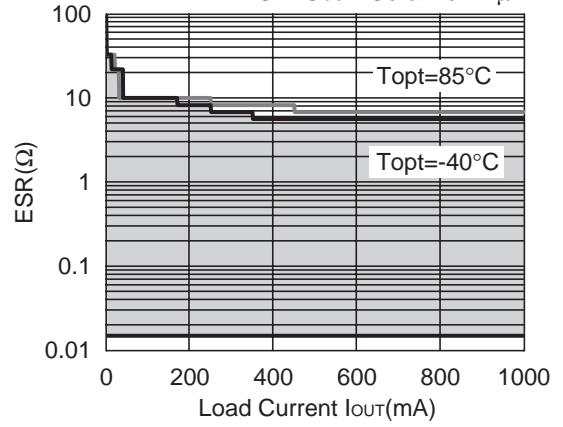

R1173x501x

$V_{IN}=3.1V$ to $6.0V$,
 $C_{IN}=C_{OUT}=\text{Ceramic } 4.7\mu F$

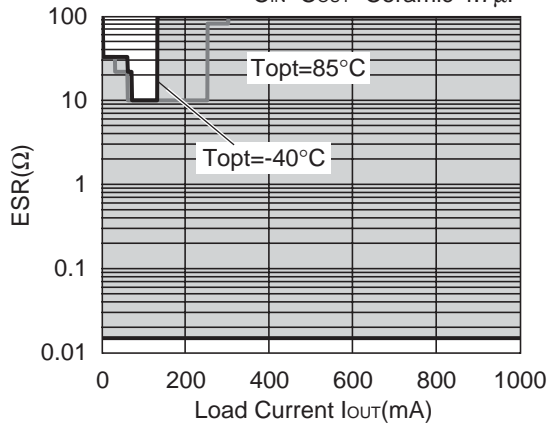

POWER DISSIPATION (SOT-89-5)

This specification is at mounted on board. Power Dissipation (P_D) depends on conditions of mounting on board. This specification is based on the measurement at the condition below:

Measurement Conditions

| | High Wattage Land Pattern | Standard Land Pattern |
|------------------|--|--|
| Environment | Mounting on Board (Wind velocity=0m/s) | Mounting on Board (Wind velocity=0m/s) |
| Board Material | Glass cloth epoxy plastic (Double sided) | Glass cloth epoxy plastic (Double sided) |
| Board Dimensions | 30mm × 30mm × 1.6mm | 50mm × 50mm × 1.6mm |
| Copper Ratio | Top side : Approx. 20% , Back side : Approx. 100% | Top side : Approx. 10% , Back side : Approx. 100% |
| Through-hole | φ0.85mm × 10pcs | - |

Measurement Result

($T_{opt}=25^{\circ}C, T_{jmax}=125^{\circ}C$)

| | High Wattage Land Pattern | Standard Land Pattern | Free Air |
|--------------------|---------------------------|-----------------------|----------|
| Power Dissipation | 1300mW | 900mW | 500mW |
| Thermal Resistance | 77°C/W | 111°C/W | 200°C/W |

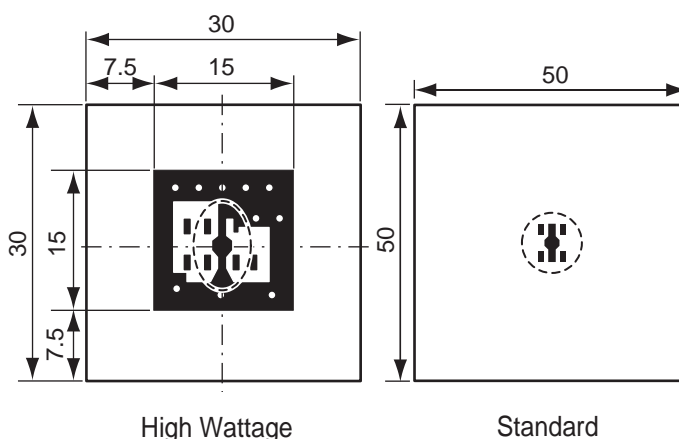
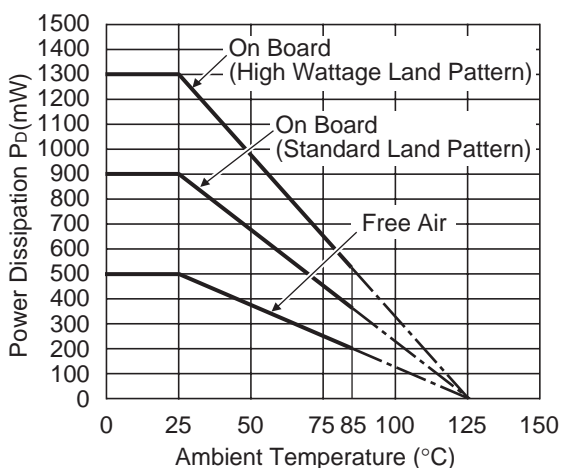

Measurement Board Pattern

○ IC Mount Area (Unit : mm)

RECOMMENDED LAND PATTERN (SOT-89-5)

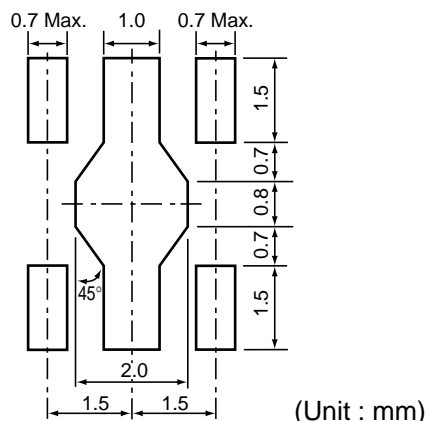

• HSON-6

Unit: mm

PACKAGE DIMENSIONS

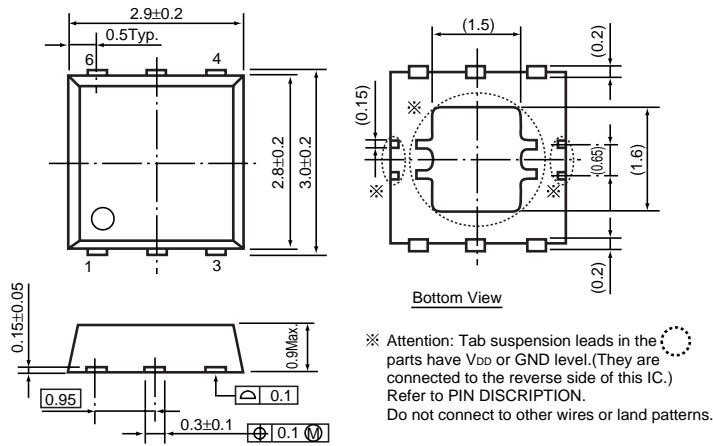

TAPING SPECIFICATION

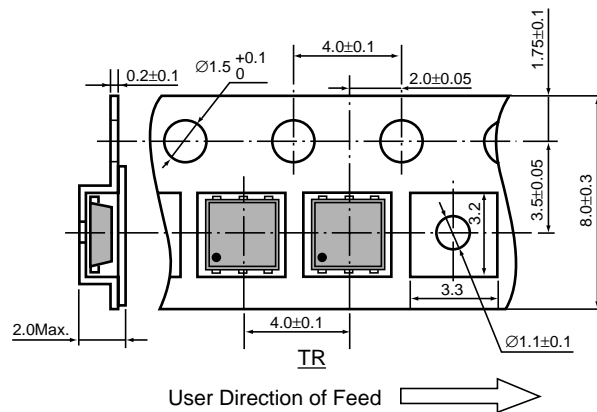

TAPING REEL DIMENSIONS REUSE REEL (EIAJ-RRM-08Bc)

(1reel=3000pcs)

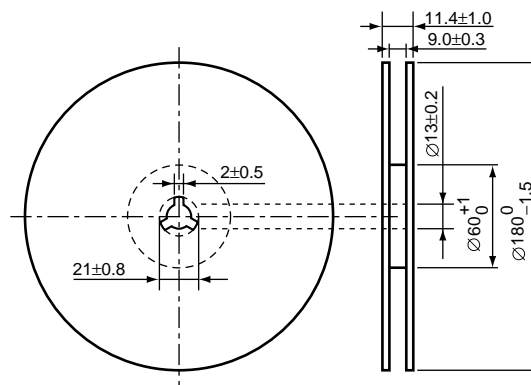

POWER DISSIPATION (HSON-6)

This specification is at mounted on board. Power Dissipation (P_D) depends on conditions of mounting on board. This specification is based on the measurement at the condition below:

Measurement Conditions

| | |
|------------------|--|
| | Standard Land Pattern |
| Environment | Mounting on Board (Wind velocity=0m/s) |
| Board Material | Glass cloth epoxy plactic (Double sided) |
| Board Dimensions | 40mm × 40mm × 1.6mm |
| Copper Ratio | Top side : Approx. 50% , Back side : Approx. 50% |
| Through-hole | φ0.5mm × 44pcs |

Measurement Result

($T_{opt}=25^{\circ}\text{C}$, $T_{jmax}=125^{\circ}\text{C}$)

| | | |
|--------------------|--|----------|
| | Standard Land Pattern | Free Air |
| Power Dissipation | 900mW | 400mW |
| Thermal Resistance | $\theta_{ja}=(125-25^{\circ}\text{C})/0.9\text{W}=111^{\circ}\text{C/W}$ | 250°C/W |

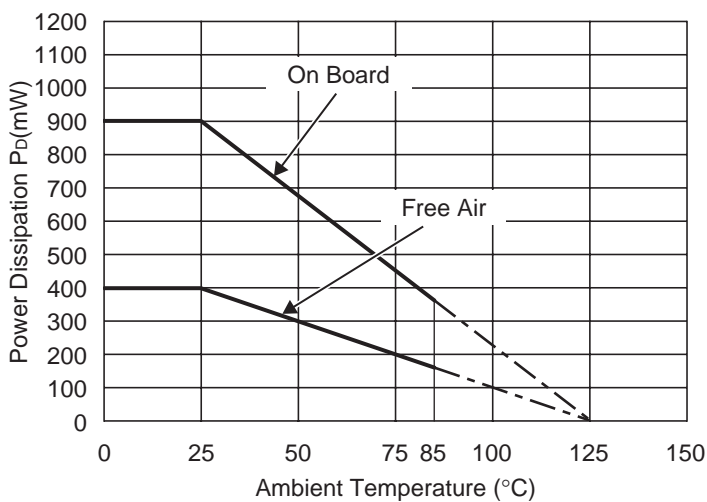

Power Dissipation

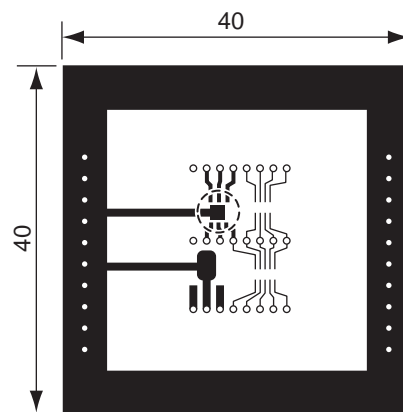

Measurement Board Pattern

○ IC Mount Area Unit : mm

RECOMMENDED LAND PATTERN

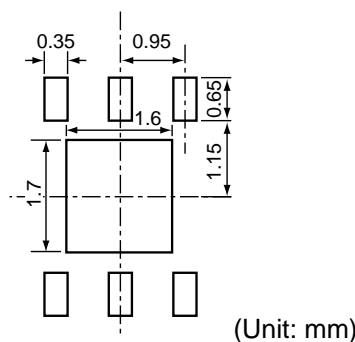

• HSOP-6J

Unit: mm

PACKAGE DIMENSIONS

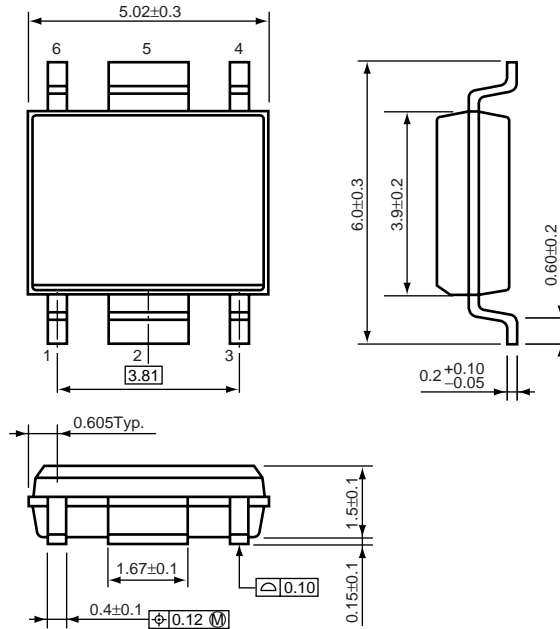

TAPING SPECIFICATION

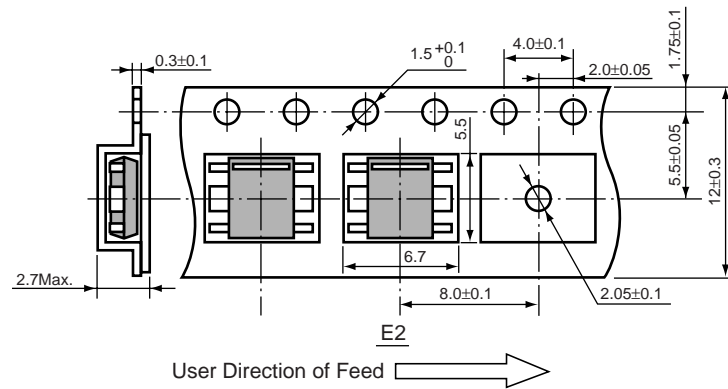

TAPING REEL DIMENSIONS REUSE REEL (EIAJ-RRM-12Bc)

(1reel=1000pcs)

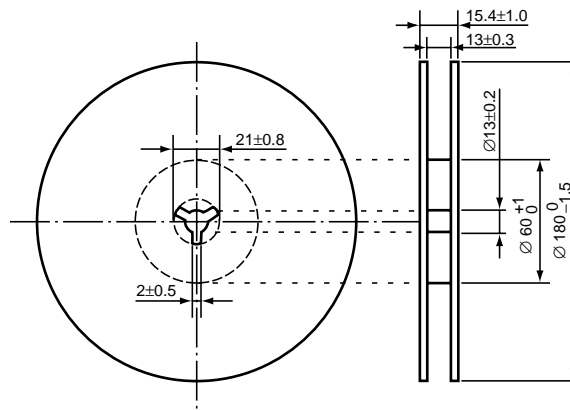

POWER DISSIPATION (HSOP-6J)

This specification is at mounted on board. Power Dissipation (P_D) depends on conditions of mounting on board. This specification is based on the measurement at the condition below:

Measurement Conditions

| | High Wattage Land Pattern | Standard Land Pattern |
|------------------|--|--|
| Environment | Mounting on Board (Wind velocity=0m/s) | Mounting on Board (Wind velocity=0m/s) |
| Board Material | Glass cloth epoxy plactic (Double sided) | Glass cloth epoxy plactic (Double sided) |
| Board Dimensions | 50mm × 50mm × 1.6mm | 50mm × 50mm × 1.6mm |
| Copper Ratio | 90% | 50% |
| Through-hole | φ0.5mm × 44pcs | φ0.5mm × 44pcs |

Measurement Result

($T_{opt}=25^{\circ}C, T_{jmax}=125^{\circ}C$)

| | High Wattage Land Pattern | Standard Land Pattern | Free Air |
|--------------------|---------------------------|-----------------------|----------|
| Power Dissipation | 2000mW | 1700mW | 540mW |
| Thermal Resistance | 50°C/W | 59°C/W | 185°C/W |

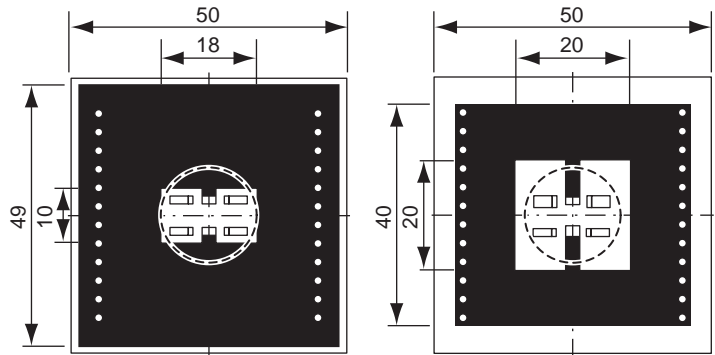
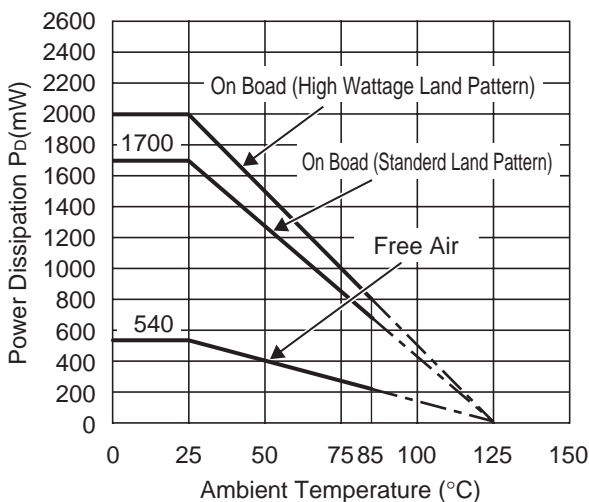

High Wattage Standard

Measurement Board Pattern

○ IC Mount Area Unit : mm

RECOMMENDED LAND PATTERN (HSOP-6J)

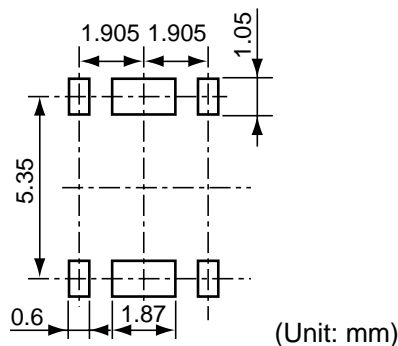

R1173H SERIES MARK SPECIFICATION

● SOT-89-5

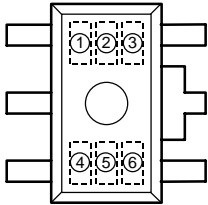

- ① : L (fixed)
- ②, ③ : Setting Voltage } (refer to Part Number vs. Product Code)
- ④ : Type (B,D)
- ⑤, ⑥ : Lot Number

● Part Number vs. Product Code

| Part Number | Product Code | | | |
|-------------|--------------|---|---|---|
| | ① | ② | ③ | ④ |
| R1173H081B | L | 0 | 8 | B |
| R1173H091B | L | 0 | 9 | B |
| R1173H101B | L | 1 | 0 | B |
| R1173H111B | L | 1 | 1 | B |
| R1173H121B | L | 1 | 2 | B |
| R1173H131B | L | 1 | 3 | B |
| R1173H141B | L | 1 | 4 | B |
| R1173H151B | L | 1 | 5 | B |
| R1173H161B | L | 1 | 6 | B |
| R1173H171B | L | 1 | 7 | B |
| R1173H181B | L | 1 | 8 | B |
| R1173H191B | L | 1 | 9 | B |
| R1173H201B | L | 2 | 0 | B |
| R1173H211B | L | 2 | 1 | B |
| R1173H221B | L | 2 | 2 | B |
| R1173H231B | L | 2 | 3 | B |
| R1173H241B | L | 2 | 4 | B |
| R1173H251B | L | 2 | 5 | B |
| R1173H261B | L | 2 | 6 | B |
| R1173H271B | L | 2 | 7 | B |
| R1173H281B | L | 2 | 8 | B |
| R1173H291B | L | 2 | 9 | B |
| R1173H301B | L | 3 | 0 | B |

| Part Number | Product Code | | | |
|-------------|--------------|---|---|---|
| | ① | ② | ③ | ④ |
| R1173H311B | L | 3 | 1 | B |
| R1173H321B | L | 3 | 2 | B |
| R1173H331B | L | 3 | 3 | B |
| R1173H341B | L | 3 | 4 | B |
| R1173H351B | L | 3 | 5 | B |
| R1173H361B | L | 3 | 6 | B |
| R1173H371B | L | 3 | 7 | B |
| R1173H381B | L | 3 | 8 | B |
| R1173H391B | L | 3 | 9 | B |
| R1173H401B | L | 4 | 0 | B |
| R1173H411B | L | 4 | 1 | B |
| R1173H421B | L | 4 | 2 | B |
| R1173H431B | L | 4 | 3 | B |
| R1173H441B | L | 4 | 4 | B |
| R1173H451B | L | 4 | 5 | B |
| R1173H461B | L | 4 | 6 | B |
| R1173H471B | L | 4 | 7 | B |
| R1173H481B | L | 4 | 8 | B |
| R1173H491B | L | 4 | 9 | B |
| R1173H501B | L | 5 | 0 | B |
| R1173H181B5 | L | 0 | 1 | B |
| R1173H281B5 | L | 0 | 2 | B |
| R1173H001B | L | 0 | 0 | B |

| Part Number | Product Code | | | |
|-------------|--------------|---|---|---|
| | ① | ② | ③ | ④ |
| R1173H081D | L | 0 | 8 | D |
| R1173H091D | L | 0 | 9 | D |
| R1173H101D | L | 1 | 0 | D |
| R1173H111D | L | 1 | 1 | D |
| R1173H121D | L | 1 | 2 | D |
| R1173H131D | L | 1 | 3 | D |
| R1173H141D | L | 1 | 4 | D |
| R1173H151D | L | 1 | 5 | D |
| R1173H161D | L | 1 | 6 | D |
| R1173H171D | L | 1 | 7 | D |
| R1173H181D | L | 1 | 8 | D |
| R1173H191D | L | 1 | 9 | D |
| R1173H201D | L | 2 | 0 | D |
| R1173H211D | L | 2 | 1 | D |
| R1173H221D | L | 2 | 2 | D |
| R1173H231D | L | 2 | 3 | D |
| R1173H241D | L | 2 | 4 | D |
| R1173H251D | L | 2 | 5 | D |
| R1173H261D | L | 2 | 6 | D |
| R1173H271D | L | 2 | 7 | D |
| R1173H281D | L | 2 | 8 | D |
| R1173H291D | L | 2 | 9 | D |
| R1173H301D | L | 3 | 0 | D |

| Part Number | Product Code | | | |
|-------------|--------------|---|---|---|
| | ① | ② | ③ | ④ |
| R1173H311D | L | 3 | 1 | D |
| R1173H321D | L | 3 | 2 | D |
| R1173H331D | L | 3 | 3 | D |
| R1173H341D | L | 3 | 4 | D |
| R1173H351D | L | 3 | 5 | D |
| R1173H361D | L | 3 | 6 | D |
| R1173H371D | L | 3 | 7 | D |
| R1173H381D | L | 3 | 8 | D |
| R1173H391D | L | 3 | 9 | D |
| R1173H401D | L | 4 | 0 | D |
| R1173H411D | L | 4 | 1 | D |
| R1173H421D | L | 4 | 2 | D |
| R1173H431D | L | 4 | 3 | D |
| R1173H441D | L | 4 | 4 | D |
| R1173H451D | L | 4 | 5 | D |
| R1173H461D | L | 4 | 6 | D |
| R1173H471D | L | 4 | 7 | D |
| R1173H481D | L | 4 | 8 | D |
| R1173H491D | L | 4 | 9 | D |
| R1173H501D | L | 5 | 0 | D |
| R1173H181D5 | L | 0 | 1 | D |
| R1173H281D5 | L | 0 | 2 | D |
| R1173H001D | L | 0 | 0 | D |

R1173D SERIES MARK SPECIFICATION

• HSON-6

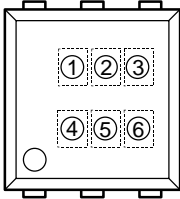

- ① : H (fixed)
- ②, ③ : Setting Voltage } (refer to Part Number vs. Product Code)
- ④ : Type (B,D)
- ⑤, ⑥ : Lot Number

• Part Number vs. Product Code

| Part Number | Product Code | | | |
|-------------|--------------|---|---|---|
| | ① | ② | ③ | ④ |
| R1173D081B | H | 0 | 8 | B |
| R1173D091B | H | 0 | 9 | B |
| R1173D101B | H | 1 | 0 | B |
| R1173D111B | H | 1 | 1 | B |
| R1173D121B | H | 1 | 2 | B |
| R1173D131B | H | 1 | 3 | B |
| R1173D141B | H | 1 | 4 | B |
| R1173D151B | H | 1 | 5 | B |
| R1173D161B | H | 1 | 6 | B |
| R1173D171B | H | 1 | 7 | B |
| R1173D181B | H | 1 | 8 | B |
| R1173D191B | H | 1 | 9 | B |
| R1173D201B | H | 2 | 0 | B |
| R1173D211B | H | 2 | 1 | B |
| R1173D221B | H | 2 | 2 | B |
| R1173D231B | H | 2 | 3 | B |
| R1173D241B | H | 2 | 4 | B |
| R1173D251B | H | 2 | 5 | B |
| R1173D261B | H | 2 | 6 | B |
| R1173D271B | H | 2 | 7 | B |
| R1173D281B | H | 2 | 8 | B |
| R1173D291B | H | 2 | 9 | B |
| R1173D301B | H | 3 | 0 | B |

| Part Number | Product Code | | | |
|-------------|--------------|---|---|---|
| | ① | ② | ③ | ④ |
| R1173D311B | H | 3 | 1 | B |
| R1173D321B | H | 3 | 2 | B |
| R1173D331B | H | 3 | 3 | B |
| R1173D341B | H | 3 | 4 | B |
| R1173D351B | H | 3 | 5 | B |
| R1173D361B | H | 3 | 6 | B |
| R1173D371B | H | 3 | 7 | B |
| R1173D381B | H | 3 | 8 | B |
| R1173D391B | H | 3 | 9 | B |
| R1173D401B | H | 4 | 0 | B |
| R1173D411B | H | 4 | 1 | B |
| R1173D421B | H | 4 | 2 | B |
| R1173D431B | H | 4 | 3 | B |
| R1173D441B | H | 4 | 4 | B |
| R1173D451B | H | 4 | 5 | B |
| R1173D461B | H | 4 | 6 | B |
| R1173D471B | H | 4 | 7 | B |
| R1173D481B | H | 4 | 8 | B |
| R1173D491B | H | 4 | 9 | B |
| R1173D501B | H | 5 | 0 | B |
| R1173D181B5 | H | 0 | 1 | B |
| R1173D281B5 | H | 0 | 2 | B |
| R1173D001B | H | 0 | 0 | B |

| Part Number | Product Code | | | |
|-------------|--------------|---|---|---|
| | ① | ② | ③ | ④ |
| R1173D081D | H | 0 | 8 | D |
| R1173D091D | H | 0 | 9 | D |
| R1173D101D | H | 1 | 0 | D |
| R1173D111D | H | 1 | 1 | D |
| R1173D121D | H | 1 | 2 | D |
| R1173D131D | H | 1 | 3 | D |
| R1173D141D | H | 1 | 4 | D |
| R1173D151D | H | 1 | 5 | D |
| R1173D161D | H | 1 | 6 | D |
| R1173D171D | H | 1 | 7 | D |
| R1173D181D | H | 1 | 8 | D |
| R1173D191D | H | 1 | 9 | D |
| R1173D201D | H | 2 | 0 | D |
| R1173D211D | H | 2 | 1 | D |
| R1173D221D | H | 2 | 2 | D |
| R1173D231D | H | 2 | 3 | D |
| R1173D241D | H | 2 | 4 | D |
| R1173D251D | H | 2 | 5 | D |
| R1173D261D | H | 2 | 6 | D |
| R1173D271D | H | 2 | 7 | D |
| R1173D281D | H | 2 | 8 | D |
| R1173D291D | H | 2 | 9 | D |
| R1173D301D | H | 3 | 0 | D |

| Part Number | Product Code | | | |
|-------------|--------------|---|---|---|
| | ① | ② | ③ | ④ |
| R1173D311D | H | 3 | 1 | D |
| R1173D321D | H | 3 | 2 | D |
| R1173D331D | H | 3 | 3 | D |
| R1173D341D | H | 3 | 4 | D |
| R1173D351D | H | 3 | 5 | D |
| R1173D361D | H | 3 | 6 | D |
| R1173D371D | H | 3 | 7 | D |
| R1173D381D | H | 3 | 8 | D |
| R1173D391D | H | 3 | 9 | D |
| R1173D401D | H | 4 | 0 | D |
| R1173D411D | H | 4 | 1 | D |
| R1173D421D | H | 4 | 2 | D |
| R1173D431D | H | 4 | 3 | D |
| R1173D441D | H | 4 | 4 | D |
| R1173D451D | H | 4 | 5 | D |
| R1173D461D | H | 4 | 6 | D |
| R1173D471D | H | 4 | 7 | D |
| R1173D481D | H | 4 | 8 | D |
| R1173D491D | H | 4 | 9 | D |
| R1173D501D | H | 5 | 0 | D |
| R1173D181D5 | H | 0 | 1 | D |
| R1173D281D5 | H | 0 | 2 | D |
| R1173D001D | H | 0 | 0 | D |

R1173S SERIES MARK SPECIFICATION

● HSOP-6J

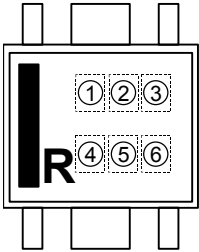

- ① : C (fixed)
 - ②, ③ : Setting Voltage
 - ④ : Type (B,D)
 - ⑤, ⑥ : Lot Number
- } (refer to Part Number vs. Product Code)

● Part Number vs. Product Code

| Part Number | Product Code | | | |
|-------------|--------------|---|---|---|
| | ① | ② | ③ | ④ |
| R1173S081B | C | 0 | 8 | B |
| R1173S091B | C | 0 | 9 | B |
| R1173S101B | C | 1 | 0 | B |
| R1173S111B | C | 1 | 1 | B |
| R1173S121B | C | 1 | 2 | B |
| R1173S131B | C | 1 | 3 | B |
| R1173S141B | C | 1 | 4 | B |
| R1173S151B | C | 1 | 5 | B |
| R1173S161B | C | 1 | 6 | B |
| R1173S171B | C | 1 | 7 | B |
| R1173S181B | C | 1 | 8 | B |
| R1173S191B | C | 1 | 9 | B |
| R1173S201B | C | 2 | 0 | B |
| R1173S211B | C | 2 | 1 | B |
| R1173S221B | C | 2 | 2 | B |
| R1173S231B | C | 2 | 3 | B |
| R1173S241B | C | 2 | 4 | B |
| R1173S251B | C | 2 | 5 | B |
| R1173S261B | C | 2 | 6 | B |
| R1173S271B | C | 2 | 7 | B |
| R1173S281B | C | 2 | 8 | B |
| R1173S291B | C | 2 | 9 | B |
| R1173S301B | C | 3 | 0 | B |
| R1173S311B | C | 3 | 1 | B |
| R1173S321B | C | 3 | 2 | B |
| R1173S331B | C | 3 | 3 | B |
| R1173S341B | C | 3 | 4 | B |
| R1173S351B | C | 3 | 5 | B |
| R1173S181B5 | C | 0 | 1 | B |
| R1173S281B5 | C | 0 | 2 | B |
| R1173S001B | C | 0 | 0 | B |

| Part Number | Product Code | | | |
|-------------|--------------|---|---|---|
| | ① | ② | ③ | ④ |
| R1173S081D | C | 0 | 8 | D |
| R1173S091D | C | 0 | 9 | D |
| R1173S101D | C | 1 | 0 | D |
| R1173S111D | C | 1 | 1 | D |
| R1173S121D | C | 1 | 2 | D |
| R1173S131D | C | 1 | 3 | D |
| R1173S141D | C | 1 | 4 | D |
| R1173S151D | C | 1 | 5 | D |
| R1173S161D | C | 1 | 6 | D |
| R1173S171D | C | 1 | 7 | D |
| R1173S181D | C | 1 | 8 | D |
| R1173S191D | C | 1 | 9 | D |
| R1173S201D | C | 2 | 0 | D |
| R1173S211D | C | 2 | 1 | D |
| R1173S221D | C | 2 | 2 | D |
| R1173S231D | C | 2 | 3 | D |
| R1173S241D | C | 2 | 4 | D |
| R1173S251D | C | 2 | 5 | D |
| R1173S261D | C | 2 | 6 | D |
| R1173S271D | C | 2 | 7 | D |
| R1173S281D | C | 2 | 8 | D |
| R1173S291D | C | 2 | 9 | D |
| R1173S301D | C | 3 | 0 | D |
| R1173S311D | C | 3 | 1 | D |
| R1173S321D | C | 3 | 2 | D |
| R1173S331D | C | 3 | 3 | D |
| R1173S341D | C | 3 | 4 | D |
| R1173S351D | C | 3 | 5 | D |
| R1173S181D5 | C | 0 | 1 | D |
| R1173S281D5 | C | 0 | 2 | D |
| R1173S001D | C | 0 | 0 | D |

Компания «Океан Электроники» предлагает заключение долгосрочных отношений при поставках импортных электронных компонентов на взаимовыгодных условиях!

Наши преимущества:

- Поставка оригинальных импортных электронных компонентов напрямую с производств Америки, Европы и Азии, а так же с крупнейших складов мира;
- Широкая линейка поставок активных и пассивных импортных электронных компонентов (более 30 млн. наименований);
- Поставка сложных, дефицитных, либо снятых с производства позиций;
- Оперативные сроки поставки под заказ (от 5 рабочих дней);
- Экспресс доставка в любую точку России;
- Помощь Конструкторского Отдела и консультации квалифицированных инженеров;
- Техническая поддержка проекта, помощь в подборе аналогов, поставка прототипов;
- Поставка электронных компонентов под контролем ВП;
- Система менеджмента качества сертифицирована по Международному стандарту ISO 9001;
- При необходимости вся продукция военного и аэрокосмического назначения проходит испытания и сертификацию в лаборатории (по согласованию с заказчиком);
- Поставка специализированных компонентов военного и аэрокосмического уровня качества (Xilinx, Altera, Analog Devices, Intersil, Interpoint, Microsemi, Actel, Aeroflex, Peregrine, VPT, Syfer, Eurofarad, Texas Instruments, MS Kennedy, Miteq, Cobham, E2V, MA-COM, Hittite, Mini-Circuits, General Dynamics и др.);

Компания «Океан Электроники» является официальным дистрибьютором и эксклюзивным представителем в России одного из крупнейших производителей разъемов военного и аэрокосмического назначения «JONHON», а так же официальным дистрибьютором и эксклюзивным представителем в России производителя высокотехнологичных и надежных решений для передачи СВЧ сигналов «FORSTAR».



JONHON

«JONHON» (основан в 1970 г.)

Разъемы специального, военного и аэрокосмического назначения:

(Применяются в военной, авиационной, аэрокосмической, морской, железнодорожной, горно- и нефтедобывающей отраслях промышленности)

«FORSTAR» (основан в 1998 г.)

ВЧ соединители, коаксиальные кабели, кабельные сборки и микроволновые компоненты:

(Применяются в телекоммуникациях гражданского и специального назначения, в средствах связи, РЛС, а так же военной, авиационной и аэрокосмической отраслях промышленности).



Телефон: 8 (812) 309-75-97 (многоканальный)

Факс: 8 (812) 320-03-32

Электронная почта: ocean@oceanchips.ru

Web: <http://oceanchips.ru/>

Адрес: 198099, г. Санкт-Петербург, ул. Калинина, д. 2, корп. 4, лит. А