



SA56004X

SMBus-compatible, 8-pin, remote/local digital temperature sensor with overtemperature alarms

Rev. 7 — 25 February 2013

Product data sheet

1. General description

The NXP Semiconductors SA56004X is an SMBus compatible, 11-bit remote/local digital temperature sensor with overtemperature alarms. The remote channel of the SA56004X monitors a diode junction, such as a substrate PNP of a microprocessor or a diode connected transistor such as the 2N3904 (NPN) or 2N3906 (PNP). With factory trimming, remote sensor accuracy of ± 1 °C is achieved.

Undertemperature and overtemperature alert thresholds can be programmed to cause the $\overline{\text{ALERT}}$ output to indicate when the on-chip or remote temperature is out of range. This output may be used as a system interrupt or SMBus alert. The $\overline{\text{T_CRIT}}$ output is activated when the on-chip or remote temperature measurement rises above the programmed T_CRIT threshold register value. This output may be used to activate a cooling fan, send a warning or trigger a system shutdown. To enhance system reliability further, the SA56004X employs an SMBus time-out protocol. The SA56004X has a unique device architecture.

The SA56004X is available in the SO8, TSSOP8 and HVSON8 packages. SA56004X has 8 factory-programmed device address options. The SA56004X is pin-compatible with the LM86, MAX6657/8, and ADM1032.

2. Features and benefits

- Accurately senses temperature of remote microprocessor thermal diodes or diode connected transistors within ± 1 °C
- On-chip local temperature sensing within ± 2 °C
- Temperature range of -40 °C to $+125$ °C
- 11-bit, 0.125 °C resolution
- 8 different device addresses are available for server applications. The SA56004ED with marking code 56004E, and SA56004EDP with marking code 6004E are address compatible with the National LM86, the MAX6657/8 and the ADM1032.
- Offset registers available for adjusting the remote temperature accuracy
- Programmable under/overtemperature alarms: $\overline{\text{ALERT}}$ and $\overline{\text{T_CRIT}}$
- SMBus 2.0 compatible interface, supports TIMEOUT
- Operating voltage range: 3.0 V to 3.6 V
- I²C-bus Standard-mode and Fast-mode compatible
- SO8, TSSOP8 and HVSON8 packages
- Programmable conversion rate (0.0625 Hz to 26 Hz)
- Undervoltage lockout prevents erroneous temperature readings
- Latch-up testing is done to JEDEC Standard JESD78 which exceeds 100 mA



3. Applications

- System thermal management in laptops, desktops, servers and workstations
- Computers and office electronic equipment
- Electronic test equipment and instrumentation
- HVAC
- Industrial controllers and embedded systems

4. Ordering information

Table 1. Ordering information

Type number ^[1]	Topside marking	Package		
		Name	Description	Version
SA56004AD	56004AD	SO8	plastic small outline package; 8 leads; body width 3.9 mm	SOT96-1
SA56004BD	56004BD			
SA56004CD	56004CD			
SA56004DD	56004DD			
SA56004ED	56004ED			
SA56004FD	56004FD			
SA56004GD	56004GD			
SA56004HD	56004HD			
SA56004ADP	6004A	TSSOP8	plastic thin shrink small outline package; 8 leads; body width 3 mm	SOT505-1
SA56004BDP	6004B			
SA56004CDP	6004C			
SA56004DDP	6004D			
SA56004EDP	6004E			
SA56004FDP	6004F			
SA56004GDP	6004G			
SA56004HDP	6004H			
SA56004ATK	6004A	HVSON8	plastic thermal enhanced very thin small outline package; no leads; 8 terminals; body 3 × 3 × 0.85 mm	SOT782-1
SA56004ETK	6004E			

[1] There are 8 device slave address options, as described in [Table 4](#).

4.1 Ordering options

Table 2. Ordering options

Type number	Orderable part number	Package	Packing method	Minimum order quantity	Temperature
SA56004AD	SA56004AD,112	SO8	Tube, bulk pack	2000	$T_{amb} = -40\text{ °C to }+125\text{ °C}$
	SA56004AD,118	SO8	Reel pack, SMD, 13-inch	2500	$T_{amb} = -40\text{ °C to }+125\text{ °C}$
SA56004BD	SA56004BD,112	SO8	Tube, bulk pack	2000	$T_{amb} = -40\text{ °C to }+125\text{ °C}$
	SA56004BD,118	SO8	Reel pack, SMD, 13-inch	2500	$T_{amb} = -40\text{ °C to }+125\text{ °C}$
SA56004CD	SA56004CD,112	SO8	Tube, bulk pack	2000	$T_{amb} = -40\text{ °C to }+125\text{ °C}$
	SA56004CD,118	SO8	Reel pack, SMD, 13-inch	2500	$T_{amb} = -40\text{ °C to }+125\text{ °C}$
SA56004DD	SA56004DD,112	SO8	Tube, bulk pack	2000	$T_{amb} = -40\text{ °C to }+125\text{ °C}$
	SA56004DD,118	SO8	Reel pack, SMD, 13-inch	2500	$T_{amb} = -40\text{ °C to }+125\text{ °C}$
SA56004ED	SA56004ED,112	SO8	Tube, bulk pack	2000	$T_{amb} = -40\text{ °C to }+125\text{ °C}$
	SA56004ED,118	SO8	Reel pack, SMD, 13-inch	2500	$T_{amb} = -40\text{ °C to }+125\text{ °C}$
SA56004FD	SA56004FD,112	SO8	Tube, bulk pack	2000	$T_{amb} = -40\text{ °C to }+125\text{ °C}$
	SA56004FD,118	SO8	Reel pack, SMD, 13-inch	2500	$T_{amb} = -40\text{ °C to }+125\text{ °C}$
SA56004GD	SA56004GD,118	SO8	Reel pack, SMD, 13-inch	2500	$T_{amb} = -40\text{ °C to }+125\text{ °C}$
SA56004HD	SA56004HD,112	SO8	Tube, bulk pack	2000	$T_{amb} = -40\text{ °C to }+125\text{ °C}$
	SA56004HD,118	SO8	Reel pack, SMD, 13-inch	2500	$T_{amb} = -40\text{ °C to }+125\text{ °C}$
SA56004ADP	SA56004ADP,118	TSSOP8	Reel pack, SMD, 13-inch	2500	$T_{amb} = -40\text{ °C to }+125\text{ °C}$
SA56004BDP	SA56004BDP,118	TSSOP8	Reel pack, SMD, 13-inch	2500	$T_{amb} = -40\text{ °C to }+125\text{ °C}$
SA56004CDP	SA56004CDP,118	TSSOP8	Reel pack, SMD, 13-inch	2500	$T_{amb} = -40\text{ °C to }+125\text{ °C}$
SA56004DDP	SA56004DDP,118	TSSOP8	Reel pack, SMD, 13-inch	2500	$T_{amb} = -40\text{ °C to }+125\text{ °C}$
SA56004EDP	SA56004EDP,118	TSSOP8	Reel pack, SMD, 13-inch	2500	$T_{amb} = -40\text{ °C to }+125\text{ °C}$
SA56004FDP	SA56004FDP,118	TSSOP8	Reel pack, SMD, 13-inch	2500	$T_{amb} = -40\text{ °C to }+125\text{ °C}$
SA56004GDP	SA56004GDP,118	TSSOP8	Reel pack, SMD, 13-inch	2500	$T_{amb} = -40\text{ °C to }+125\text{ °C}$
SA56004HDP	SA56004HDP,118	TSSOP8	Reel pack, SMD, 13-inch	2500	$T_{amb} = -40\text{ °C to }+125\text{ °C}$
SA56004ATK	SA56004ATK,118	HVSON8	Reel pack, SMD, 13-inch	6000	$T_{amb} = -40\text{ °C to }+125\text{ °C}$
SA56004ETK	SA56004ETK,118	HVSON8	Reel pack, SMD, 13-inch	6000	$T_{amb} = -40\text{ °C to }+125\text{ °C}$

5. Block diagram



Fig 1. Block diagram

6. Pinning information

6.1 Pinning



6.2 Pin description

Table 3. Pin description

Symbol	Pin	Description
V _{DD}	1	Positive supply voltage. DC voltage from 3.0 V to 5.5 V.
D+	2	Diode current source (anode).
D-	3	Diode sink current (cathode).
T _{CRIT}	4	T _{CRIT} alarm is open-drain, active LOW output which requires an external pull-up resistor. It functions as a system interrupt or power shutdown.
GND	5	Power supply ground.
ALERT	6	ALERT alarm is an open-drain, active LOW output which requires an external pull-up resistor. It functions as an interrupt indicating that the temperature of the on-chip or remote diode is above or below programmed overtemperature or undertemperature thresholds.
SDATA	7	SMBus/I ² C-bus bidirectional data line. This is an open-drain output which requires an external pull-up resistor.
SCLK	8	SMBus/I ² C-bus clock input which requires an external pull-up resistor.

7. Functional description

Refer to [Figure 1 “Block diagram”](#).

7.1 Serial bus interface

The SA56004X should be connected to a compatible two-wire serial interface System Management Bus (SMBus) as a slave device using the two device terminals SCLK and SDATA. The $\overline{\text{ALERT}}$ pin can optionally be used with the SMBus protocol to implement the ARA response. The controller provides a clock signal to the device SCLK pin and write/read data to/from the device through the device SDATA pin. External pull-up resistors, about 10 k Ω each, are needed for these device pins due to open-drain circuitry.

Data of 8-bit digital byte or word are used for communication between the controller and the device using SMBus 2.0 protocols which are described more in [Section 7.10 “SMBus interface”](#). The operation of the device to the bus is described with details in the following sections.

7.2 Slave address

The SA56004X has a 7-bit slave address register which is factory programmed in OTP memory. Eight unique devices are available with different slave addresses as defined in [Table 4](#). Up to eight devices can reside on the same SMBus without conflict, if their addresses are unique.

Table 4. Slave addresses

Type number	Device slave address ^[1]
SA56004AD	1001 000
SA56004ADP	
SA56004ATK	
SA56004BD	1001 001
SA56004BDP	
SA56004CD	1001 010
SA56004CDP	
SA56004DD	1001 011
SA56004DDP	
SA56004ED ^[2]	1001 100
SA56004EDP ^[2]	
SA56004ETK ^[2]	
SA56004FD	1001 101
SA56004FDP	
SA56004GD	1001 110
SA56004GDP	
SA56004HD	1001 111
SA56004HDP	

[1] The device slave address is factory programmed in OTP device address register.

[2] The SA56004ED/EDP/ETK has the bus address of the National LM86, MAX6657/8 and the ADM1032.

7.3 Register overview

The SA56004X contains three types of SMBus addressable registers: read-only (R), write-only (W), and read-write (R/W). Attempting to write to any R-only register or read data from any W-only register produces an invalid result. Some of the R/W registers have separate addresses for reading and writing operations.

The registers of the SA56004X serve four purposes:

- Control and configuration of the SA56004X
- Status reporting
- Temperature measurement storage
- ID and manufacturer test registers

[Table 5](#) describes the names, addresses, Power-On Reset (POR), and functions of each register. The data of the temperature-related registers is in two's complement format in which the MSB is the sign bit. The 8-bit data of other registers is in 8-bit straight format.

Table 5. Register assignments

Register name	Command byte		POR state	Function	Bits	Access
	Read address	Write address				
LTHB	00h	n/a	0000 0000	local temperature high byte	8	R
RTHB	01h	n/a	0000 0000	remote temperature high byte	8	R
SR	02h	n/a	0000 0000	status register	8	R
CON	03h	09h	0000 0000	configuration register	8	R/W
CR	04h	0Ah	1000	conversion rate	4	R/W
LHS	05h	0Bh	0100 0110	local high setpoint	8	R/W
LLS	06h	0Ch	0000 0000	local low setpoint	8	R/W
RHSHB	07h	0Dh	0100 0110	remote high setpoint high byte	8	R/W
RLSHB	08h	0Eh	0000 0000	remote low setpoint high byte	8	R/W
One Shot	n/a	0Fh	-	writing register initiates a one-shot conversion	0	W
RTLB	10h	n/a	0000 00	remote temperature low byte	6 (MSBs)	R
RTOHB	11h	11h	0000 0000	remote temperature offset high byte	8	R/W
RTOLB	12h	12h	000	remote temperature offset low byte	3 (MSBs)	R/W
RHSLB	13h	13h	000	remote high setpoint low byte	3 (MSBs)	R/W
RLSLB	14h	14h	000	remote low setpoint low byte	3 (MSBs)	R/W
RCS	19h	19h	0101 0101	remote T_CRIT setpoint	8	R/W
LCS	20h	20h	0101 0101	local T_CRIT setpoint	8	R/W
TH	21h	21h	0 1010	T_CRIT hysteresis	5	R/W
ATLB	22h	n/a	0000 0000	local temperature low byte	3 (MSBs)	R
AM	BFh	BFh	0	Alert mode	1	R/W
RMID	FEh	n/a	1010 0001	read manufacturer's ID	8	R
RDR	FFh	n/a	0000 0000	read stepping or die revision	8	R

7.4 Power-on reset

When power is applied to the SA56004X, the device enters its Power-On Reset (POR) state and its registers are reset to their default values. The configuration, status, and temperature-reading registers remain in these states until after the first conversion. As shown in [Table 5](#) this results in:

1. Command register set to 00h.
2. Local Temperature register (LTHB and LTLB) set to 0 °C.
3. Remote Diode Temperature register (RTHB and RTLB) set to 0 °C until the end of the first conversion.
4. Status register (SR) set to 00h.
5. Configuration register (CON) set to 00h; interrupt latches are cleared, the ALERT and T_CRIT output drivers are off and the ALERT and T_CRIT pins are pulled HIGH by the external pull-up resistors.
6. Local T_CRIT temperature setpoints (LCS) and Remote T_CRIT temperature setpoints (RCS) at 85 °C.
7. Local HIGH setpoint (LHS) and remote HIGH temperature setpoint (RHSHB) at 70 °C.

8. Local LOW setpoint (LLS) and Remote LOW temperature setpoints (RLSHB) at 0 °C.
9. Conversion Rate register (CR) is set to 8h; the default value of about 16 conversions/s.

7.5 Starting conversion

Upon POR, the RUN/STOP bit 6 of the configuration register is zero (default condition), then, the device enters into its free-running operation mode in which the device A/D converter is enabled and the measurement function is activated. In this mode, the device cycles the measurements of the local and remote temperature automatically and periodically. The conversion rate is defined by the programmable conversion rate stored in the conversion rate register. It also performs comparison between readings and limits of the temperature in order to set the flags and interruption accordingly at the end of every conversion. Measured values are stored in the temp registers, results of the limit comparisons are reflected by the status of the flag bits in the status register and the interruption is reflected by the logical level of the ALERT and T_CRIT output. If the power-on temperature limit is not suitable, the temp limit values could be written into the limit registers during the busy-conversion duration of about 38 ms of the first conversion after power-up. Otherwise, the status register must be read and the configuration bit 7 must be reset in order to recover the device from interruption caused by the undesired temp limits.

7.6 Low power software standby mode

The device can be placed in a software standby mode by setting the RUN/STOP bit 6 in the configuration register HIGH (logic 1). In standby, the free-running oscillator is stopped, the supply current is less than 10 μ A if there is no SMBus activity, all data in the registers is retained. However, the SMBus is still active and reading and writing registers can still be performed. A one-shot command initiates a single conversion which has the same effect as any conversion that occurs when the device is in its free-running mode. To restore the device to free running mode, set the RUN/STOP bit 6 LOW (logic 0).

7.7 Temperature data format

The temperature data can only be read from the Local and Remote Temperature registers; the setpoint registers (for example, T_CRIT, LOW, HIGH) are read/write.

Both local and remote temperature reading data is represented by an 11-bit, two's complement word with the Least Significant Bit (LSB) = 0.125 °C. The temperature setpoint data for the remote channel is also represented by an 11-bit, two's complement word with the LSB = 0.125 °C. The temperature setpoint data for both the local channel and the T_CRIT setpoints are represented by 8-bit, two's complement words with the LSB = 1.0 °C. For 11-bit temp data, the data format is a left justified, 16-bit word available in two 8-bit registers (high byte and low byte). For 8-bit temp data, the data is available in a single 8-bit register (high byte only).

Table 6. Temperature data format

Temperature	Digital output	
	Binary	Hexadecimal
+125 °C	0111 1101 0000 0000	7D00h
+25 °C	0001 1001 0000 0000	1900h
+1 °C	0000 0001 0000 0000	0100h
+0.125 °C	0000 0000 0010 0000	0020h
0 °C	0000 0000 0000 0000	0000h
-0.125 °C	1111 1111 1110 0000	FFE0h
-1 °C	1111 1111 0000 0000	FF00h
-25 °C	1110 0111 0000 0000	E700h
-55 °C	1100 1001 0000 0000	C900h

7.8 SA56004X SMBus registers

7.8.1 Command register

The command register selects which register will be read or written to. Data for this register should be transmitted during the Command Byte of the SMBus write communication.

7.8.2 Local and remote temperature registers (LTHB, LTLB, RTHB, RTLB)

Table 7. LTHB, LTLB, RTHB, RTLB - Local and remote temperature registers

Byte	High byte (read only; address 00h, 01h)								Low byte (read only; address 10h)							
Bit	D7	D6	D5	D4	D3	D2	D1	D0	D7	D6	D5	D4	D3	D2	D1	D0
Value	sign	64	32	16	8	4	2	1	0.5	0.25	0.125	0	0	0	0	0

7.8.3 Configuration register (CON)

The configuration register is an 8-bit register with read address 03h and write address 09h. [Table 8](#) shows how the bits in this register are used.

Table 8. CON - Configuration register (read address 03h; write address 09h) bit assignments

Bit	Description	POR state
7	ALERT mask. The ALERT interrupt is enabled when this bit is LOW. The ALERT interrupt is disabled (masked) when this bit is HIGH.	0
6	RUN/STOP. Standby or run mode control. Running mode is enabled when this bit is LOW. The SA56004X is in standby mode when this bit is HIGH.	0
5	Not defined; defaults to logic 0.	0
4	Remote $\overline{T_CRIT}$ mask. The $\overline{T_CRIT}$ output will be activated by a remote temperature that exceeds the remote T_CRIT setpoint when this bit is LOW. The $\overline{T_CRIT}$ output will not be activated under this condition when this bit is HIGH.	0
3	Not defined; defaults to logic 0.	0

Table 8. CON - Configuration register (read address 03h; write address 09h) bit assignments ...continued

Bit	Description	POR state
2	Local $\overline{T_CRIT}$ mask. The $\overline{T_CRIT}$ output will be activated by a local temperature that exceeds the local T_CRIT setpoint when this bit is LOW. The $\overline{T_CRIT}$ output will not be activated under this condition when this bit is HIGH.	0
1	Not defined; defaults to logic 0.	0
0	Fault queue. A single remote temperature measurement outside the HIGH, LOW or T_CRIT setpoints will trigger an outside limit condition resulting in setting the status bits and associated output pins when this bit is LOW. Three consecutive measurements outside of one of these setpoints are required to trigger an outside of limit condition when this bit is HIGH.	0

7.8.4 Status register (SR)

The contents of the status register reflect condition status resulting from all activities: comparison between temperature measurements and temperature limits, the status of A/D conversion, and the hardware condition of external diode to the device. Bit assignments are listed in [Table 9](#). This register is read-only and its address is 02h. Upon POR, all bits are set to zero.

Remark: Any one of the fault conditions, with the exceptions of Diode OPEN and A/D BUSY, introduces an Alert interrupt (see [Section 7.9.1.2](#)). Also, whenever a one-shot command is executed, the status byte should be read after the conversion is completed, which is about 38 ms (1 conversion time period) after the one-shot command is sent.

Table 9. SR - Status register (read-only address 02h) bit assignments

Bit	Name	Description
7	BUSY	When logic 1, A/D is busy converting. POR state = n/a.
6	LHIGH	When logic 1, indicates local HIGH temperature alarm. POR state = 0.
5	LLOW	When logic 1, indicates a local LOW temperature alarm. POR state = 0.
4	RHIGH	When logic 1, indicates a remote diode HIGH temperature alarm. POR state = 0.
3	RLOW	When logic 1, indicates a remote diode LOW temperature alarm. POR state = 0.
2	OPEN	When logic 1, indicates a remote diode disconnect. POR state = 0.
1	RCRIT	When logic 1, indicates a remote diode critical temperature alarm. POR state = 0.
0	LCRIT	When logic 1, indicates a local critical temperature alarm. POR state = 0.

7.8.5 Conversion rate register (CR)

The conversion rate register is used to store programmable conversion data, which defines the time interval between conversions in the standard free-running auto convert mode. [Table 10](#) shows all applicable data values and rates for the SA56004X. Only the 4 LSBs of the register are used and the other bits are reserved for future use. The register is R/W using the read address 04h and write address 0Ah. The POR default conversion data is 08h.

Table 10. Conversion rate control byte (CR)

Data value	Conversion rate (Hz)
00h	0.06
01h	0.12
02h	0.25
03h	0.50
04h	1.0
05h	2
06h	4
07h	8
08h	16
09h	32
0Ah to FFh	n/a

7.8.6 Temperature limit registers

Table 11. LHS, RSHSB, RHSLB - Local and remote HIGH setpoint registers

Byte	High byte (read only address 05h, 07h; write address 0Bh, 0Dh) ^[1]								Low byte (read/write address 13h) ^[2]							
Bit	D7	D6	D5	D4	D3	D2	D1	D0	D7	D6	D5	D4	D3	D2	D1	D0
Value	sign	64	32	16	8	4	2	1	0.5	0.25	0.125	0	0	0	0	0

[1] POR default LHS = RSHSV = 46h (70 °C).

[2] POR default RHSLB = 00h.

Table 12. LLS, RLSHB, RLSLB - Local and remote LOW setpoint registers

Byte	High byte (read address 06h, 08h; write address 0Ch, 0Eh) ^[1]								Low byte (read/write address 14h) ^[2]							
Bit	D7	D6	D5	D4	D3	D2	D1	D0	D7	D6	D5	D4	D3	D2	D1	D0
Value	sign	64	32	16	8	4	2	1	0.5	0.25	0.125	0	0	0	0	0

[1] POR default LLS = RLSHV = 00h.

[2] POR default RLSLB = 00h (0 °C).

Table 13. LCS, RCS - Local and remote T_CRIT registers

Byte	Single high byte (read/write address 20h, 19h) ^[1]							
Bit	D7	D6	D5	D4	D3	D2	D1	D0
Value	sign	64	32	16	8	4	2	1

[1] POR default LCS = RCS = 55h (85 °C).

Table 14. TH - T_CRIT hysteresis register

Byte	Single high byte (read/write address 21h) ^[1]							
Bit	D7	D6	D5	D4	D3	D2	D1	D0
Value	-	-	-	16	8	4	2	1

[1] POR default TH = 0Ah (10 °C).

7.8.7 Programmable offset register (remote only)

Table 15. RTOHB, RTOLB - Remote temperature offset registers

Byte	High byte (read/write address 11h) ^[1]								Low byte (read/write address 12h) ^[2]							
Bit	D7	D6	D5	D4	D3	D2	D1	D0	D7	D6	D5	D4	D3	D2	D1	D0
Value	sign	64	32	16	8	4	2	1	0.5	0.25	0.125	0	0	0	0	0

[1] POR default RTOHB = RTOLB = 00h.

[2] POR default RTOLB = 00h.

7.8.8 ALERT mode register (AM)

Table 16. AM - ALERT mode register

Read and write address BFh.

Bit	D7	D6	D5	D4	D3	D2	D1	D0
Value	0	0	0	0	0	0	0	ALERT mode

D[7:1] is not defined and defaults to logic 0.

D0: The $\overline{\text{ALERT}}$ output is in interrupt mode when this bit is LOW. The $\overline{\text{ALERT}}$ output is in comparator mode when this bit is HIGH.

7.8.9 Other registers

The **Manufacturers ID** register has a default value A1h (1010 0001) and a read address FEh.

The **Die Revision Code** register has a default value 00h (0000 0000) and read address FFh. This register increments by 1 every time there is a revision to the die.

7.8.10 One-shot register

The one-shot register is used to initiate a single conversion and comparison cycle when the device is in the standby mode; upon completion of the single conversion cycle, the device returns to the standby mode. It is not a data register; it is the write operation that causes the one-shot conversion. The data written to this register is not stored; an FFh value will always be read from this register. To initiate a one-shot operation, send a standard write command with the command byte of 0Fh (One-Shot Write Address).

7.9 Interruption logic and functional description

7.9.1 $\overline{\text{ALERT}}$ output

The $\overline{\text{ALERT}}$ output is used to signal Alert interruptions from the device to the SMBus or other system interrupt handler and it is active LOW. Because this is an open-drain output, a pull-up resistor (typically 10 k Ω) to V_{DD} is required. Several slave devices can share a common interrupt line on the same SMBus.

The $\overline{\text{ALERT}}$ function is very versatile and accommodates three separate operating modes:

- Temperature comparator
- System interrupt based on temperature
- SMBus Alert Response Address (ARA) response.

The ARA and interrupt modes are different only in how the user interacts with the SA56004X.

At the end of every temperature reading, digital comparators determine if the readings are above the HIGH or T_CRIT setpoint or below the LOW setpoint register values. If so, the corresponding bit in the Status register is set. If the $\overline{\text{ALERT}}$ mask bit 7 of the Configuration register is not HIGH, then any bit set in the Status register other than the BUSY (D7) and OPEN (D2) causes the $\overline{\text{ALERT}}$ output pin to be active LOW. An alert will be triggered after any conversion cycle that finds the temperature is out of the limits defined by the setpoint registers. In order to trigger an ALERT in all alert modes, the $\overline{\text{ALERT}}$ mask bit 7 of the Configuration register must be cleared (not HIGH).

7.9.1.1 $\overline{\text{ALERT}}$ output in comparator mode

When operating the SA56004X in a system that utilizes an SMBus controller not having an interrupt, the $\overline{\text{ALERT}}$ output may be operated as a temperature comparator. In this mode, when the condition that triggered the ALERT to be asserted is no longer present, the $\overline{\text{ALERT}}$ output is released as it goes HIGH. In order to use the $\overline{\text{ALERT}}$ output as a temperature comparator, bit D0 (the ALERT configure bit) in the ALERT Mode (AM) register must be set HIGH. This is not the POR default.

7.9.1.2 $\overline{\text{ALERT}}$ output in interrupt mode

In the interrupt mode, the $\overline{\text{ALERT}}$ output is used to provide an interrupt signal that remains asserted until the interrupt service routine has elapsed. In the interrupt operating mode, a read of the Status register will set the $\overline{\text{ALERT}}$ mask bit 7 of the Configuration register if any of the temperature alarm bits of the Status register is set, with exception of BUSY (D7) and OPEN (D2). This protocol prevents further $\overline{\text{ALERT}}$ output triggering until the master device has reset the $\overline{\text{ALERT}}$ mask bit at the end of the interrupt service routine. The Status register bits are cleared only upon a read of the Status register by the serial bus master (see [Figure 5](#)). In order for the $\overline{\text{ALERT}}$ output to be used as an interrupt, the ALERT Configure bit D0 of the ALERT Mode (AM) register must be set LOW (POR default).



Fig 5. ALERT output in interrupt mode

The following events summarize the ALERT output interrupt mode of operation:

Event A: Master senses $\overline{\text{ALERT}}$ output being active-LOW.

Event B: Master reads the SA56004X Status register to determine what cause the ALERT interrupt.

Event C: SA56004X clears the Status register, resets the $\overline{\text{ALERT}}$ output HIGH, and sets the ALERT mask bit 7 in the Configuration register.

Event D: A new conversion result indicates that the temperature is still above the high limit, however the $\overline{\text{ALERT}}$ pin is not activated due to the ALERT mask.

Event E: Master should correct the conditions that caused the $\overline{\text{ALERT}}$ output to be triggered. For instance, the fan is started, setpoint levels are adjusted.

Event F: Master resets the ALERT mask bit 7 in the Configuration register.

7.9.1.3 ALERT output in SMBus ALERT mode

When several slave devices share a common interrupt line, an SMBus alert line is implemented. The SA56004X is designed to accommodate the Alert interrupt detection capability of the SMBus 2.0 Alert Response Address (ARA) protocol, defined in *SMBus specification 2.0*. This procedure is designed to assist the master in resolving which slave device generated the interrupt and in servicing the interrupt while minimizing the time to restore the system to its proper operation. Basically, the SMBus provides Alert response interrupt pointers in order to identify slave devices which have caused the Alert interrupt. When the ARA command is received by all devices on the SMBus, the devices pulling the SMBus alert line LOW send their device addresses to the master; await an acknowledgement and then release the alert line. This requirement to disengage the SMBus alert line prevents locking up the alert line. The SA56004X complies with this ARA disengagement protocol by setting the ALERT mask bit 7 in the Configuration register at address 09h after successfully sending out its address in response to an ARA command and releasing the ALERT output. Once the mask bit is activated, the ALERT output is disabled until enabled by software. In order to enable the ALERT the master must read

the Status register, at address 02h, during the interrupt service routine and then reset the ALERT mask bit 7 in the Configuration register to logic 0 at the end of the interrupt service routine (see Figure 6).

In order for the SA56004X to respond to the ARA command, the bit D0 in the ALERT mode register must be set LOW.

ALERT mask bit 7 and the ALERT mode bit D0 are both LOW for the POR default.



Fig 6. ALERT pin in SMBus Alert mode

The following events summarize the ALERT output interrupt operation in the SMBus Alert mode:

Event A: Master senses the ALERT line being LOW.

Event A to B: Master sends a read command using the common 7-bit Alert Response Address (ARA) of 0001100.

Event A to B: Alerting device(s) return ACK signal and their addresses using the I²C-bus Arbitration (the device with the lowest address value sends its address first. The master can repeat the alert reading process and work up through all the interrupts).

Event B: Upon the successful completion of returning address, the SA56004X resets its ALERT output (to OFF) and sets the ALERT mask bit 7 in its configuration register.

Event C: Master should read the device status register to identify and correct the conditions that caused the Alert interruption. The status register is reset.

Event D: Master resets the ALERT mask bit 7 in the configuration register to enable the device ALERT output interruption.

Remark: The bit assignment of the returned data from the ARA reading is listed in Table 17. If none of the devices on the bus is alerted, then the returned data from ARA reading is FFh (1111 1111).

Table 17. ALERT response bit assignment

ALERT response bit	Device address bit	Function
7 (MSB)	ADD6	address bit 6 (MSB) of alerted device
6	ADD5	address bit 5 of alerted device
5	ADD4	address bit 4 of alerted device
4	ADD3	address bit 3 of alerted device
3	ADD2	address bit 2 of alerted device
2	ADD1	address bit 1 of alerted device
1	ADD0	address bit 0 of alerted device
0	1	always logic 1

7.9.2 T_CRIT output

The $\overline{T_CRIT}$ output is LOW when any temperature reading is greater than the preset limit in the corresponding critical temperature setpoint register. When one of the T_CRIT setpoint temperatures is exceeded, the appropriate status register bit, 1 (RCRIT) or 0 (LCRIT), is set.

After every local and remote temperature conversion the status register flags and the $\overline{T_CRIT}$ output are updated. Figure 7 is a timing diagram showing the relationship of $\overline{T_CRIT}$ output, Status bit 1 (RCRIT) and the remote critical temperature setpoint (RCS), and critical temperature hysteresis (TH) with remote temperature changes. Note that the $\overline{T_CRIT}$ output is de-activated only after the remote temperature is below the remote temperature setpoint, RCS minus the hysteresis, TH. In the interrupt mode only, the Status register flags are reset after the Status register is read.



Fig 7. T_CRIT temperature response timing

Event A: $\overline{T_CRIT}$ goes LOW and Status bit 1 (RCRIT) is set HIGH when Remote Temperature exceeds RCS, Remote T_CRIT Setpoint.

Event B: Remote Temperature goes below RCS - TH. $\overline{T_CRIT}$ is de-activated, but Status register remains unchanged.

Event C: The Status register bit 1 (RCRIT) is reset by a read of the Status register (in the interrupt mode).

7.9.3 Fault Queue

To suppress erroneous $\overline{\text{ALERT}}$ or $\overline{\text{T_CRIT}}$ triggering, the SA56004X implements a Fault Queue for both local and remote channel. The Fault Queue insures a temperature measurement is genuinely beyond a HIGH, LOW or T_CRIT setpoint by not triggering until three consecutive out-of-limit measurements have been made. The fault queue defaults OFF upon POR and may be activated by setting bit 0 in the Configuration register (address 09h) to logic 1.

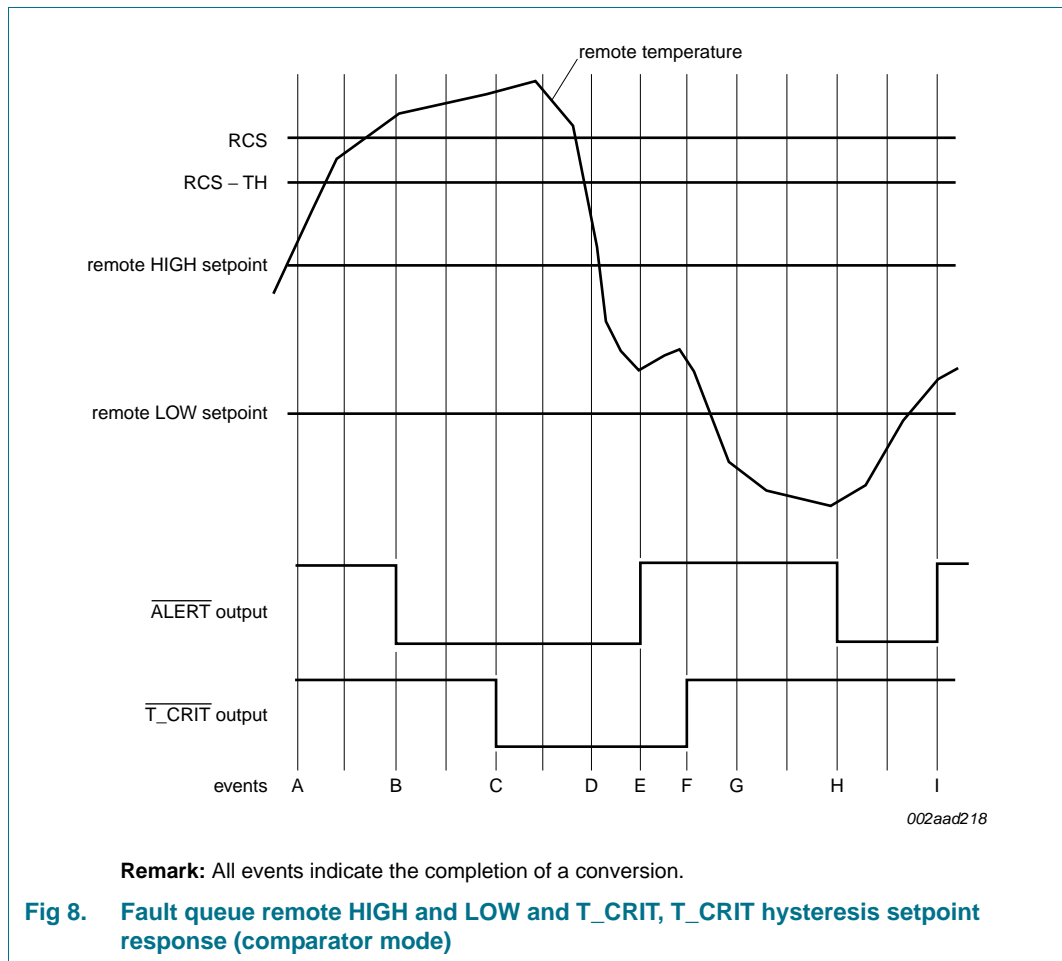

- Event A:** The remote temperature has exceeded the Remote HIGH setpoint.
- Event B:** Three consecutive over limit measurements have been made exceeding the Remote HIGH setpoint; the $\overline{\text{ALERT}}$ output is activated (goes LOW). By now, the remote temp has exceeded the Remote T_CRIT setpoint (RCS).
- Event C:** Three consecutive over limit measurements have been made exceeding RCS; the $\overline{\text{T_CRIT}}$ output is activated (goes LOW).
- Event D:** The remote temperature falls below the RCS - TH setpoint.
- Event E:** The $\overline{\text{ALERT}}$ output is de-activated (goes HIGH) after a below_high_limit temperature measurement is completed.

Event F: Three consecutive measurements have been made with the remote temperature below the RCS – TH threshold; the $\overline{T_CRIT}$ output is de-activated (goes HIGH).

Event G: The remote temp falls below the Remote LOW setpoint.

Event H: Three consecutive measurements are made with the temp below the Remote LOW setpoint; \overline{ALERT} output is activated (goes LOW).

Event I: The \overline{ALERT} output is de-activated (goes HIGH) after a above_low_limit temperature measurement is completed.

7.9.4 Temperature measurement

To measure the remote temperature or the temperature of an externally attached diode, the device automatically forces two successive currents of about 160 μA and 10 μA at D+ pin. It measures the voltage (V_{BE}) between D+ and D–, detects the difference between the two V_{BE} voltages or the ΔV_{BE} and then converts the ΔV_{BE} into a temperature data using the basic PTAT voltage formula as shown in [Equation 1](#). The device typically takes about 38 ms to perform a measurement during each conversion period or cycle, which is selectable by programming the conversion rate register.

$$\Delta V_{BE} = n \times \frac{kT}{q} \times \ln\left(\frac{I2}{I1}\right) \tag{1}$$

Where:

n = diode ideality factor

k = Boltzmann’s constant

T = absolute temperature (°K) = 273 °C + T (°C)

q = electron charge

ln = natural logarithm

I2, I1 = two source currents

Because the device does not directly convert the sensed V_{BE} as in the old method of temperature measurement systems, the V_{BE} calibration is not required. Furthermore, the device remote temperature error is adjusted at the manufacturer to meet the specifications with the use of the reference diode-connected transistors such as the 2N3904/2N3906. The diode type to be used in customer applications must have the characteristics as close to the 2N3904/2N3906 as possible in order to obtain optimal results. Finally, to prevent the effects of system noise on the measured V_{BE} signals, an external capacitor of about 2200 pF connected between the D+ and D– pins as well as the grounded-shield cable for the diode connection wires are recommended.

7.9.5 Diode fault detection

The SA56004X is designed with circuitry to detect the fault conditions of the remote diode. When the D+ pin is shorted to V_{DD} or floating, the Remote Temperature High Byte (RTHB) register is loaded with +127 °C, the Remote Temperature Low Byte (RTLb) register is loaded with 0 °C, and the OPEN bit (bit 2 of the Status register) is set. Under the above conditions of D+ shorted to V_{DD} or floating, if the Remote $\overline{T_CRIT}$ setpoint is set less than +127 °C, and $\overline{T_CRIT}$ Mask are disabled, then, the $\overline{T_CRIT}$ output pins will be pulled

LOW. Furthermore, if the Remote HIGH Setpoint High Byte (RHS HB) register is set to a value less than +127 °C and the Alert Mask is disabled, then the ALERT output will be pulled LOW. Note that the OPEN bit itself will not trigger an ALERT.

When the D+ pin is shorted to ground or to D-, the Remote Temperature High Byte (RTHB) register is loaded with -128 °C (1000 0000) and the OPEN (bit 2 in the Status register) will not be set. Since operating the SA56004X is beyond its normal limits, this temperature reading represents this shorted fault condition. If the value in the Remote Low Setpoint High Byte (RLSHB) register is more than -128 °C and the Alert Mask is disabled, the ALERT output will be pulled LOW.

7.10 SMBus interface

The device can communicate over a standard two-wire serial interface System Management Bus (SMBus) or compatible I²C-bus using SCLK and SDATA. The device employs four standard SMBus protocols: Write Byte, Read Byte, Receive Byte, and Send Byte. Data formats of four protocols are shown in [Figure 9](#). The following key points of protocol are important:

- The SMBus master initiates data transfer by establishing a START condition (S) and terminates data transfer by generating a STOP condition (P).
- Data is sent over the serial bus in sequences of 9 clock pulses according to each 8-bit data byte followed by 1-bit status of device acknowledgement (A).
- The 7-bit slave address is equivalent to factory-programmed address of the device.
- The command byte is equivalent to the address of the selected device register.
- The Receive Byte format is used for quicker transfer data from a device reading register that was previously selected.



a. Write Byte format (to write a data byte to the device register)

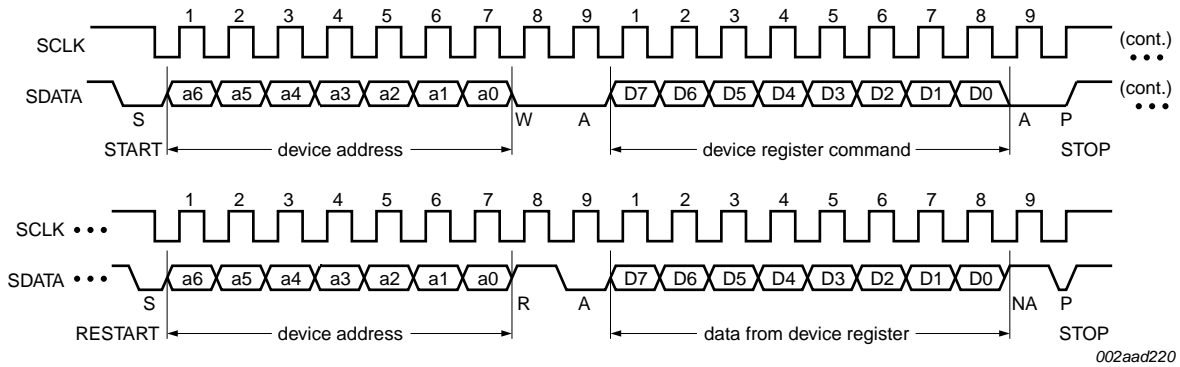

b. Read Byte format (to read a data byte from the device register)

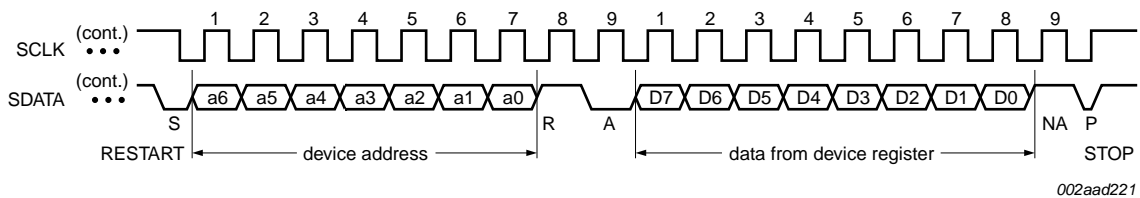

c. Receive Byte format (to read a data byte from already pointed register)

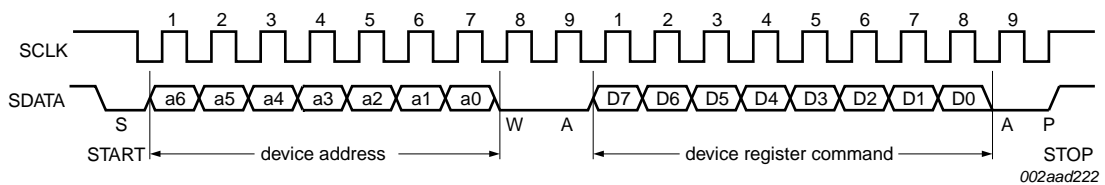

d. Send Byte format

Fig 9. SMBus interface protocols

7.10.1 Serial interface reset

If the SMBus master attempts to reset the SA56004X while the SA56004X is controlling the data line and transmitting on the data line, the SA56004X must be returned to a known state in the communication protocol. This may be accomplished in two ways:

1. When the SDATA is LOW, the SA56004X SMBus state machine resets to the SMBus idle state if SCLK is held LOW for more than 35 ms (maximum TIMEOUT period). According to *SMBus specification 2.0*, all devices are required to time out when the SCLK line is held LOW for 25 ms to 35 ms. Therefore, to insure a time-out of all devices on the bus, the SCLK line must be held LOW for at least 35 ms.
2. When the SDATA is HIGH, the master initiates an SMBus START. The SA56004X responds properly to a SMBus START condition only during the data retrieving cycle. After the START, the SA56004X expects an SMBus Address byte.

8. Application design-in information

8.1 Factors affecting accuracy

8.1.1 Remote sensing diode

The SA56004X is designed to work with substrate transistors built into processors' CPUs or with discrete transistors. Substrate transistors are generally PNP types with the collector connected to the substrate. Discrete types can be either a PNP or an NPN transistor connected as a diode (base shorted to collector). If an NPN transistor is used, the collector and base are connected to D+ and the emitter to D-. If a PNP transistor is used, the collector and base are connected to D- and the emitter to D+. Substrate transistors are found in a number of CPUs. To reduce the error due to variations in these substrate and discrete transistors, a number of factors should be considered:

- The ideality factor, n_f , of the transistor. The ideality factor is a measure of the deviation of the thermal diode from the ideal behavior. The SA56004X is trimmed for an n_f value of 1.008. [Equation 2](#) can be used to calculate the error introduced at a temperature T °C when using a transistor whose n_f does not equal 1.008. Consult the processor data sheet for n_f values.

This value can be written to the offset register and is automatically added to or subtracted from the temperature measurement.

$$\Delta T = \frac{(n_{\text{natural}} - 1.008)}{1.008} \times (273.15 \text{ Kelvin} + T) \quad (2)$$

- Some CPU manufacturers specify the high and low current levels of the substrate transistors. The I_{SOURCE} high current level of the SA56004X is 100 μA and the low-level current is 10 μA .

If a discrete transistor is being used with the SA56004X, the best accuracy is obtained by choosing devices according to the following criteria:

- Base-emitter voltage greater than 0.25 V at 6 mA, at the highest operating temperature.
- Base-emitter voltage less than 0.95 V at 100 mA, at the lowest operating temperature.

- Base resistance less than 100 Ω .
- Small variation in h_{FE} (say 50 to 150) that indicates tight control of V_{BE} characteristics.

Transistors such as 2N3904, 2N3906, or equivalents in SOT23 packages are suitable devices to use. See [Table 18](#) for representative devices.

Table 18. Representative diodes for temperature sensing

Manufacturer	Model number
ROHM	UMT3904
Diodes Inc.	MMBT3904-7
Philips	MMBT3904
ST Micro	MMBT3904
ON Semiconductor	MMBT3904LT1
Chenmko	MMBT3904
Infineon Technologies	SMBT3904E6327
Fairchild Semiconductor	MMBT3904FSCT
National Semiconductor	MMBT3904N623

8.1.2 Thermal inertia and self-heating

Accuracy depends on the temperature of the remote-sensing diode and/or the internal temperature sensor being at the same temperature as that being measured, and a number of factors can affect this. Ideally, the sensor should be in good thermal contact with the part of the system being measured, for example, the processor. If it is not, the thermal inertia caused by the mass of the sensor causes a lag in the response of the sensor to a temperature change. In the case of the remote sensor, this should not be a problem, since it is either a substrate transistor in the processor or a small package device, such as the SOT23, placed close to it.

The on-chip sensor, however, is often remote from the processor and is only monitoring the general ambient temperature around the package. The thermal time constant of the SSOP16 package in still air is about 140 seconds, and if the ambient air temperature quickly changed by 100 $^{\circ}\text{C}$, it would take about 12 minutes (five time constants) for the junction temperature of the SA56004X to settle within 1 $^{\circ}\text{C}$ of this. In practice, the SA56004X package is in electrical and therefore thermal contact with a printed-circuit board and can also be in a forced airflow. How accurately the temperature of the board and/or the forced airflow reflect the temperature to be measured also affects the accuracy.

Self-heating due to the power dissipated in the SA56004X or the remote sensor causes the chip temperature of the device or remote sensor to rise above ambient. However, the current forced through the remote sensor is so small that self-heating is negligible. In the case of the SA56004X, the worst-case condition occurs when the device is converting at 16 conversions per second while sinking the maximum current of 1 mA at the ALERT output. In this case, the total power dissipation in the device is about 11 mW. The thermal resistance, $R_{th(j-a)}$, of the SSOP16 package is about 121 $^{\circ}\text{C}/\text{W}$.

In practice, the package has electrical and therefore thermal connection to the printed circuit board, so the temperature rise due to self-heating is negligible.

8.1.3 Layout considerations

Digital boards can be electrically noisy environments, and the SA56004X is measuring very small voltages from the remote sensor, so care must be taken to minimize noise induced at the sensor inputs. The following precautions should be taken.

1. Place the SA56004X as close as possible to the remote sensing diode. Provided that the worst noise sources, that is, clock generators, data/address buses, and CRTs, are avoided, this distance can be 4 inches to 8 inches.
2. Route the D+ and D- tracks close together, in parallel, with grounded guard tracks on each side. Provide a ground plane under the tracks if possible.
3. Use wide tracks to minimize inductance and reduce noise pickup. 10 mil track minimum width and spacing is recommended (see [Figure 10](#)).
4. Try to minimize the number of copper/solder joints, which can cause thermocouple effects. Where copper/solder joints are used, make sure that they are in both the D+ and D- path and at the same temperature.

Thermocouple effects should not be a major problem since 1 °C corresponds to about 200 μV and thermocouple voltages are about 3 μV/°C of temperature difference. Unless there are two thermocouples with a large temperature differential between them, thermocouple voltages should be much less than 200 μV.

5. Place a 0.1 μF bypass capacitor close to the V_{DD} pin. In very noisy environments, place a 1000 pF input filter capacitor across D+ and D- close to the SA56004X.
6. If the distance to the remote sensor is more than 8 inches, the use of twisted-pair cable is recommended. This works up to about 6 feet to 12 feet.
7. For really long distances (up to 100 feet), use shielded twisted pair, such as Belden #8451 microphone cable. Connect the twisted pair to D+ and D- and the shield to GND close to the SA56004X. Leave the remote end of the shield unconnected to avoid ground loops.

Because the measurement technique uses switched current sources, excessive cable and/or filter capacitance can affect the measurement. When using long cables, the filter capacitor can be reduced or removed.

Cable resistance can also introduce errors. 1 Ω resistance introduces about 1 °C error.

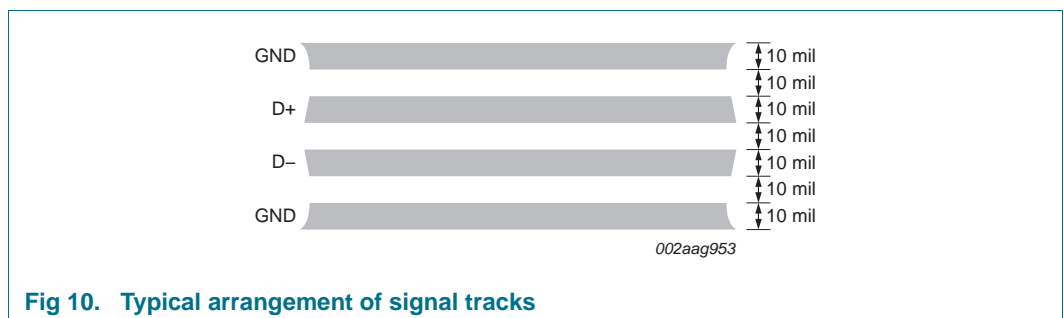

Fig 10. Typical arrangement of signal tracks

8.2 Power sequencing considerations

8.2.1 Power supply slew rate

When powering-up the SA56004X, ensure that the slew rate of V_{DD} is less than $18 \text{ mV}/\mu\text{s}$. A slew rate larger than this may cause power-on reset issues and yield unpredictable results.

8.2.2 Application circuit

Figure 11 shows a typical application circuit for the SA56004X, using a discrete sensor transistor connected via a shielded, twisted-pair cable. The pull-ups on SCLK, SDATA, and $\overline{\text{ALERT}}$ are required only if they are not already provided elsewhere in the system.

The SCLK and SDATA pins of the SA56004X can be interfaced directly to the SMBus of an I/O controller, such as the Intel 820 chip set.

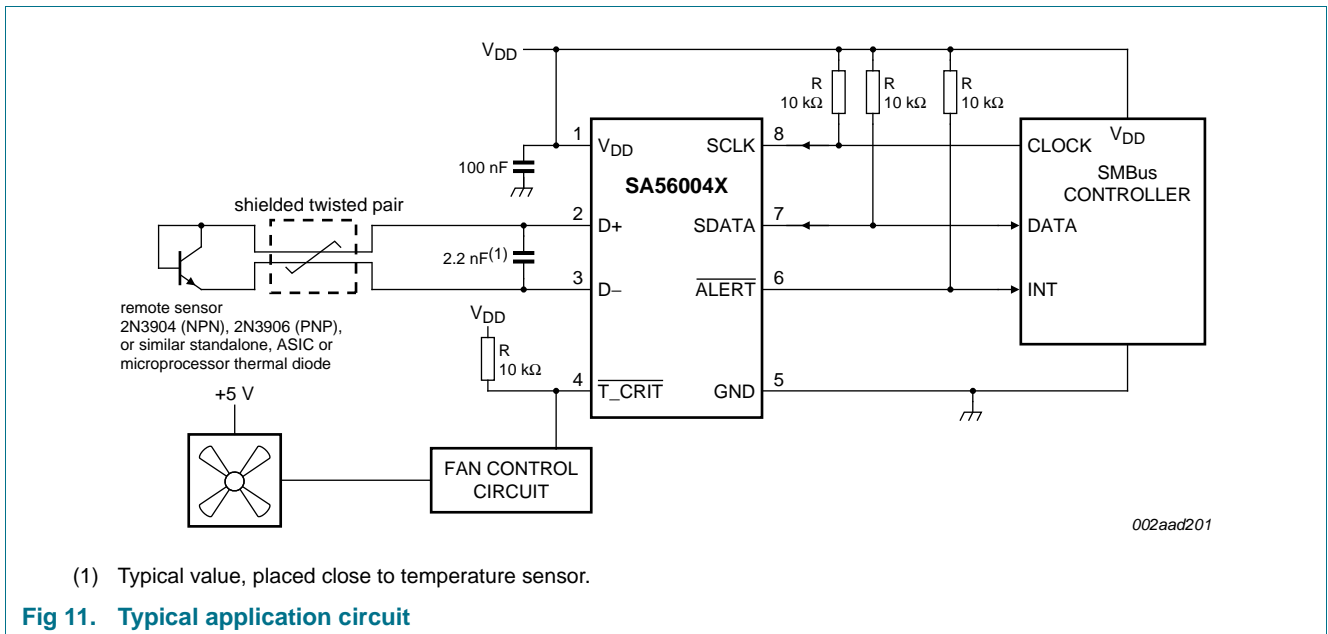

Fig 11. Typical application circuit

8.3 Timing and firmware consideration

It is important not to violate the conversion timing on this part.

Regardless of timing, the device ‘could’ report an erroneous reading, but NXP, nor reporting customers have not encountered two subsequent erroneous readings in its product reviews or evaluations. Masking of single or two sequential erroneous readings is recommended by comparing several reads should there be a large prompt change in the temperature reading before taking protective action.

9. Limiting values

Table 19. Limiting values

In accordance with the Absolute Maximum Rating System (IEC 60134).

All voltages are referenced to GND.

Symbol	Parameter	Conditions	Min	Max	Unit
V _{DD}	supply voltage		-0.3	+6	V
	voltage at SDATA, SCLK, $\overline{\text{ALERT}}$, $\overline{\text{T_CRIT}}$		-0.3	+6	V
V _{D+}	voltage at positive diode input		-0.3	V _{DD} + 0.3	V
V _{D-}	voltage at negative diode input		-0.3	+0.8	V
I _{sink}	sink current	SDATA, SCLK, $\overline{\text{ALERT}}$, $\overline{\text{T_CRIT}}$	-1	+50	mA
I _{D+}	D+ input current		-1	+1	mA
V _{ESD}	electrostatic discharge voltage	Human Body Model	[1] -	2000	V
T _{j(max)}	maximum junction temperature		-	+150	°C
T _{stg}	storage temperature		-65	+165	°C

[1] The D+ and D- pins are 1000 V HBM due to the higher sensitivity of the analog pins that introduces a limitation to the circuit protection structure.

10. Characteristics

Table 20. Electrical characteristics
 $V_{DD} = 3.0\text{ V to }3.6\text{ V}; T_{amb} = -40\text{ }^{\circ}\text{C to }+125\text{ }^{\circ}\text{C};$ unless otherwise specified.

Symbol	Parameter	Conditions	Min	Typ	Max	Unit
T _{ERRL}	local temperature error	T _{amb} = +60 °C to +100 °C	-2	±1	+2	°C
		T _{amb} = -40 °C to +125 °C	-3	-	+3	°C
T _{ERRR}	remote temperature error	T _{amb} = +25 °C to +85 °C; T _{RD} = +60 °C to +100 °C	-1	-	+1	°C
		T _{amb} = -40 °C to +85 °C; T _{RD} = -40 °C to +125 °C	-3	-	+3	°C
T _{RESR}	remote temperature resolution		-	11	-	bit
			-	0.125	-	°C
T _{RESL}	local temperature resolution		-	11	-	bit
			-	0.125	-	°C
T _{conv}	conversion period		-	38	-	ms
V _{DD}	supply voltage		[1] 3.0	-	5.5	V
I _{DD}	quiescent current	during conversion, 16 Hz conversion rate	-	500	-	μA
	shut-down current	SMBus inactive	-	10	-	μA
I _{RD}	remote diode source current	high setting: D+ – D– = +0.65 V	-	160	-	μA
		low setting	-	10	-	μA
V _{th(UVLO)}	undervoltage lockout threshold voltage[2]	V _{DD} input disables A/D conversion	[3] 2.6	-	2.95	V
V _{th(POR)}	power-on reset threshold voltage	V _{DD} input falling edge	[4] 1.8	-	2.4	V
T _{th(high)}	high threshold temperature	local and remote $\overline{\text{ALERT}}$ high default temperature settings; default values set at power-up	-	+70	-	°C
T _{th(low)}	low threshold temperature	local and remote $\overline{\text{ALERT}}$ low default temperature settings; default values set at power-up	-	0	-	°C
T _{th(crit)}	critical threshold temperature	local and remote $\overline{\text{T_CRIT}}$ default temperature settings; default values set at power-up	-	+85	-	°C
T _{hys}	hysteresis temperature	$\overline{\text{T_CRIT}}$; default value set at power-up	-	+10	-	°C
V _{sat}	saturation voltage	$\overline{\text{ALERT}}$ and $\overline{\text{T_CRIT}}$ output; I _O = 6.0 mA	-	-	0.4	V

[1] The SA56004X is optimized for 3.3 V V_{DD} operation.

[2] Definition of UnderVoltage LockOut (UVLO) threshold voltage: The value of V_{DD} below which the internal A/D converter is disabled. This is designed to be a minimum of 200 mV above the power-on reset. While it is disabled, the temperature that is in the 'read temperature registers' remains at the value that it was before the A/D was disabled. This is done to eliminate the possibility of reading unexpected false temperatures due to the A/D converter not working correctly due to low voltage. In case of power-up (rising V_{DD}), the reading that is stored in the 'read temperature registers' will be the default value of 0 °C. V_{DD} will rise to the value of the V_{th(UVLO)}, at which point the A/D functions correctly and the normal temperature is read.

[3] V_{DD} (rising edge) voltage below which the A/D converter is disabled.

[4] V_{DD} (falling edge) voltage below which the logic is reset.

Table 21. SMBus interface characteristics

$V_{DD} = 3.0\text{ V to }3.6\text{ V}$; $T_{amb} = -40\text{ }^{\circ}\text{C to }+125\text{ }^{\circ}\text{C}$; unless otherwise specified.

These specifications are guaranteed by design and not tested in production.

Symbol	Parameter	Conditions	Min	Typ	Max	Unit
V_{IH}	HIGH-level input voltage	SCLK, SDATA; $V_{DD} = 2.7\text{ V to }5.5\text{ V}$	2.2	-	-	V
V_{IL}	LOW-level input voltage	SCLK, SDATA; $V_{DD} = 2.7\text{ V to }5.5\text{ V}$	-	-	0.8	V
I_{OL}	LOW-level output current	$\overline{\text{ALERT}}$, $\overline{\text{T_CRIT}}$; $V_{OL} = 0.4\text{ V}$	1.0	-	-	mA
		SDATA; $V_{OL} = 0.6\text{ V}$	6.0	-	-	mA
I_{OH}	HIGH-level output current		-	-	1.0	μA
I_{IL}	LOW-level input current		-1.0	-	-	μA
I_{IH}	HIGH-level input current		-	-	1.0	μA
C_i	input capacitance	SCLK, SDATA	-	5	-	pF

SMBus digital switching characteristics^[1]

f_{SCLK}	SCLK operating frequency		-	-	400	kHz
t_{LOW}	SCLK LOW time	10 % to 10 %	600	5000	-	ns
t_{HIGH}	SCLK HIGH time	90 % to 90 %	600	5000	-	ns
t_{BUF}	SMBus free time ^[2]		600	-	-	ns
$t_{HD;STA}$	hold time of START condition ^[3]	10 % of SDATA to 90 % of SCLK	600	-	-	ns
$t_{HD;DAT}$	hold time of data ^[4]		0	300	-	ns
$t_{SU;DAT}$	set-up time of data in ^[5]		250	-	-	ns
$t_{SU;STA}$	set-up time of repeat START condition ^[6]	90 % to 90 %	250	-	-	ns
$t_{SU;STO}$	set-up time of STOP condition ^[7]	90 % of SCLK to 90 % of SDATA	250	-	-	ns
t_r	rise time	SCLK and SDATA	-	-	1	μs
t_f	fall time	SCLK and SDATA	-	-	300	ns
t_{of}	output fall time	$C_L = 400\text{ pF}$; $I_O = 3\text{ mA}$	-	-	250	ns
$t_{to(\text{SMBus})}$	SMBus time-out time ^[8]		25	-	35	ms

[1] The switching characteristics of the SA56004X fully meet or exceed all parameters specified in *SMBus version 2.0*. The following parameters specify the timing between the SCLK and SDATA signals in the SA56004X. They adhere to, but are not necessarily specified as the SMBus specifications.

[2] Delay from SDATA STOP to SDATA START.

[3] Delay from SDATA START to first SCLK HIGH-to-LOW transition.

[4] Delay from SCLK HIGH-to-LOW transition to SDATA edges.

[5] Delay from SDATA edges to SCLK LOW-to-HIGH transition.

[6] Delay from SCLK LOW-to-HIGH transition to restart SDATA.

[7] Delay from SCLK HIGH-to-LOW transition to SDATA STOP condition.

[8] LOW period for reset of SMBus.



Fig 12. Timing measurements

11. Performance curves



Fig 13. Typical I_{DD} shutdown versus temperature and V_{DD}

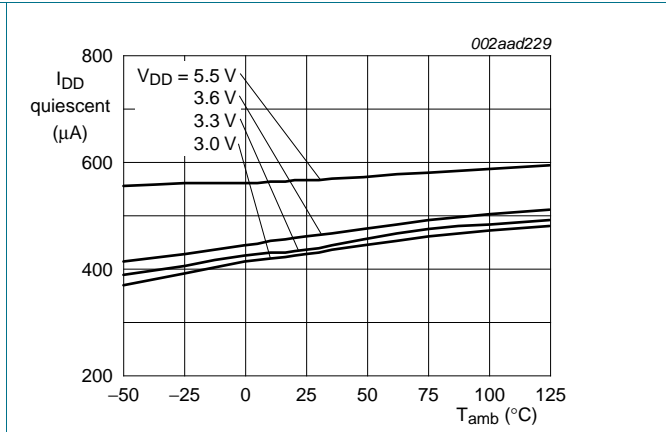
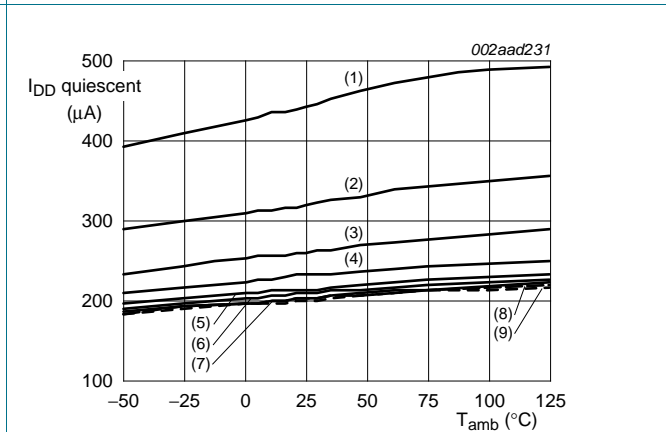

Fig 14. Typical I_{DD} quiescent current versus temperature and V_{DD} (conversion rate = 16 Hz)



Fig 15. Typical I_{DD} quiescent current versus temperature and V_{DD} (conversion rate = 0.06 Hz)



Conversion rate:
 (1) 16 Hz
 (2) 8.0 Hz
 (3) 4.0 Hz
 (4) 2.0 Hz
 (5) 1.0 Hz
 (6) 0.5 Hz
 (7) 0.25 Hz
 (8) 0.12 Hz
 (9) 0.06 Hz

Fig 16. Typical I_{DD} quiescent current versus temperature and conversion rate ($V_{DD} = 3.3$ V)

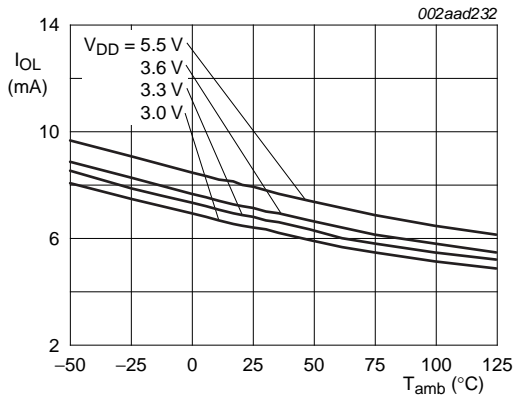

Fig 17. Typical $\overline{\text{CRIT}}$ I_{OL} versus temperature and V_{DD} ($V_{OL} = 0.4 \text{ V}$)



Fig 18. Typical $\overline{\text{ALERT}}$ I_{OL} versus temperature and V_{DD} ($V_{OL} = 0.4 \text{ V}$)

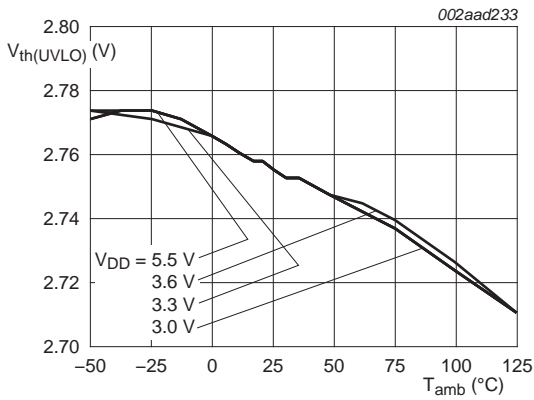

Fig 19. Typical undervoltage lockout threshold voltage versus temperature and V_{DD}

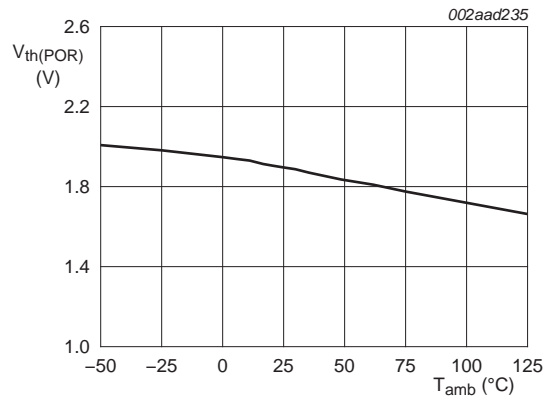

Fig 20. Typical power-on reset threshold voltage versus temperature

12. Package outline

SO8: plastic small outline package; 8 leads; body width 3.9 mm

SOT96-1



Fig 21. Package outline SOT96-1 (SO8)

TSSOP8: plastic thin shrink small outline package; 8 leads; body width 3 mm

SOT505-1

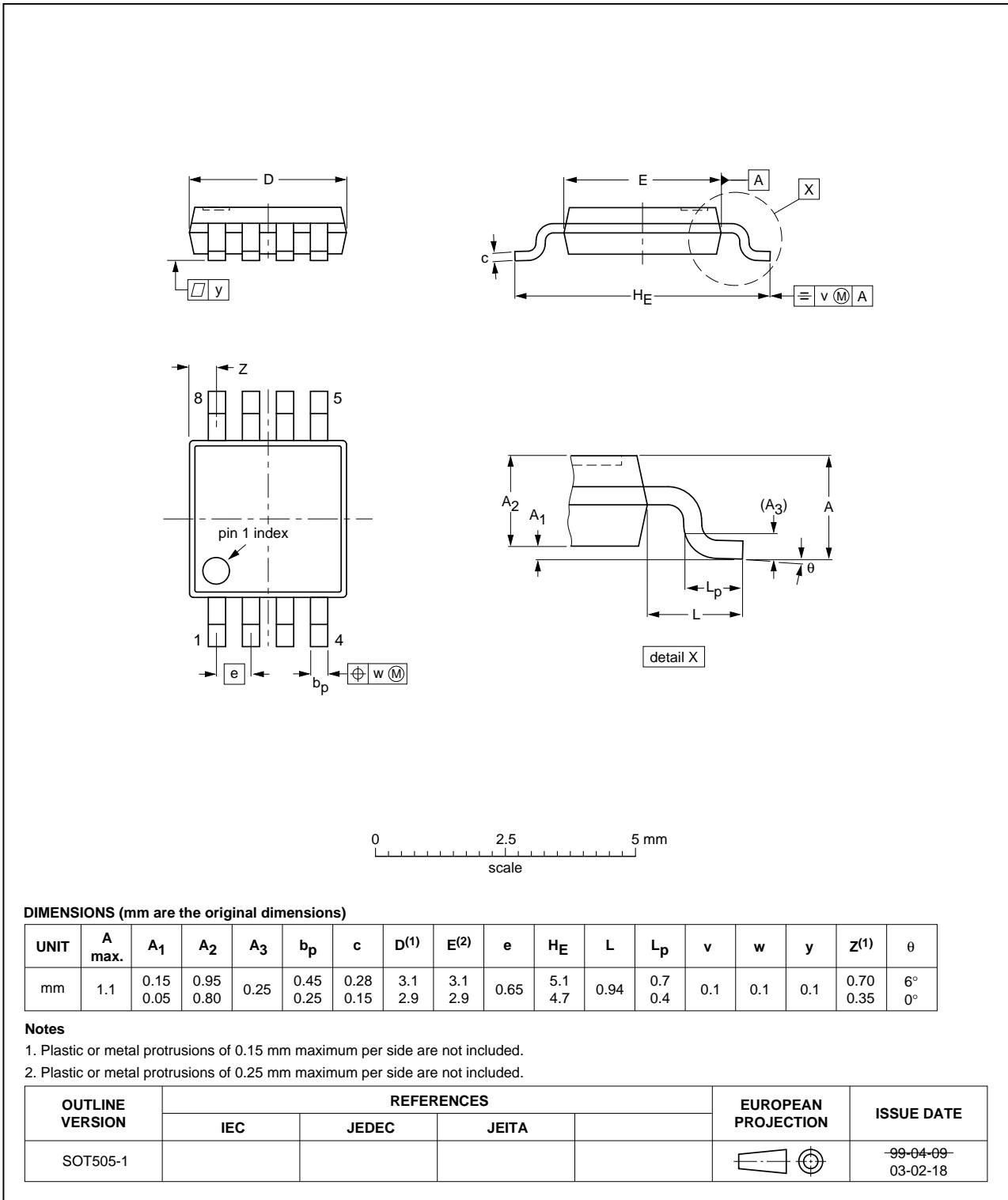

Fig 22. Package outline SOT505-1 (TSSOP8)

HVSON8: plastic thermal enhanced very thin small outline package; no leads;
8 terminals; body 3 x 3 x 0.85 mm

SOT782-1

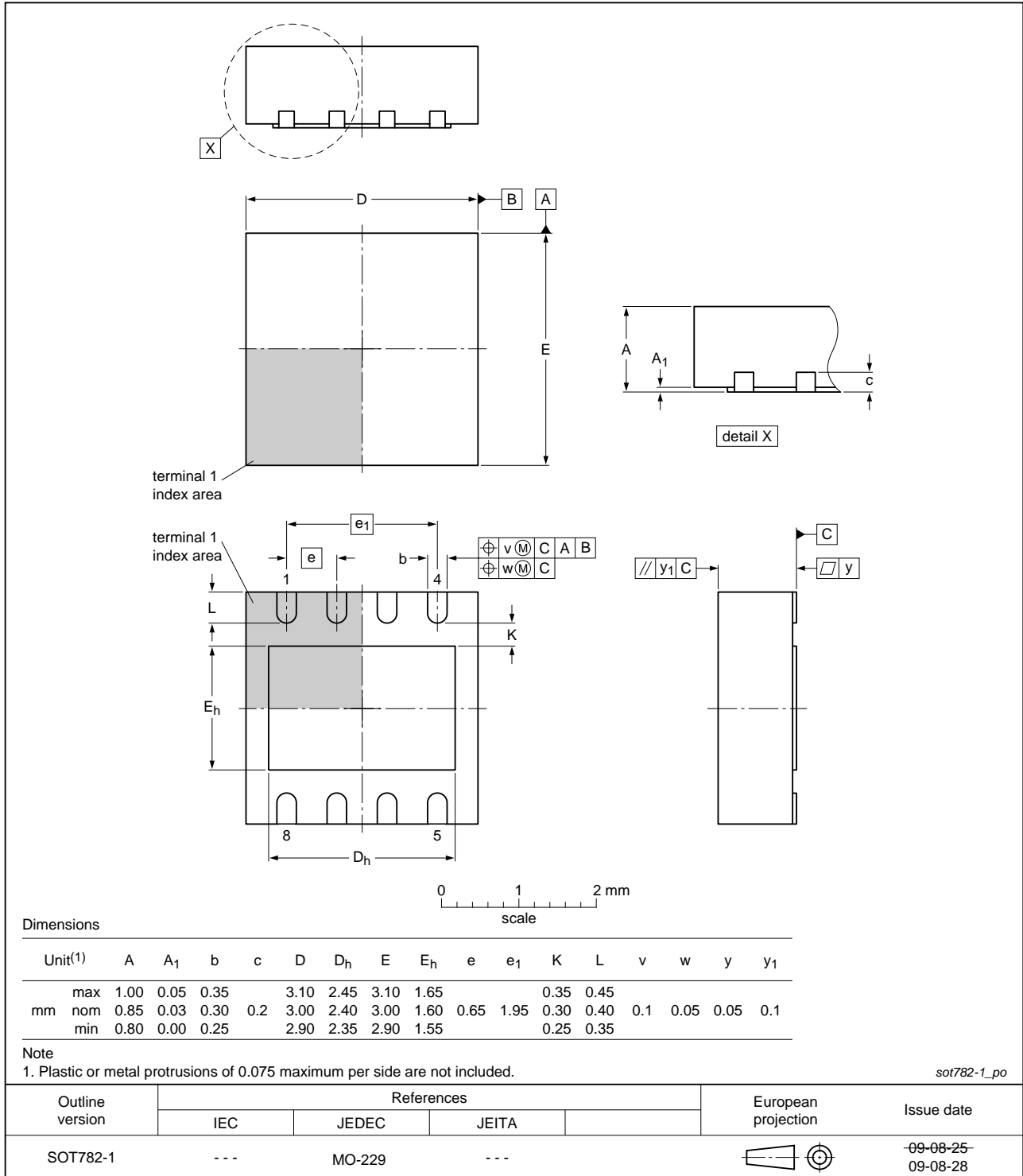

Fig 23. Package outline SOT782-1 (HVSON8)

13. Soldering of SMD packages

This text provides a very brief insight into a complex technology. A more in-depth account of soldering ICs can be found in Application Note *AN10365 "Surface mount reflow soldering description"*.

13.1 Introduction to soldering

Soldering is one of the most common methods through which packages are attached to Printed Circuit Boards (PCBs), to form electrical circuits. The soldered joint provides both the mechanical and the electrical connection. There is no single soldering method that is ideal for all IC packages. Wave soldering is often preferred when through-hole and Surface Mount Devices (SMDs) are mixed on one printed wiring board; however, it is not suitable for fine pitch SMDs. Reflow soldering is ideal for the small pitches and high densities that come with increased miniaturization.

13.2 Wave and reflow soldering

Wave soldering is a joining technology in which the joints are made by solder coming from a standing wave of liquid solder. The wave soldering process is suitable for the following:

- Through-hole components
- Leaded or leadless SMDs, which are glued to the surface of the printed circuit board

Not all SMDs can be wave soldered. Packages with solder balls, and some leadless packages which have solder lands underneath the body, cannot be wave soldered. Also, leaded SMDs with leads having a pitch smaller than ~0.6 mm cannot be wave soldered, due to an increased probability of bridging.

The reflow soldering process involves applying solder paste to a board, followed by component placement and exposure to a temperature profile. Leaded packages, packages with solder balls, and leadless packages are all reflow solderable.

Key characteristics in both wave and reflow soldering are:

- Board specifications, including the board finish, solder masks and vias
- Package footprints, including solder thieves and orientation
- The moisture sensitivity level of the packages
- Package placement
- Inspection and repair
- Lead-free soldering versus SnPb soldering

13.3 Wave soldering

Key characteristics in wave soldering are:

- Process issues, such as application of adhesive and flux, clinching of leads, board transport, the solder wave parameters, and the time during which components are exposed to the wave
- Solder bath specifications, including temperature and impurities

13.4 Reflow soldering

Key characteristics in reflow soldering are:

- Lead-free versus SnPb soldering; note that a lead-free reflow process usually leads to higher minimum peak temperatures (see [Figure 24](#)) than a SnPb process, thus reducing the process window
- Solder paste printing issues including smearing, release, and adjusting the process window for a mix of large and small components on one board
- Reflow temperature profile; this profile includes preheat, reflow (in which the board is heated to the peak temperature) and cooling down. It is imperative that the peak temperature is high enough for the solder to make reliable solder joints (a solder paste characteristic). In addition, the peak temperature must be low enough that the packages and/or boards are not damaged. The peak temperature of the package depends on package thickness and volume and is classified in accordance with [Table 22](#) and [23](#)

Table 22. SnPb eutectic process (from J-STD-020C)

Package thickness (mm)	Package reflow temperature (°C)	
	Volume (mm ³)	
	< 350	≥ 350
< 2.5	235	220
≥ 2.5	220	220

Table 23. Lead-free process (from J-STD-020C)

Package thickness (mm)	Package reflow temperature (°C)		
	Volume (mm ³)		
	< 350	350 to 2000	> 2000
< 1.6	260	260	260
1.6 to 2.5	260	250	245
> 2.5	250	245	245

Moisture sensitivity precautions, as indicated on the packing, must be respected at all times.

Studies have shown that small packages reach higher temperatures during reflow soldering, see [Figure 24](#).

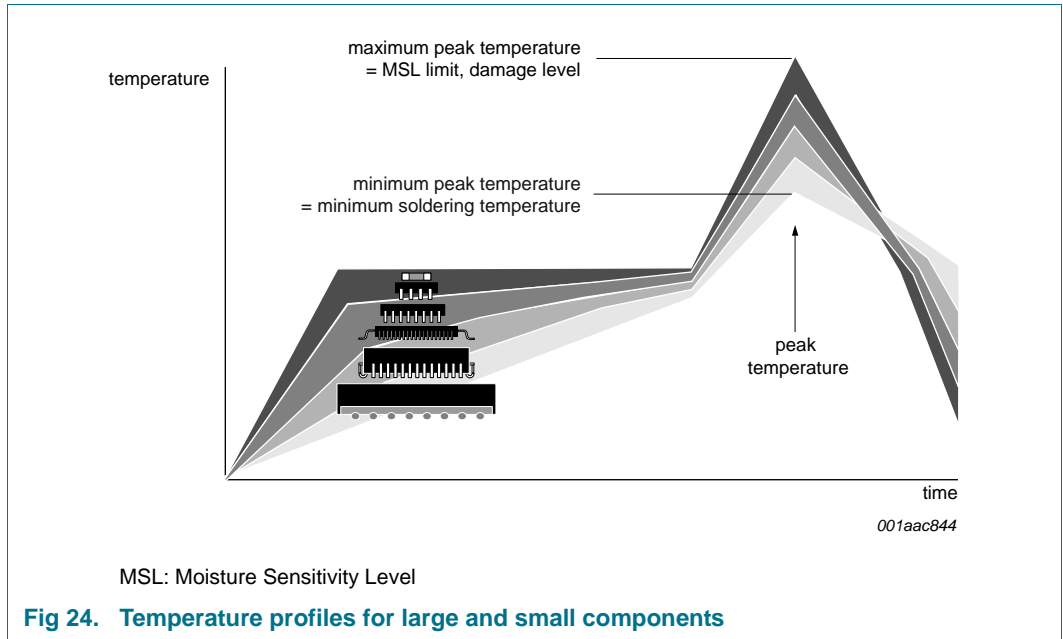

For further information on temperature profiles, refer to Application Note AN10365 "Surface mount reflow soldering description".

14. Soldering: PCB footprints

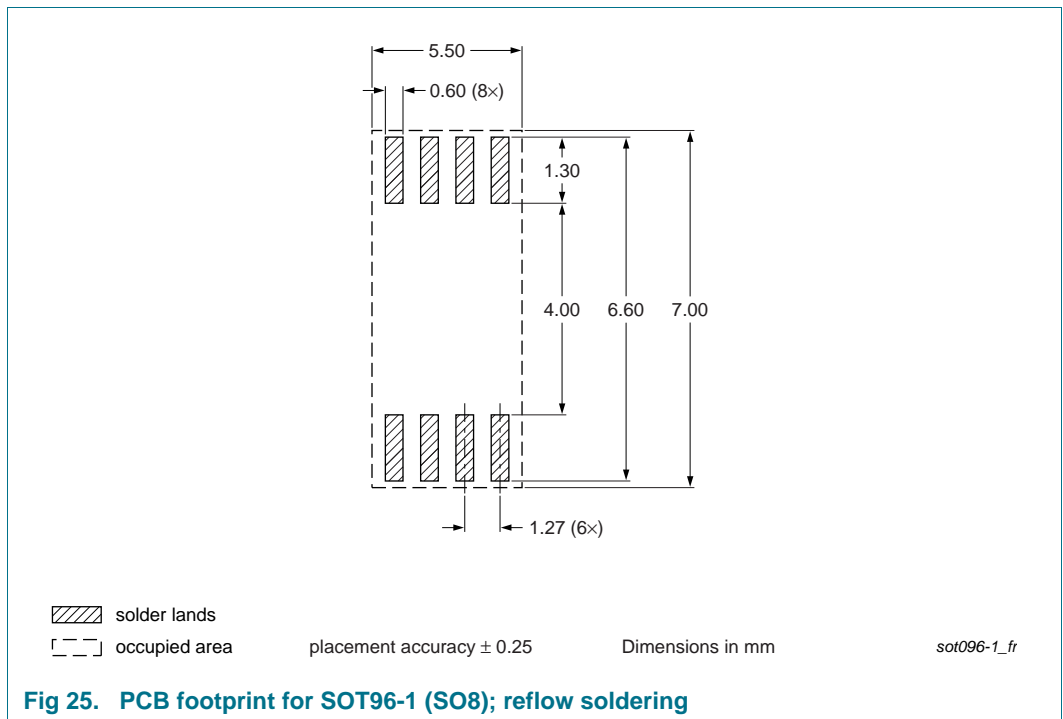

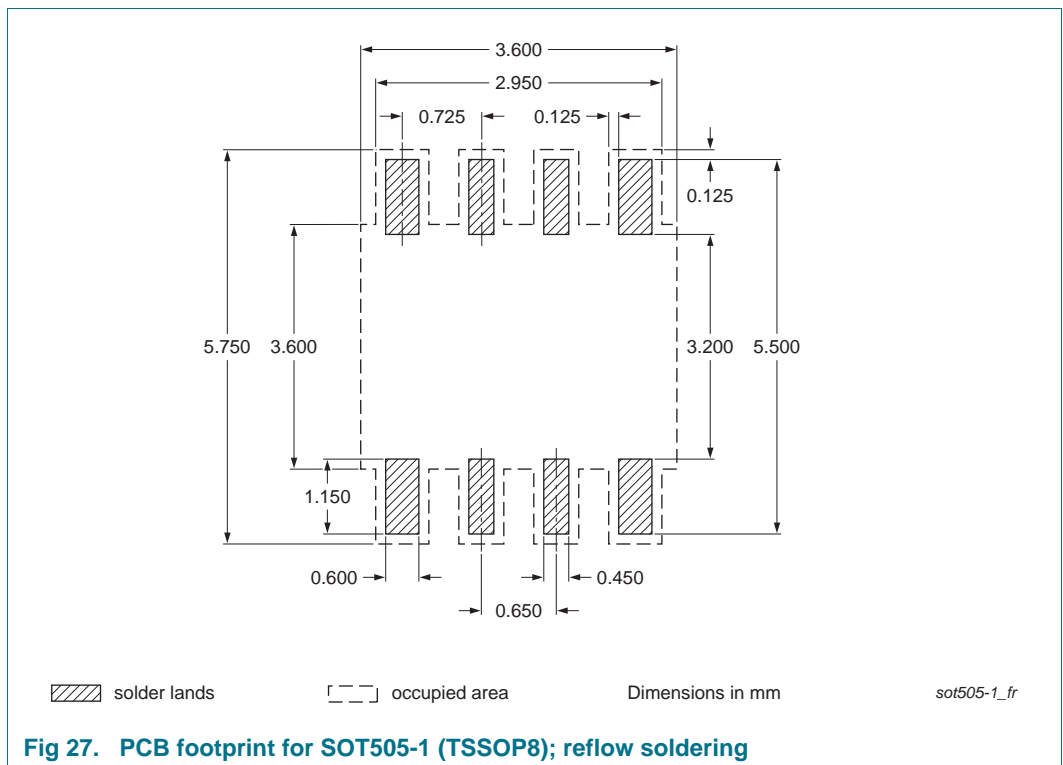

Footprint information for reflow soldering of HVSON8 package

SOT782-1



- solder land
- solder paste deposit
- solder land plus solder paste
- occupied area

DIMENSIONS in mm

P	Ay	By	C	D	SLx	SLy	SPx	SPy	Gx	Gy	Hy
0.65	3.25	2.2	0.525	0.3	2.45	1.65	1.1	0.65	3.25	3.25	3.5

nSPx	nSPy
1	1

Issue date 12-02-09
12-02-28

sot782-1_fr

Fig 28. PCB footprint for SOT782-1 (HVSON8); reflow soldering

15. Abbreviations

Table 24. Abbreviations

Acronym	Description
A/D	Analog-to-Digital
ARA	Alert Response Address
ASIC	Application Specific Integrated Circuit
CRT	Cathode Ray Tube
ESD	ElectroStatic Discharge
HBM	Human Body Model
HVAC	Heating, Ventilating and Air Conditioning
I ² C-bus	Inter-Integrated Circuit bus
LSB	Least Significant Bit
MSB	Most Significant Bit
OTP	One-Time Programmable
POR	Power-On Reset
PTAT	Proportional To Absolute Temperature
SMBus	System Management Bus
UVLO	Under Voltage LockOut

16. Revision history

Table 25. Revision history

Document ID	Release date	Data sheet status	Change notice	Supersedes
SA56004X v.7	20130225	Product data sheet	-	SA56004X v.6
Modifications:	<ul style="list-style-type: none"> • Table 1 "Ordering information": added "Topside marking" column and corrected Topside marking for SO8 package (appended "D") • Table 2 "Ordering options" modified: <ul style="list-style-type: none"> – deleted column "Topside marking" (moved to Table 1) – added columns "Orderable part number", "Package", "Packing method", "Minimum order quantity" • Section 7.2 "Slave address": added (new) Table 4 "Slave addresses" • Added (new) Section 8.3 "Timing and firmware consideration" • Deleted (old) Section 13 "Packing information" • Added (new) Section 14 "Soldering: PCB footprints" 			
SA56004X v.6	20120423	Product data sheet	-	SA56004X v.5
SA56004X v.5	20080522	Product data sheet	-	SA56004X v.4
SA56004X v.4	20060808	Product data sheet	-	SA56004X v.3
SA56004X v.3 (9397 750 13841)	20041006	Product data sheet	-	SA56004X v.2
SA56004X v.2 (9397 750 12015)	20030903	Objective data	-	SA56004-X v.1
SA56004-X v.1 (9397 750 10993)	20030819	Objective data	-	-

17. Legal information

17.1 Data sheet status

Document status ^{[1][2]}	Product status ^[3]	Definition
Objective [short] data sheet	Development	This document contains data from the objective specification for product development.
Preliminary [short] data sheet	Qualification	This document contains data from the preliminary specification.
Product [short] data sheet	Production	This document contains the product specification.

[1] Please consult the most recently issued document before initiating or completing a design.

[2] The term 'short data sheet' is explained in section "Definitions".

[3] The product status of device(s) described in this document may have changed since this document was published and may differ in case of multiple devices. The latest product status information is available on the Internet at URL <http://www.nxp.com>.

17.2 Definitions

Draft — The document is a draft version only. The content is still under internal review and subject to formal approval, which may result in modifications or additions. NXP Semiconductors does not give any representations or warranties as to the accuracy or completeness of information included herein and shall have no liability for the consequences of use of such information.

Short data sheet — A short data sheet is an extract from a full data sheet with the same product type number(s) and title. A short data sheet is intended for quick reference only and should not be relied upon to contain detailed and full information. For detailed and full information see the relevant full data sheet, which is available on request via the local NXP Semiconductors sales office. In case of any inconsistency or conflict with the short data sheet, the full data sheet shall prevail.

Product specification — The information and data provided in a Product data sheet shall define the specification of the product as agreed between NXP Semiconductors and its customer, unless NXP Semiconductors and customer have explicitly agreed otherwise in writing. In no event however, shall an agreement be valid in which the NXP Semiconductors product is deemed to offer functions and qualities beyond those described in the Product data sheet.

17.3 Disclaimers

Limited warranty and liability — Information in this document is believed to be accurate and reliable. However, NXP Semiconductors does not give any representations or warranties, expressed or implied, as to the accuracy or completeness of such information and shall have no liability for the consequences of use of such information. NXP Semiconductors takes no responsibility for the content in this document if provided by an information source outside of NXP Semiconductors.

In no event shall NXP Semiconductors be liable for any indirect, incidental, punitive, special or consequential damages (including - without limitation - lost profits, lost savings, business interruption, costs related to the removal or replacement of any products or rework charges) whether or not such damages are based on tort (including negligence), warranty, breach of contract or any other legal theory.

Notwithstanding any damages that customer might incur for any reason whatsoever, NXP Semiconductors' aggregate and cumulative liability towards customer for the products described herein shall be limited in accordance with the *Terms and conditions of commercial sale* of NXP Semiconductors.

Right to make changes — NXP Semiconductors reserves the right to make changes to information published in this document, including without limitation specifications and product descriptions, at any time and without notice. This document supersedes and replaces all information supplied prior to the publication hereof.

Suitability for use — NXP Semiconductors products are not designed, authorized or warranted to be suitable for use in life support, life-critical or safety-critical systems or equipment, nor in applications where failure or malfunction of an NXP Semiconductors product can reasonably be expected to result in personal injury, death or severe property or environmental damage. NXP Semiconductors and its suppliers accept no liability for inclusion and/or use of NXP Semiconductors products in such equipment or applications and therefore such inclusion and/or use is at the customer's own risk.

Applications — Applications that are described herein for any of these products are for illustrative purposes only. NXP Semiconductors makes no representation or warranty that such applications will be suitable for the specified use without further testing or modification.

Customers are responsible for the design and operation of their applications and products using NXP Semiconductors products, and NXP Semiconductors accepts no liability for any assistance with applications or customer product design. It is customer's sole responsibility to determine whether the NXP Semiconductors product is suitable and fit for the customer's applications and products planned, as well as for the planned application and use of customer's third party customer(s). Customers should provide appropriate design and operating safeguards to minimize the risks associated with their applications and products.

NXP Semiconductors does not accept any liability related to any default, damage, costs or problem which is based on any weakness or default in the customer's applications or products, or the application or use by customer's third party customer(s). Customer is responsible for doing all necessary testing for the customer's applications and products using NXP Semiconductors products in order to avoid a default of the applications and the products or of the application or use by customer's third party customer(s). NXP does not accept any liability in this respect.

Limiting values — Stress above one or more limiting values (as defined in the Absolute Maximum Ratings System of IEC 60134) will cause permanent damage to the device. Limiting values are stress ratings only and (proper) operation of the device at these or any other conditions above those given in the Recommended operating conditions section (if present) or the Characteristics sections of this document is not warranted. Constant or repeated exposure to limiting values will permanently and irreversibly affect the quality and reliability of the device.

Terms and conditions of commercial sale — NXP Semiconductors products are sold subject to the general terms and conditions of commercial sale, as published at <http://www.nxp.com/profile/terms>, unless otherwise agreed in a valid written individual agreement. In case an individual agreement is concluded only the terms and conditions of the respective agreement shall apply. NXP Semiconductors hereby expressly objects to applying the customer's general terms and conditions with regard to the purchase of NXP Semiconductors products by customer.

No offer to sell or license — Nothing in this document may be interpreted or construed as an offer to sell products that is open for acceptance or the grant, conveyance or implication of any license under any copyrights, patents or other industrial or intellectual property rights.

Export control — This document as well as the item(s) described herein may be subject to export control regulations. Export might require a prior authorization from competent authorities.

Non-automotive qualified products — Unless this data sheet expressly states that this specific NXP Semiconductors product is automotive qualified, the product is not suitable for automotive use. It is neither qualified nor tested in accordance with automotive testing or application requirements. NXP Semiconductors accepts no liability for inclusion and/or use of non-automotive qualified products in automotive equipment or applications.

In the event that customer uses the product for design-in and use in automotive applications to automotive specifications and standards, customer (a) shall use the product without NXP Semiconductors' warranty of the product for such automotive applications, use and specifications, and (b) whenever customer uses the product for automotive applications beyond NXP Semiconductors' specifications such use shall be solely at customer's

own risk, and (c) customer fully indemnifies NXP Semiconductors for any liability, damages or failed product claims resulting from customer design and use of the product for automotive applications beyond NXP Semiconductors' standard warranty and NXP Semiconductors' product specifications.

Translations — A non-English (translated) version of a document is for reference only. The English version shall prevail in case of any discrepancy between the translated and English versions.

17.4 Trademarks

Notice: All referenced brands, product names, service names and trademarks are the property of their respective owners.

I²C-bus — logo is a trademark of NXP B.V.

18. Contact information

For more information, please visit: <http://www.nxp.com>

For sales office addresses, please send an email to: salesaddresses@nxp.com

19. Contents

1	General description	1	8.2.1	Power supply slew rate	25
2	Features and benefits	1	8.2.2	Application circuit	25
3	Applications	2	8.3	Timing and firmware consideration	25
4	Ordering information	2	9	Limiting values	26
4.1	Ordering options	3	10	Characteristics	27
5	Block diagram	4	11	Performance curves	30
6	Pinning information	5	12	Package outline	32
6.1	Pinning	5	13	Soldering of SMD packages	35
6.2	Pin description	5	13.1	Introduction to soldering	35
7	Functional description	6	13.2	Wave and reflow soldering	35
7.1	Serial bus interface	6	13.3	Wave soldering	35
7.2	Slave address	6	13.4	Reflow soldering	36
7.3	Register overview	7	14	Soldering: PCB footprints	37
7.4	Power-on reset	8	15	Abbreviations	40
7.5	Starting conversion	9	16	Revision history	40
7.6	Low power software standby mode	9	17	Legal information	41
7.7	Temperature data format	9	17.1	Data sheet status	41
7.8	SA56004X SMBus registers	10	17.2	Definitions	41
7.8.1	Command register	10	17.3	Disclaimers	41
7.8.2	Local and remote temperature registers (LTHB, LTLB, RTHB, RTLB)	10	17.4	Trademarks	42
7.8.3	Configuration register (CON)	10	18	Contact information	42
7.8.4	Status register (SR)	11	19	Contents	43
7.8.5	Conversion rate register (CR)	12			
7.8.6	Temperature limit registers	12			
7.8.7	Programmable offset register (remote only)	13			
7.8.8	ALERT mode register (AM)	13			
7.8.9	Other registers	13			
7.8.10	One-shot register	13			
7.9	Interrupt logic and functional description	14			
7.9.1	ALERT output	14			
7.9.1.1	ALERT output in comparator mode	14			
7.9.1.2	ALERT output in interrupt mode	14			
7.9.1.3	ALERT output in SMBus ALERT mode	15			
7.9.2	T_CRIT output	17			
7.9.3	Fault Queue	18			
7.9.4	Temperature measurement	19			
7.9.5	Diode fault detection	19			
7.10	SMBus interface	20			
7.10.1	Serial interface reset	22			
8	Application design-in information	22			
8.1	Factors affecting accuracy	22			
8.1.1	Remote sensing diode	22			
8.1.2	Thermal inertia and self-heating	23			
8.1.3	Layout considerations	24			
8.2	Power sequencing considerations	25			

Please be aware that important notices concerning this document and the product(s) described herein, have been included in section 'Legal information'.

© NXP B.V. 2013.

All rights reserved.

For more information, please visit: <http://www.nxp.com>

For sales office addresses, please send an email to: salesaddresses@nxp.com

Date of release: 25 February 2013

Document identifier: SA56004X

Компания «Океан Электроники» предлагает заключение долгосрочных отношений при поставках импортных электронных компонентов на взаимовыгодных условиях!

Наши преимущества:

- Поставка оригинальных импортных электронных компонентов напрямую с производств Америки, Европы и Азии, а так же с крупнейших складов мира;
- Широкая линейка поставок активных и пассивных импортных электронных компонентов (более 30 млн. наименований);
- Поставка сложных, дефицитных, либо снятых с производства позиций;
- Оперативные сроки поставки под заказ (от 5 рабочих дней);
- Экспресс доставка в любую точку России;
- Помощь Конструкторского Отдела и консультации квалифицированных инженеров;
- Техническая поддержка проекта, помощь в подборе аналогов, поставка прототипов;
- Поставка электронных компонентов под контролем ВП;
- Система менеджмента качества сертифицирована по Международному стандарту ISO 9001;
- При необходимости вся продукция военного и аэрокосмического назначения проходит испытания и сертификацию в лаборатории (по согласованию с заказчиком);
- Поставка специализированных компонентов военного и аэрокосмического уровня качества (Xilinx, Altera, Analog Devices, Intersil, Interpoint, Microsemi, Actel, Aeroflex, Peregrine, VPT, Syfer, Eurofarad, Texas Instruments, MS Kennedy, Miteq, Cobham, E2V, MA-COM, Hittite, Mini-Circuits, General Dynamics и др.);

Компания «Океан Электроники» является официальным дистрибьютором и эксклюзивным представителем в России одного из крупнейших производителей разъемов военного и аэрокосмического назначения «JONHON», а так же официальным дистрибьютором и эксклюзивным представителем в России производителя высокотехнологичных и надежных решений для передачи СВЧ сигналов «FORSTAR».



JONHON

«JONHON» (основан в 1970 г.)

Разъемы специального, военного и аэрокосмического назначения:

(Применяются в военной, авиационной, аэрокосмической, морской, железнодорожной, горно- и нефтедобывающей отраслях промышленности)

«FORSTAR» (основан в 1998 г.)

ВЧ соединители, коаксиальные кабели,
кабельные сборки и микроволновые компоненты:

(Применяются в телекоммуникациях гражданского и специального назначения, в средствах связи, РЛС, а так же военной, авиационной и аэрокосмической отраслях промышленности).



Телефон: 8 (812) 309-75-97 (многоканальный)

Факс: 8 (812) 320-03-32

Электронная почта: ocean@oceanchips.ru

Web: <http://oceanchips.ru/>

Адрес: 198099, г. Санкт-Петербург, ул. Калинина, д. 2, корп. 4, лит. А