

1. Introduction

Miniaturization and a low profile are demanded of the semiconductors and electronic components used in portable devices such as smartphones and tablets. Accompanying the lower voltages and larger currents used in semiconductors in devices, DC/DC converters, which have a higher conversion efficiency than linear regulators, are seeing increasing use.

DC/DC converters normally include a power control IC, coil, capacitor, and resistor. For this reason, more mounting space is needed than a linear regulator, which contributes to increased board cost. In addition, inappropriate selection of components and board layout may lead to circuit malfunctioning and noise problems. As a solution to these issues, micro DC/DC converters are gaining increasing attention. Micro DC/DC converters have a small number of components, and thus the board layout is simple and little noise occurs, which helps reduce development time.

This document introduces micro DC/DC converter products and provides points for effective use.

2. Structures and Features of micro DC/DC Converters

TOREX micro DC/DC converter products are centered on a switching regulator with a single output that integrates the control IC and coil. The package structure is determined by consideration of the product specifications, IC, coil, heat generation (heat dissipation), and other characteristics. Each package structure has advantages and disadvantages (Table 1).

Table 1: Structure and Features of Micro DC/DC Converters

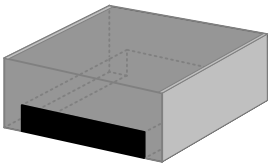
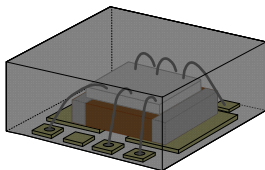
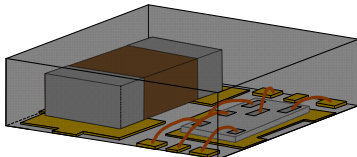
Structure number	TYPE - 1	TYPE - 2	TYPE - 3
Drawing			
Description	The IC is covered by the coil	The IC is stacked on the coil	The IC and coil are placed side-by-side
Features *	<ul style="list-style-type: none"> ◎ Radiated noise ◎ Near magnetics field △ Cost ◎ Mounting area ○ Large current ○ Heat dissipation 	<ul style="list-style-type: none"> ○ Radiated noise △ Near magnetics field ◎ Cost ○ Mounting area △ Large current △ Heat dissipation 	<ul style="list-style-type: none"> ○ Radiated noise ○ Near magnetics field ○ Cost △ Mounting area ◎ Large current ◎ Heat dissipation
Products	XCL101 (step-up) XCL201/XCL202 (step-down) XCL205/XCL206/XCL207 (step-down)	XCL208/XCL209 (step-down)	XCL211/XCL212 (step-down) XCL213/XCL214 (step-down)

* ◎ Best, ○ Better, △ Good

2.1 TYPE -1 Structure

The coil lies flat on the IC package. This shortens the path of the switching current and minimizes noise.

2.2 TYPE - 2 Structure

The resin mold mounts the IC chip on top of the coil. Relatively inexpensive because a coil with a generic shape can be used.

2.3 TYPE - 3 Structure

The coil and IC chip are placed side-by-side in the resin mold. The IC and coil have good heat dissipation, so large currents can be used.

3. Designed for Noise Reduction

In order to obtain full performance from electronic components, “whether or not the design achieves noise reduction” is an important concern from the stage of circuit design. However, even though the power circuit is a source of noise, component selection comes last. No matter how high the performance of the ICs and LSIs that are used, it will not be possible to obtain good performance from these components if the power circuit design is bad. In order to reduce noise in TOREX micro DC/DC converters, a variety of measures are taken, including:

- Using a coil with minimal flux leakage
- Adjustment of coil characteristics for the micro DC/DC
- Optimization of DC/DC operation
- Deciding pin assignments and structure based on consideration of the current path

Using measurements of radiated noise and near magnetics field strength, the following section describes the extent to which noise characteristics actually differ in “a power circuit composed of discrete components (XC9236)” and in “a micro DC/DC converter (XCL206)”.

3.1 EMI (Electromagnetic Interference)

Fig. 1 shows a comparison of radiated noise in two products, the “XC9236B18DMR-G” and the “XCL206B183AR-G”. The XC9236 (black waveform) generates noise over a wide range from 50M to 300MHz. By contrast, the XCL206 (yellowish green waveform) has a very low noise level. Even at the same operating frequency, the difference is clear. For this reason, the XCL206 (micro DC/DC converter) does not require full implementation of the noise measures that always tend to be put off until later. And on the XCL202 (Freq = 1.2MHz), which has the same structure as the XCL206, the operating frequency is reduced for even lower noise (refer to the EMI data).

Testing conditions : $V_{IN}=3.7V$ (DC power supply), $V_{OUT}=1.8V$, $I_{OUT}=200mA$ (resistor : 9Ω)
 XC9236B18DMR(Freq=3MHz) $C_{in}=4.7\mu F, C_L=10\mu F$
 XCL206B183AR(Freq=3MHz) $C_{in}=4.7\mu F, C_L=10\mu F$

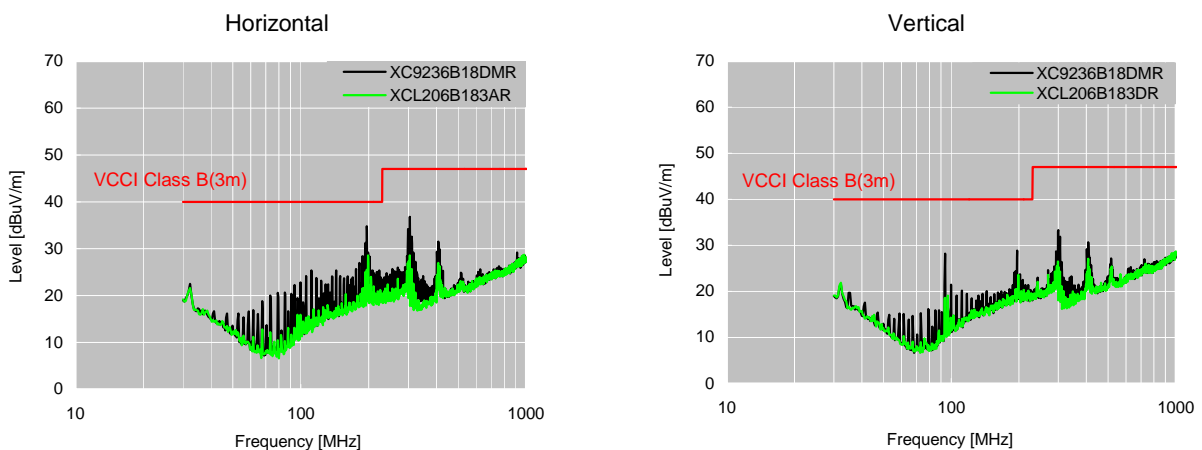

Fig. 1: Radiated Noise, XC9236B18DMR-G vs. XCL206B183AR-G

3.2 Near Magnetics Field Strength

Figure 2 shows a comparison of the near magnetics field strength of the “XC9236B18DMR-G” and the “XCL206B183AR-G”. The near magnetics field strength does not always correlate directly to the strength of unwanted radiated noise, however, it provides an effective means of identifying noise sources due to high-frequency current flowing in the board.

Testing conditions : $V_{IN}=3.7V$ (DC power supply), $V_{OUT}=1.8V$, $I_{OUT}=200mA$ (resistor : 9Ω)

XC9236B18DMR(Freq=3MHz) $C_{in}=4.7\mu F, C_L=10\mu F$

XCL206B183AR(Freq=3MHz) $C_{in}=4.7\mu F, C_L=10\mu F$

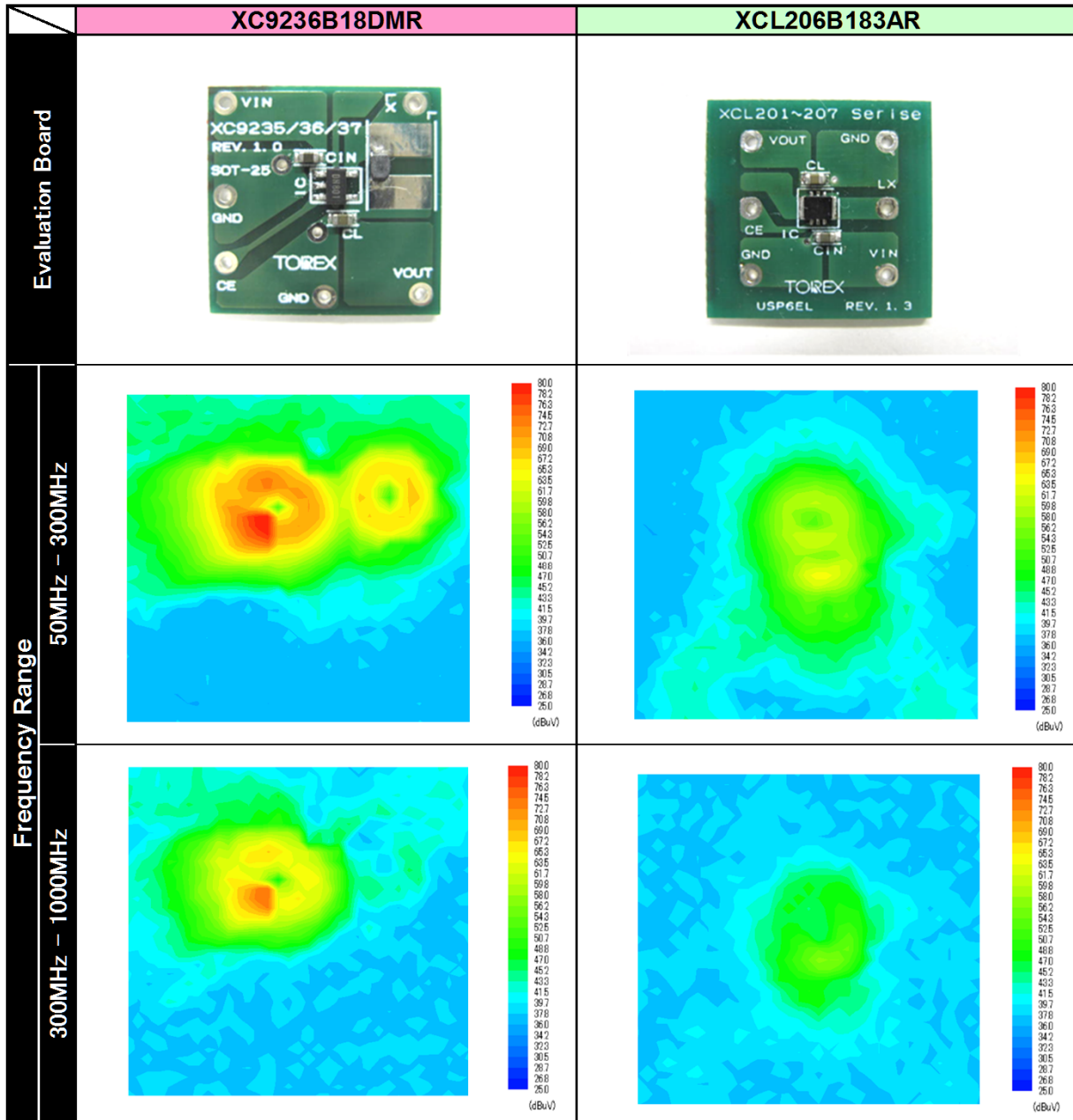

Fig. 2: Near Magnetics Field Strength, XC9236B18DMR-G vs. XCL206B183AR-G

At a frequency range of 50M to 300MHz, orange and red appear in a ring-like shape around the XC9236 IC. It can be seen that the strongest noise occurs in the vicinity of the IC’s GND pin. Yellow ring-shaped noise can also be seen at the coil. The coil is a simple shield type (ferrite powder mixed in the resin), and thus it is likely that the noise is due to flux leakage. By contrast, the XCL206 (micro DC/DC converter) has no red or orange, and little noise is generated.

4. Using Micro DC/DC Converters Effectively

A micro DC/DC converter can be operated without detailed knowledge. A basic knowledge is sufficient to reduce noise and heat generation in circuit components, increase component reliability, and improve product acclaim.

4.1 Compact and Low Profile

A micro DC/DC converter requires only half the mounting space of a regular DC/DC converter consisting of discrete components, and thus also helps save board cost. The same board space as a linear regulator is sufficient.

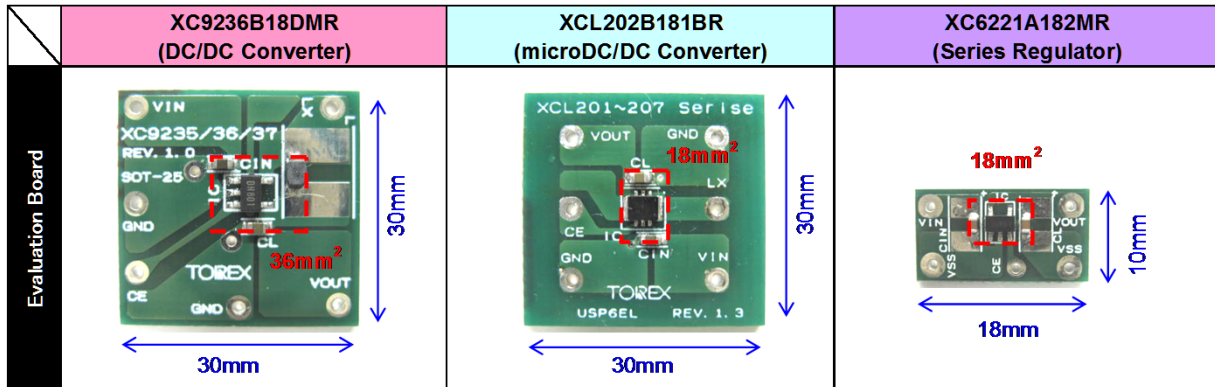

Fig. 3: Comparison of Mounting Space

4.2 Efficiency and Component Temperature

There is a large difference in power conversion efficiency between linear regulators and micro DC/DC converters (Fig. 4).

Example) XC6221 ···· 48% (@I_{OUT} = 100mA)
 XCL202 ···· 87% (@I_{OUT} = 100mA)

This difference in efficiency creates a big difference in device battery drive time. The efficiency difference is loss due to conversion to IC heat (Fig. 5).

XC6221(PKG:SOT-25)⇒61.3°C (@Ta=23.4°C)
 XCL202(PKG:CL-2025)⇒36.3°C (@Ta=23.4°C)

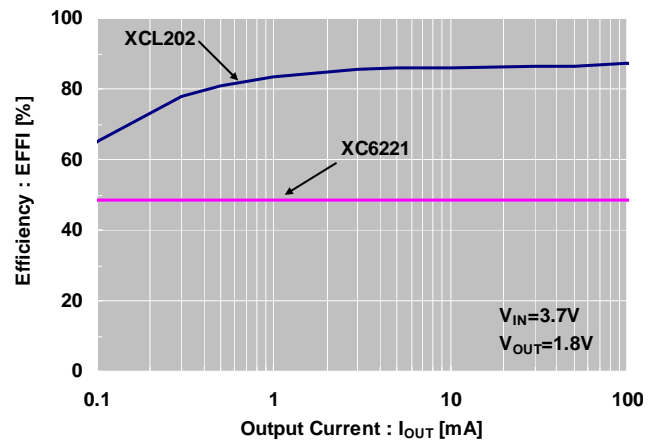

Fig. 4: Power Conversion Efficiency, XC6221A182MR-G vs. XCL202B181BR-G

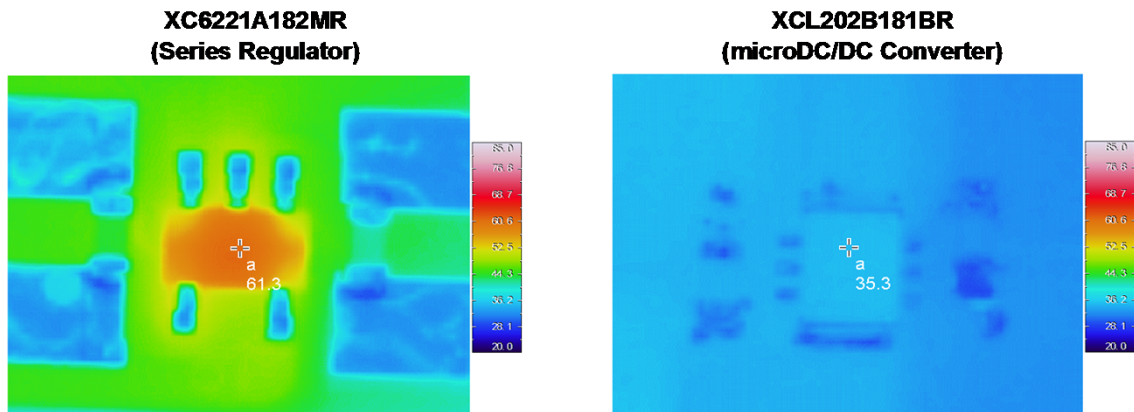

Fig. 5: Heat Characteristics, XC6221A182MR-G vs. XCL202B181BR-G

4.3 Board Layout Points

The GND wiring appears simple in the circuit diagram, however, in some cases the actual layout on the printed circuit board is very difficult. It is not a matter of simply making connections, because if the connection positions and board layout are bad, the performance of the entire system will be degraded. For example, a step-down DC/DC converter alternately switches switch 1 (SW1) and switch 2 (SW2) ON/OFF, controlling the currents in order to stabilize the output voltage. The currents that flow when this is done are Current (1) and Current (2) (refer to Fig. 6).

Current only flows in the red wiring shown in Fig. 7 when either Current (1) only or Current (2) only operates. When switch 1 (SW1) and switch 2 (SW2) are switched, the switching current is instantaneously interrupted, causing the L (inductance) component of the wiring to generate an electromotive force.

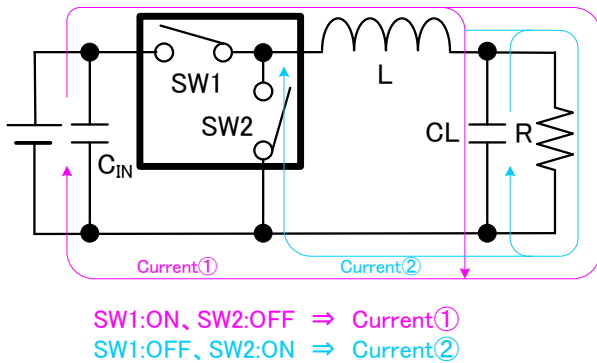

Fig. 6: Current Path of Step-Down DC/DC Converter

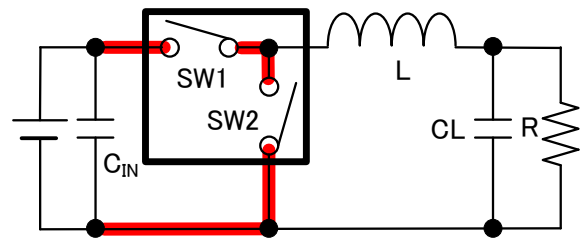

Fig. 7: Step-Down DC/DC Converter Noise

The detailed steps that must be taken are explained below using circuit diagrams.

To reduce noise, the red wiring in Fig. 7 must be kept short. Apart from the wiring inside the IC, the input capacitance (C_{IN}) should be placed near the V_{IN} - GND pins of the DC/DC converter and connected with short wiring (refer to Fig. 8). Caution is required because GND in particular will disperse noise throughout the entire system.

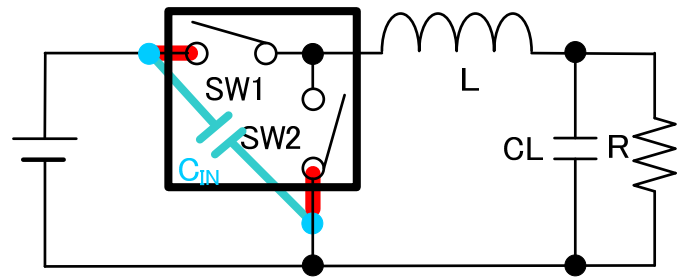

Fig. 8: C_{IN} Connection Location on Circuit Diagram

The next explanation refers to the actual test board of the XCL206 (micro DC/DC converter). There is a power GND (PGND) and an analog GND (AGND). In this case, the input capacitance (C_{IN}) can be connected by a short connection to the power GND (PGND) to make the area of the GND pattern (red) where the electromotive force generated is extremely small (Fig. 9).

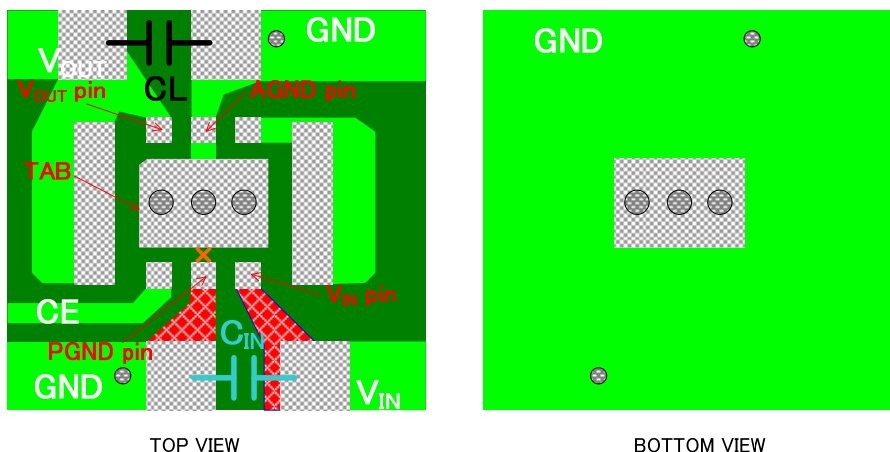
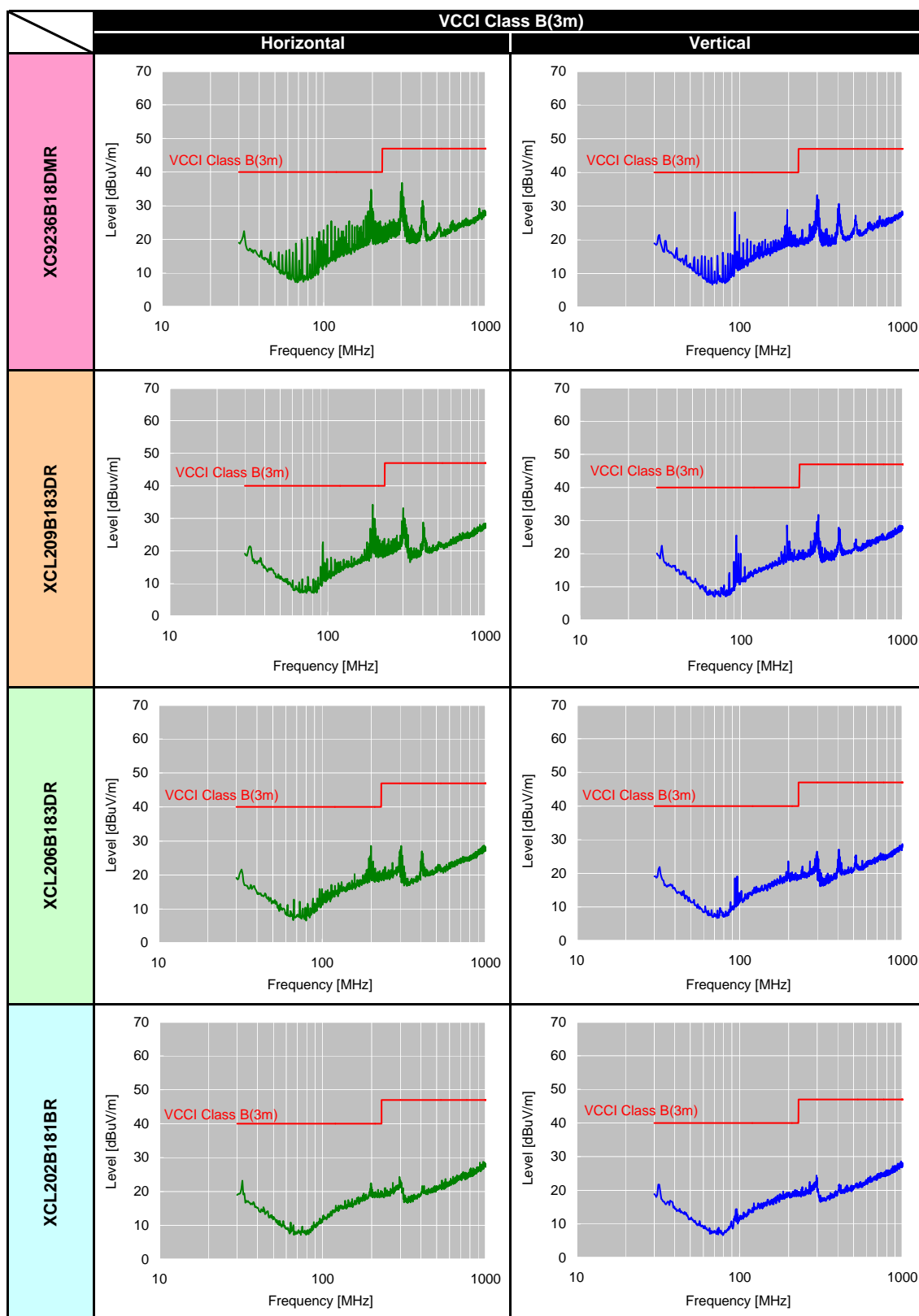

Fig. 9: XCL206 Printed Circuit Board Layout (TOP VIEW/BOTTOM VIEW)

5. Conclusion

Manufacturers inside and outside Japan have recently been aggressively pursuing the development of wearable devices. Starting several years ago, many TOIREX micro DC/DC converters have been adopted for use in GPS watches (sports watches), HMDs (Head Mounted Displays), pulse oximeters, and other devices. Wearable devices are worn for long periods of time, and as such their design reflects concern for preventing “burn injury due to component heat generation”, “battery drive time”, and “the effects of high frequency noise on the body.” This is a likely reason for the increased use of micro DC/DC converters with their compact size, high efficiency, and low noise among the manufacturers. Noise data (radiated noise, near magnetics field strength) are provided at the end of this document to serve as an aid in component selection.

<参考資料> EMI (Electromagnetic Interference) $V_{IN}=3.7V, V_{OUT}=1.8V/I_{OUT}=200mA$



<參考資料> 近傍磁界強度 (Near Magnetics Field) $V_{IN}=3.7V, V_{OUT}=1.8V/I_{OUT}=200mA$

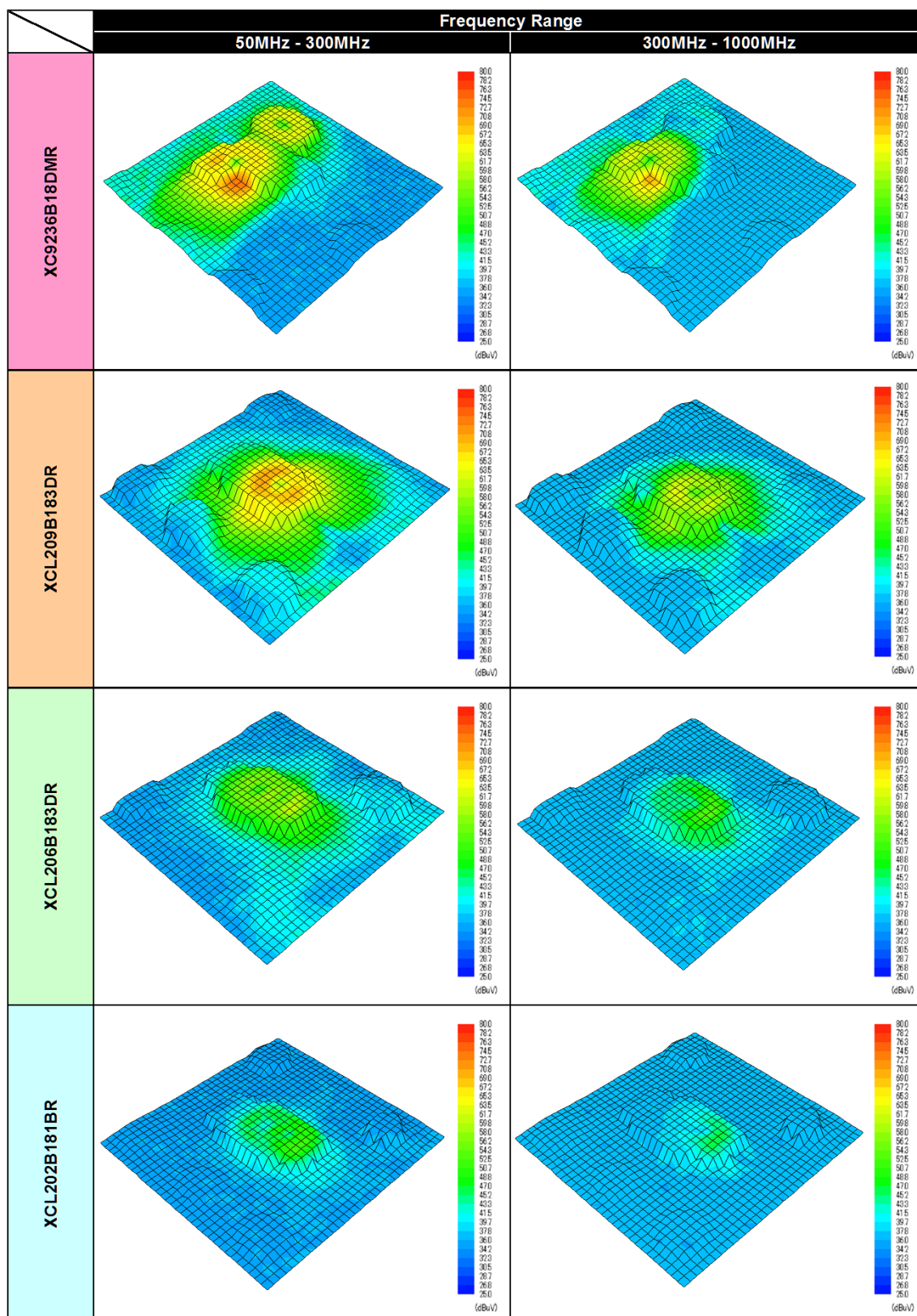

Компания «Океан Электроники» предлагает заключение долгосрочных отношений при поставках импортных электронных компонентов на взаимовыгодных условиях!

Наши преимущества:

- Поставка оригинальных импортных электронных компонентов напрямую с производств Америки, Европы и Азии, а так же с крупнейших складов мира;
- Широкая линейка поставок активных и пассивных импортных электронных компонентов (более 30 млн. наименований);
- Поставка сложных, дефицитных, либо снятых с производства позиций;
- Оперативные сроки поставки под заказ (от 5 рабочих дней);
- Экспресс доставка в любую точку России;
- Помощь Конструкторского Отдела и консультации квалифицированных инженеров;
- Техническая поддержка проекта, помощь в подборе аналогов, поставка прототипов;
- Поставка электронных компонентов под контролем ВП;
- Система менеджмента качества сертифицирована по Международному стандарту ISO 9001;
- При необходимости вся продукция военного и аэрокосмического назначения проходит испытания и сертификацию в лаборатории (по согласованию с заказчиком);
- Поставка специализированных компонентов военного и аэрокосмического уровня качества (Xilinx, Altera, Analog Devices, Intersil, Interpoint, Microsemi, Actel, Aeroflex, Peregrine, VPT, Syfer, Eurofarad, Texas Instruments, MS Kennedy, Miteq, Cobham, E2V, MA-COM, Hittite, Mini-Circuits, General Dynamics и др.);

Компания «Океан Электроники» является официальным дистрибьютором и эксклюзивным представителем в России одного из крупнейших производителей разъемов военного и аэрокосмического назначения «JONHON», а так же официальным дистрибьютором и эксклюзивным представителем в России производителя высокотехнологичных и надежных решений для передачи СВЧ сигналов «FORSTAR».



JONHON

«JONHON» (основан в 1970 г.)

Разъемы специального, военного и аэрокосмического назначения:

(Применяются в военной, авиационной, аэрокосмической, морской, железнодорожной, горно- и нефтедобывающей отраслях промышленности)

«FORSTAR» (основан в 1998 г.)

ВЧ соединители, коаксиальные кабели, кабельные сборки и микроволновые компоненты:

(Применяются в телекоммуникациях гражданского и специального назначения, в средствах связи, РЛС, а так же военной, авиационной и аэрокосмической отраслях промышленности).



Телефон: 8 (812) 309-75-97 (многоканальный)

Факс: 8 (812) 320-03-32

Электронная почта: ocean@oceanchips.ru

Web: <http://oceanchips.ru/>

Адрес: 198099, г. Санкт-Петербург, ул. Калинина, д. 2, корп. 4, лит. А