

FEATURES

- ◆ Wide input voltage range, 18~60V
- ◆ 200W Output @ 18V~27V Vin range
- ◆ 300W Output @ 27~60V Vin range (Including 27V)
- ◆ Full Load Efficiency up to 88.7% @48Vin
- ◆ Intergrated fuse holder (option)
- ◆ Parallel Connection of multiple units
- ◆ Box type package with metal base plate
- ◆ Package Dimension:
- ◆ 190.0x76.0x44.0mm (7.48"x2.99"x1.73")
- ◆ Operating Temperature Range - 40°C to +75°C
- ◆ Input Reverse Polarity Protection
- ◆ Minimized Inrush current
- ◆ Input UVLO, Output OCL, Short circuit protection, OVP, OTP
- ◆ Enable on/off (option)
- ◆ 2250VDC Isolation
- ◆ IP67 Protection
- ◆ RoHs Compliant
- ◆ ISO 9001, ISO 14001 certified manufacturing facility
- ◆ UL60950
- ◆ CE Mark
- ◆ EMC compatible: EN12895, CISPR11 ClassA
- ◆ Electrical transient conduction: ISO7637-2



The B40SR13722, a wide input voltage range of 18~60V, and single isolated output converter, is the latest product offering from a world leader in power systems technology and manufacturing — Delta Electronics, Inc. Such box type DCDC converter can provide 300W (200W at Vin < 27V), 13.7V regulated DC output voltage with full load efficiency up to 88.7% @48Vin; The B40SR13722 offers input UVLO, output over current limit, short circuit, output over voltage, over temperature, and input reverse polarity protections, It has an option for intergrated fuse holder and enable on/off function. It also has parallel function; and allows a wide operating temperature range of -40°C to +75°C. With creative design technology and optimization of component placement, this converter possess outstanding electrical and thermal performance, as well as high reliability under extrmely harsh operating conditions. The B40SR13722 meet IP67 protection(refer to “water protection level” specification).

Input Characteristics

Item	Condition	Min.	Typ.	Max.	Unit
Continuous Input Voltage		18	48	60	VDC
Max Input voltage	10 minutes, normal operating			80	VDC
Input Under-Voltage Lockout, Turn-On Voltage Threshold		16	17	18	VDC
Input Under-Voltage Lockout, Turn-Off Voltage Threshold		14	15	16	VDC
Lockout Hysteresis Voltage		1	2	3	VDC
Maximum Input Current	Vin=18V, 100% Load		13.2	14	A
No-Load Input Current	Vin=24V		90	120	mA
	Vin=48V		40	70	mA
Off converter input current	Vin=48V, enable off (C version)		8	15	mA
Reflected input ripple current	Vin=48V, Vpp			0.1	A
Max Reverse Polarity Input Voltage				60	VDC
Max Inrush current				10	A
Internal Input Fuse	Ø6.35mm*31.75mm	250V/30A Fast-acting fuse			



Output Characteristics

Item	Conditions	Min.	Typ.	Max.	Unit
Operating Output Current Range	Vin=18V~27V	0		14.5	A
	Vin=27V~60V(include 27V)	0		22	A
Output Voltage Set Point	Vin=24V,36V,48V, Io=0	13.9	14.1	14.3	V
	Vin=24V, Io=14.5A	13.6	13.8	14.0	V
	Vin=36V,48V, Io=22A	13.5	13.7	13.9	V
Output Voltage Ripple and Noise,	Vin=36V, 48V, Io=22A, peak to peak, 20MHz bandwidth		100	160	mV
	RMS		35	50	mV
	Vin=24V, Io=14.5A, peak to peak, 20MHz bandwidth		80	110	mV
	RMS		15	30	mV
Output Current Limit	Vin=24V	15.5	17.5	19.5	A
	Vin=36V, 48V	24.5	26.5	28.5	A
Current share accuracy	Vin=36V, 48V, 22A for each module		6	10	%
Start-up time(start _up time by Vin)	Vin=48V,full load (for A/B/C/D)		800	950	mS
Start-up time(start _up time by Enable)	Vin=48V,full load (for C)		400	600	mS
Rise time			130	160	mS
Output Voltage Protection		15	17	19	V
Output Voltage Current Transient, positive and negative voltage step	Vin=24V, 7A to 11A load dynamic, 0.1A/us slew rate		150	200	mV
	Vin=36V,48V, 11A to 16.5A load dynamic, 0.1A/us slew rate		130	200	mV
Maximum Output Capacitance	ESR>10mohm			5000	μF
Output overshoot				3	%
Efficiency @ 100% Load(14.5A)	Vin=24V	86.5	88.5		%
Efficiency @ 100% Load(22A)	Vin=36V	86.8	88.8		%
Efficiency @ 100% Load(22A)	Vin=48V	86.7	88.7		%
Efficiency @ 60% Load(8.7A)	Vin=24V	87.5	89.5		%
Efficiency @ 60% Load(13.2A)	Vin=36V	87.8	89.8		%
Efficiency @ 60% Load(13.2A)	Vin=48V	87.1	89.1		%

General Characteristics

Item	Conditions	Min.	Typ.	Max.	Unit
Isolation Voltage,	Input to Output, Input to Case			2250	VDC
	Output to Case			550	VDC
Isolation Resistance, Input to Output		10			MΩ
Isolation Capacitance, Input to Output			6000		pF
Switching Frequency			175		KHz
MTBF	Ta=25°C, 80%load		0.95		Mhours
Weight			900		g

Environmental Specifications

Parameter	Conditions	Min.	Typ.	Max.	Unit
Storage Temperature Range		-40		+125	°C
Operating Temperature Range	Ambient Temperature	-40		+75	°C
Over Temperature Protection	NTC Temperature		120		°C
Humidity (non condensing)				95	% rel. H
Water Protection Level	With connector&fuseholder for B Without connector&fuseholder for A/C/D		IP67		
Vibration	IEC 60068-2-6	10G/15~200HZ/3 PLANES			
Shock	IEC 60068-2-27	50G 3 PLANES			
Emission	EN12895	30-1000MHz 34-45dBuV/m			
Immunity	EN12895, EN61000-4-3	10V/m /27-1000MHz AM; 10V/m /900MHz PM			
ESD	EN12895, EN61000-4-2	Direct: ±2KV ±4KV; Air: ±2KV ±4KV ±8KV			

Notes

- Specifications typical at Ta=+25°C, nominal input voltage and rated full load output current unless otherwise noted.
- Specifications are subject to change without notice.

ELECTRICAL CURVES

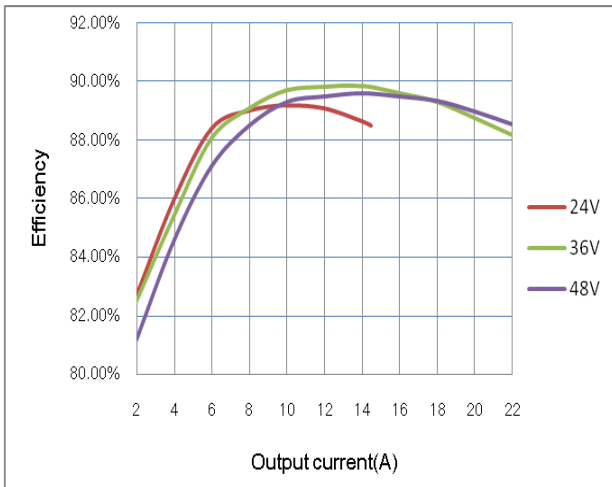

Figure 1: Efficiency vs. Output current
V_{in}=24V,36V,48V

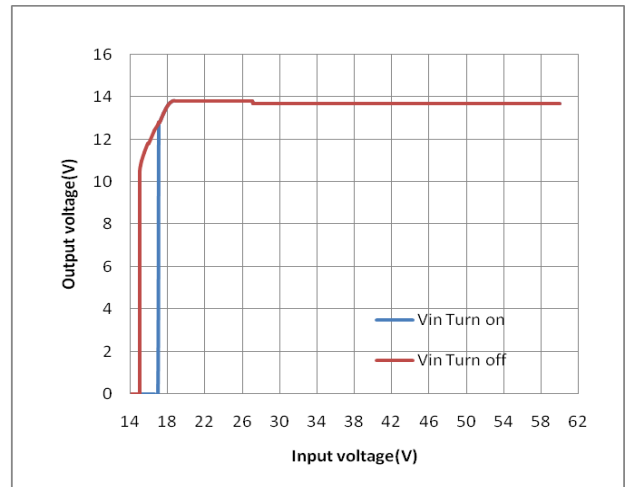

Figure 2: Output voltage vs. Input voltage
 @ *V_{in}*=18V~27V, 200W; *V_{in}*=27V~60V, 300W

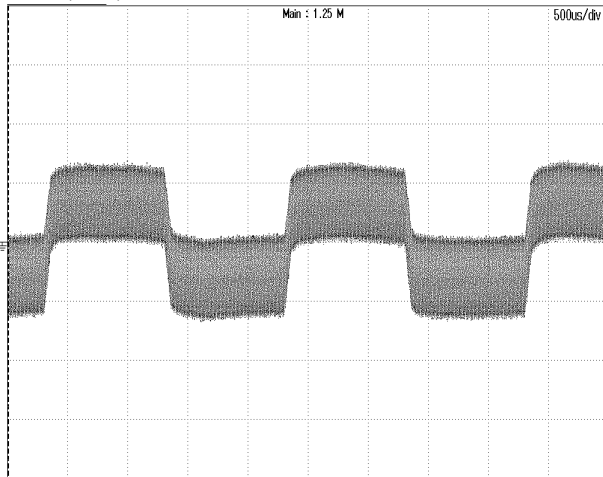

Figure 3: Dynamic response to load step 11A~16.5A with 0.1A/μs slew rate at 48V_{in}
 CH1: VOUT, 100mV/div, 500μs/div

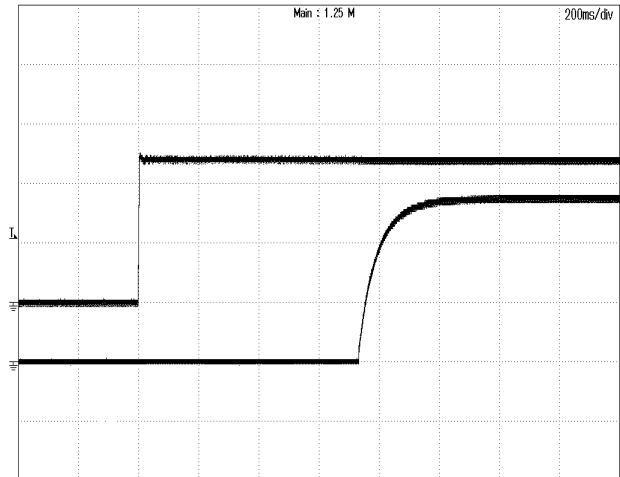

Figure 4: Vout start up with Vin on at 48V_{in}, 22A Iout,
 TOP: VIN, 20V/div, 200mS/div
 BOTTOM: VOUT, 5V/div, 200mS/div

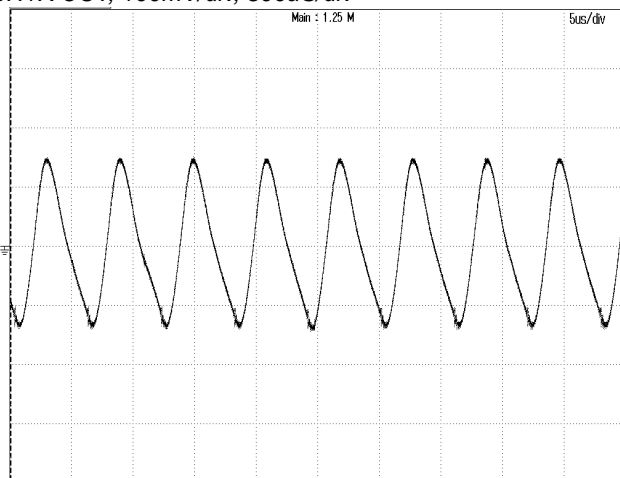

Figure 5: Output ripple & noise at 48V_{in}, 22A Iout
 CH1: VOUT, 50mV/div, 5uS/div



Figure 6: Output over voltage protection at 48V_{in}, 22A Iout
 CH1: VOUT, 10V/div, 100ms/div

ELECTRICAL CURVES (continuous)

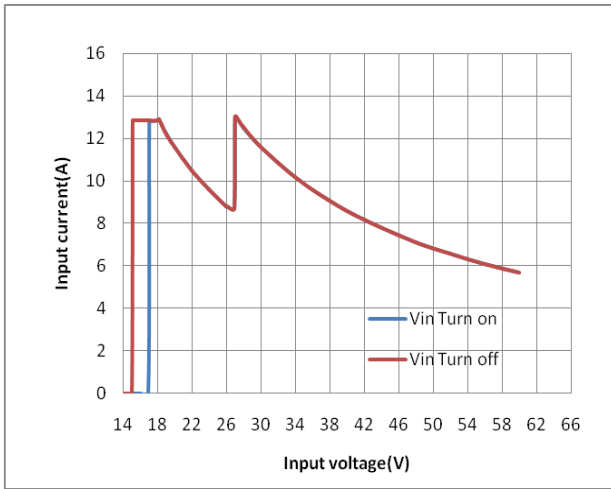

Figure 7: Input current vs. Input voltage
@ Vin=18V~27V, 200W; Vin=27V~60V, 300W

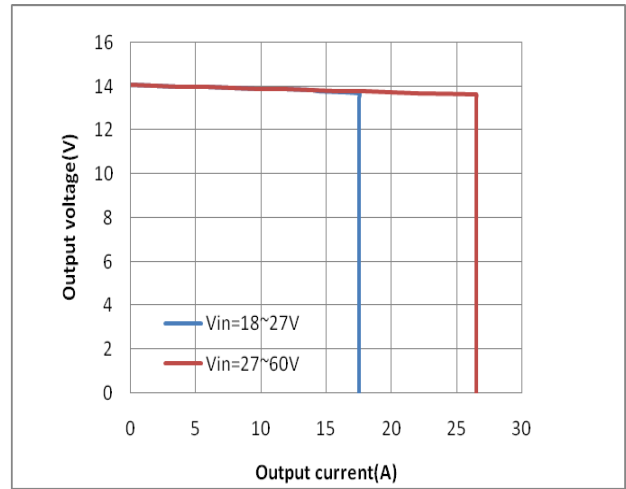

Figure 8: Output voltage vs. Output current
OCL Performance

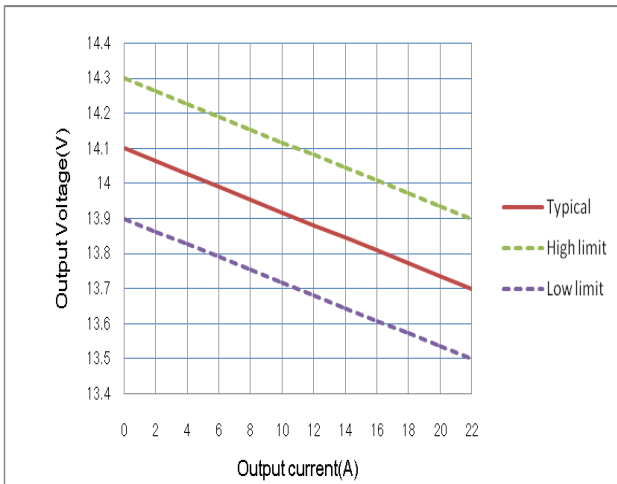

Figure 9: Output voltage vs. Output current
@ Vin=48V. Droop function.

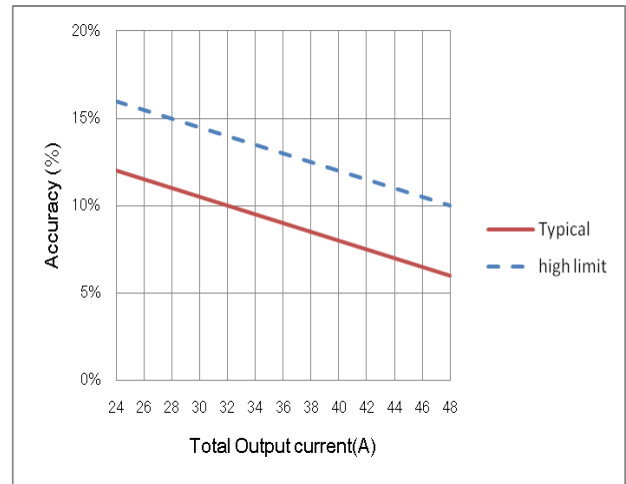

Figure 10: Current share accuracy vs. Total output current
2 in parallel.

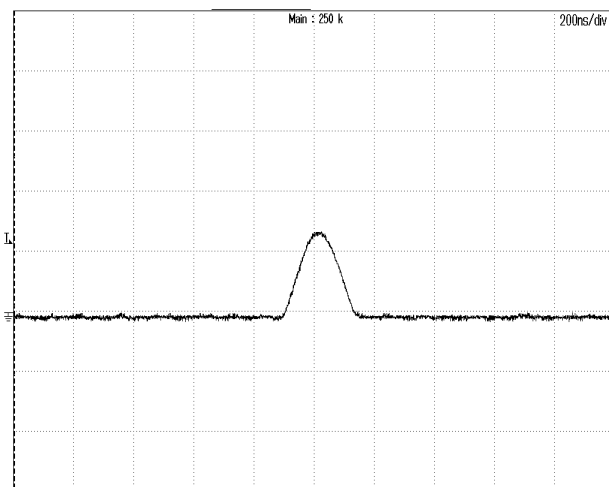

Figure 11: Inrush current @ Vin=48V
CH1:lin, 2A/div, 200nS/div
Max current 2.7A, I2t=1.24E-7 A²S

FEATURES DESCRIPTIONS

Output Over-Current Limit and Short Protection

The modules include internal output over-current limit (OCL) and short circuit protection (SCP) circuits, the OCL set point is lower than that of the SCP; The response of SCP circuit is much fast than that of the OCL circuit. The slowly increase of the output current will let module enter OCL protection when the current exceeds the OCL set point, while the fast increase of the output current will let module enter SCP when the current exceeds the SCP set point.

When the modules enter OCL protection, the output voltage will decrease while the output current is kept constant, the output voltage will soft start to set point when the overload condition is removed.

The module will enter hiccup mode when it triggers the SCP set point. The module will try to restart after shutdown. If the overload condition still exists, the module will shut down again. This restart trial will continue until the overload condition is removed.

Output Over-Voltage Protection

The power module includes an internal output over-voltage protection(OVP) circuit, which monitors the voltage on the output terminals. If this voltage exceeds the OVP set point, the module will shut down, and then restart after a fixed delay time (hiccup mode), please refer to figure6 for detail.

Over-Temperature Protection

The over-temperature protection consists of circuitry that provides protection from thermal damage. If the temperature exceeds the preset temperature threshold the module will shut down, and all components will not exceed their absolute maximum temperature ratings. The module will restart after the temperature is within specification.

Remote On/Off

B40SR13722C has Enable control function. This Enable PIN is designed on the primary side of converter, the converter will turn on when the Enable PIN connected to VIN+, and turn off when the Enable PIN connected to VIN- or floating.

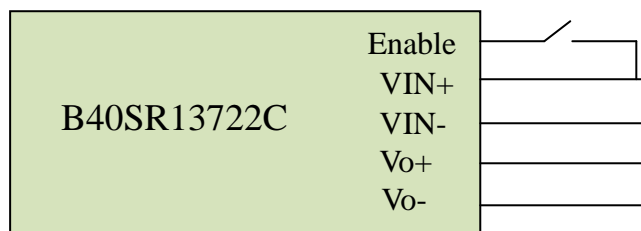

Figure 12: suggested Enable connection

Input Reverse Voltage Protection

The input reverse voltage protection is provided by an diode on the input line, the standoff voltage for the reverse protection shall be no less than -60V.

Parallel connection of multiple units

Two units parallel operation is verified, please contact Delta if more than two units need to be paralleled. While paralleling multiple units, the impedance of the cables from unit to junction point of each unit should be within $\pm 5\%$ of each other.

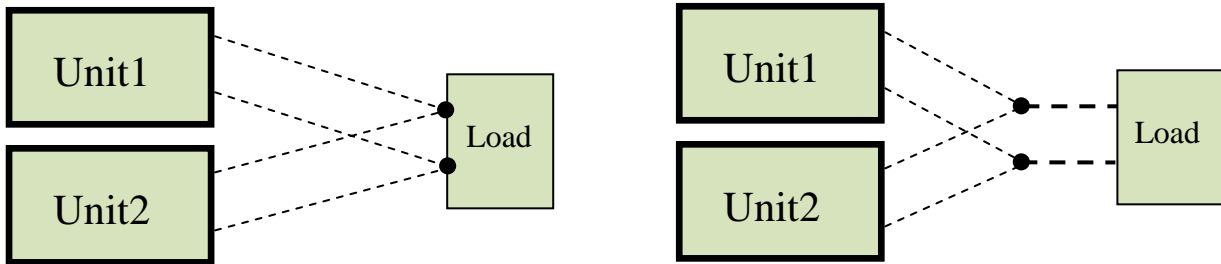

Figure 13: suggested parallel connections

EMC

The converter has the internal EMI filters and meet the EMC standards EN12895 30-100MHz 34-45dBuV/m. The test result is showed as below

Conditions: $V_{in}=48V$, $I_o=22A$, 10m measure distance

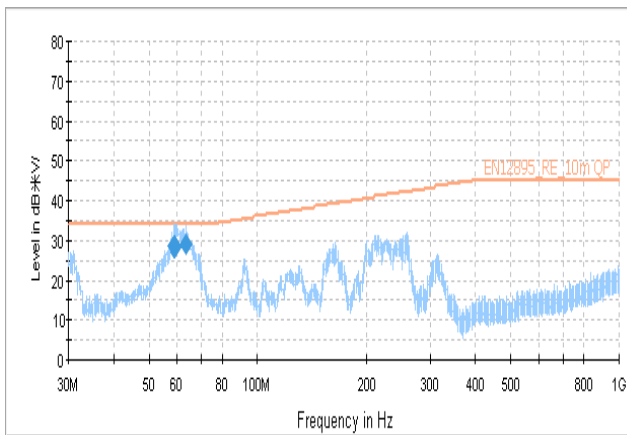

Figure 14: test result (Vertical)

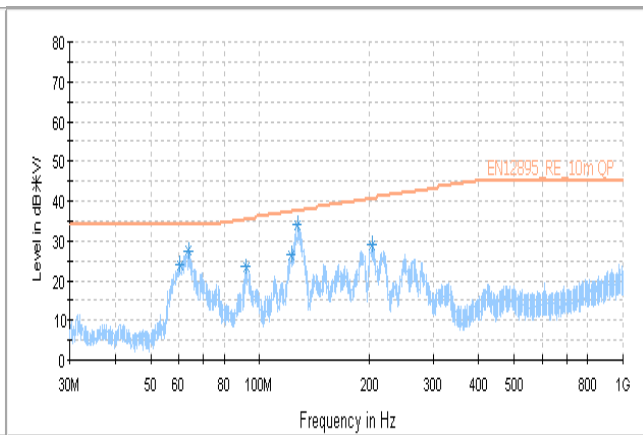

Figure 15: test result (Horizontal)

Fuse replacement

For the versions with the intergrated the fuse holder, when the fuse needs to be replaced, it can be taken down in an anticlockwise direction by slotted type screwdrivers .

Recommended fuse replacement P/N:

Littlefuse 0314030.MXP

THERMAL CONSIDERATION

The thermal curve (Figure17~19) is based on a 250x300x5 AL table, shown as below figure.

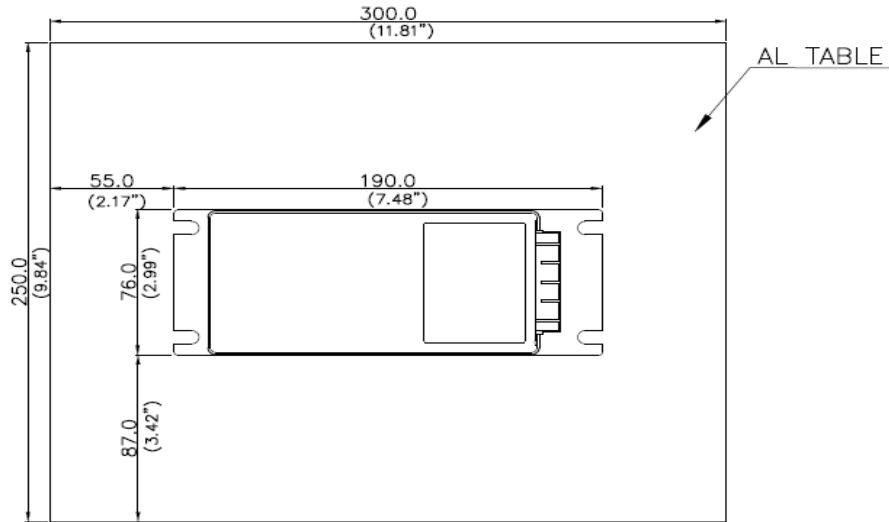

Figure 16: Thermal consideration

THERMAL CURVE

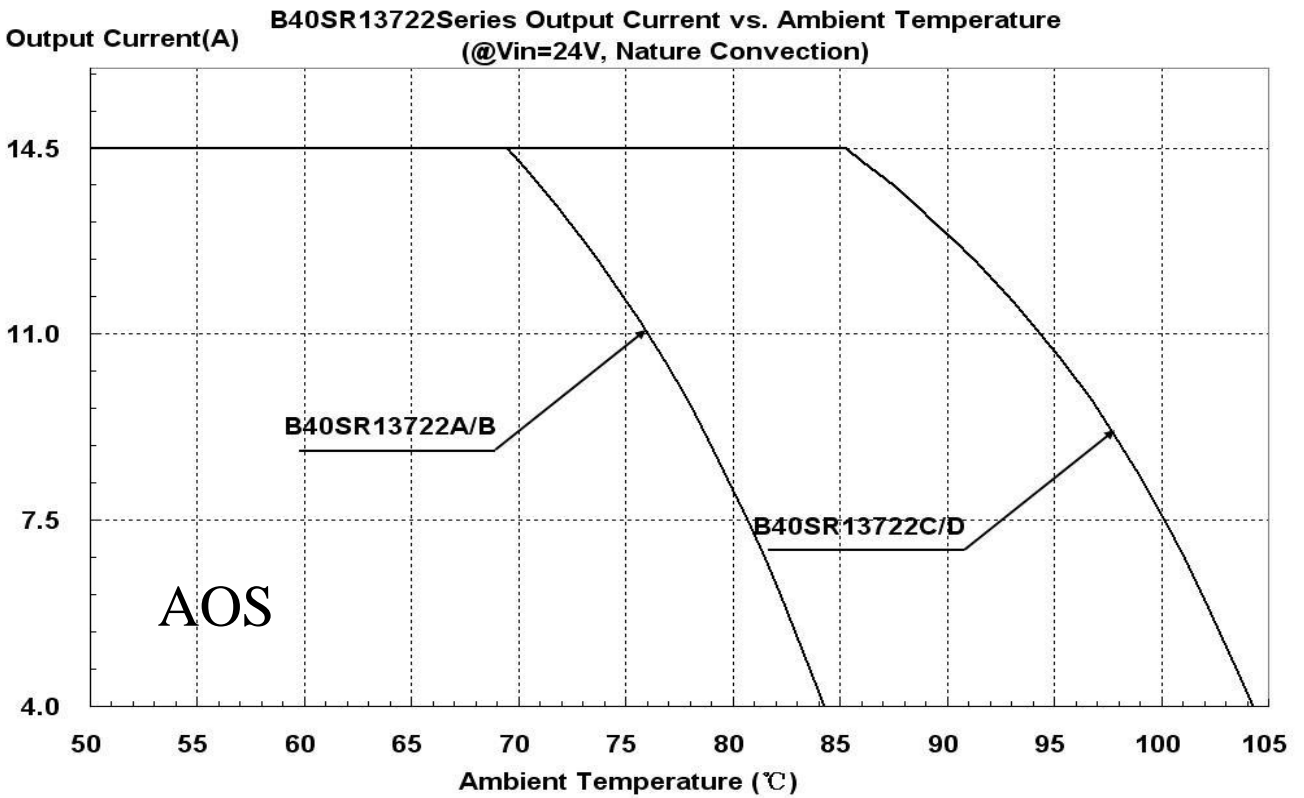

Figure 17: Output Current vs. Ambient temperature @Vin=24V

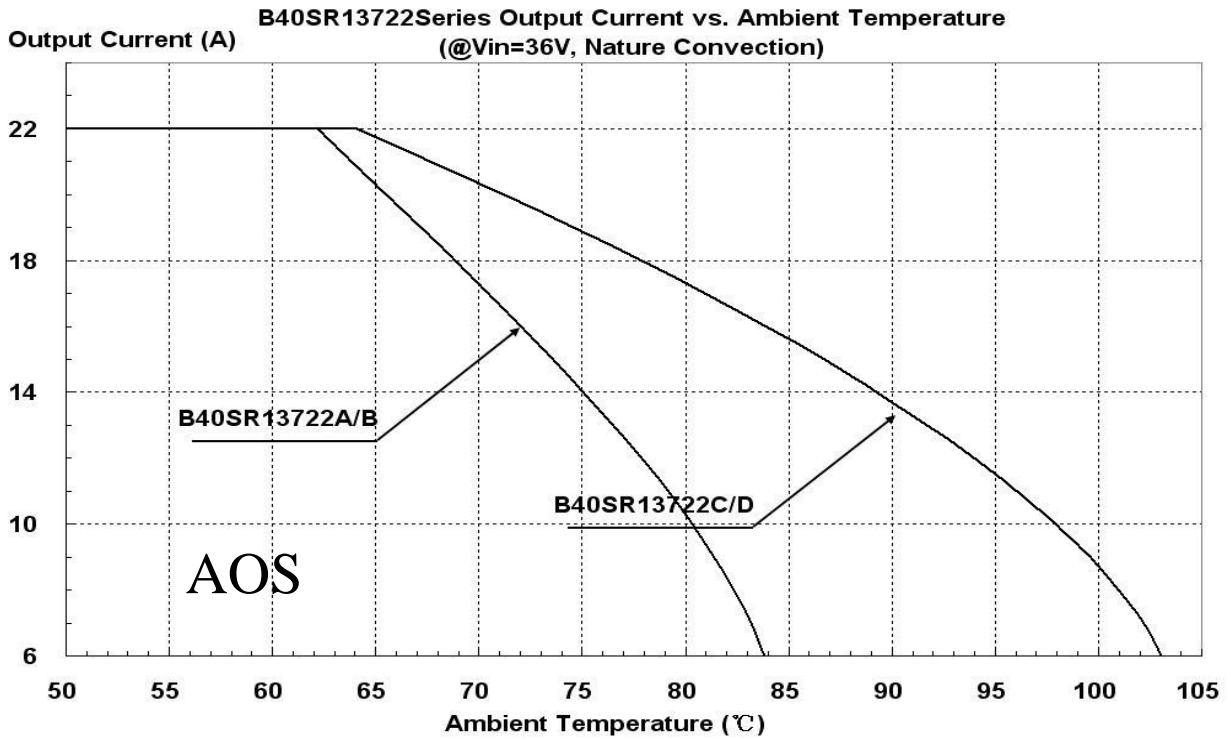

Figure 18: Output Current vs. Ambient temperature @ Vin=36V

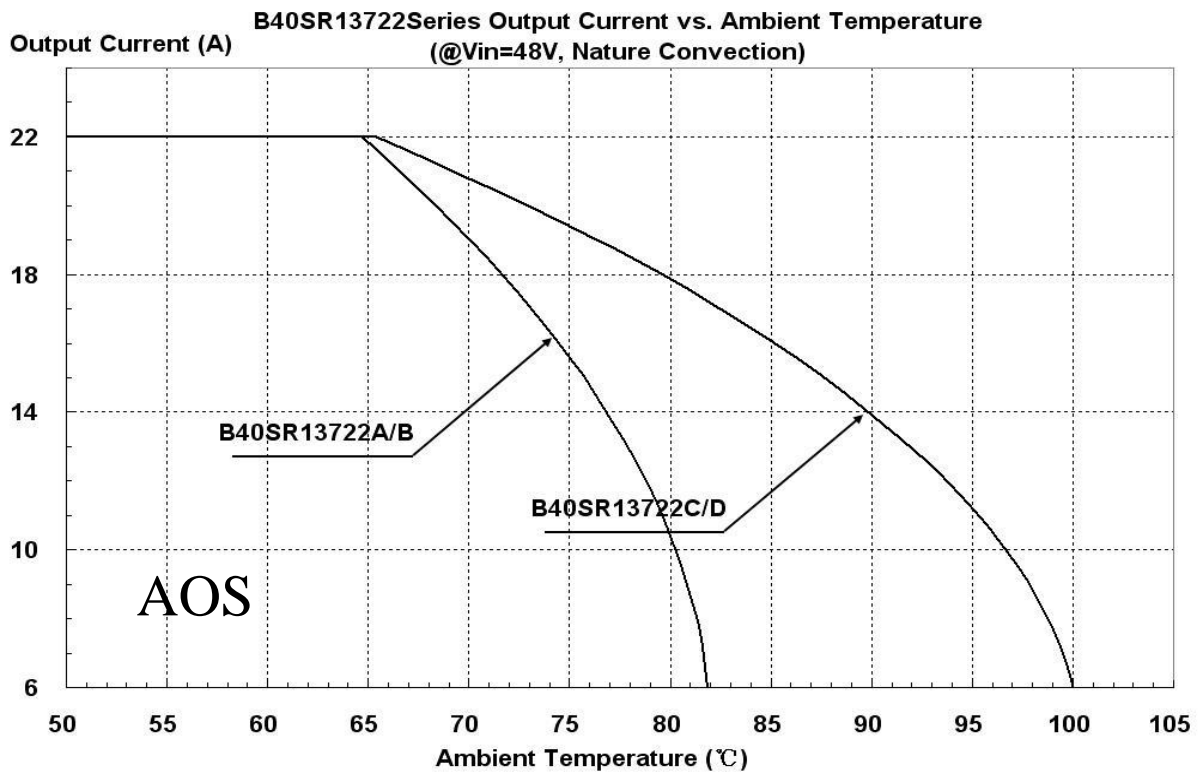

Figure 19: Output Current vs. Ambient temperature @ Vin=48V

THERMAL CONSIDERATION

The following figure shows the location to monitor the temperature of base plate. Before customer decides to use this DCDC converter, a thermal evaluation need to be did to make sure the temperature of base plate is lower than that read from below thermal curves (Figure21~23 base on different input voltage).

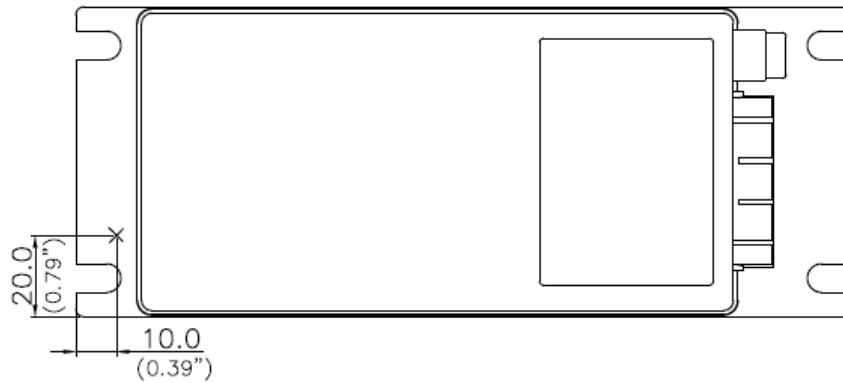

Figure 20: Thermal consideration

THERMAL CURVE

B40SR13722Series Output Current vs. Base Plate Temperature
 (@Vin=24V, Nature Convection)

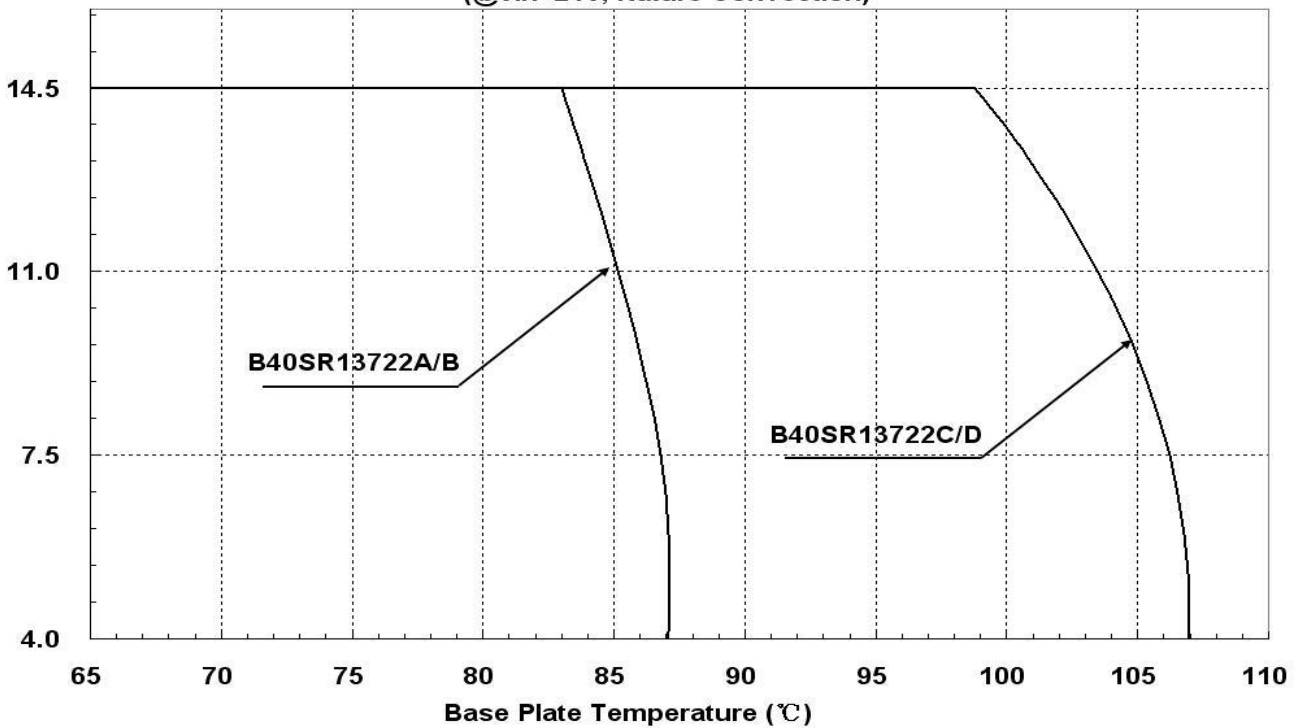

Figure 21: Output Current vs. Base Plate temperature @Vin=24V

THERMAL CURVES

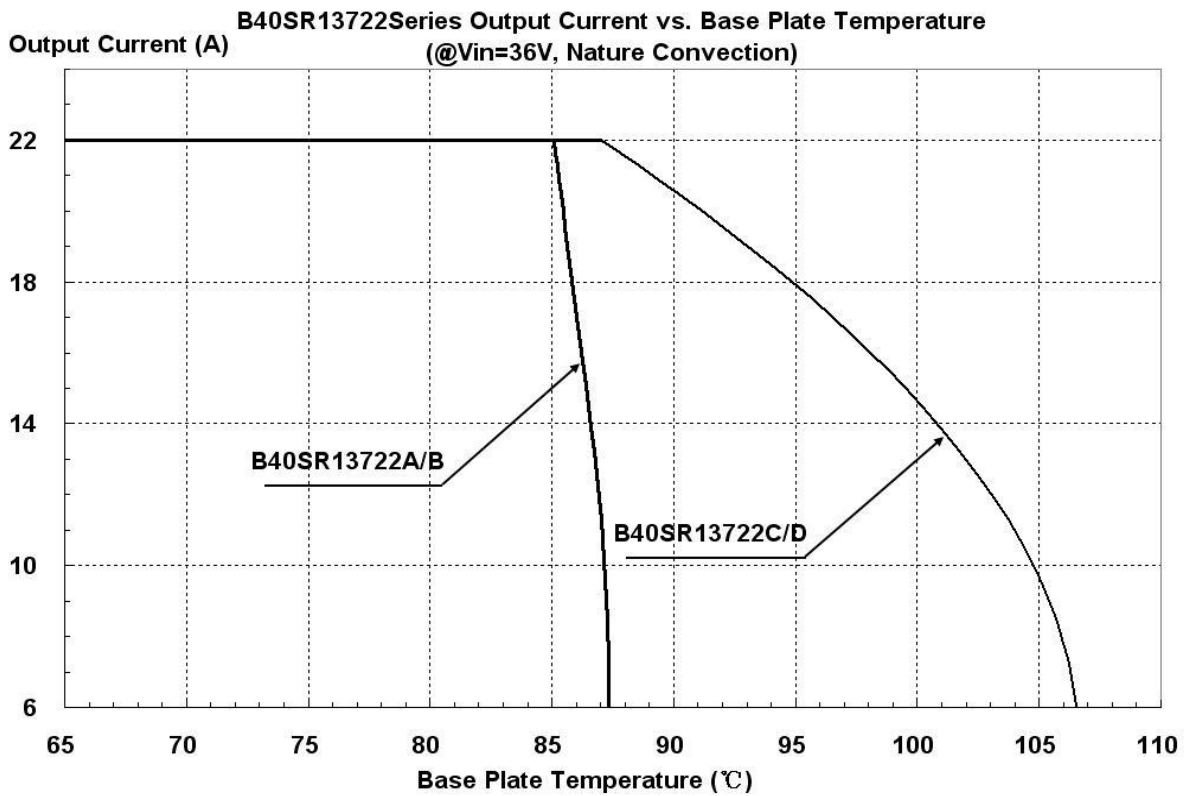

Figure 22: Output Current vs. Base Table temperature @ Vin=36V

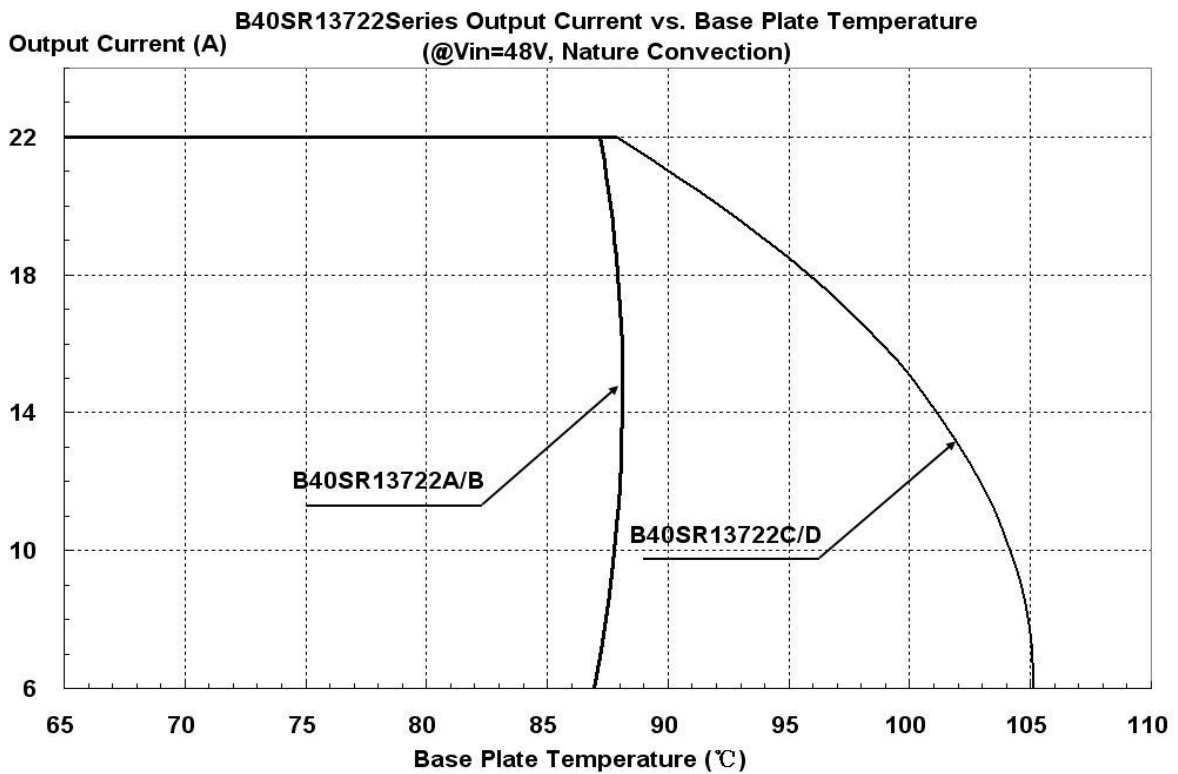
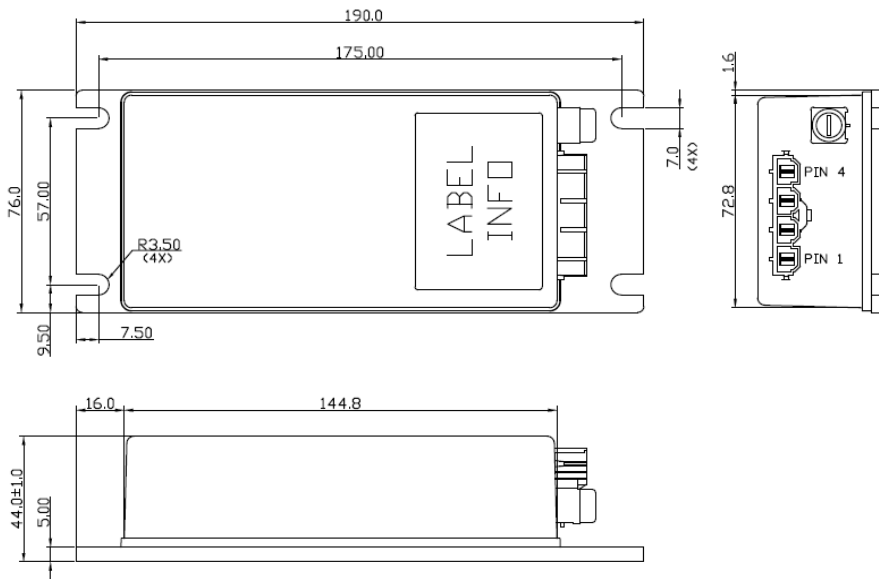

Figure 23: Output Current vs. Base Table temperature @ Vin=48V

Mechanical Drawing

Mechanical Dimensions



B40SR13722A

Pin Connections

Pin	Function Description
1	OUTPUT -
2	OUTPUT +
3	INPUT -
4	INPUT +

- All dimensions in mm (inches)
- Tolerance: X.X±0.5 (X.XX±0.02)
X.XX±0.25 (X.XXX±0.010)
- Connector:
MOLEX MINI-FIT Sr™ Header
(MOLEX P/N :42819-4213)

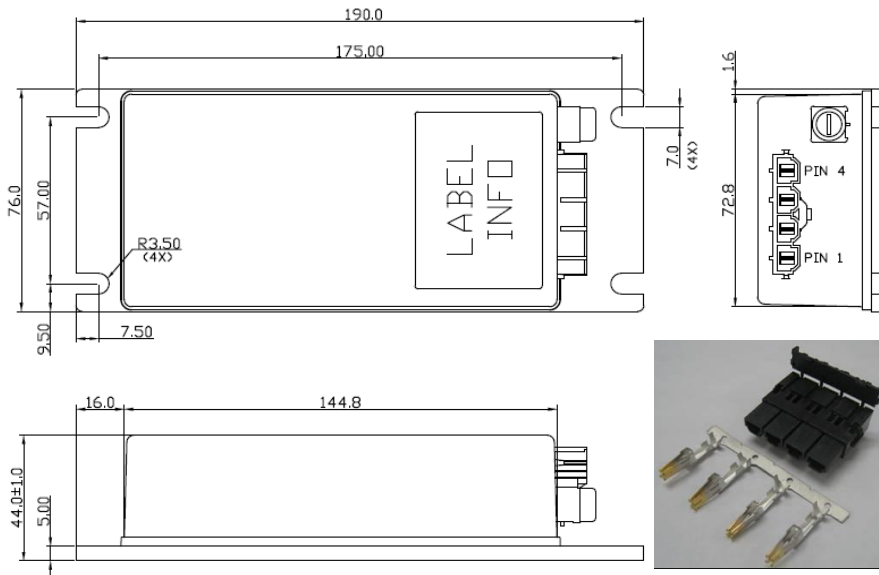

B40SR13722AC

Pin	Function Description
1	OUTPUT -
2	OUTPUT +
3	INPUT -
4	INPUT +

- All dimensions in mm (inches)
- Tolerance: X.X±0.5 (X.XX±0.02)
X.XX±0.25 (X.XXX±0.010)
- Connector:
MOLEX MINI-FIT Sr™ Header
(MOLEX P/N :42819-4213)
- Connector kit :
Housing: 42816-0412
Terminal: 42815-0042

Mechanical Drawing

Mechanical Dimensions

Pin Connections

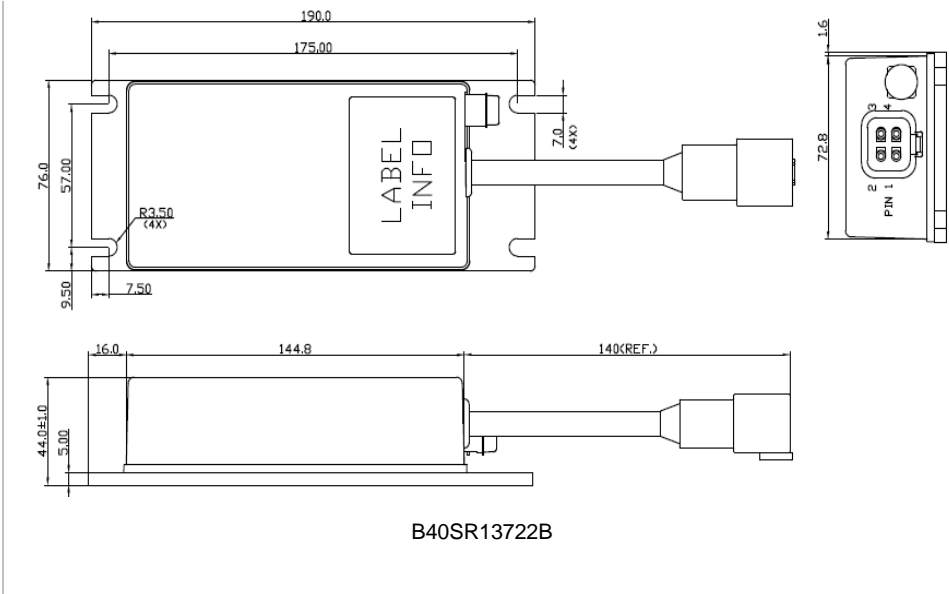

Pin	Function Description
1	OUTPUT -
2	OUTPUT +
3	INPUT -
4	INPUT +

- All dimensions in mm (inches)
- Tolerance: X.X±0.5 (X.XX±0.02)
X.XX±0.25 (X.XXX±0.010)
- Connector:
Deutsch DTP Receptacles
(DEUTSCH P/N :DTP04-4P)

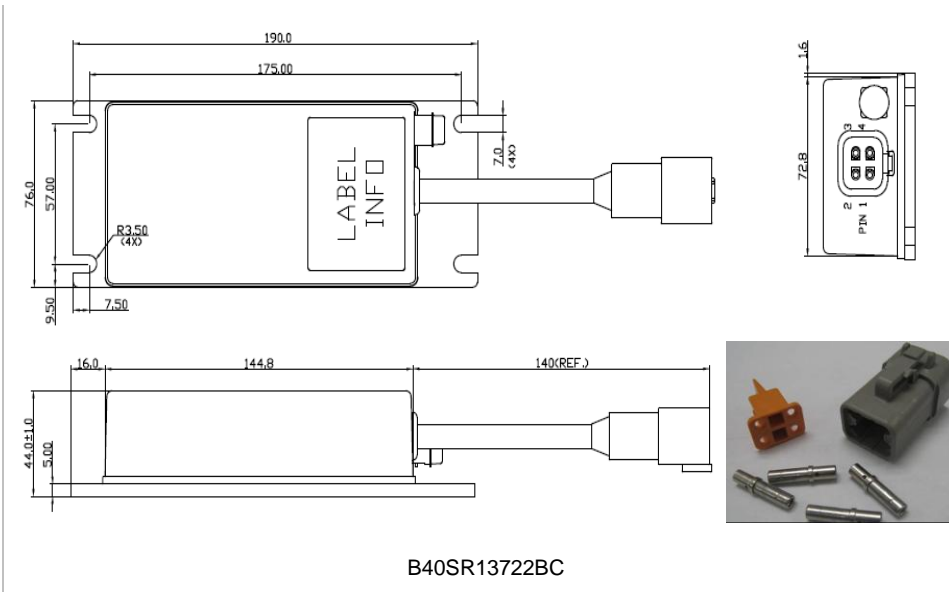

Pin	Function Description
1	OUTPUT -
2	OUTPUT +
3	INPUT -
4	INPUT +

- All dimensions in mm (inches)
- Tolerance: X.X±0.5 (X.XX±0.02)
X.XX±0.25 (X.XXX±0.010)
- Connector:
Deutsch DTP Receptacles
(DEUTSCH P/N :DTP04-4P)
- Connector kit :
Housing: DTP06-4S
Wedge lock: WP-4S
Terminal: 0462-203-12141

Mechanical Drawing

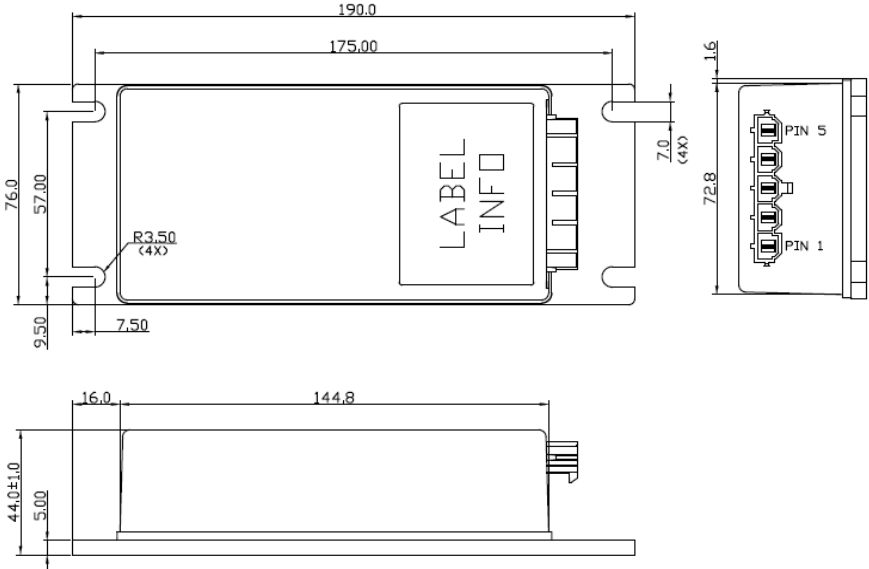
Mechanical Dimensions		Pin Connections	
 <p style="text-align: center;">B40SR13722C</p>		Pin	Function Description
		1	OUTPUT -
		2	OUTPUT +
		3	INPUT -
		4	INPUT +
5	ENABLE		
<ul style="list-style-type: none"> ➤ All dimensions in mm (inches) ➤ Tolerance: X.X±0.5 (X.XX±0.02) X.XX±0.25 (X.XXX±0.010) ➤ Connector: MOLEX MINI-FIT Sr™ Header (MOLEX P/N :42819-5213) 			

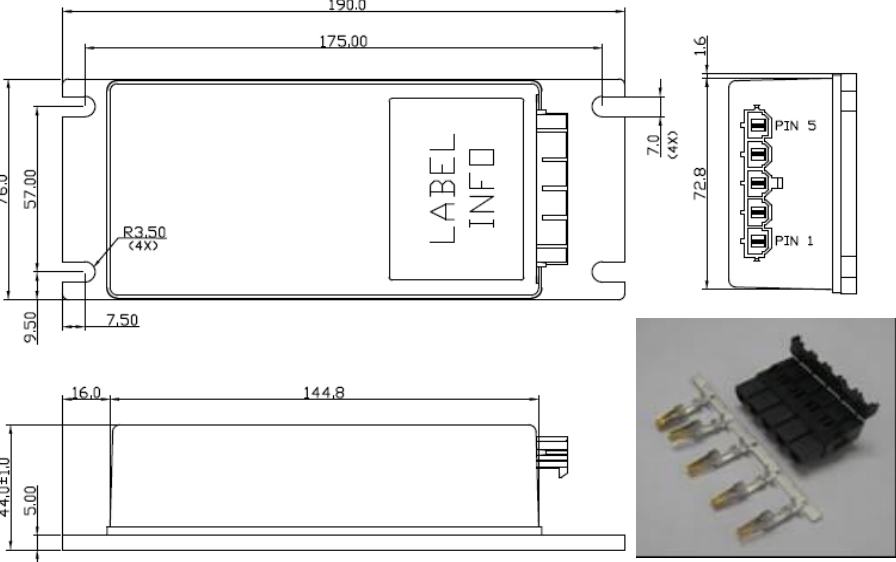
 <p style="text-align: center;">B40SR13722CC</p>		Pin	Function Description
		1	OUTPUT -
		2	OUTPUT +
		3	INPUT -
		4	INPUT +
5	ENABLE		
<ul style="list-style-type: none"> ➤ All dimensions in mm (inches) ➤ Tolerance: X.X±0.5 (X.XX±0.02) X.XX±0.25 (X.XXX±0.010) ➤ Connector: MOLEX MINI-FIT Sr™ Header (MOLEX P/N :42819-5213) ➤ Connector kit : Housing: 42816-0512 Terminal: 42815-0042 			



Part Numbering System

B	40	S	R	137	22	A			C	
Form Factor	Input Voltage	Number of Outputs	Product Series	Output Voltage	Output Current	Option Code			Option Fitting	
B-Box	40 – 18V~60V	S – Single	R – Regular	137 – 13.7V	22 – 22A		With Built-in fuse holder	Enable pin	Sealed connector & fuse holder	Connector Kit
						A	YES	NO	NO	1xhousing+ 4 terminals
						B	YES	NO	YES	1xhousing+ 4 terminals
						C	NO	YES	NO	1xhousing+ 5 terminals
						D	NO	NO	NO	1xhousing+ 4 terminals

Model List

Input Voltage Range	Input		Output		EFF @48VIN 100% LOAD
B40SR13722(A\B\C\D)	18V~60V	13.2A	13.7V	22A	88.7%

CONTACT: www.deltaww.com/dcdc

USA:

Telephone:
 East Coast: 978-656-3993
 West Coast: 510-668-5100
 Fax: (978) 656 3964
 Email: DCDC@delta-corp.com

Europe:

Phone: +31-20-655-0967
 Fax: +31-20-655-0999
 Email: DCDC@delta-es.com

Asia & the rest of world:

Telephone: +886 3 4526107
 ext 6220~6224
 Fax: +886 3 4513485
 Email: DCDC@delta.com.tw

WARRANTY

Delta offers a two (2) years limited warranty. Complete warranty information is listed on our web site or is available upon request from Delta.

Information furnished by Delta is believed to be accurate and reliable. However, no responsibility is assumed by Delta for its use, nor for any infringements of patents or other rights of third parties, which may result from its use. No license is granted by implication or otherwise under any patent or patent rights of Delta. Delta reserves the right to revise these specifications at any time, without notice.

Компания «Океан Электроники» предлагает заключение долгосрочных отношений при поставках импортных электронных компонентов на взаимовыгодных условиях!

Наши преимущества:

- Поставка оригинальных импортных электронных компонентов напрямую с производств Америки, Европы и Азии, а так же с крупнейших складов мира;
- Широкая линейка поставок активных и пассивных импортных электронных компонентов (более 30 млн. наименований);
- Поставка сложных, дефицитных, либо снятых с производства позиций;
- Оперативные сроки поставки под заказ (от 5 рабочих дней);
- Экспресс доставка в любую точку России;
- Помощь Конструкторского Отдела и консультации квалифицированных инженеров;
- Техническая поддержка проекта, помощь в подборе аналогов, поставка прототипов;
- Поставка электронных компонентов под контролем ВП;
- Система менеджмента качества сертифицирована по Международному стандарту ISO 9001;
- При необходимости вся продукция военного и аэрокосмического назначения проходит испытания и сертификацию в лаборатории (по согласованию с заказчиком);
- Поставка специализированных компонентов военного и аэрокосмического уровня качества (Xilinx, Altera, Analog Devices, Intersil, Interpoint, Microsemi, Actel, Aeroflex, Peregrine, VPT, Syfer, Eurofarad, Texas Instruments, MS Kennedy, Miteq, Cobham, E2V, MA-COM, Hittite, Mini-Circuits, General Dynamics и др.);

Компания «Океан Электроники» является официальным дистрибьютором и эксклюзивным представителем в России одного из крупнейших производителей разъемов военного и аэрокосмического назначения «JONHON», а так же официальным дистрибьютором и эксклюзивным представителем в России производителя высокотехнологичных и надежных решений для передачи СВЧ сигналов «FORSTAR».



JONHON

«JONHON» (основан в 1970 г.)

Разъемы специального, военного и аэрокосмического назначения:

(Применяются в военной, авиационной, аэрокосмической, морской, железнодорожной, горно- и нефтедобывающей отраслях промышленности)

«FORSTAR» (основан в 1998 г.)

ВЧ соединители, коаксиальные кабели, кабельные сборки и микроволновые компоненты:

(Применяются в телекоммуникациях гражданского и специального назначения, в средствах связи, РЛС, а так же военной, авиационной и аэрокосмической отраслях промышленности).



Телефон: 8 (812) 309-75-97 (многоканальный)

Факс: 8 (812) 320-03-32

Электронная почта: ocean@oceanchips.ru

Web: <http://oceanchips.ru/>

Адрес: 198099, г. Санкт-Петербург, ул. Калинина, д. 2, корп. 4, лит. А