

**Balun transformers**  
**Wound SMD**  
**ATB series**



# ATB3225 type



## FEATURES

- The ATB3225 case size is L3.2×W2.5×H2.3mm.
- The case size is smaller than conventional Baluns.
- The frequency band width for ATB3225-75011CT is 5 to 200MHz, for ATB3225-75032CT is 5 to 100MHz, for ATB3225-75034CT is 1 to 100MHz, and for ATB3225-50011CT is 1 to 100MHz.
- Low insertion loss and good balance parameters.

## APPLICATION

- Cable modem

## PART NUMBER CONSTRUCTION

|             |                                      |   |                         |                                  |                 |   |                 |               |
|-------------|--------------------------------------|---|-------------------------|----------------------------------|-----------------|---|-----------------|---------------|
| ATB         | 3225                                 | - | 750                     | 11                               | CT              | - | T               | 001           |
| Series name | LxWxH dimensions (mm)<br>3.2x2.5x2.3 |   | Impedance (Ω) at 100MHz | Impedance ratio                  | Type            |   | Packaging style | Internal code |
|             |                                      |   | 750   75<br>500   50    | 11   1:1<br>32   3:2<br>34   3:4 | CT   Center tap |   | T   ø180mm reel |               |

## CHARACTERISTICS SPECIFICATION TABLE

| DC resistance (Ω)max. | Impedance ratio | Frequency range (MHz) | Insertion loss (dB)max. | Return loss (dB)min. | Amplitude unbalance (dB)max. | Phase difference (deg.) | Part No.                             |
|-----------------------|-----------------|-----------------------|-------------------------|----------------------|------------------------------|-------------------------|--------------------------------------|
| 0.7                   | 1:1 (75Ω:75Ω)   | 5 to 65<br>5 to 200   | 0.8<br>1.5              | 15<br>10             | 0.1<br>0.5                   | 180±2<br>180±5          | <a href="#">ATB3225-75011CT-T001</a> |
| 0.7                   | 3:2 (75Ω:50Ω)   | 5 to 100              | 2                       | 5                    | 1                            | 180±10                  | <a href="#">ATB3225-75032CT-T001</a> |
| 0.7                   | 3:4 (75Ω:100Ω)  | 1 to 100              | 2                       | 5                    | 0.1                          | 180±10                  | <a href="#">ATB3225-75034CT-T000</a> |
| 0.7                   | 1:1(50Ω: 50Ω)   | 1<br>100              | 0.8<br>1.5              | 15<br>10             | 0.1<br>0.5                   | 180±2<br>180±5          | <a href="#">ATB3225-50011CT-T000</a> |

\* Temperature derating was considered for the rated current.

### Measurement equipment

| Measurement item    | Product No. | Manufacturer          |
|---------------------|-------------|-----------------------|
| Insertion loss      | E5071B      | Keysight Technologies |
| Return loss         | E5071B      | Keysight Technologies |
| Amplitude unbalance | E5071B      | Keysight Technologies |
| Phase difference    | E5071B      | Keysight Technologies |

\* Equivalent measurement equipment may be used.



# ATB3225 type

## FREQUENCY CHARACTERISTICS

### ATB3225-75011CT-T001

#### INSERTION LOSS

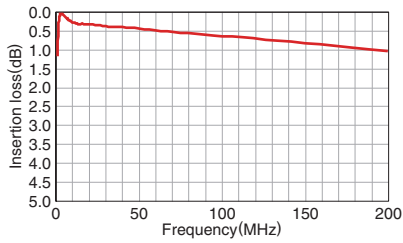

#### RETURN LOSS

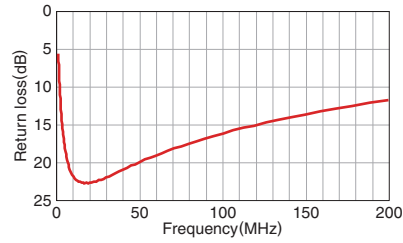

#### AMPLITUDE UNBALANCE

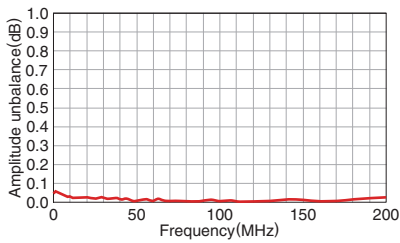

#### PHASE UNBALANCE

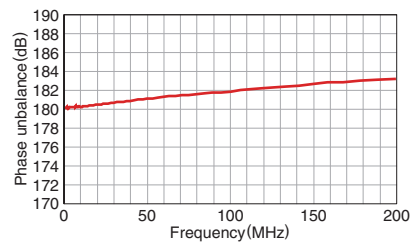

### ATB3225-75032CT-T001

#### INSERTION LOSS

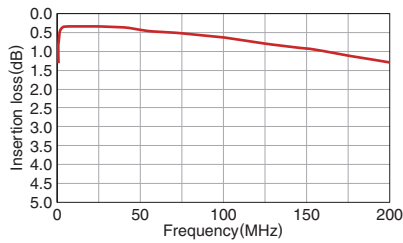

#### RETURN LOSS

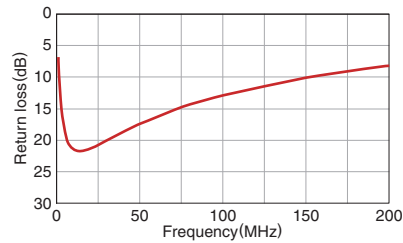

#### AMPLITUDE BALANCE

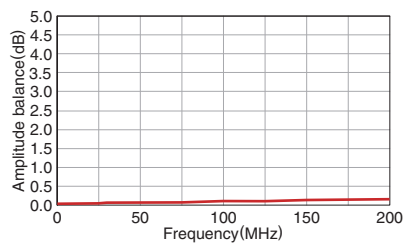

#### PHASE BALANCE

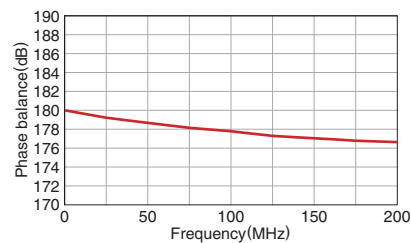

# ATB3225 type

## FREQUENCY CHARACTERISTICS

### ATB3225-75034CT-T000

#### INSERTION LOSS

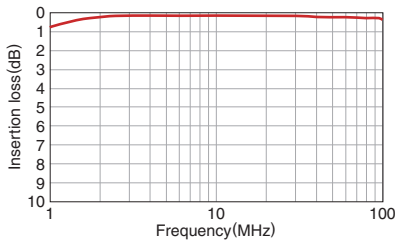

#### RETURN LOSS

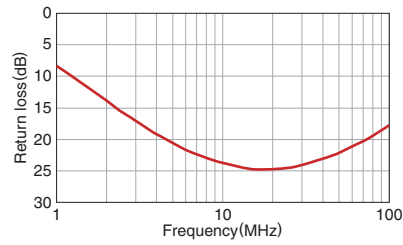

#### AMPLITUDE IMBALANCE

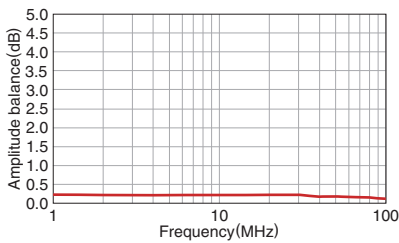

#### PHASE BALANCE

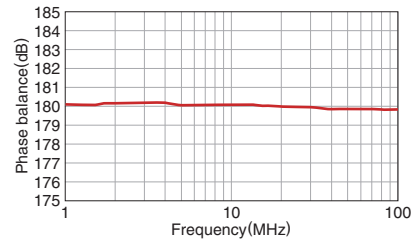

### ATB3225-50011CT-T000

#### INSERTION LOSS

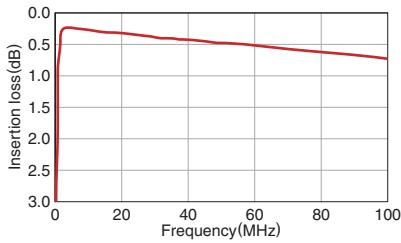

#### RETURN LOSS

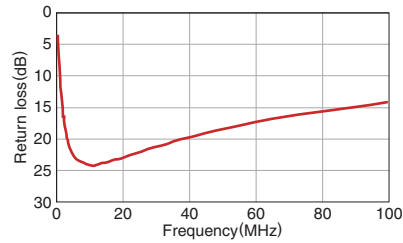

#### AMPLITUDE IMBALANCE

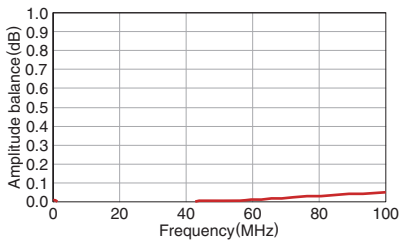

#### PHASE BALANCE

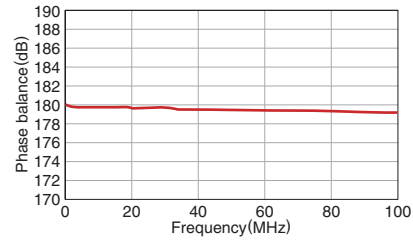

# ATB3225 type

## SHAPE & DIMENSIONS

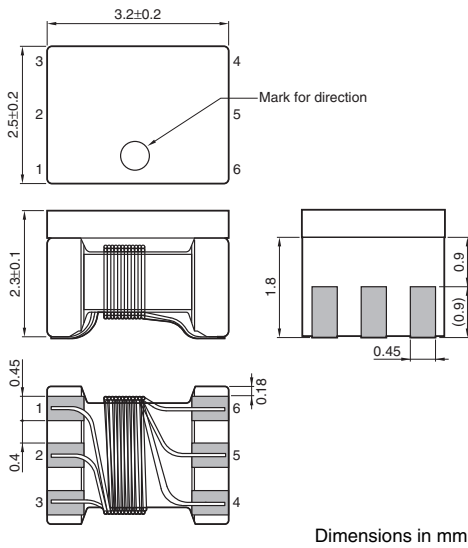

## RECOMMENDED LAND PATTERN

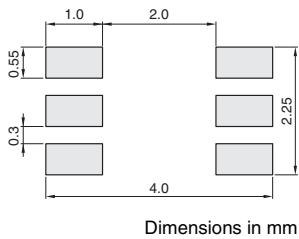

## CIRCUIT DIAGRAM

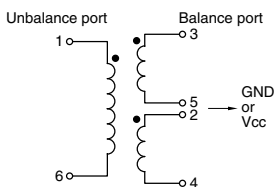

## RECOMMENDED REFLOW PROFILE

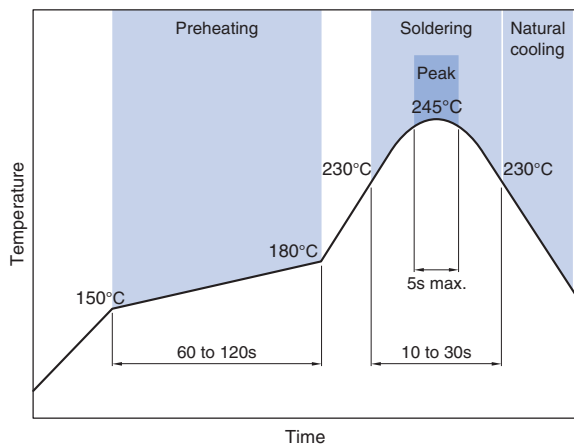

## PACKAGING STYLE

### REEL DIMENSIONS

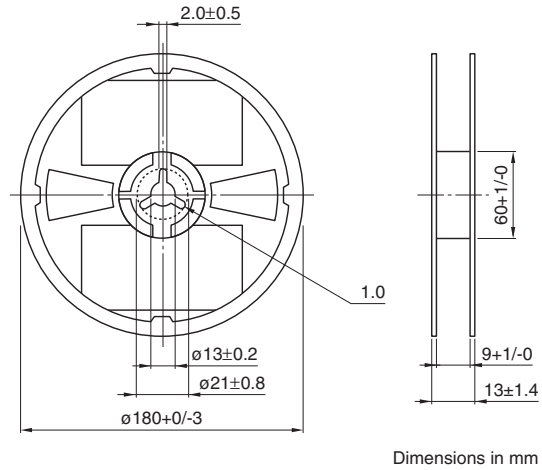

### TAPE DIMENSIONS

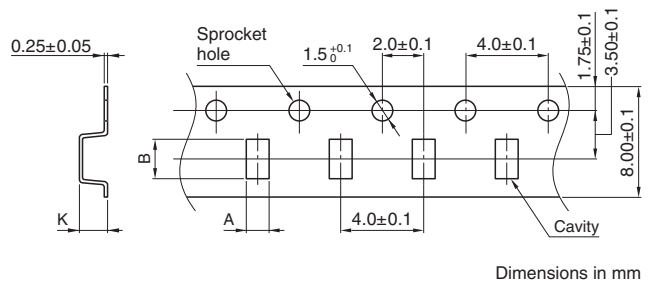

| Type    | A        | B        | K        |
|---------|----------|----------|----------|
| ATB3225 | 2.90±0.1 | 3.60±0.1 | 2.5±0.05 |

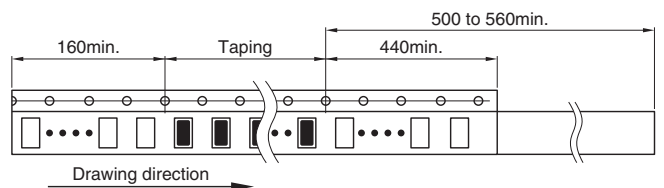

### PACKAGE QUANTITY

|                  |               |
|------------------|---------------|
| Package quantity | 1000 pcs/reel |
|------------------|---------------|

### TEMPERATURE RANGE, INDIVIDUAL WEIGHT

| Operating temperature range | Storage temperature range* | Individual weight |
|-----------------------------|----------------------------|-------------------|
| -40 to +85°C                | -40 to +85°C               | 75 mg             |

\* The storage temperature range is for after the assembly.

## REMINDERS FOR USING THESE PRODUCTS

Before using these products, be sure to request the delivery specifications.

### SAFETY REMINDERS

Please pay sufficient attention to the warnings for safe designing when using this products.

#### REMINDERS

- The storage period is within 6 months. Be sure to follow the storage conditions (temperature: 5 to 40°C, humidity: 10 to 75% RH or less).  
If the storage period elapses, the soldering of the terminal electrodes may deteriorate.
- Do not use or store in locations where there are conditions such as gas corrosion (salt, acid, alkali, etc.).
- Before soldering, be sure to preheat components.  
The preheating temperature should be set so that the temperature difference between the solder temperature and chip temperature does not exceed 150°C.
- Soldering corrections after mounting should be within the range of the conditions determined in the specifications.  
If overheated, a short circuit, performance deterioration, or lifespan shortening may occur.
- When embedding a printed circuit board where a chip is mounted to a set, be sure that residual stress is not given to the chip due to the overall distortion of the printed circuit board and partial distortion such as at screw tightening portions.
- Self heating (temperature increase) occurs when the power is turned ON, so the tolerance should be sufficient for the set thermal design.
- Carefully lay out the coil for the circuit board design of the non-magnetic shield type.  
A malfunction may occur due to magnetic interference.
- Use a wrist band to discharge static electricity in your body through the grounding wire.
- Do not expose the products to magnets or magnetic fields.
- Do not use for a purpose outside of the contents regulated in the delivery specifications.
- The products listed on this catalog are intended for use in general electronic equipment (AV equipment, telecommunications equipment, home appliances, amusement equipment, computer equipment, personal equipment, office equipment, measurement equipment, industrial robots) under a normal operation and use condition.  
The products are not designed or warranted to meet the requirements of the applications listed below, whose performance and/or quality require a more stringent level of safety or reliability, or whose failure, malfunction or trouble could cause serious damage to society, person or property.  
If you intend to use the products in the applications listed below or if you have special requirements exceeding the range or conditions set forth in the each catalog, please contact us.

- (1) Aerospace/aviation equipment
- (2) Transportation equipment (cars, electric trains, ships, etc.)
- (3) Medical equipment
- (4) Power-generation control equipment
- (5) Atomic energy-related equipment
- (6) Seabed equipment
- (7) Transportation control equipment

- (8) Public information-processing equipment
- (9) Military equipment
- (10) Electric heating apparatus, burning equipment
- (11) Disaster prevention/crime prevention equipment
- (12) Safety equipment
- (13) Other applications that are not considered general-purpose applications

When designing your equipment even for general-purpose applications, you are kindly requested to take into consideration securing protection circuit/device or providing backup circuits in your equipment.

Компания «Океан Электроники» предлагает заключение долгосрочных отношений при поставках импортных электронных компонентов на взаимовыгодных условиях!

Наши преимущества:

- Поставка оригинальных импортных электронных компонентов напрямую с производств Америки, Европы и Азии, а так же с крупнейших складов мира;
- Широкая линейка поставок активных и пассивных импортных электронных компонентов (более 30 млн. наименований);
- Поставка сложных, дефицитных, либо снятых с производства позиций;
- Оперативные сроки поставки под заказ (от 5 рабочих дней);
- Экспресс доставка в любую точку России;
- Помощь Конструкторского Отдела и консультации квалифицированных инженеров;
- Техническая поддержка проекта, помощь в подборе аналогов, поставка прототипов;
- Поставка электронных компонентов под контролем ВП;
- Система менеджмента качества сертифицирована по Международному стандарту ISO 9001;
- При необходимости вся продукция военного и аэрокосмического назначения проходит испытания и сертификацию в лаборатории (по согласованию с заказчиком);
- Поставка специализированных компонентов военного и аэрокосмического уровня качества (Xilinx, Altera, Analog Devices, Intersil, Interpoint, Microsemi, Actel, Aeroflex, Peregrine, VPT, Syfer, Eurofarad, Texas Instruments, MS Kennedy, Miteq, Cobham, E2V, MA-COM, Hittite, Mini-Circuits, General Dynamics и др.);

Компания «Океан Электроники» является официальным дистрибьютором и эксклюзивным представителем в России одного из крупнейших производителей разъемов военного и аэрокосмического назначения «JONHON», а так же официальным дистрибьютором и эксклюзивным представителем в России производителя высокотехнологичных и надежных решений для передачи СВЧ сигналов «FORSTAR».



## JONHON

«JONHON» (основан в 1970 г.)

Разъемы специального, военного и аэрокосмического назначения:

(Применяются в военной, авиационной, аэрокосмической, морской, железнодорожной, горно- и нефтедобывающей отраслях промышленности)

«FORSTAR» (основан в 1998 г.)

ВЧ соединители, коаксиальные кабели, кабельные сборки и микроволновые компоненты:

(Применяются в телекоммуникациях гражданского и специального назначения, в средствах связи, РЛС, а так же военной, авиационной и аэрокосмической отраслях промышленности).



Телефон: 8 (812) 309-75-97 (многоканальный)

Факс: 8 (812) 320-03-32

Электронная почта: [ocean@oceanchips.ru](mailto:ocean@oceanchips.ru)

Web: <http://oceanchips.ru/>

Адрес: 198099, г. Санкт-Петербург, ул. Калинина, д. 2, корп. 4, лит. А