

THIS DRAWING IS UNPUBLISHED. RELEASED FOR PUBLICATION  
 © COPYRIGHT - By - ALL RIGHTS RESERVED.

LOC		DIST		REVISIONS			
P	LTR	DESCRIPTION		DATE	DWN	APVD	
	H2	REVISED PER ECO-11-004587		11MAR11	RK	HMR	

-	-	-	-	-	-	-	-	-	-	-	-	-	-	-	180.7	188.2	18	1-1546306-8	
-	-	-	-	-	-	-	-	-	-	-	-	-	-	-	171.2	178.7	17	1-1546306-7	
-	-	-	-	-	-	-	-	-	-	-	-	-	-	-	161.7	169.2	16	1-1546306-6	
△△△△	-	-	-	-	-	-	-	-	-	-	-	-	-	-	152.2	159.7	15	6-1546306-2	
-	-	-	-	-	-	-	-	-	-	-	-	-	-	-	152.2	159.7	15	1-1546306-5	
-	-	-	-	-	-	-	-	-	-	-	-	-	-	-	142.7	150.2	14	1-1546306-4	
-	-	-	-	-	-	-	-	-	-	-	-	-	-	-	133.2	140.7	13	1-1546306-3	
△△	-	-	-	-	-	-	-	-	-	-	-	-	-	-	123.7	131.2	12	4-1546306-0	
△△	-	-	-	-	-	-	-	-	-	-	-	-	-	-	123.7	131.2	12	3-1546306-3	
-	-	-	-	-	-	-	-	-	-	-	-	-	-	-	123.7	131.2	12	1-1546306-2	
△	-	-	-	11	-	-	-	-	-	-	-	-	-	-	114.2	121.7	11	5-1546306-2	
△△	-	-	-	-	2	-	-	-	-	-	11	-	-	-	114.2	121.7	11	3-1546306-4	
△	-	-	-	-	-	-	-	-	-	-	11	-	-	-	114.2	121.7	11	3-1546306-1	
-	-	-	-	-	-	-	-	-	-	-	-	-	-	-	114.2	121.7	11	1-1546306-1	
△	-	-	-	-	-	-	-	-	-	10	3	-	-	-	104.7	112.2	10	6-1546306-0	
△△	-	-	-	-	-	-	-	-	-	-	-	-	-	-	104.7	112.2	10	5-1546306-8	
-	-	-	-	-	-	-	-	-	-	-	-	-	-	-	104.7	112.2	10	1-1546306-0	
△△△	-	4	9	-	-	-	-	-	-	-	-	-	-	-	95.2	102.7	9	6-1546306-3	
△△	-	-	-	-	-	-	-	-	-	-	-	-	-	-	95.2	102.7	9	5-1546306-6	
-	-	-	-	-	-	-	-	-	-	-	-	-	-	-	95.2	102.7	9	1546306-9	
-	-	-	-	-	-	-	-	-	-	8	-	-	-	-	85.7	93.2	8	5-1546306-9	
△△	-	-	-	-	-	-	-	-	-	-	-	-	-	-	85.7	93.2	8	3-1546306-9	
-	-	-	-	-	-	-	-	-	-	-	-	-	-	-	85.7	93.2	8	1546306-8	
△△	-	-	-	-	-	-	-	-	-	-	-	-	-	-	76.2	83.7	7	5-1546306-5	
△	-	-	-	-	1	-	-	-	7	-	-	-	-	-	76.2	83.7	7	5-1546306-0	
-	-	-	-	-	-	-	-	-	-	-	-	-	7	7	76.2	83.7	7	4-1546306-5	
△	-	-	-	-	-	-	-	-	-	-	-	-	-	-	76.2	83.7	7	3-1546306-7	
-	-	-	-	-	-	-	-	-	-	-	-	-	-	-	76.2	83.7	7	1546306-7	
△△	-	-	-	-	-	-	-	-	-	-	-	-	-	-	66.7	74.2	6	5-1546306-4	
△△	-	-	-	-	-	-	-	-	-	-	-	-	-	-	66.7	74.2	6	4-1546306-9	
-	-	-	-	-	-	6	-	-	-	-	-	-	-	-	66.7	74.2	6	4-1546306-8	
-	-	-	-	-	-	-	-	-	-	-	-	-	6	6	66.7	74.2	6	4-1546306-4	
△	-	-	-	-	-	-	-	-	-	-	-	-	-	-	66.7	74.2	6	3-1546306-6	
-	-	-	-	-	-	-	-	-	-	-	-	-	-	-	66.7	74.2	6	1546306-6	
△	-	-	-	-	-	-	-	-	-	5	-	-	-	-	57.2	64.7	5	5-1546306-7	
△	-	5	5	-	-	-	-	-	-	-	-	-	-	-	57.2	64.7	5	5-1546306-3	
△△ SCREW ON ONE SIDE	-	-	-	-	-	-	-	-	-	-	-	-	-	-	57.2	64.7	5	4-1546306-7	
-	-	-	-	-	-	-	-	-	-	-	-	-	5	5	57.2	64.7	5	4-1546306-3	
△	-	-	-	-	-	-	-	-	-	-	-	-	-	-	57.2	64.7	5	3-1546306-5	
-	-	-	-	-	-	-	-	-	-	-	-	-	-	-	57.2	64.7	5	1546306-5	
△△	-	-	-	-	-	-	-	-	-	-	-	-	-	4	4	47.7	55.2	4	4-1546306-2
-	-	-	-	-	-	-	-	-	-	-	-	-	-	-	47.7	55.2	4	3-1546306-8	
-	-	-	-	-	-	-	-	-	-	-	-	-	-	-	47.7	55.2	4	1546306-4	
-	3	3	-	-	-	-	-	-	-	-	-	-	-	-	38.2	45.7	3	6-1546306-1	
-	-	-	-	-	-	-	-	-	-	-	-	-	-	-	38.2	45.7	3	5-1546306-1	
-	-	-	-	-	-	-	-	-	-	-	-	-	-	-	38.2	45.7	3	1546306-3	
△	-	-	-	-	-	-	-	-	2	2	2	-	-	-	28.7	36.2	2	4-1546306-6	
-	-	-	-	-	-	2	2	2	-	-	-	-	-	-	28.7	36.2	2	4-1546306-1	
-	-	-	-	-	-	-	-	-	-	-	-	-	-	-	28.7	36.2	2	1546306-2	

NOTES	13	12	11	10	9	8	7	6	5	4	3	2	1	DIM B	DIM A	NO. OF POS.	PART NO.
	QC TAB .187 SS FLAT	QC TAB .187 SS FLAT	QC TAB .187 SS 90°	JUMPER	QC TAB DBL SIDE 90° .250	QC TAB DBL SIDE 45° .250	QC TAB DBL SIDE FLAT .250	QC TAB DBL SIDE 90° .187	QC TAB DBL SIDE 45° .187	QC TAB DBL SIDE FLAT .187	QC TAB SGL SIDE .250	QC TAB SGL SIDE 45° .250	QC TAB SGL SIDE FLAT .250				

THIS DRAWING IS A CONTROLLED DOCUMENT.

DWN: S SCHLEGEL 20AUG2002  
 CHK: C RICHARD 8/20/02  
 APVD: C RICHARD 8/20/02

TE Connectivity

9.50MM (.374) DBL ROW BARRIER STRIP W/O WASHER

SIZE: A2 CAGE CODE: 00779 DRAWING NO: C=1546306 RESTRICTED TO: -

SCALE: NTS SHEET: 1 OF 3 REV: H2

CUSTOMER DRAWING

THIS DRAWING IS UNPUBLISHED. RELEASED FOR PUBLICATION  
 © COPYRIGHT - By - ALL RIGHTS RESERVED.

LOC		DIST		REVISIONS			
P	LTR	DESCRIPTION	DATE	DWN	APVD		
-	-	SEE SHEET 1	-	-	-		

PHYSICAL PROPERTIES:  
 HOUSING MATERIAL: THERMOPLASTIC, PC  
 FLAMMABILITY: UL94V-0 COLOR: BLACK  
 MAX BOW/WARP: .0056 IN/IN.

TERMINAL:  
 TERMINALS: BRASS, TIN PLATED  
 SCREWS: 6-32, STEEL, NICKEL PLATED

MECHANICAL:  
 PITCH (TERMINAL SPACING): 9.50mm(.374")  
 WIRE RANGE: 12-22 AWG  
 RECOMMENDED TIGHTENING TORQUE: 12IN-LBS MAX.

ELECTRICAL PROPERTIES:  
 MAXIMUM CURRENT: 20A  
 OPERATING VOLTAGE: 300V

ENVIRONMENTAL PROPERTIES:  
 OPERATING TEMP RANGE: -40°C TO +120°C.

- 1 SEE FIGURE.
- 2 MARKED WITH WHITE INK.
- 3 PRELIMINARY PART NUMBER.
- 4 SCREWS AND TERMINALS ARE NICKEL PLATED BRASS.
- 5 STAINLESS STEEL SCREWS.
- 6 SCREWS ARE NICKEL PLATED BRASS.
- 7 WIRE CLAMP SCREWS TO BE USED ONLY ON SIDE OPPOSITE QC TABS.
- 8 TE CONNECTIVITY LOGO LOCATED APPROXIMATE AREA SHOWN.

-- SELECT LOAD CHART --

-	-	4-5,5-6	-	-	-	-	ALL	-	-	-	-	11	3-1546306-4												
-	-	-	-	-	-	-	ALL	1-3	-	-	-	10	6-1546306-0												
-	-	1,2	-	-	-	ALL	-	-	-	-	-	7	5-1546306-0												
-	-	-	-	-	1	ALL	-	-	-	-	-	6	4-1546306-9												
12	QC TAB .187 SS FLAT	11	QC TAB .187 SS 90°	10	JUMPER	9	QC TAB DBL SIDE 90° .250	8	QC TAB DBL SIDE 45° .250	7	QC TAB DBL SIDE FLAT .250	6	QC TAB DBL SIDE 90° .187	5	QC TAB DBL SIDE 45° .187	4	QC TAB DBL SIDE FLAT .187	3	QC TAB SGL SIDE 90° .250	2	QC TAB SGL SIDE 45° .250	1	QC TAB SGL SIDE FLAT .250	NO. OF POS.	PART NUMBER
POSITIONS LOADED																									

-	-	-	-	-	-	-	-	-	-	-	-	-	-	-	-	-	-	-	-	-	-	-	-	-	294.7	302.2	30	3-1546306-0		
-	-	-	-	-	-	-	-	-	-	-	-	-	-	-	-	-	-	-	-	-	-	-	-	-	-	285.2	292.7	29	2-1546306-9	
-	-	-	-	-	-	-	-	-	-	-	-	-	-	-	-	-	-	-	-	-	-	-	-	-	-	275.7	283.2	28	2-1546306-8	
-	-	-	-	-	-	-	-	-	-	-	-	-	-	-	-	-	-	-	-	-	-	-	-	-	-	266.2	273.7	27	2-1546306-7	
-	-	-	-	-	-	-	-	-	-	-	-	-	-	-	-	-	-	-	-	-	-	-	-	-	-	256.7	264.2	26	2-1546306-6	
-	-	-	-	-	-	-	-	-	-	-	-	-	-	-	-	-	-	-	-	-	-	-	-	-	-	247.2	254.7	25	2-1546306-5	
-	-	-	-	-	-	-	-	-	-	-	-	-	-	-	-	-	-	-	-	-	-	-	-	-	-	237.7	245.2	24	2-1546306-4	
-	-	-	-	-	-	-	-	-	-	-	-	-	-	-	-	-	-	-	-	-	-	-	-	-	-	228.2	235.7	23	2-1546306-3	
-	-	-	-	-	-	-	-	-	-	-	-	-	-	-	-	-	-	-	-	-	-	-	-	-	-	218.7	226.2	22	2-1546306-2	
-	-	-	-	-	-	-	-	-	-	-	-	-	-	-	-	-	-	-	-	-	-	-	-	-	-	209.2	216.7	21	2-1546306-1	
1	2	3	4	5	6	7	8	9	10	11	12	13	14	15	16	17	18	19	20	21	22	23	24	25	26	27	28	29	30	3-1546306-2
-	-	-	-	-	-	-	-	-	-	-	-	-	-	-	-	-	-	-	-	-	-	-	-	-	-	-	199.7	207.2	20	2-1546306-0
-	-	-	-	-	-	-	-	-	-	-	-	-	-	-	-	-	-	-	-	-	-	-	-	-	-	-	199.7	207.2	20	2-1546306-0
-	-	-	-	-	-	-	-	-	-	-	-	-	-	-	-	-	-	-	-	-	-	-	-	-	-	-	190.2	197.7	19	1-1546306-9
NOTES	13	QC TAB .187 SS FLAT	12	QC TAB .187 SS FLAT	11	QC TAB .187 SS 90°	10	JUMPER	9	QC TAB DBL SIDE 90° .250	8	QC TAB DBL SIDE 45° .250	7	QC TAB DBL SIDE FLAT .250	6	QC TAB DBL SIDE 90° .187	5	QC TAB DBL SIDE 45° .187	4	QC TAB DBL SIDE FLAT .187	3	QC TAB SGL SIDE 90° .250	2	QC TAB SGL SIDE 45° .250	1	QC TAB SGL SIDE FLAT .250	DIM B	DIM A	NO. OF POS.	PART NO.

1 2 SPL MARKING

THIS DRAWING IS A CONTROLLED DOCUMENT.		DWN S SCHLEGEL 20AUG2002	 TE Connectivity	
DIMENSIONS: MM		CHK C RICHARD 8/20/02		
TOLERANCES UNLESS OTHERWISE SPECIFIED:		APVD C RICHARD 8/20/02	NAME 9.50MM (.374) DBL ROW BARRIER STRIP W/O WASHER	
0 PLC ± - 1 PLC ± 0.3 2 PLC ± 0.25 3 PLC ± - 4 PLC ± - ANGLES ± 2°		PRODUCT SPEC -	SIZE A2	
MATERIAL		APPLICATION SPEC -	CAGE CODE 00779	DRAWING NO 1546306
FINISH		WEIGHT -	RESTRICTED TO -	SCALE NTS
		CUSTOMER DRAWING	SHEET 2 of 3	REV H2

THIS DRAWING IS UNPUBLISHED. RELEASED FOR PUBLICATION  
 © COPYRIGHT - By - ALL RIGHTS RESERVED.

LOC		DIST		REVISIONS			
P	LTR	DESCRIPTION	DATE	DWN	APVD		
-	-	SEE SHEET 1	-	-	-		

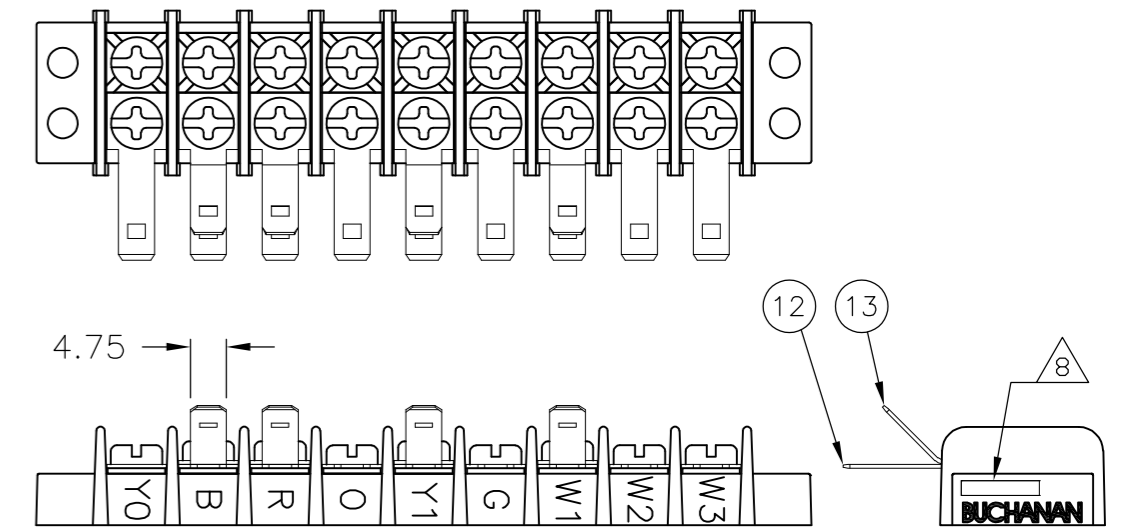
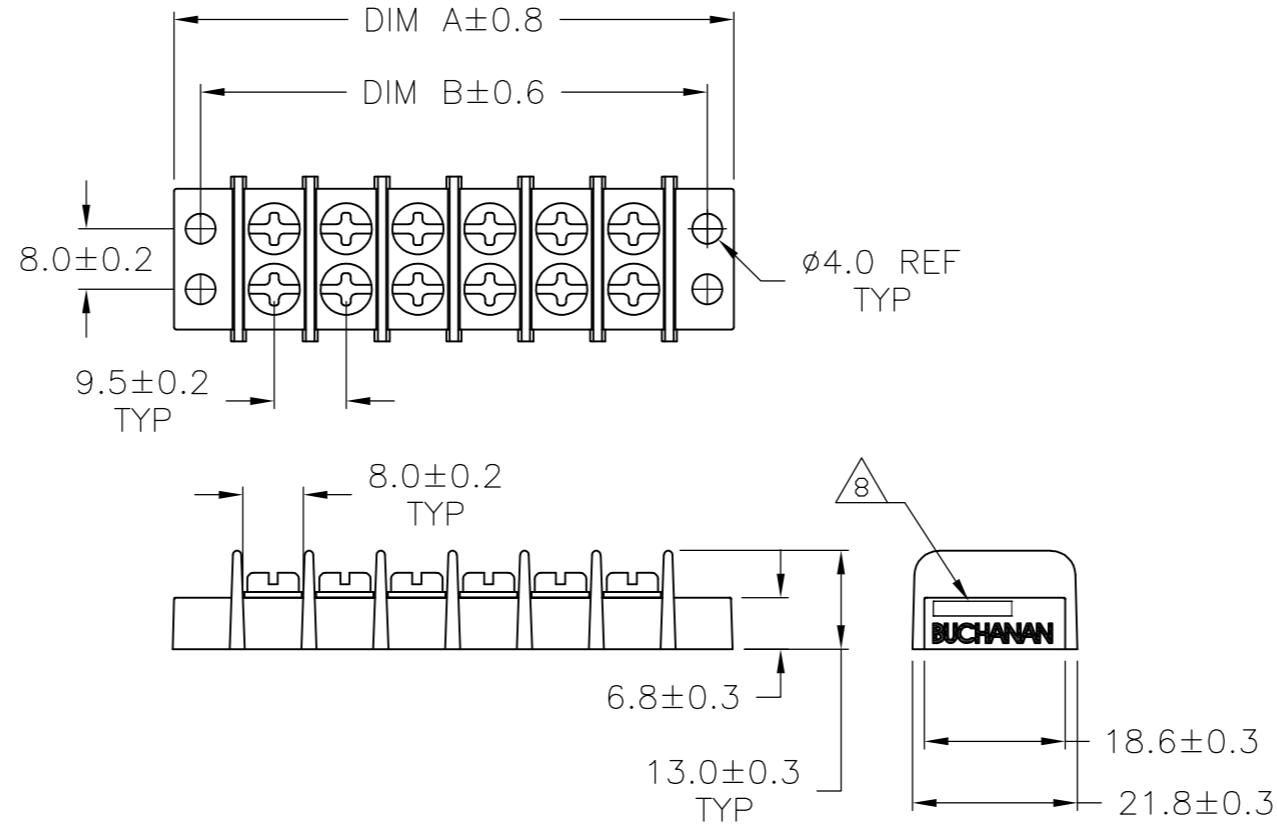

6-1546306-3

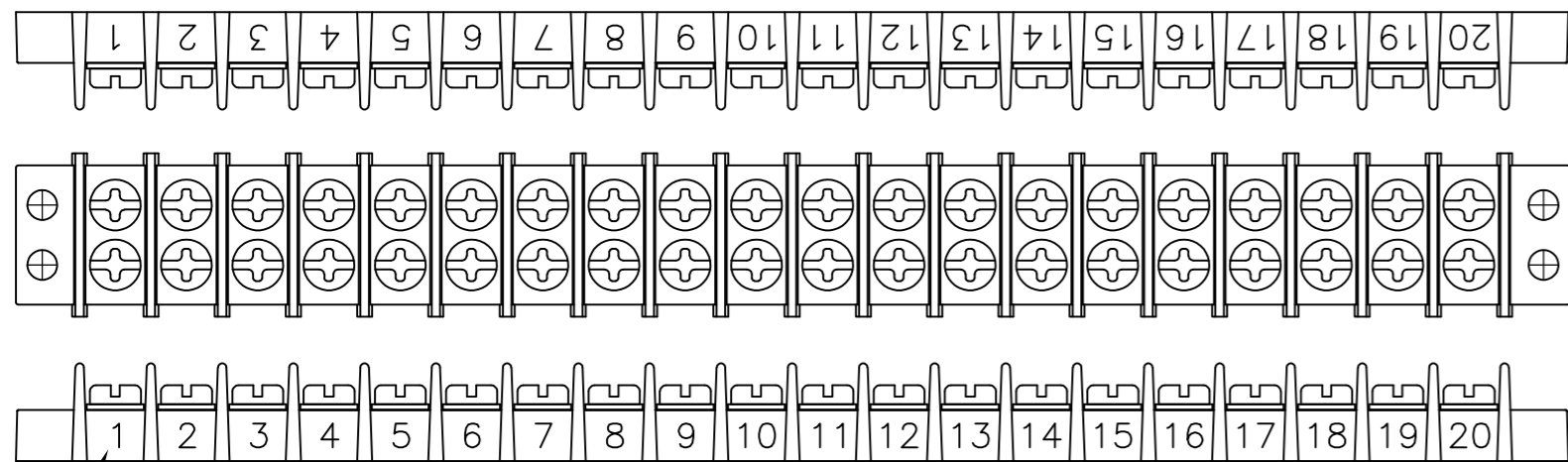

3-1546306-2

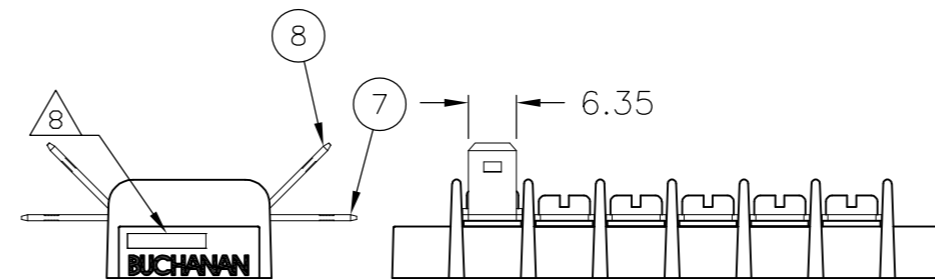

4-1546306-9

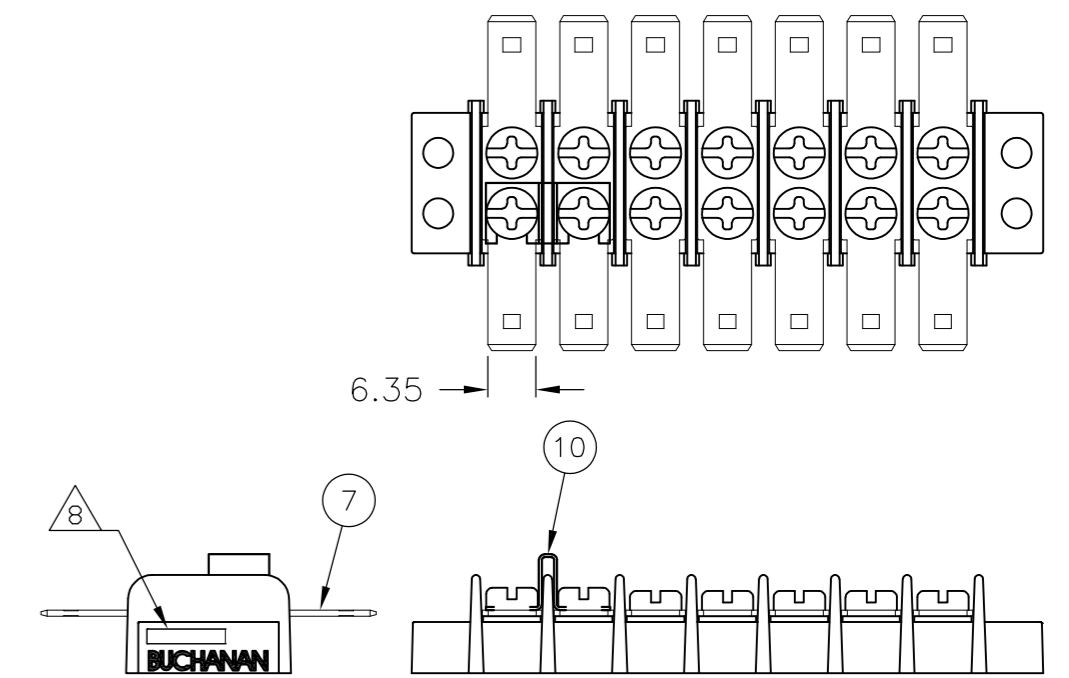

5-1546306-0

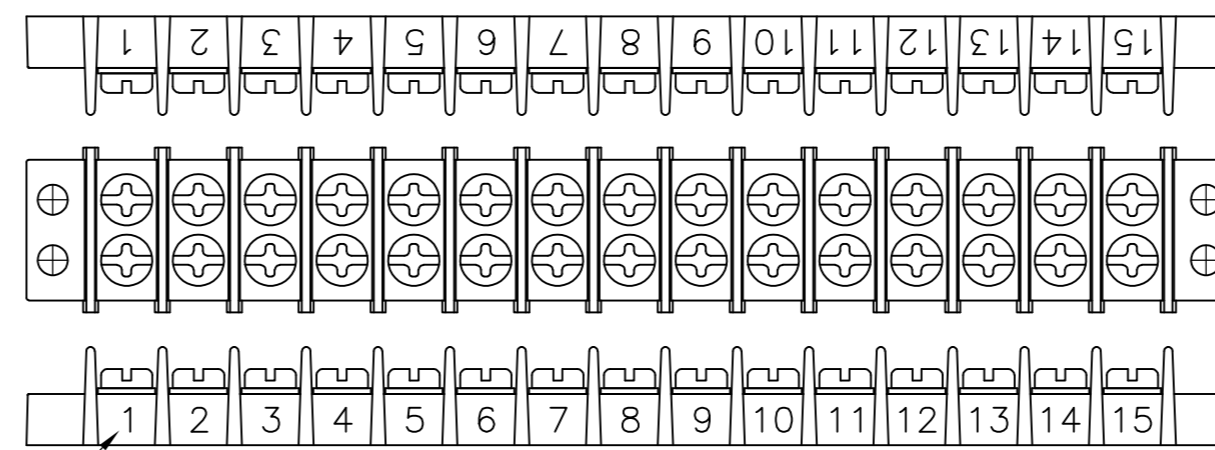
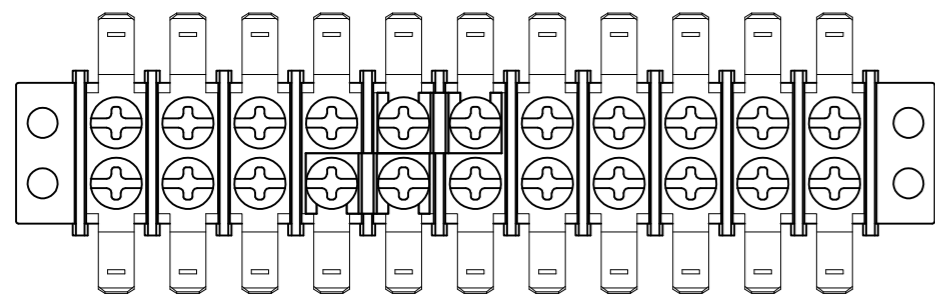

6-1546306-2

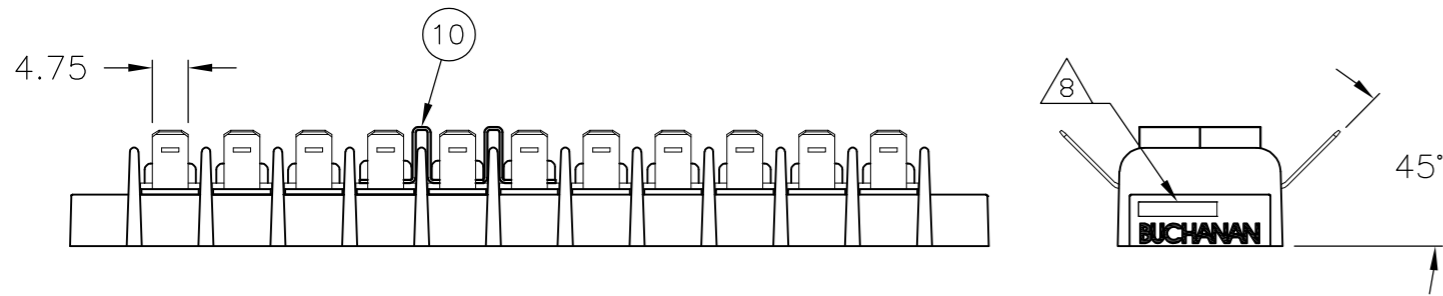

3-1546306-4

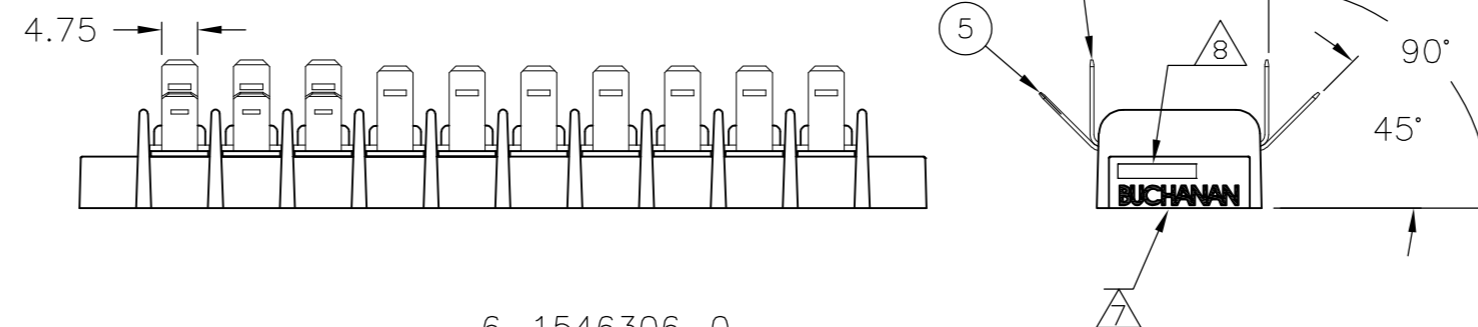

6-1546306-0

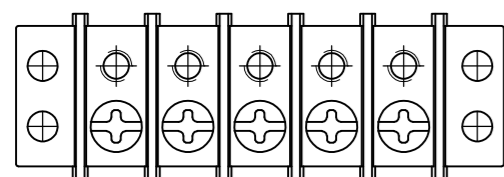

4-1546306-7

THIS DRAWING IS A CONTROLLED DOCUMENT.		DWN	20AUG2002						
		S	SCHLEGEL						
		CHK	8/20/02		TE Connectivity				
		C	RICHARD		NAME				
		APVD	8/20/02		9.50MM (.374) DBL ROW BARRIER STRIP				
		C	RICHARD		W/O WASHER				
		PRODUCT SPEC		-		SIZE	CAGE CODE	DRAWING NO	RESTRICTED TO
		APPLICATION SPEC		-		A2	00779	C=1546306	-
		MATERIAL		-		SCALE		SHEET	REV
		FINISH		-		NTS		3 OF 3	H2

Компания «Океан Электроники» предлагает заключение долгосрочных отношений при поставках импортных электронных компонентов на взаимовыгодных условиях!

Наши преимущества:

- Поставка оригинальных импортных электронных компонентов напрямую с производств Америки, Европы и Азии, а так же с крупнейших складов мира;
- Широкая линейка поставок активных и пассивных импортных электронных компонентов (более 30 млн. наименований);
- Поставка сложных, дефицитных, либо снятых с производства позиций;
- Оперативные сроки поставки под заказ (от 5 рабочих дней);
- Экспресс доставка в любую точку России;
- Помощь Конструкторского Отдела и консультации квалифицированных инженеров;
- Техническая поддержка проекта, помощь в подборе аналогов, поставка прототипов;
- Поставка электронных компонентов под контролем ВП;
- Система менеджмента качества сертифицирована по Международному стандарту ISO 9001;
- При необходимости вся продукция военного и аэрокосмического назначения проходит испытания и сертификацию в лаборатории (по согласованию с заказчиком);
- Поставка специализированных компонентов военного и аэрокосмического уровня качества (Xilinx, Altera, Analog Devices, Intersil, Interpoint, Microsemi, Actel, Aeroflex, Peregrine, VPT, Syfer, Eurofarad, Texas Instruments, MS Kennedy, Miteq, Cobham, E2V, MA-COM, Hittite, Mini-Circuits, General Dynamics и др.);

Компания «Океан Электроники» является официальным дистрибьютором и эксклюзивным представителем в России одного из крупнейших производителей разъемов военного и аэрокосмического назначения «JONHON», а так же официальным дистрибьютором и эксклюзивным представителем в России производителя высокотехнологичных и надежных решений для передачи СВЧ сигналов «FORSTAR».



## JONHON

«JONHON» (основан в 1970 г.)

Разъемы специального, военного и аэрокосмического назначения:

(Применяются в военной, авиационной, аэрокосмической, морской, железнодорожной, горно- и нефтедобывающей отраслях промышленности)

«FORSTAR» (основан в 1998 г.)

ВЧ соединители, коаксиальные кабели, кабельные сборки и микроволновые компоненты:

(Применяются в телекоммуникациях гражданского и специального назначения, в средствах связи, РЛС, а так же военной, авиационной и аэрокосмической отраслях промышленности).



Телефон: 8 (812) 309-75-97 (многоканальный)

Факс: 8 (812) 320-03-32

Электронная почта: [ocean@oceanchips.ru](mailto:ocean@oceanchips.ru)

Web: <http://oceanchips.ru/>

Адрес: 198099, г. Санкт-Петербург, ул. Калинина, д. 2, корп. 4, лит. А