

Digital Display (25 mm) M7E

Zero Suppression Incorporated

- Single-color (red or green) and two-color (red or green selectable) displays with a character height of 25 mm are available for a variety of applications and locations.
- Miniature design with a 43-mm depth is perfect for saving space in equipment and devices.
- A wide power supply range from 12 to 24 VDC.
- Connectors are available, which allows easy maintenance.
- Negative logic input.



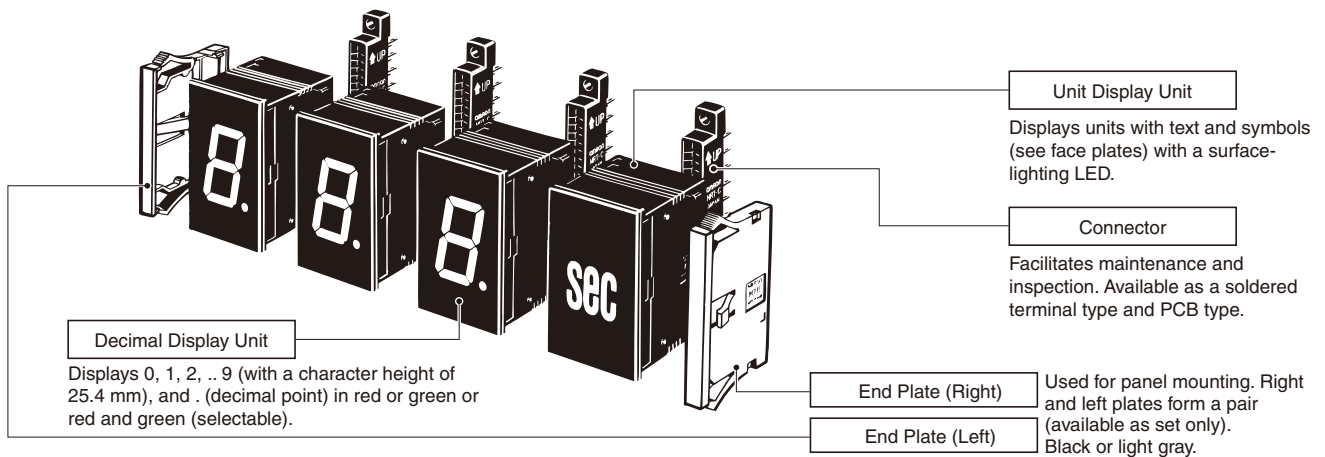

Model Configuration

■ Unit Configuration



Ordering Information

List of Models

Display contents	Display color	Type	Model
 Decimal	Red	Negative	M7E-02DRM2
	Green (See note 1.)		M7E-02DGN2
	Red/green (two colors) (See note 1.)		M7E-02DRGN2
 Unit	Red	---	M7E-02UR2-□ (See note 2.)
	Green	---	M7E-02UG2-□ (See note 2.)

Note: 1. The M7E-02DGN2 (single-color (green) model) is different from the M7E-02DRGN2 (two-color (red and green) model) in displayed tone.

2. The symbol in the box (□) expresses the code for the display contents. Refer to page 6.

Connectable PLCs

M7E model		PLC's output method		
Display contents	Type	Static output		Dynamic output
		PNP output	NPN output	
Decimal	Negative	Not connectable	Connectable	Not connectable
Unit	---	Connectable (only voltage imposed)		

Accessories (Order Separately)

End Plate

Case color	Model
Light gray	M7E-022M
Black	M7E-022M-1

Note: The Right and Left Plates form a pair.

Connector

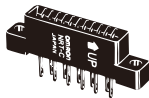
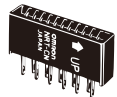
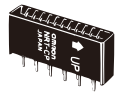
Terminal	Model
 Solder terminals	NRT-C
 Solder terminals	NRT-CN
 PCB terminals	NRT-CP

Specifications

Ratings

Rated power supply	Wide range from 12 to 24 VDC
Allowable voltage fluctuation range	90% to 110% of rated voltage
Current consumption (per display)	Red LED: 60 mA max. (at 24 VDC) 100 mA max. (at 12 VDC) Green LED: 80 mA max. (at 24 VDC) 140 mA max. (at 12 VDC)
Input level	High: 4 V to power supply voltage Low: 0 to 1.5 V
Negative logic	
Ambient temperature	Operating: -10°C to 55°C (with no icing) Storage: -25°C to 70°C (with no icing)
Ambient humidity	Operating: 35% to 85% (with no condensation)

Characteristics

Insulation resistance	100 MΩ min. (at 500 VDC) between each terminal and mounting panel
Dielectric strength	500 VAC, 50/60 Hz for 1 min between each terminal and mounting panel
Noise immunity (See note 2.)	Power terminal: ±500 V Input terminals: ±500 V (normal mode) ±1,500 V (common mode)
Vibration resistance	Destruction: 10 to 55 Hz, 0.75-mm double amplitude
Shock resistance	Destruction: 300 m/s ²
Degree of protection	IEC IP40 (portion on panel surface)
Compatible connector	OMRON NRT-C/NRT-CN/NRT-CP

Note: 1. Initial values

2. Impulse conditions:

Rise time: 1 ns +10% max.

Pulse width: 100 ns, 1 μs

Polarity: Positive, negative, asynchronous to power frequency, 100-Hz repeat frequency.

Installation

Terminal Arrangement/Functions

Terminal Arrangement Note: Values in parentheses apply to the NRT-□ Connector's pin numbers.

Decimal Display Unit

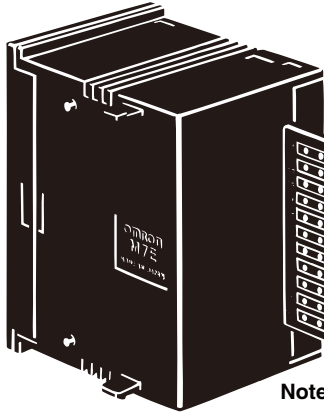

- NRT-□ Connector pin No.
- ⑪ V Power supply input (+)
 - ⑩ RBO— Zero suppress output
 - ⑨ RBI— Zero suppress input
 - ⑧ A — Data input (A... (2⁰))
 - ⑦ B — Data input (B... (2¹))
 - ⑥ C — Data input (C... (2²))
 - ⑤ D — Data input (D... (2³))
 - ④ DP — Decimal point input
 - ③ LE — Control input (latch input)
 - ② R/G — Control input (color selection input) (See note.)
 - ① G — Power supply input 0 V

Note: The R/G terminal is only for two-color models. It is NC on the single-color models.

Unit Display Unit

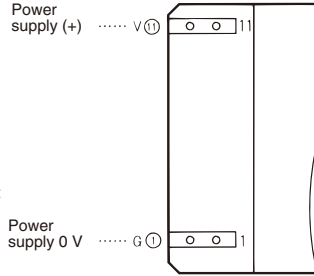

Block Diagram

Note: Circled numbers are the connector pin numbers.

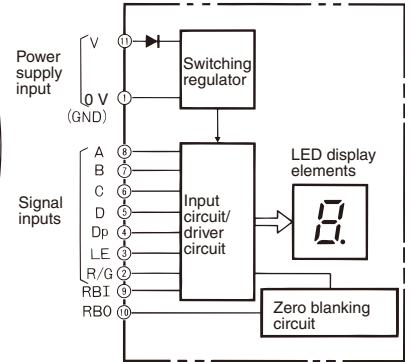

Terminal Functions

Terminal symbol	Name	Function
V	Power supply	Positive (+) power-supply terminal.
RBO	Control output	Low is output during zero blanking.
RBI	Control input	Turns OFF when the input is low while the decimal point is not lit and the contents of display is 0.
A B C D	Data inputs	<ul style="list-style-type: none"> • Displays a digit or symbol corresponding to the value of the binary code signal. • Decimal display uses 0 to 9; nothing will be displayed for higher values.
DP	Data input	The decimal point lights. Operates independently from the LE terminal.
LE	Control input	Latch input: The immediately preceding display condition is retained.
R/G	Control input	Set low for green display and high for red display. (See note.)
G	Power supply	0-V power-supply (ground) input terminal (GND).

Signal Input Circuit

Negative Logic Standard Model

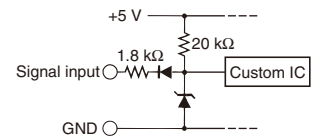

Note: Only for the M7E-02DRGN2.

Input Codes

Operation Examples of RBI and RBO

Zero suppression functions and RBO is low when the display is 0, the decimal point is not lit, and RBI is low.

Example 1: Zero blanking is not required and the RBI input and RBO output of each digit are open.

Example 2: Wired as shown when there is zero blanking. If the data of the rightmost digit is 0, 0 will be displayed.

Example 3: Zero blanking is valid for only the digits on the left of the lit digit and decimal point.

Example 4: Zero blanking is valid for the second digit and the following digits that are on the right of the lit digit and decimal point. If the first- to fourth-digit values are all 0 and the decimal point is lit with the fourth digit, 0.000 will be displayed. (There is no data in 000.)

Note: Use RBO output for the connection with RBI input only.

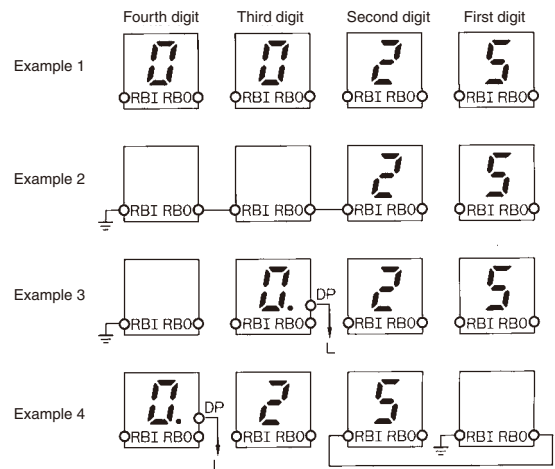

Negative Logic Unit

- The display color will be green if the color control input of terminal 2 is set low and red if it is set high.
- All inputs are pulled up internally. Therefore high can be open.

Connector pin No.	Input signal							Output	Output display condition	
	③	⑤	⑥	⑦	⑧	④	⑨			
Terminal symbol	LE	D	C	B	A	DP	RBI	RBO	Decimal	
Input signals	H	H	H	H	H	H	L	L	Blank	*2
	H	H	H	H	H	H	H	H	0	
	H	H	H	H	L	H	*1	H	1	
	H	H	H	L	H	H	*1	H	2	
	H	H	H	L	L	H	*1	H	3	
	H	H	L	H	H	H	*1	H	4	
	H	H	L	H	L	H	*1	H	5	
	H	H	L	L	H	H	*1	H	6	
	H	H	L	L	L	H	*1	H	7	
	H	L	H	H	H	H	*1	H	8	
	H	L	H	H	L	H	*1	H	9	
	H	L	H	L	H	H	*1	H	-	*3
	H	L	H	L	L	H	*1	H	Blank	
	H	L	L	H	H	H	*1	H	Blank	
	H	L	L	H	L	H	*1	H	Blank	
	H	L	L	L	H	H	*1	H	Blank	
	H	L	L	L	L	H	*1	H	Blank	
	*	*	*	*	*	L	*1	H	.	
H	H	H	H	H	L	*1	H	0	*2	
L	*1	*1	*1	*1	*1	*1	H	Retains the display conditions of A to D terminals before LE goes low. DP is not related.		

*1 Either low or high.

*2 Even if the data input is 0 and RBI is low, "0." will be displayed if DP is low.

*3 Indicates the minus symbol (-) on the 7-segment display.

External Connections

Refer to the *Block Diagram* on page 3 and *Terminal Arrangement/Functions* on page 3 before performing external connections for each Unit.

PLC Connections

Refer to your PLC operation manual before connecting the PLC.

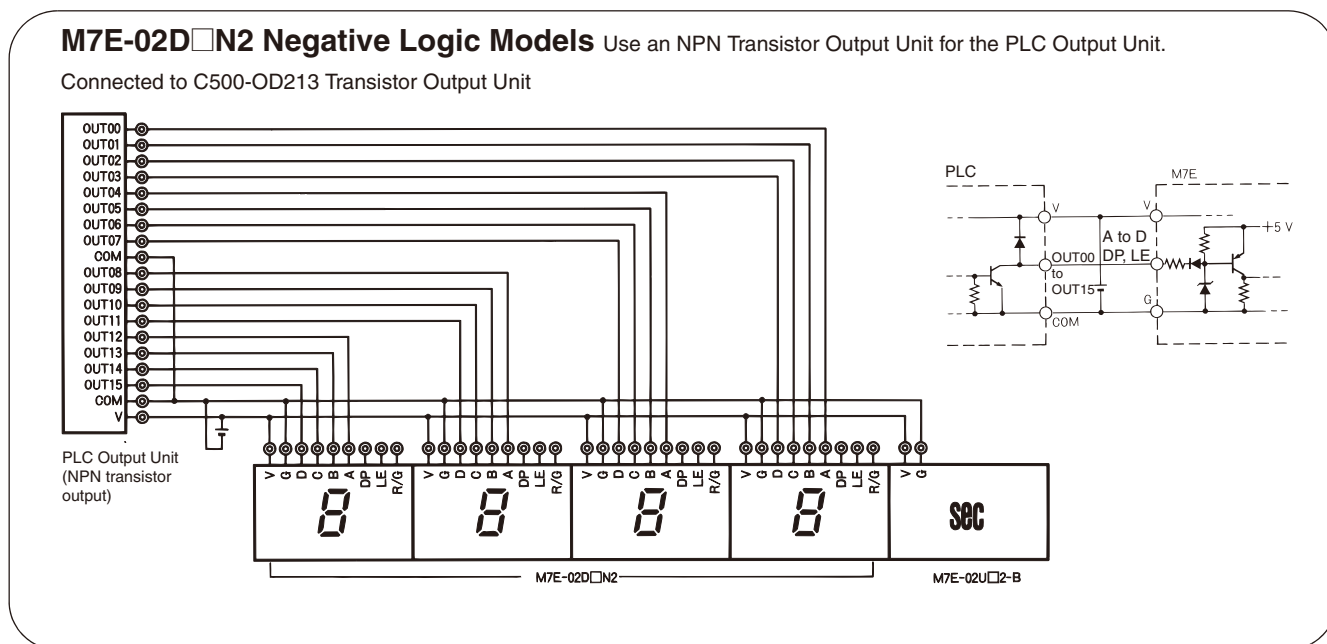

Operation

■ Operation Timing (Input Signal Timing)

Negative Logic

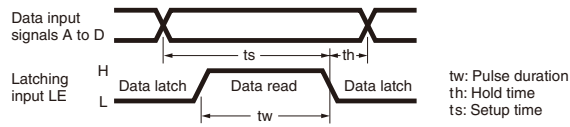

Pulse duration (tw)	1.5 ms min.
Hold time (th)	0.75 ms min.
Setup time (ts)	2.25 ms min.

■ Operation Chart

The following example shows the relationship between each input terminal and the display condition.

Data		0	1	2	3	4	5	6	7	8	9	Description	
Input signals	A (2 ⁰)	H	L	H	L	H	L	H	L	H	L	Inputs the data signal as BCD (or binary code)	
	B (2 ¹)	H	H	L	L	H	H	L	L	H	H		
	C (2 ²)	H	H	H	L	L	L	L	L	H	H		
	D (2 ³)	H	H	H	H	H	H	H	H	L	L		
	DP	H	L	L	L	L	L	L	L	L	H	H	Low when the decimal point lights. The decimal point can light without regard to the LE signal.
	LE	H	L	L	L	L	L	L	L	L	L	L	Keep low to retain the display. (The display from just before the signal goes low is retained.)
Display condition		0	1	2	3	4	5	6	7	8	9	---	
Remarks		The "1" display is retained by the LE signal.					The "5" display is retained by the LE signal.					---	

Dimensions

Note: All units are in millimeters unless otherwise indicated.

M7E-02□N2

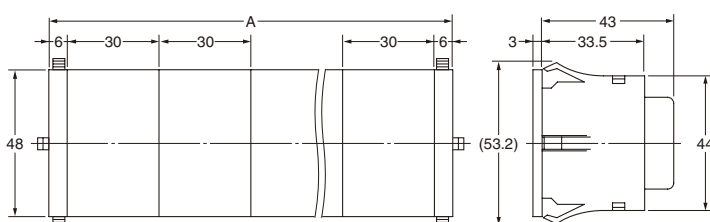
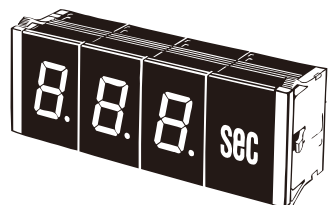

Panel Cutout

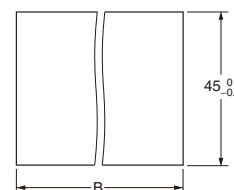

Panel thickness: 1 to 3 mm

LED

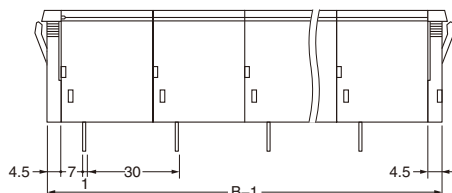
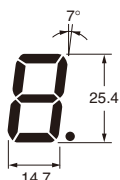

(Unit: mm)

Number of Units (n)	Dimension A (n x 30 + 12)	Dimension B (n x 30 + 10)
1	42±0.4	40±0.4
2	72±0.4	70±0.4
3	102±0.4	100±0.4
4	132±0.4	130±0.4
5	162±0.8	160±0.8
6	192±0.8	190±0.8
7	222±0.8	220±0.8
8	252±0.8	250±0.8

Note: 1. Dimensions A and B include End Plates.
2. Tolerance is ±0.4 mm unless otherwise specified.

Accessories (Order Separately)

End Plate

M7E-022M(-1)

Left End

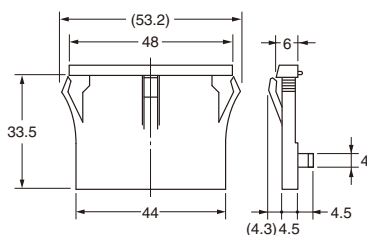

Right End

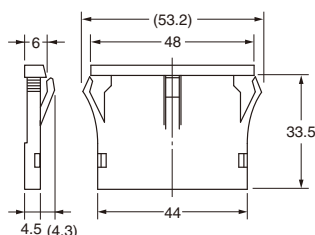

Face Plate

- A face plate is used with the Unit Display Unit, which incorporates a surface-lighting LED.
- The following face plates are available.
- Custom face plates can be made. Refer to the following for the procedure.

Symbol	A	B	C	F	G	H	J	JC1	K	V	Z1	Z2
Display contents	Blank display	sec	min	kg	mm	cm	m	m/min	°C	rpm	%	ppm

Safety Precautions

■ Precautions for Correct Use

Display Unit

Refer to *Safety Precautions for M7E*.

Procedure for Making Face Plates for M7E-02 Unit Display Unit

Custom face plates can be made according to the following guidelines.

1. Prepare a blank Unit Display Unit (M7E-02UR2-A or M7E-02UG2-A) for the desired lighting color.
2. Take transparent polyester film (with thickness equivalent to 0.188) and cut it to the following dimensions.

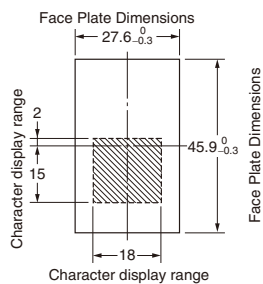

3. Print solid black on the film covering all area except the character and so that the desired unit character is within the character display range (with the unit character transparent).
4. Install the completed face plate into the Unit Display Unit.

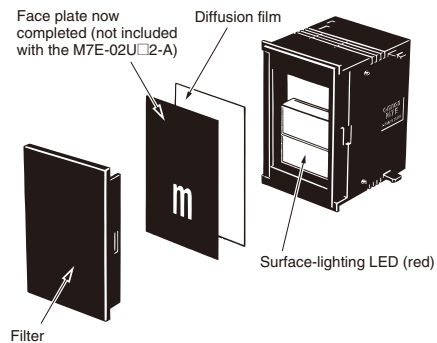

ALL DIMENSIONS SHOWN ARE IN MILLIMETERS.

To convert millimeters into inches, multiply by 0.03937. To convert grams into ounces, multiply by 0.03527.

In the interest of product improvement, specifications are subject to change without notice.

Safety Precautions for M7E

■ Precautions for Correct Use

Display Units

Installation environment

- Use the Unit in locations that are not subject to organic solvents (thinner, benzene, etc.), strong alkali, strong acid, sunlight, and corrosive gases.
- These Display Units are designed for indoor use only. Visibility may be significantly reduced if the Unit is used outside or in locations where the ambient brightness exceeds the brightness of the M7E. The product is not drip-proof. Use the product where it will not be subject to water or oil splashing.
- Use the Units in areas not subject to vibration or shock in excess of specifications.

Mounting

- Link the Units by snapping the projecting tips and slots together.

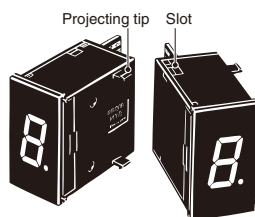

- To undo the linkage, use a slotted screwdriver as shown in the following figure and press the upper and lower tips while separating.

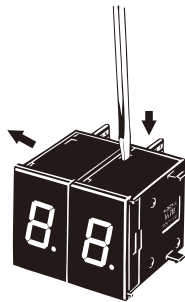

Connector Insertion

When inserting the connector, make sure that the UP arrow is pointing upwards.

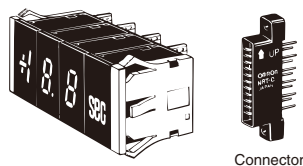

- When the End Plates are linked, the entire set can be quickly mounted and fastened to a panel. Confirm that the links between units and End Plates are secure, and then securely fasten the End Plate tips to the panel.

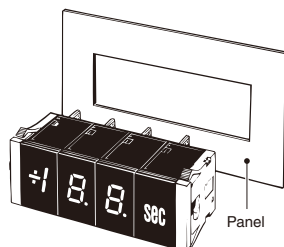

Wiring and Connections

Make sure that no wire is more than five meters long when wiring.

Handling

There are projecting tips made of resin on the side of each Display Unit. Be sure not to drop the Display Unit, otherwise the projecting tips may break.

Procedure for Making Face Plates for M7E-01 Unit Display Unit

Custom face plates can be made according to the following guidelines.

1. Prepare a blank Unit Display Unit (M7E-01UR2-A or M7E-01UG2-A) for the desired lighting color.
2. Take transparent polyester film (with thickness equivalent to 0.188) and cut it to the following dimensions.

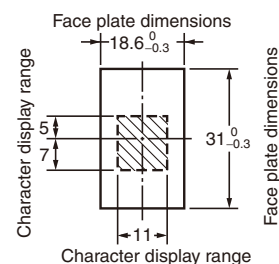

3. Print solid black on the film covering all areas except the character and so that the desired unit character is within the character display range (with the unit character transparent).
4. Install the completed face plate into the Unit Display Unit.

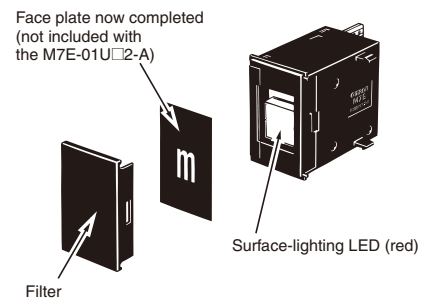

Mother Board

Wiring and Connections

Secure the cable and lead wires with the panel so that no excessive force will be imposed on the input connector or power supply terminals.

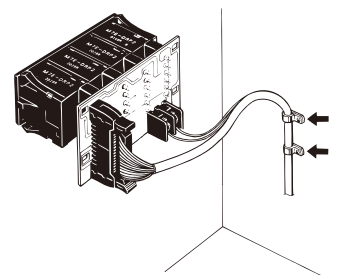

M7E Connection

- Connection of Mother Board and M7E

Mother board	Positive	Negative	Dynamic	
Static	○	○	× (See note.)	○: Possible
Dynamic	○	○	○	×: Impossible

Note: Do not connect the Mother Board static model to the M7E-01D□D2(-B) dynamic model, otherwise LE will be held.

- When using the M7E-01□□P2(-B) positive logic standard model, a pullup resistor may be required. Check the output circuit of the connecting device and use a pull-up resistor if necessary.
- All M7E models used on a single Mother Board must be identical.

Connecting or Disconnecting the M7E

When connecting the M7E to or disconnecting the M7E from the Mother Board, hold the front panel of the M7E or the case and be sure to apply appropriate force on the top and bottom of the Mother Board alternately.

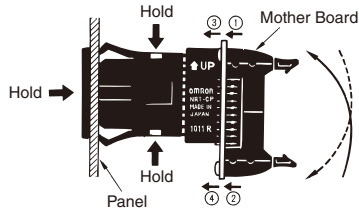

ALL DIMENSIONS SHOWN ARE IN MILLIMETERS.

To convert millimeters into inches, multiply by 0.03937. To convert grams into ounces, multiply by 0.03527.

In the interest of product improvement, specifications are subject to change without notice.

Read and Understand This Catalog

Please read and understand this catalog before purchasing the products. Please consult your OMRON representative if you have any questions or comments.

Warranty and Limitations of Liability

WARRANTY

OMRON's exclusive warranty is that the products are free from defects in materials and workmanship for a period of one year (or other period if specified) from date of sale by OMRON.

OMRON MAKES NO WARRANTY OR REPRESENTATION, EXPRESS OR IMPLIED, REGARDING NON-INFRINGEMENT, MERCHANTABILITY, OR FITNESS FOR PARTICULAR PURPOSE OF THE PRODUCTS. ANY BUYER OR USER ACKNOWLEDGES THAT THE BUYER OR USER ALONE HAS DETERMINED THAT THE PRODUCTS WILL SUITABLY MEET THE REQUIREMENTS OF THEIR INTENDED USE. OMRON DISCLAIMS ALL OTHER WARRANTIES, EXPRESS OR IMPLIED.

LIMITATIONS OF LIABILITY

OMRON SHALL NOT BE RESPONSIBLE FOR SPECIAL, INDIRECT, OR CONSEQUENTIAL DAMAGES, LOSS OF PROFITS, OR COMMERCIAL LOSS IN ANY WAY CONNECTED WITH THE PRODUCTS, WHETHER SUCH CLAIM IS BASED ON CONTRACT, WARRANTY, NEGLIGENCE, OR STRICT LIABILITY.

In no event shall responsibility of OMRON for any act exceed the individual price of the product on which liability is asserted.

IN NO EVENT SHALL OMRON BE RESPONSIBLE FOR WARRANTY, REPAIR, OR OTHER CLAIMS REGARDING THE PRODUCTS UNLESS OMRON'S ANALYSIS CONFIRMS THAT THE PRODUCTS WERE PROPERLY HANDLED, STORED, INSTALLED, AND MAINTAINED AND NOT SUBJECT TO CONTAMINATION, ABUSE, MISUSE, OR INAPPROPRIATE MODIFICATION OR REPAIR.

Application Considerations

SUITABILITY FOR USE

OMRON shall not be responsible for conformity with any standards, codes, or regulations that apply to the combination of products in the customer's application or use of the product.

At the customer's request, OMRON will provide applicable third party certification documents identifying ratings and limitations of use that apply to the products. This information by itself is not sufficient for a complete determination of the suitability of the products in combination with the end product, machine, system, or other application or use.

The following are some examples of applications for which particular attention must be given. This is not intended to be an exhaustive list of all possible uses of the products, nor is it intended to imply that the uses listed may be suitable for the products:

- Outdoor use, uses involving potential chemical contamination or electrical interference, or conditions or uses not described in this catalog.
- Nuclear energy control systems, combustion systems, railroad systems, aviation systems, medical equipment, amusement machines, vehicles, safety equipment, and installations subject to separate industry or government regulations.
- Systems, machines, and equipment that could present a risk to life or property.

Please know and observe all prohibitions of use applicable to the products.

NEVER USE THE PRODUCTS FOR AN APPLICATION INVOLVING SERIOUS RISK TO LIFE OR PROPERTY WITHOUT ENSURING THAT THE SYSTEM AS A WHOLE HAS BEEN DESIGNED TO ADDRESS THE RISKS, AND THAT THE OMRON PRODUCT IS PROPERLY RATED AND INSTALLED FOR THE INTENDED USE WITHIN THE OVERALL EQUIPMENT OR SYSTEM.

Disclaimers

CHANGE IN SPECIFICATIONS

Product specifications and accessories may be changed at any time based on improvements and other reasons.

It is our practice to change model numbers when published ratings or features are changed, or when significant construction changes are made. However, some specifications of the product may be changed without any notice. When in doubt, special model numbers may be assigned to fix or establish key specifications for your application on your request. Please consult with your OMRON representative at any time to confirm actual specifications of purchased product.

DIMENSIONS AND WEIGHTS

Dimensions and weights are nominal and are not to be used for manufacturing purposes, even when tolerances are shown.

ERRORS AND OMISSIONS

The information in this catalog has been carefully checked and is believed to be accurate; however, no responsibility is assumed for clerical, typographical, or proofreading errors, or omissions.

PERFORMANCE DATA

Performance data given in this catalog is provided as a guide for the user in determining suitability and does not constitute a warranty. It may represent the result of OMRON's test conditions, and the users must correlate it to actual application requirements. Actual performance is subject to the OMRON Warranty and Limitations of Liability.

PROGRAMMABLE PRODUCTS

OMRON shall not be responsible for the user's programming of a programmable product, or any consequence thereof.

COPYRIGHT AND COPY PERMISSION

This catalog shall not be copied for sales or promotions without permission.

This catalog is protected by copyright and is intended solely for use in conjunction with the product. Please notify us before copying or reproducing this catalog in any manner, for any other purpose. If copying or transmitting this catalog to another, please copy or transmit it in its entirety.

Mouser Electronics

Authorized Distributor

Click to View Pricing, Inventory, Delivery & Lifecycle Information:

[Omron:](#)

[NRTCN](#)

Компания «Океан Электроники» предлагает заключение долгосрочных отношений при поставках импортных электронных компонентов на взаимовыгодных условиях!

Наши преимущества:

- Поставка оригинальных импортных электронных компонентов напрямую с производств Америки, Европы и Азии, а так же с крупнейших складов мира;
- Широкая линейка поставок активных и пассивных импортных электронных компонентов (более 30 млн. наименований);
- Поставка сложных, дефицитных, либо снятых с производства позиций;
- Оперативные сроки поставки под заказ (от 5 рабочих дней);
- Экспресс доставка в любую точку России;
- Помощь Конструкторского Отдела и консультации квалифицированных инженеров;
- Техническая поддержка проекта, помощь в подборе аналогов, поставка прототипов;
- Поставка электронных компонентов под контролем ВП;
- Система менеджмента качества сертифицирована по Международному стандарту ISO 9001;
- При необходимости вся продукция военного и аэрокосмического назначения проходит испытания и сертификацию в лаборатории (по согласованию с заказчиком);
- Поставка специализированных компонентов военного и аэрокосмического уровня качества (Xilinx, Altera, Analog Devices, Intersil, Interpoint, Microsemi, Actel, Aeroflex, Peregrine, VPT, Syfer, Eurofarad, Texas Instruments, MS Kennedy, Miteq, Cobham, E2V, MA-COM, Hittite, Mini-Circuits, General Dynamics и др.);

Компания «Океан Электроники» является официальным дистрибьютором и эксклюзивным представителем в России одного из крупнейших производителей разъемов военного и аэрокосмического назначения «JONHON», а так же официальным дистрибьютором и эксклюзивным представителем в России производителя высокотехнологичных и надежных решений для передачи СВЧ сигналов «FORSTAR».



JONHON

«JONHON» (основан в 1970 г.)

Разъемы специального, военного и аэрокосмического назначения:

(Применяются в военной, авиационной, аэрокосмической, морской, железнодорожной, горно- и нефтедобывающей отраслях промышленности)

«FORSTAR» (основан в 1998 г.)

ВЧ соединители, коаксиальные кабели, кабельные сборки и микроволновые компоненты:

(Применяются в телекоммуникациях гражданского и специального назначения, в средствах связи, РЛС, а так же военной, авиационной и аэрокосмической отраслях промышленности).



Телефон: 8 (812) 309-75-97 (многоканальный)

Факс: 8 (812) 320-03-32

Электронная почта: ocean@oceanchips.ru

Web: <http://oceanchips.ru/>

Адрес: 198099, г. Санкт-Петербург, ул. Калинина, д. 2, корп. 4, лит. А