

Complementary N- and P-Channel 20 V (D-S) MOSFET

PRODUCT SUMMARY			
	V_{DS} (V)	$R_{DS(on)}$ (Ω)	I_D (mA)
N-Channel	20	0.70 at $V_{GS} = 4.5$ V	600
		0.85 at $V_{GS} = 2.5$ V	500
		1.25 at $V_{GS} = 1.8$ V	350
P-Channel	- 20	1.2 at $V_{GS} = - 4.5$ V	- 400
		1.6 at $V_{GS} = - 2.5$ V	- 300
		2.7 at $V_{GS} = - 1.8$ V	- 150

FEATURES

- Halogen-free According to IEC 61249-2-21 Definition
- TrenchFET® Power MOSFETs
- 2000 V ESD Protection
- Very Small Footprint
- High-Side Switching
- Low On-Resistance:
 - N-Channel, 0.7 Ω
 - P-Channel, 1.2 Ω
- Low Threshold: ± 0.8 V (Typ.)
- Fast Switching Speed: 14 ns
- 1.8 V Operation
- Compliant to RoHS Directive 2002/95/EC



RoHS
COMPLIANT
HALOGEN
FREE

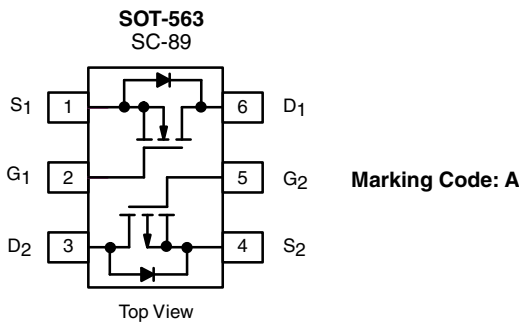

Ordering Information: Si1016X-T1-GE3 (Lead (Pb)-free and Halogen-free)

BENEFITS

- Ease in Driving Switches
- Low Offset (Error) Voltage
- Low-Voltage Operation
- High-Speed Circuits
- Low Battery Voltage Operation

APPLICATIONS

- Replace Digital Transistor, Level-Shifter
- Battery Operated Systems
- Power Supply Converter Circuits

ABSOLUTE MAXIMUM RATINGS ($T_A = 25$ °C, unless otherwise noted)							
Parameter	Symbol	N-Channel		P-Channel		Unit	
		5 s	Steady State	5 s	Steady State		
Drain-Source Voltage	V_{DS}	20		- 20		V	
Gate-Source Voltage	V_{GS}	± 6					
Continuous Drain Current ($T_J = 150$ °C) ^a	I_D	$T_A = 25$ °C	515	485	- 390	- 370	mA
		$T_A = 85$ °C	370	350	- 280	- 265	
Pulsed Drain Current ^b	I_{DM}	650		- 650			
Continuous Source Current (Diode Conduction) ^a	I_S	450	380	- 450	- 380	mW	
Maximum Power Dissipation ^a	P_D	$T_A = 25$ °C	280	250	280		250
		$T_A = 85$ °C	145	130	145		130
Operating Junction and Storage Temperature Range	T_J, T_{stg}	- 55 to 150				°C	
Gate-Source ESD Rating (HBM, Method 3015)	ESD	2000				V	

Notes:

a. Surface mounted on FR4 board.

b. Pulse width limited by maximum junction temperature.

SPECIFICATIONS ($T_J = 25\text{ }^\circ\text{C}$, unless otherwise noted)							
Parameter	Symbol	Test Conditions	Min.	Typ.	Max.	Unit	
Static							
Gate Threshold Voltage	$V_{GS(th)}$	$V_{DS} = V_{GS}, I_D = 250\text{ }\mu\text{A}$	N-Ch	0.45		1	V
		$V_{DS} = V_{GS}, I_D = -250\text{ }\mu\text{A}$	P-Ch	-0.45		-1	
Gate Body Leakage	I_{GSS}	$V_{DS} = 0\text{ V}, V_{GS} = \pm 4.5\text{ V}$	N-Ch P-Ch		± 0.5 ± 1.0	± 1.0 ± 2.0	μA
Zero Gate Voltage Drain Current	I_{DSS}	$V_{DS} = 16\text{ V}, V_{GS} = 0\text{ V}$	N-Ch		0.3	100	nA
		$V_{DS} = -16\text{ V}, V_{GS} = 0\text{ V}$	P-Ch		-0.3	-100	
		$V_{DS} = 16\text{ V}, V_{GS} = 0\text{ V}, T_J = 85\text{ }^\circ\text{C}$	N-Ch			5	μA
		$V_{DS} = -16\text{ V}, V_{GS} = 0\text{ V}, T_J = 85\text{ }^\circ\text{C}$	P-Ch			-5	
On State Drain Current ^a	$I_{D(on)}$	$V_{DS} = 5\text{ V}, V_{GS} = 4.5\text{ V}$	N-Ch	700			mA
		$V_{DS} = -5\text{ V}, V_{GS} = -4.5\text{ V}$	P-Ch	-700			
Drain-Source On-State Resistance ^a	$R_{DS(on)}$	$V_{GS} = 4.5\text{ V}, I_D = 600\text{ mA}$	N-Ch		0.41	0.70	Ω
		$V_{GS} = -4.5\text{ V}, I_D = -350\text{ mA}$	P-Ch		0.80	1.2	
		$V_{GS} = 2.5\text{ V}, I_D = 500\text{ mA}$	N-Ch		0.53	0.85	
		$V_{GS} = -2.5\text{ V}, I_D = -300\text{ mA}$	P-Ch		1.20	1.6	
		$V_{GS} = 1.8\text{ V}, I_D = 350\text{ mA}$	N-Ch		0.70	1.25	
		$V_{GS} = -1.8\text{ V}, I_D = -150\text{ mA}$	P-Ch		1.80	2.7	
Forward Transconductance ^a	g_{fs}	$V_{DS} = 10\text{ V}, I_D = 400\text{ mA}$	N-Ch		1.0		S
		$V_{DS} = -10\text{ V}, I_D = -250\text{ mA}$	P-Ch		0.4		
Diode Forward Voltage ^a	V_{SD}	$I_S = 150\text{ mA}, V_{GS} = 0\text{ V}$	N-Ch		0.8	1.2	V
		$I_S = -150\text{ mA}, V_{GS} = 0\text{ V}$	P-Ch		-0.8	-1.2	
Dynamic^b							
Total Gate Charge	Q_g	N-Channel $V_{DS} = 10\text{ V}, V_{GS} = 4.5\text{ V}, I_D = 250\text{ mA}$ P-Channel $V_{DS} = -10\text{ V}, V_{GS} = -4.5\text{ V}, I_D = -250\text{ mA}$	N-Ch		750		pC
Gate-Source Charge	Q_{gs}		N-Ch		75		
			P-Ch		150		
Gate-Drain Charge	Q_{gd}	N-Ch		225			
		P-Ch		450			
Turn-On Time	t_{ON}	N-Channel $V_{DD} = 10\text{ V}, R_L = 47\text{ }\Omega$ $I_D \cong 200\text{ mA}, V_{GEN} = 4.5\text{ V}, R_g = 10\text{ }\Omega$ P-Channel $V_{DD} = -10\text{ V}, R_L = 47\text{ }\Omega$ $I_D \cong -200\text{ mA}, V_{GEN} = -4.5\text{ V}, R_g = 10\text{ }\Omega$	N-Ch		5		ns
Turn-Off Time	t_{OFF}		N-Ch		25		
		P-Ch		35			

Notes:

- a. Pulse test; pulse width $\leq 300\text{ }\mu\text{s}$, duty cycle $\leq 2\%$.
b. Guaranteed by design, not subject to production testing.

Stresses beyond those listed under "Absolute Maximum Ratings" may cause permanent damage to the device. These are stress ratings only, and functional operation of the device at these or any other conditions beyond those indicated in the operational sections of the specifications is not implied. Exposure to absolute maximum rating conditions for extended periods may affect device reliability.

N-CHANNEL TYPICAL CHARACTERISTICS ($T_A = 25\text{ }^\circ\text{C}$, unless otherwise noted)

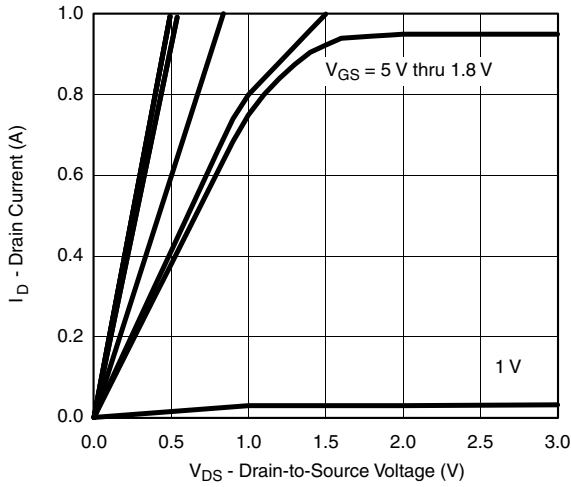

Output Characteristics

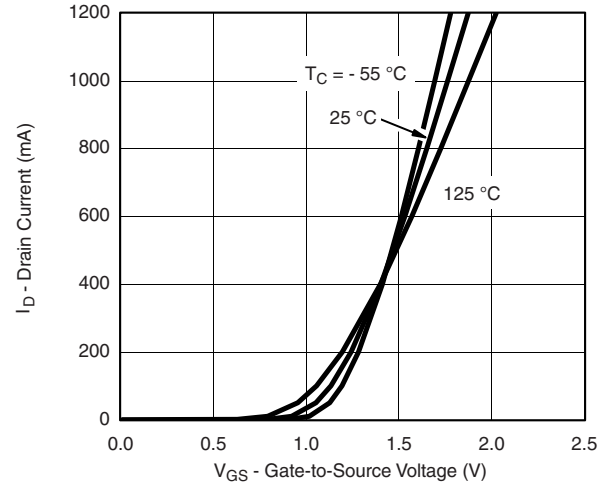

Transfer Characteristics

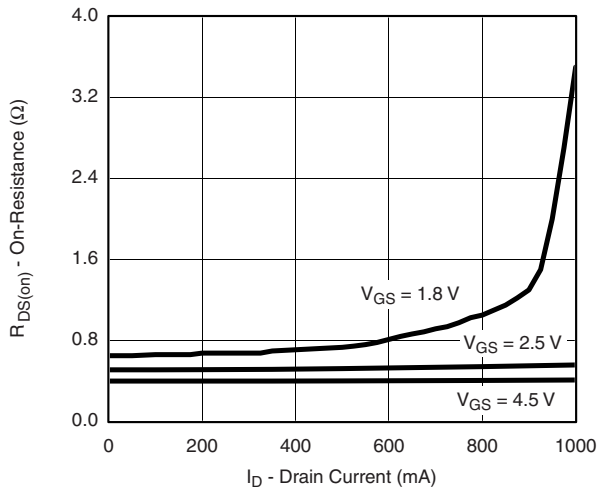

On-Resistance vs. Drain Current

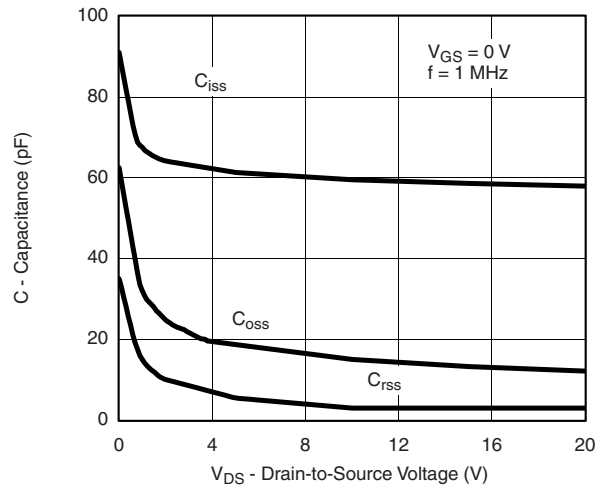

Capacitance

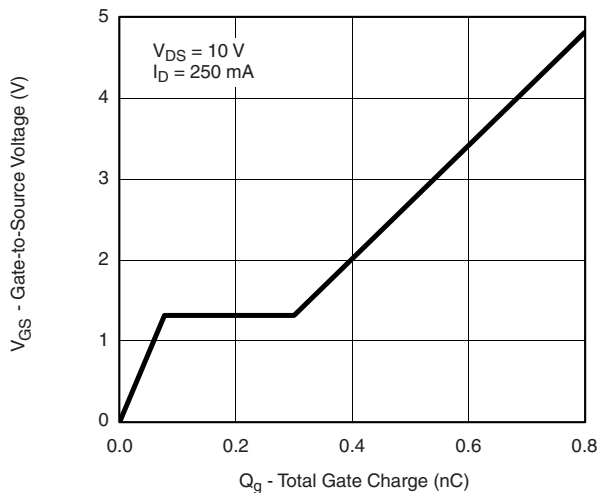

Gate Charge

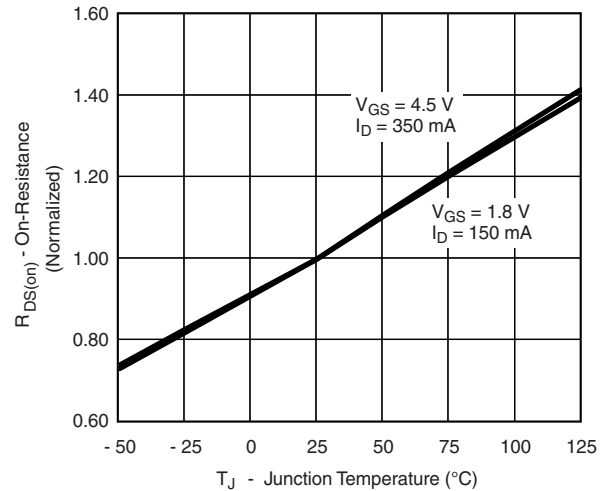

On-Resistance vs. Junction Temperature

N-CHANNEL TYPICAL CHARACTERISTICS ($T_A = 25\text{ }^\circ\text{C}$, unless otherwise noted)

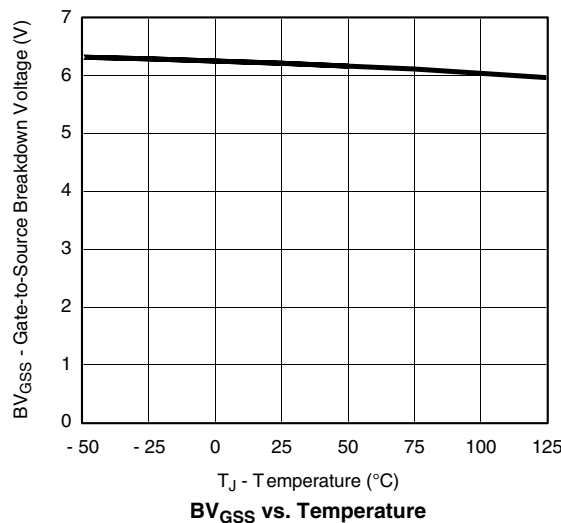
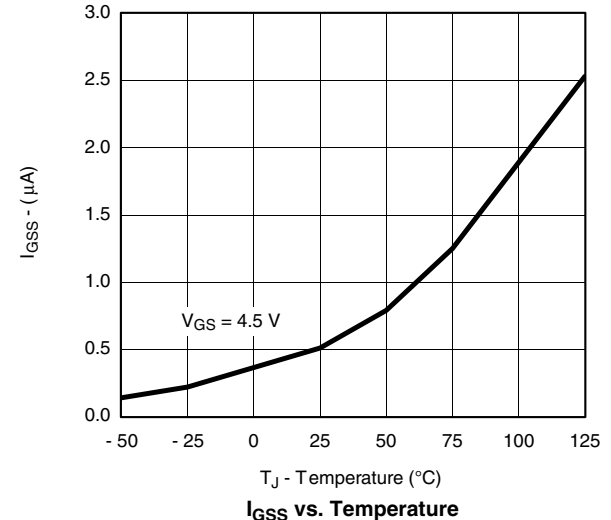
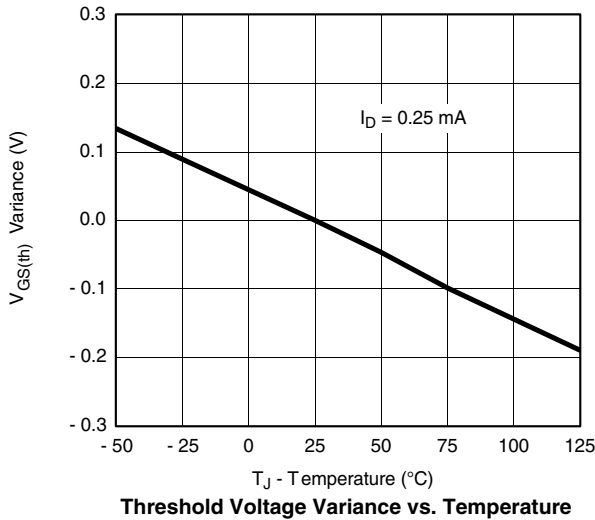
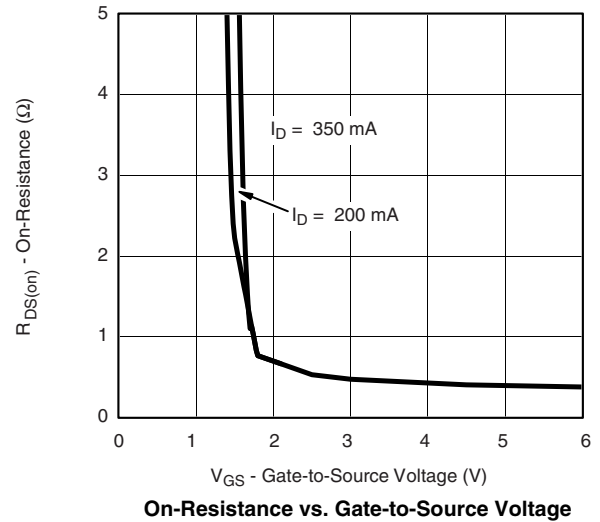
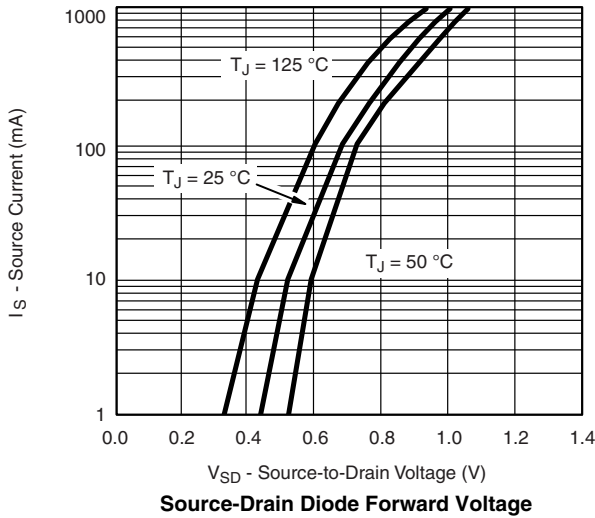

P-CHANNEL TYPICAL CHARACTERISTICS (T_A = 25 °C, unless otherwise noted)

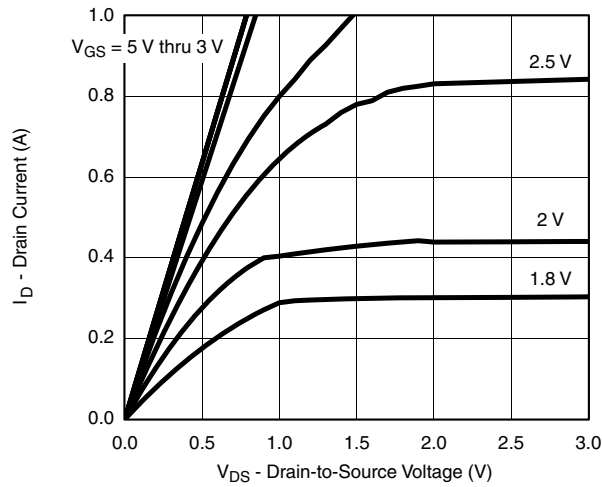

Output Characteristics

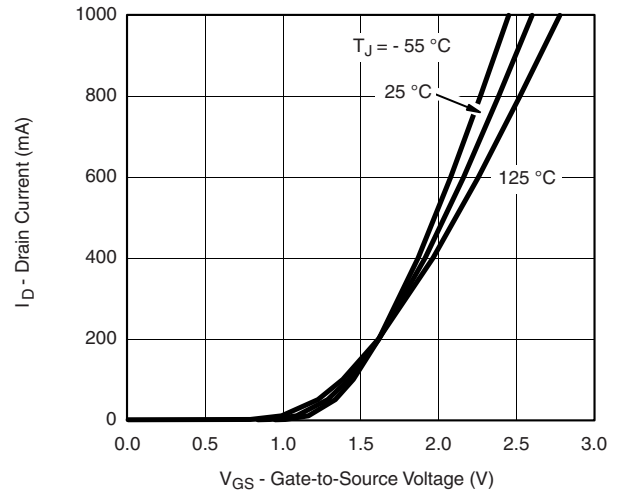

Transfer Characteristics

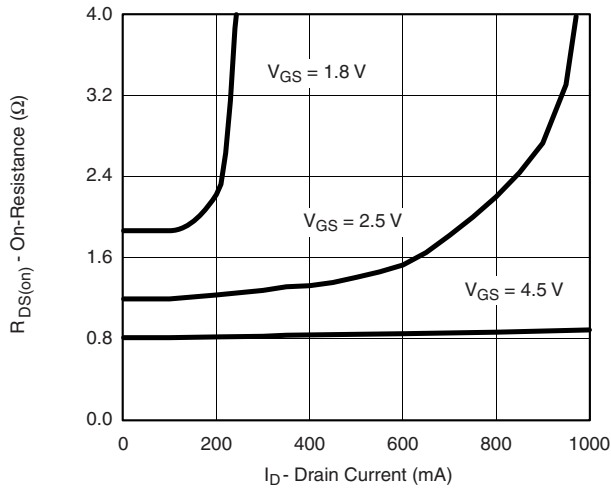

On-Resistance vs. Drain Current

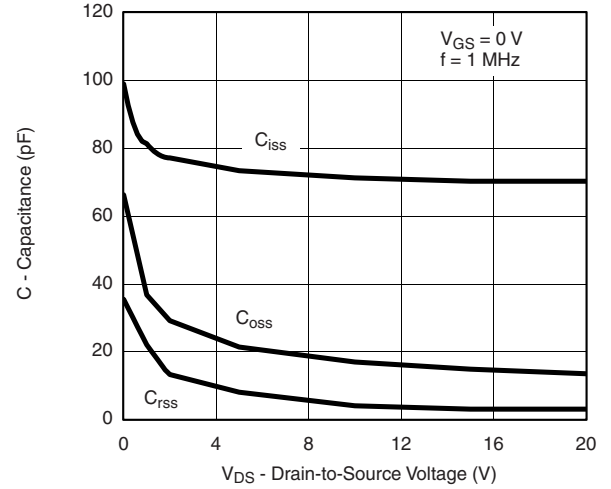

Capacitance

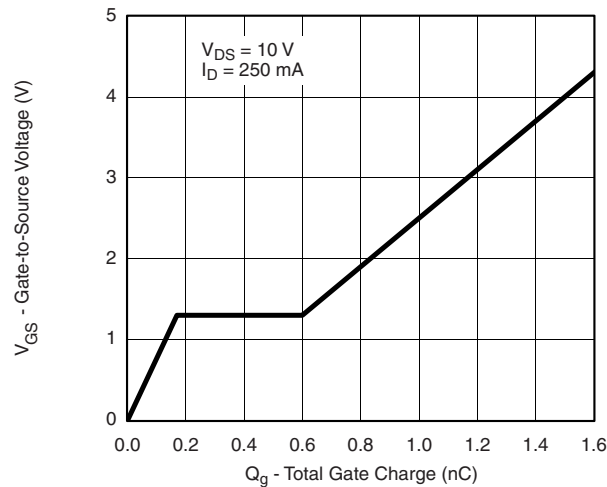

Gate Charge

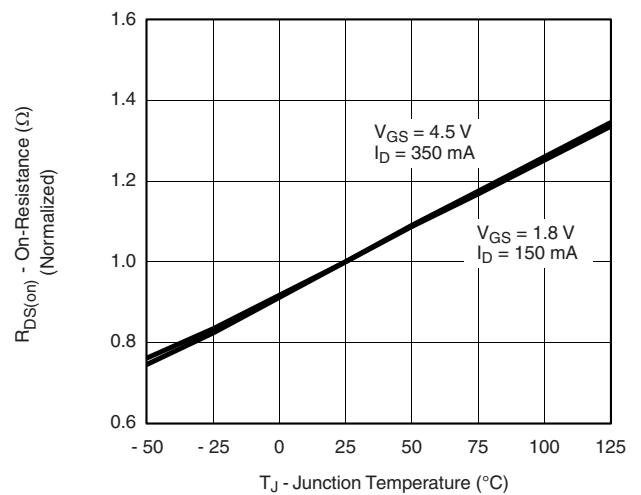

On-Resistance vs. Junction Temperature

P-CHANNEL TYPICAL CHARACTERISTICS ($T_A = 25\text{ }^\circ\text{C}$, unless otherwise noted)

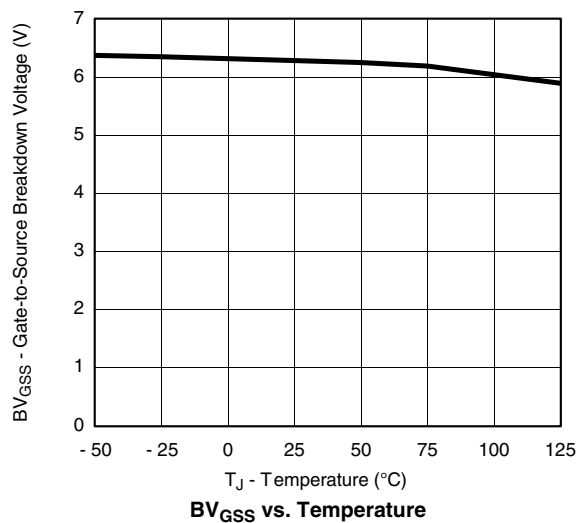
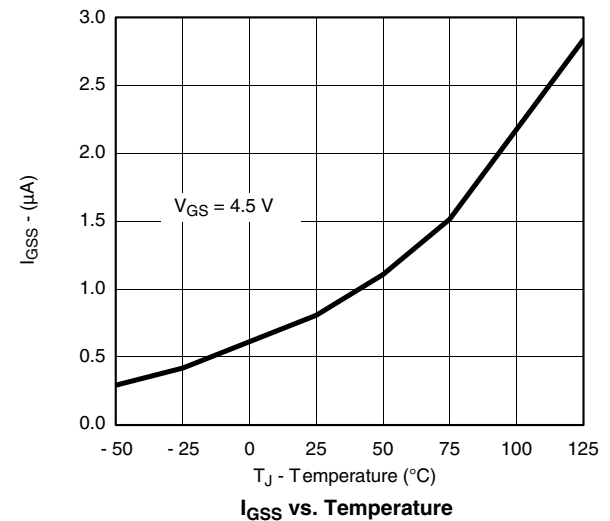
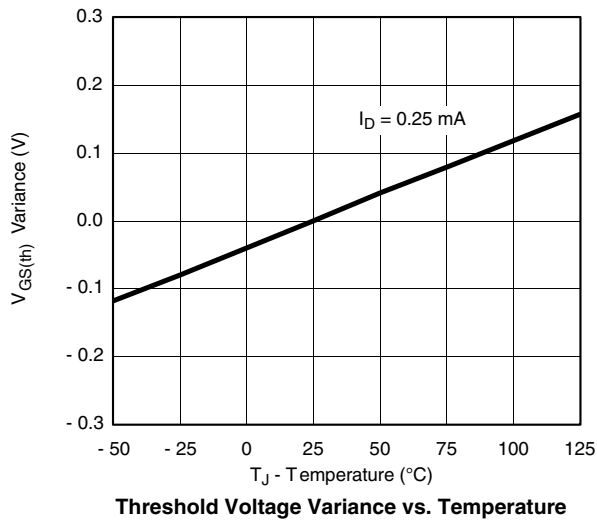
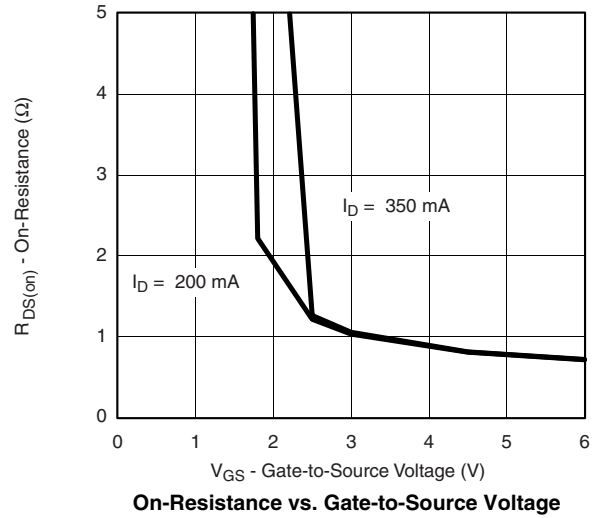
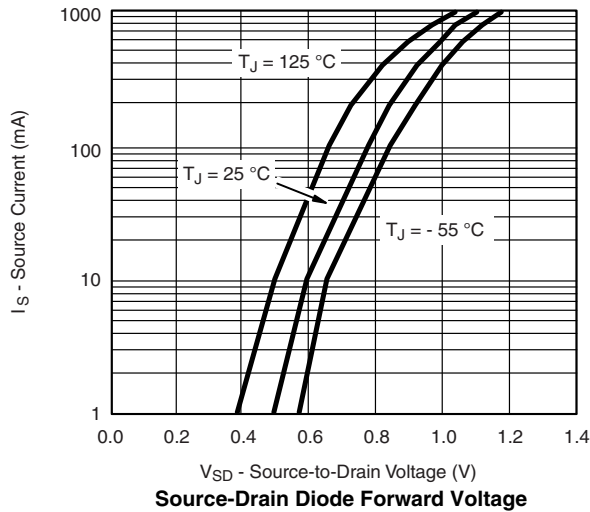

N- OR P-CHANNEL TYPICAL CHARACTERISTICS ($T_A = 25\text{ }^\circ\text{C}$, unless otherwise noted)

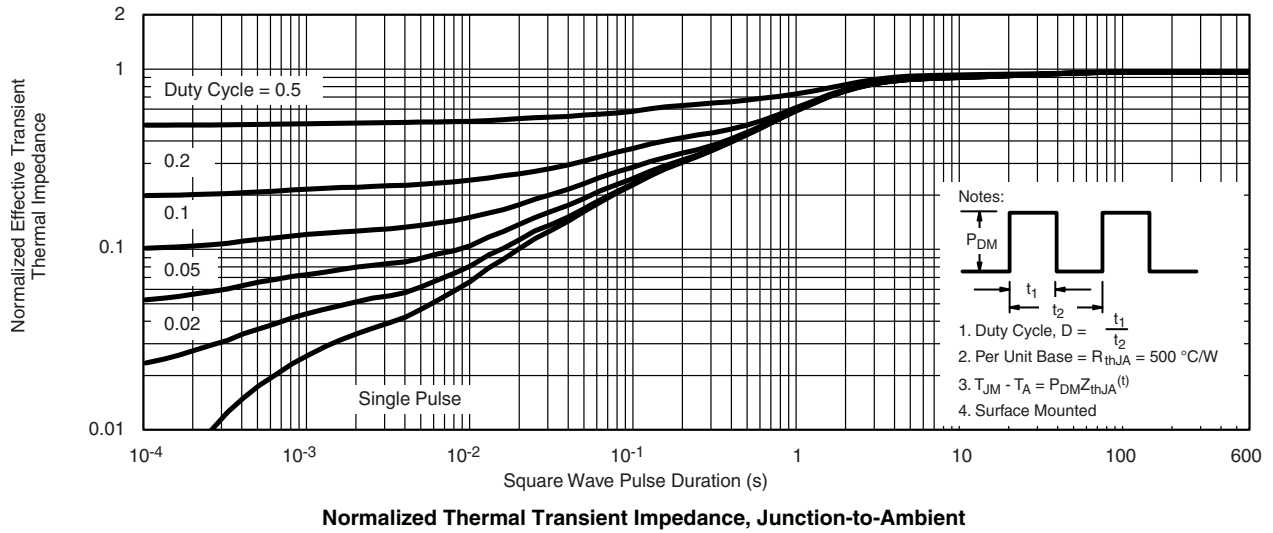

Vishay Siliconix maintains worldwide manufacturing capability. Products may be manufactured at one of several qualified locations. Reliability data for Silicon Technology and Package Reliability represent a composite of all qualified locations. For related documents such as package/tape drawings, part marking, and reliability data, see www.vishay.com/ppg?71168.

SC89: 6-LEADS (SOT-563F)

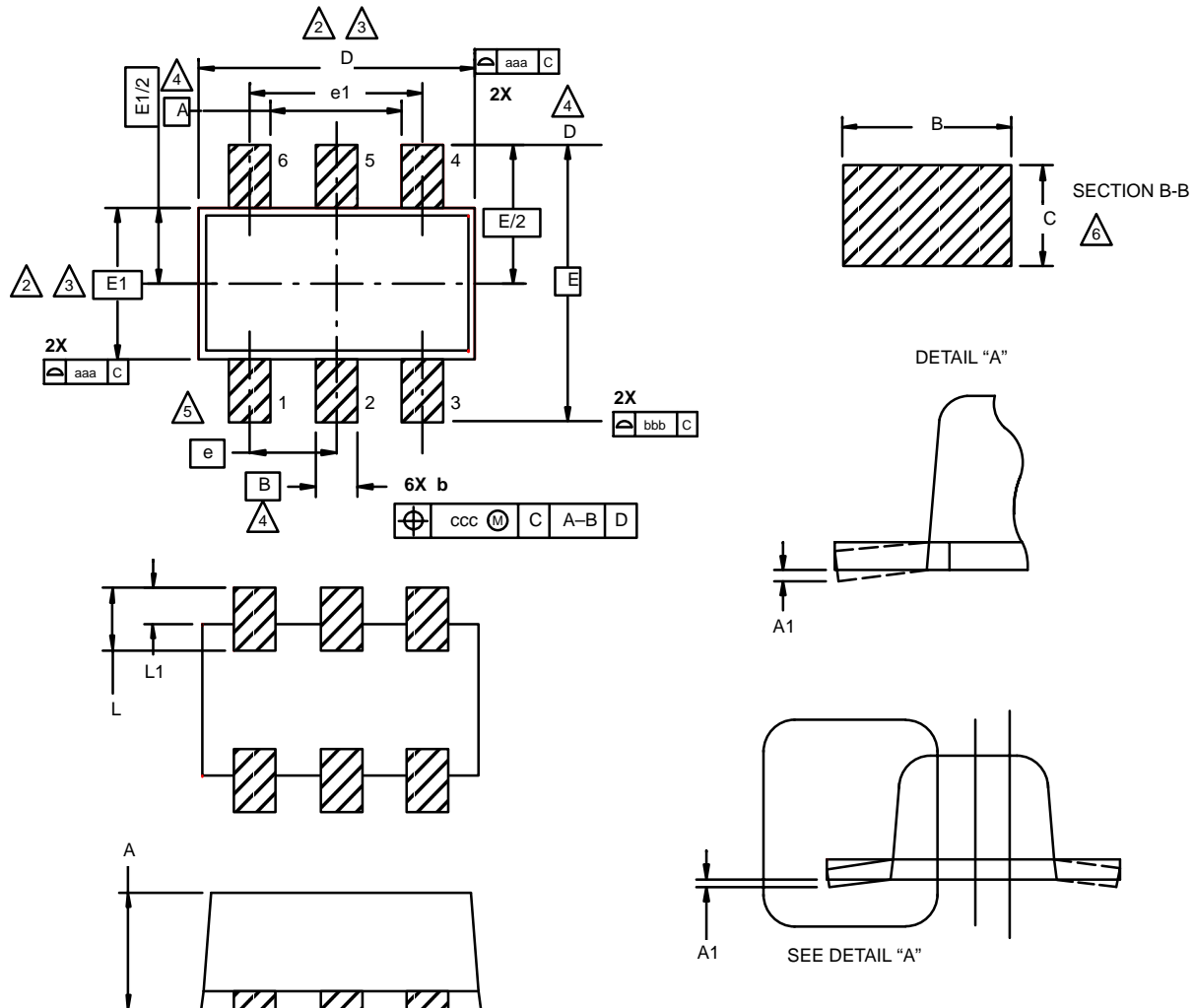

NOTES:

1. Dimensions in millimeters.

2 Dimension D does not include mold flash, protrusions or gate burrs. Mold flash, protrusions or gate burrs shall not exceed 0.15 mm per dimension $E1$ does not include interlead flash or protrusion, interlead flash or protrusion shall not exceed 0.15 mm per side.

3 Dimensions D and $E1$ are determined at the outmost extremes of the plastic body exclusive of mold flash, the bar burrs, gate burrs and interlead flash, but including any mismatch between the top and the bottom of the plastic body.

4 Datums A , B and D to be determined 0.10 mm from the lead tip.

5 Terminal numbers are shown for reference only.

6 These dimensions apply to the flat section of the lead between 0.08 mm and 0.15 mm from the lead tip.

Dim	MILLIMETERS		Note	Symbol	Tolerances Of Form And Position
	Min	Max			
A	0.56	0.60		aaa	0.10
A1	0.00	0.10		bbb	0.10
b	0.15	0.30		ccc	0.10
c	0.10	0.18			
D	1.50	1.70	2, 3		
E	1.55	1.70			
E1	1.20 BSC		2, 3		
e	0.50 BSC				
e1	1.00 BSC				
L	0.35 BSC				
L1	0.20 BSC				
ECN: E-00499—Rev. B, 02-Jul-01 DWG: 5880					

RECOMMENDED MINIMUM PADS FOR SC-89: 6-Lead



Recommended Minimum Pads
Dimensions in Inches/(mm)

[Return to Index](#)



Disclaimer

ALL PRODUCT, PRODUCT SPECIFICATIONS AND DATA ARE SUBJECT TO CHANGE WITHOUT NOTICE TO IMPROVE RELIABILITY, FUNCTION OR DESIGN OR OTHERWISE.

Vishay Intertechnology, Inc., its affiliates, agents, and employees, and all persons acting on its or their behalf (collectively, "Vishay"), disclaim any and all liability for any errors, inaccuracies or incompleteness contained in any datasheet or in any other disclosure relating to any product.

Vishay makes no warranty, representation or guarantee regarding the suitability of the products for any particular purpose or the continuing production of any product. To the maximum extent permitted by applicable law, Vishay disclaims (i) any and all liability arising out of the application or use of any product, (ii) any and all liability, including without limitation special, consequential or incidental damages, and (iii) any and all implied warranties, including warranties of fitness for particular purpose, non-infringement and merchantability.

Statements regarding the suitability of products for certain types of applications are based on Vishay's knowledge of typical requirements that are often placed on Vishay products in generic applications. Such statements are not binding statements about the suitability of products for a particular application. It is the customer's responsibility to validate that a particular product with the properties described in the product specification is suitable for use in a particular application. Parameters provided in datasheets and/or specifications may vary in different applications and performance may vary over time. All operating parameters, including typical parameters, must be validated for each customer application by the customer's technical experts. Product specifications do not expand or otherwise modify Vishay's terms and conditions of purchase, including but not limited to the warranty expressed therein.

Except as expressly indicated in writing, Vishay products are not designed for use in medical, life-saving, or life-sustaining applications or for any other application in which the failure of the Vishay product could result in personal injury or death. Customers using or selling Vishay products not expressly indicated for use in such applications do so at their own risk. Please contact authorized Vishay personnel to obtain written terms and conditions regarding products designed for such applications.

No license, express or implied, by estoppel or otherwise, to any intellectual property rights is granted by this document or by any conduct of Vishay. Product names and markings noted herein may be trademarks of their respective owners.

Material Category Policy

Vishay Intertechnology, Inc. hereby certifies that all its products that are identified as RoHS-Compliant fulfill the definitions and restrictions defined under Directive 2011/65/EU of The European Parliament and of the Council of June 8, 2011 on the restriction of the use of certain hazardous substances in electrical and electronic equipment (EEE) - recast, unless otherwise specified as non-compliant.

Please note that some Vishay documentation may still make reference to RoHS Directive 2002/95/EC. We confirm that all the products identified as being compliant to Directive 2002/95/EC conform to Directive 2011/65/EU.

Vishay Intertechnology, Inc. hereby certifies that all its products that are identified as Halogen-Free follow Halogen-Free requirements as per JEDEC JS709A standards. Please note that some Vishay documentation may still make reference to the IEC 61249-2-21 definition. We confirm that all the products identified as being compliant to IEC 61249-2-21 conform to JEDEC JS709A standards.

Компания «Океан Электроники» предлагает заключение долгосрочных отношений при поставках импортных электронных компонентов на взаимовыгодных условиях!

Наши преимущества:

- Поставка оригинальных импортных электронных компонентов напрямую с производств Америки, Европы и Азии, а так же с крупнейших складов мира;
- Широкая линейка поставок активных и пассивных импортных электронных компонентов (более 30 млн. наименований);
- Поставка сложных, дефицитных, либо снятых с производства позиций;
- Оперативные сроки поставки под заказ (от 5 рабочих дней);
- Экспресс доставка в любую точку России;
- Помощь Конструкторского Отдела и консультации квалифицированных инженеров;
- Техническая поддержка проекта, помощь в подборе аналогов, поставка прототипов;
- Поставка электронных компонентов под контролем ВП;
- Система менеджмента качества сертифицирована по Международному стандарту ISO 9001;
- При необходимости вся продукция военного и аэрокосмического назначения проходит испытания и сертификацию в лаборатории (по согласованию с заказчиком);
- Поставка специализированных компонентов военного и аэрокосмического уровня качества (Xilinx, Altera, Analog Devices, Intersil, Interpoint, Microsemi, Actel, Aeroflex, Peregrine, VPT, Syfer, Eurofarad, Texas Instruments, MS Kennedy, Miteq, Cobham, E2V, MA-COM, Hittite, Mini-Circuits, General Dynamics и др.);

Компания «Океан Электроники» является официальным дистрибьютором и эксклюзивным представителем в России одного из крупнейших производителей разъемов военного и аэрокосмического назначения «JONHON», а так же официальным дистрибьютором и эксклюзивным представителем в России производителя высокотехнологичных и надежных решений для передачи СВЧ сигналов «FORSTAR».



JONHON

«JONHON» (основан в 1970 г.)

Разъемы специального, военного и аэрокосмического назначения:

(Применяются в военной, авиационной, аэрокосмической, морской, железнодорожной, горно- и нефтедобывающей отраслях промышленности)

«FORSTAR» (основан в 1998 г.)

ВЧ соединители, коаксиальные кабели, кабельные сборки и микроволновые компоненты:

(Применяются в телекоммуникациях гражданского и специального назначения, в средствах связи, РЛС, а так же военной, авиационной и аэрокосмической отраслях промышленности).



Телефон: 8 (812) 309-75-97 (многоканальный)

Факс: 8 (812) 320-03-32

Электронная почта: ocean@oceanchips.ru

Web: <http://oceanchips.ru/>

Адрес: 198099, г. Санкт-Петербург, ул. Калинина, д. 2, корп. 4, лит. А